

Operation Guide 3499



ENGLISH

Congratulations upon your selection of this CASIO watch.

To ensure that this watch provides you with the years of service for which it is designed, carefully read and follow the instructions in this manual, especially the information under "Operating Precautions" and "User Maintenance".

Applications

The built-in sensors of this watch measure direction, barometric pressure, temperature and altitude. Measured values are then shown on the display. Such features make this watch useful when hiking, mountain climbing, or when engaging in other such outdoor activities.

Warning !

- The measurement functions built into this watch are not intended for taking measurements that require professional or industrial precision. Values produced by this watch should be considered as reasonable representations only.
- When engaging in mountain climbing or other activities in which losing your way can create a dangerous or life-threatening situation, always use a second compass to confirm direction readings.
- Note that CASIO COMPUTER CO., LTD. assumes no responsibility for any damage or loss suffered by you or any third party arising through the use of this product or its malfunction.

Important!

- The watch's Altimeter Mode calculates and displays relative altitude based on barometric pressure readings produced by its pressure sensor. This means that readings taken at different times at the same location may produce different altitude values due to changes in barometric pressure. Also note that the value displayed by the watch may be different from the actual elevation and/or sea level elevation indicated for the area where you are located.
- When using the altimeter of this watch for mountain climbing or other activities, it is highly recommended that you check a map, local altitude indications, or some other source for your current correct altitude and regularly calibrate the altimeter with the latest information. For more information, see "To specify a reference altitude value" (page E-55).
- Whenever you use the digital compass of this watch for serious trekking, mountain climbing, or other activities, be sure always to take along another compass to confirm readings. If the readings produced by the digital compass of this watch are different from those of the other compass, perform bidirectional calibration of the digital compass to ensure more accurate readings.
- Direction readings and digital compass calibration will not be possible if the watch is in the vicinity of a permanent magnet (magnetic accessory, etc.), metal objects, high-voltage wires, aerial wires, or electrical household appliances (TV, computer, cellphone, etc.)

E

E-1

About This Manual



- Depending on the model of your watch, digital display text appears either as dark figures on a light background, or light figures on a dark background. All examples in this manual are shown using dark figures on a light background.
- Button operations are indicated using the letters shown in the illustration.
- Note that the product illustrations in this manual are intended for reference only, and so the actual product may appear somewhat different than depicted by an illustration.

E-2

E-3

2. Check the Home City and the daylight saving time (DST) setting.

Use the procedure under "To configure Home City and summer time settings" (page E-20) to configure your Home City and daylight saving time settings.

Important!

- World Time Mode and Sunrise/Sunset Mode data depend on correct Home City, time, and date settings in the Timekeeping Mode. Make sure you configure these settings correctly.

3. Set the current time.

- To set the time
See "Configuring Current Time and Date Settings" (page E-22).

The watch is now ready for use.

E-4

E-5

Specifying Temperature, Barometric Pressure, and Altitude Display Units E-36
To specify temperature, barometric pressure, and altitude display units E-36

Taking Barometric Pressure and Temperature Readings E-38
To take barometric pressure and temperature readings E-38
To enable or disable the barometric pressure change alert E-44
To calibrate the pressure sensor and the temperature sensor E-46

Using the Altimeter Mode E-48
To select the altitude screen format E-50
To select the altitude auto reading interval E-51
To take altitude readings E-53
To specify a reference altitude value E-55
To specify the altitude differential start point E-57
To use the altitude differential value E-58
To save a reading manually E-59
To start trek log value updating E-62
To stop trek log value updating E-62

Viewing Altitude Records E-67
To view altitude records E-67
To delete all manually saved data E-72
To delete data in a specific memory area E-72

E-6

Things to check before using the watch

1. Check the battery power level.

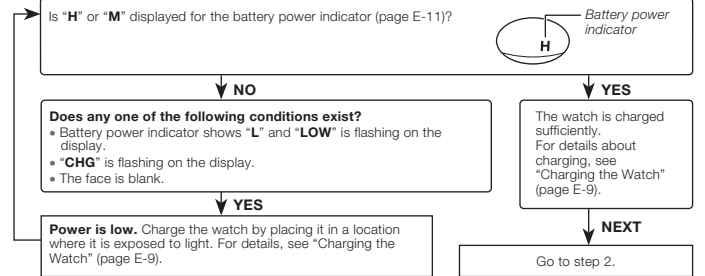

Contents

About This Manual E-2

Things to check before using the watch E-3

Charging the Watch E-9
To recover from the sleep state E-14

Mode Reference Guide E-15

Timekeeping E-19

Configuring Home City Settings E-20
To configure Home City and summer time settings E-20

Configuring Current Time and Date Settings E-22
To change the current time and date settings E-22

Taking Direction Readings E-25
To take a direction reading E-25
To perform bidirectional calibration E-29
To perform magnetic declination correction E-30
To store a direction angle reading in Bearing Memory E-31

Looking up Sunrise and Sunset Times E-74
To enter the Sunrise/Sunset Mode E-74
To view the sunrise/sunset time for a particular date E-75
To look up the sunrise and sunset times for a specific location E-76

Using the Stopwatch E-78
To enter the Stopwatch Mode E-78
To perform an elapsed time operation E-78
To pause at a split time E-78
To measure two finishes E-79

Using the Countdown Timer E-80
To enter the Countdown Timer Mode E-80
To specify the countdown start time E-80
To perform a countdown timer operation E-81
To stop the alarm E-81

Using the Alarm E-82
To enter the Alarm Mode E-82
To set an alarm time E-83
To turn an alarm and the Hourly Time Signal on and off E-84
To stop the alarm E-85

E-7

Checking the Current Time in a Different Time Zone	E-86
To enter the World Time Mode	E-86
To view the time in another time zone	E-86
To specify standard time or daylight saving time (DST) for a city	E-87
Illumination	E-88
To turn on illumination manually	E-88
To change the illumination duration	E-88
To turn the auto light switch on and off	E-90
Other Settings	E-92
To turn the button operation tone on and off	E-92
To turn Power Saving on or off	E-93
Troubleshooting	E-94
Specifications	E-99
Operating Precautions	E-103
User Maintenance	E-110

Charging the Watch

The face of the watch is a solar panel that generates power from light. The generated power charges a built-in rechargeable battery, which powers watch operations. The watch charges whenever it is exposed to light.

Charging Guide



Whenever you are not wearing the watch, leave it in a location where it is exposed to light.

- Best charging performance is achieved by exposing the watch to the strongest light available.

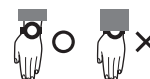

When wearing the watch, make sure that its face is not blocked from light by the sleeve of your clothing.

- The watch may enter a sleep state (page E-14) if its face is blocked by your sleeve even only partially.

E-8

E-9

Warning!

Leaving the watch in bright light for charging can cause it to become quite hot. Take care when handling the watch to avoid burn injury. The watch can become particularly hot when exposed to the following conditions for long periods.

- On the dashboard of a car parked in direct sunlight
- Too close to an incandescent lamp
- Under direct sunlight

Important!

- Allowing the watch to become very hot can cause its liquid crystal display to black out. The appearance of the LCD should become normal again when the watch returns to a lower temperature.
- Turn on the watch's Power Saving function (page E-14) and keep it in an area normally exposed to bright light when storing it for long periods. This helps to ensure that power does not run down.
- Storing the watch for long periods in an area where there is no light or wearing it in such a way that it is blocked from exposure to light can cause power to run down. Expose the watch to bright light whenever possible.

E-10

E-11

Power Levels

You can get an idea of the watch's power level by observing the battery power indicator on the display.

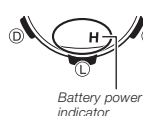

Level	Battery Power Indicator	Function Status
1 (H)		All functions enabled.
2 (M)		All functions enabled.
3 (L)		Illumination, beeper, and sensor operation disabled.
4 (CHG)		Except for the current time and the CHG (charge) indicator, all functions and display indicators disabled.
5	---	All functions disabled.

- The flashing **LOW** indicator at Level 3 (L) tells you that battery power is very low, and that exposure to bright light for charging is required as soon as possible.
- At Level 5, all functions are disabled and settings return to their initial factory defaults. Once the battery reaches Level 2 (M) after falling to Level 5, reconfigure the current time, date, and other settings.
- Display indicators reappear as soon as the battery is charged from Level 5 to Level 2 (M).
- Leaving the watch exposed to direct sunlight or some other very strong light source can cause the battery power indicator to show a reading temporarily that is higher than the actual battery level. The correct battery level should be indicated after a few minutes.

Power Recovery Mode

- Performing multiple sensor, illumination, or beeper operations during a short period may cause all of the battery power indicators (H, M, and L) to start flashing on the display. This indicates that the watch is in the power recovery mode. Illumination, alarm, countdown timer alarm, hourly time signal, and sensor operations will be disabled until battery power recovers.
- Battery power will recover in about 15 minutes. At this time, the battery power indicators (H, M, L) will stop flashing. This indicates that the functions listed above are enabled again.
- If all of the battery power indicators (H, M, L) are flashing and the CHG (charge) indicator also is flashing, it means the battery level is very low. Expose the watch to bright light as soon as possible.
- Even if battery power is at Level 1 (H) or Level 2 (M), the Digital Compass Mode, Barometer/Thermometer Mode, or Altimeter Mode sensor may be disabled if there is not enough voltage available to power it sufficiently. This is indicated when all of the battery power indicators (H, M, L) are flashing.
- Frequent flashing of all of the battery power indicators (H, M, L) probably means that remaining battery power is low. Leave the watch in bright light to allow it to charge.

E-12

E-13

Power Saving

When turned on, Power Saving enters a sleep state automatically whenever the watch is left for a certain period in an area where it is dark. The table below shows how watch functions are affected by Power Saving.

- For information about enabling and disabling power saving, see "To turn Power Saving on or off" (page E-93).
- There actually are two sleep state levels: "display sleep" and "function sleep".

Elapsed Time in Dark	Display	Operation
60 to 70 minutes (display sleep)	Blank, with PS flashing	Display is off, but all functions are enabled.
6 or 7 days (function sleep)	Blank, with PS not flashing	All functions are disabled, but timekeeping is maintained.

- The watch will not enter a sleep state between 6:00 AM and 9:59 PM. If the watch is already in a sleep state when 6:00 AM arrives, however, it will remain in the sleep state.
- The watch will not enter a sleep state while it is in the Stopwatch Mode or Countdown Timer Mode.

To recover from the sleep state

Move the watch to a well-lit area, press any button, or angle the watch towards your face for reading (page E-89).

E-14

E-15

Charging Times

Exposure Level (Brightness)	Daily Operation ^{*1}	Level Change ^{*2}				
		Level 5	Level 4	Level 3	Level 2	Level 1
Outdoor sunlight (50,000 lux)	5 min.	→		→	→	
Sunlight through a window (10,000 lux)	24 min.	→		→	→	
Daylight through a window on a cloudy day (5,000 lux)	48 min.	→		→	→	
Indoor fluorescent lighting (500 lux)	8 hours	→		→	→	

^{*1} Approximate amount of exposure time required each day to generate enough power for normal daily operation.

^{*2} Approximate amount of exposure time (in hours) required to take power from one level to the next.

- The above exposure times all are for reference only. Actual exposure times depend on lighting conditions.
- For details about the operating time and daily operating conditions, see the "Power Supply" section of the Specifications (page E-102).

Mode Reference Guide

The mode you should select depends on what you want to do.

To do this:	Enter this mode:	See:
<ul style="list-style-type: none"> • View the current date in the Home City • Configure Home City and daylight saving time (DST) settings • Configure time and date settings 	Timekeeping Mode	E-19
Determine your current bearing or the direction from your current location to a destination	Digital Compass Mode	E-25
<ul style="list-style-type: none"> • View the barometric pressure and temperature at your current location • View a graph of barometric pressure readings 	Barometer/Thermometer Mode	E-38
<ul style="list-style-type: none"> • View the altitude at your current location • Determine the altitude differential between two locations (reference point and current location) • Record an altitude reading with the reading time and date 	Altimeter Mode	E-48
Recall records created in the Altimeter Mode	Data Recall Mode	E-67
View the sunrise and sunset times for a specific date	Sunrise/Sunset Mode	E-74
Use the stopwatch to measure elapsed time	Stopwatch Mode	E-78
Use the countdown timer	Countdown Timer Mode	E-80
Set an alarm time	Alarm Mode	E-82
View the current time in one of 48 cities (31 time zones) around the globe	World Time Mode	E-86

Selecting a Mode

- The illustration below shows which buttons you need to press to navigate between modes.
- To return to the Timekeeping Mode from any other mode, hold down (D) for about two seconds.

- You can use buttons (A), (B), and (C) to enter a sensor mode directly from the Timekeeping Mode or from another sensor mode. To enter a sensor mode from the Sunrise/Sunset, Data Recall, Alarm, Stopwatch, Countdown Timer, or World Time, first enter the Timekeeping Mode and then press the applicable button.

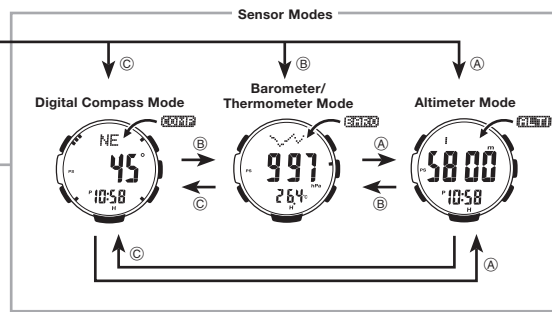
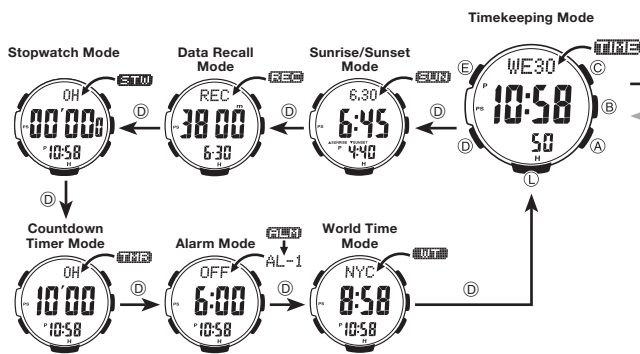

E-16

E-17

General Functions (All Modes)

The functions and operations described in this section can be used in all of the modes.

Direct Timekeeping Mode Access

- To enter the Timekeeping Mode from any other mode, hold down (D) for about two seconds.

Auto Return Features

- The watch will automatically return to the Timekeeping Mode if you do not perform any button operation for a particular amount of time in each mode.

Mode Name	Approximate Elapsed Time
Sunrise/Sunset, Data Recall, Alarm, Digital Compass	3 minutes
Altimeter	1 hour minimum 12 hours maximum
Barometer/Thermometer	1 hour
Setting screen (digital setting flashing)	3 minutes

- If you leave a screen with flashing digits on the display for two or three minutes without performing any operation, the watch exits the setting screen automatically.

Initial Screens

When you enter the Data Recall, Alarm, World Time, or Digital Compass Mode, the data you were viewing when you last exited the mode appears first.

Scrolling

The (A) and (C) buttons are used on the setting screen to scroll through data on the display. In most cases, holding down these buttons during a scroll operation scrolls through the data at high speed.

E-18

Timekeeping

Use the Timekeeping Mode (TIME) to set and view the current time and date.

- Each press of (E) in the Timekeeping Mode will change screen contents as shown below.

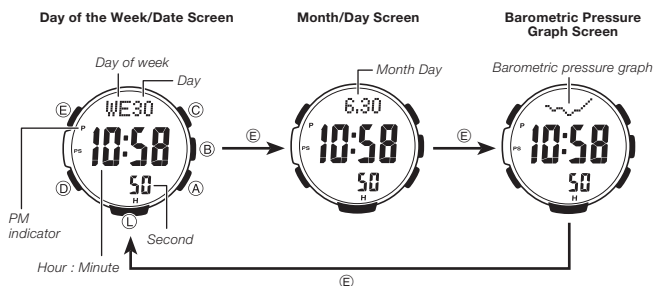

E-19

Configuring Home City Settings

There are two Home City settings: actually selecting the Home City and selecting either standard time or daylight saving time (DST).

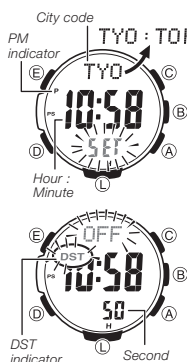

E-20

To configure Home City and summer time settings

- In the Timekeeping Mode, hold down (E) for at least two seconds. First, SET Hold will flash on the display, and CITY will be displayed in the upper display. After that, the currently selected city code and city name will scroll across the upper display. Keep (E) depressed until the scrolling starts.
 - The watch will exit the setting mode automatically if you do not perform any operation for about two or three minutes.
 - For details about city codes, see the "City Code Table" at the back of this manual.
- Use (A) (East) and (C) (West) to scroll through the available city codes.
 - Keep scrolling until the city code you want to select as your Home City is displayed.
- Press (D) to display the DST setting screen.
- Press (A) to toggle the DST setting between Daylight Saving Time (ON) and Standard Time (OFF).
 - Note that you cannot switch between standard time and daylight saving time (DST) while UTC is selected as your Home City.

- After all of the settings are the way you want, press (E) twice to exit the setting screen.
 - Daylight Saving Time is turned on when the DST indicator is on the display.

Note

- After you specify a city code, the watch will use UTC* offsets in the World Time Mode to calculate the current time for other time zones based on the current time in your Home City.
- * Coordinated Universal Time, the world-wide scientific standard of timekeeping. The reference point for UTC is Greenwich, England.

E-21

Configuring Current Time and Date Settings

You can use the procedure below to adjust the Timekeeping Mode time and date settings if they are off.

To change the current time and date settings

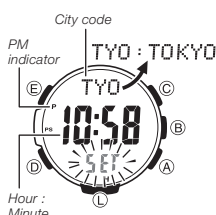

- In the Timekeeping Mode, hold down (E) for at least two seconds. First, SET Hold will flash on the display, and CITY will be displayed in the upper display. After that, the currently selected city code and city name will scroll across the upper display. Keep (E) depressed until the scrolling starts.

- Press (D) to move the flashing in the sequence shown below to select the other settings.

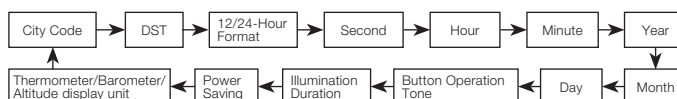

- When the timekeeping setting you want to change is flashing, use (A) and/or (C) to change it as described below.

Screen	To do this:	Do this:
TYO	Change the city code	Use (A) (East) and (C) (West).
OFF	Toggle between Daylight Saving Time (ON) and Standard Time (OFF).	Press (A).
12H	Toggle between 12-hour (12H) and 24-hour (24H) timekeeping.	Press (A).
50	Reset the second to 00 (If the current seconds count is between 30 and 59, one is added to the minute count).	Press (A).
10:58	Change the hour or minute	Use (A) (+) and (C) (-).
2021 6.30	Change the year, month, or day	

- After all of the settings are the way you want, press (E) twice to exit the setting screen.

E-22

E-23

Note

- While the 12-hour format is selected for timekeeping, a **P** (PM) indicator will appear for times from noon to 11:59 p.m. No indicator appears for times from midnight to 11:59 a.m. With 24-hour format, time is displayed from 0:00 to 23:59, without any **P** (PM) indicator.
- The watch's built-in full automatic calendar makes allowances for different month lengths and leap years. Once you set the date, there should be no reason to change it except after you have the watch's rechargeable battery replaced or after power drops to Level 5 (page E-11).
- The day of the week changes automatically when the date changes.
- Refer to the pages shown below for more information on Timekeeping Mode settings.
 - Button operation tone on/off: "To turn the button operation tone on and off" (page E-92)
 - Illumination duration setting: "To change the illumination duration" (page E-88)
 - Enabling and disabling power saving: "To turn Power Saving on or off" (page E-93)
 - Changing the temperature, barometric pressure, and altitude display units (for a city code other than **TYO**): "To specify temperature, barometric pressure, and altitude display units" (page E-36)

Taking Direction Readings

The Digital Compass Mode uses a built-in direction sensor to take direction readings and display the results. North is indicated by three graphic segments (■■■). The watch also displays literal indications of the bearing and the bearing angle to your objective.

- For information about what you can do to improve digital compass reading accuracy, see "Calibrating the Bearing Sensor" (page E-27) and "Digital Compass Precautions" (page E-34).

To take a direction reading

- Make sure the watch is in the Timekeeping Mode or any one of the sensor modes.
 - The sensor modes are: Digital Compass Mode, Barometer/Thermometer Mode, and Altimeter Mode.
- Place the watch on a flat surface. If you are wearing the watch, make sure that your wrist is horizontal (in relation to the horizon).
- Point the 12 o'clock position of the watch in the direction whose reading you want to take.
- Press **C** to start.
 - COMP** will appear in the upper display to indicate that a digital compass operation is in progress.
 - The sensor modes are: Digital Compass Mode, Barometer/Thermometer Mode, and Altimeter Mode.

E-24

E-25

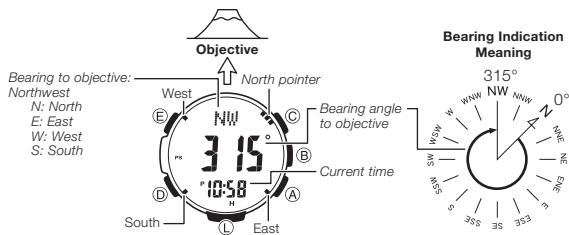

Note

- If the four pointers (north, south, east, west) and the literal direction indication do not appear on the display when you press **C**, it could mean that the watch is displaying bearing memory information. If this happens, press **E** to delete the current bearing memory contents. For more information, see "Using Bearing Memory" (page E-31).
- To return to the Timekeeping Mode, press **D**. Pressing **D** will return to the Timekeeping Mode even if a reading operation is in progress.

Digital Compass Readings

- When you press **C** to start digital compass reading operation, **COMP** will initially appear on the display to indicate that a digital compass operation is in progress.
- After the first reading is obtained, the watch will continue to take digital compass readings automatically each second for up to 60 seconds. After that, the reading operation will stop automatically. --- will be shown for the literal direction indication and the bearing angle to your objective.
- The auto light switch is disabled during the 60 seconds that digital compass readings are being taken.
- The margin of error for the bearing angle and the literal direction indication to your objective is ± 11 degrees while the watch is horizontal (in relation to the horizon). If the indicated direction is northwest (**NW**) and 315 degrees, for example, the actual direction can be anywhere from 304 to 326 degrees.
- Note that taking a direction reading while the watch is not horizontal (in relation to the horizon) can result in large direction reading error.
- You can calibrate the bearing sensor if you suspect the direction reading is incorrect.
- Any ongoing direction reading operation is paused temporarily while the watch is performing an alert operation (daily alarm, Hourly Time Signal, countdown timer alarm) or while illumination is turned on (by pressing **L**). The direction reading operation resumes for its remaining duration after the operation that caused it to pause is finished.
- See "Digital Compass Precautions" (page E-34) for important information about taking direction readings.

Calibrating the Bearing Sensor

You should calibrate the bearing sensor whenever you feel that the direction readings being produced by the watch are off. You can use any one of two different bearing sensor calibration methods: bidirectional calibration or magnetic declination correction.

E-26

E-27

Bidirectional Calibration

Bidirectional calibration calibrates the bearing sensor in relation to magnetic north. Use bidirectional calibration when you want to take readings within an area exposed to magnetic force. This type of calibration should be used if the watch becomes magnetized for any reason.

Important!

To ensure correct direction readings by this watch, be sure to perform bidirectional calibration before using it. The watch may produce incorrect direction readings if you do not perform bidirectional calibration.

Magnetic Declination Correction

With magnetic declination correction, you input a magnetic declination angle (difference between magnetic north and true north), which allows the watch to indicate true north. You can perform this procedure when the magnetic declination angle is indicated on the map you are using. Note that you can input the declination angle in whole degree units only, so you may need to round off the value specified on the map. If your map indicates the declination angle as 7.4°, you should input 7°. In the case of 7.6° input 8°, for 7.5° you can input 7° or 8°.

Precautions about bidirectional calibration

- You can use any two opposing directions for bidirectional calibration. You must, however, make sure that they are 180 degrees opposite each other. Remember that if you perform the procedure incorrectly, you will get wrong bearing sensor readings.
- Do not move the watch while calibration of either direction is in progress.
- You should perform bidirectional calibration in an environment that is the same as that where you plan to be taking direction readings. If you plan to take direction readings in an open field, for example, calibrate in an open field.

To perform bidirectional calibration

- In the Digital Compass Mode, hold down **E** for at least two seconds. First, **SET Hold** will flash on the display. After that, **CALIBRATION** will scroll across the upper display. Keep **E** depressed until **CALIBRATION** starts scrolling.
 - At this time, the north pointer flashes at the 12 o'clock position and the display will show **-1-** to indicate that the watch is ready to calibrate the first direction.
- Place the watch on a level surface facing any direction you want, and press **C** to calibrate the first direction.
 - is shown on the display while calibration is being performed. When calibration is successful, **Turn 180°** will appear on the display and three graphic segments (■■■) will flash at 6 o'clock. After about one second, **CALIBRATION -2-** will scroll across the upper display.
 - If **ERR-1** appears on the display, press **C** again to restart the direction reading operation.
- Rotate the watch 180 degrees.
- Press **C** again to calibrate the second direction.
 - is shown on the display while calibration is being performed. When calibration is successful, the display will show **OK** and then change to the Digital Compass Mode screen.

E-28

E-29

To perform magnetic declination correction

Magnetic declination angle direction value (E, W, or OFF)

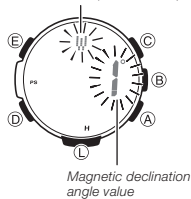

- In the Digital Compass Mode, hold down **E** for at least two seconds. First, **SET Hold** will flash on the display. After that, **CALIBRATION** will scroll across the upper display. Keep **E** depressed until **CALIBRATION** starts scrolling.
- Press **D**.
 - DEC 0°** will appear on the display and then the current magnetic declination angle setting will flash on the display.
- Use **A** (East) and **C** (West) to change the settings.
 - The following explains magnetic declination angle direction settings.
 - OFF:** No magnetic declination correction performed. The magnetic declination angle with this setting is 0°.
 - E:** When magnetic north is to the east (east declination)
 - W:** When magnetic north is to the west (west declination)
 - You can select a value within the range of W 90° to E 90° with these settings.
 - You can turn off (**OFF**) magnetic declination correction by pressing **A** and **C** at the same time.
 - The illustration, for example, shows the value you should input and the direction setting you should select when the map shows a magnetic declination of 1° West.
- When the setting is the way you want, press **E** to exit the setting screen.

Using Bearing Memory

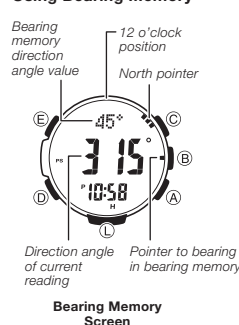

Bearing Memory lets you temporarily store and display a direction reading so you can use it as a reference as you take subsequent digital compass readings. The Bearing Memory screen displays the direction angle for the stored reading, along with a pointer that indicates the stored reading.

When you take digital compass readings while the Bearing Memory screen is displayed, the direction angle of the current digital compass reading (as read from the 12 o'clock position of the watch) and the stored Bearing Memory direction reading will both be shown.

To store a direction angle reading in Bearing Memory

- Press **C** to start a digital compass reading operation (page E-25).
 - This will take an initial reading and then take readings every second for 60 seconds.
 - If a bearing memory direction angle value is already displayed, it means that there is a reading already stored in Bearing Memory. If this happens, press **E** to clear the Bearing Memory reading and exit the bearing memory screen before performing the above step.

E-30

E-31

2. During the 60 seconds that digital compass readings are being taken, press **(E)** to store the current reading in Bearing Memory.
- The Bearing Memory direction angle flashes for about one second as it is stored in Bearing Memory. After that, the Bearing Memory screen (which shows the bearing memory direction angle and pointer) will appear, and a new 60-second direction reading operation will start.
 - You can press **(C)** at any time while the Bearing Memory screen is displayed, to start a new 60-second direction reading operation. Doing so will display the direction angle for the direction that the 12 o'clock position of the watch is pointed. The direction angle of the current reading will disappear from the display after the 60-second direction reading operation is complete.
 - During the first 60 seconds after you display the Bearing Memory screen or during a 60-second direction reading operation you triggered by pressing **(C)** while the Bearing Memory screen is on the display, the direction stored in memory is indicated by a Bearing Memory pointer.
 - Pressing **(E)** while the Bearing Memory screen is displayed will clear the reading currently in Bearing Memory and start a new 60-second direction reading operation.

Setting a map and finding your current location

Having an idea of your current location is important when mountain climbing or hiking. To do this, you need to "set the map", which means to align the map so the directions indicated on it are aligned with the actual directions of your location. Basically what you are doing is aligning north on the map with north as indicated by the watch.

- Note that map reading skills and experience are required to determine your current location and destination on a map.

Example: Advancing to an objective while monitoring the direction to it

Even if you lose sight of your objective, you can use a map to store the required bearing in bearing memory and refer to the memorized information to advance to your objective.

1. Set the map (page E-32).
2. Without changing the orientation of the map, place the watch on it at your current location, and point 12 o'clock at your desired objective on the map.
3. With the 12 o'clock position of the watch pointed towards your objective on the map, press **(C)**.
 - The watch starts taking direction readings, with the first result appearing after about one second.
4. During the approximately 60 seconds that direction readings are being taken, press **(E)** to store the bearing direction in memory.
 - To recall a stored bearing and display its literal direction indication and bearing angle, press **(C)**. Now you can advance towards your objective while observing the stored direction on the watch display.

Important!

- As you progress, the direction to your bearing will change, so you need to keep updating the information in bearing memory.

Digital Compass Precautions

Magnetic North and True North

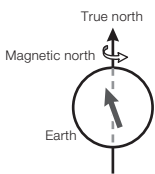

The northerly direction can be expressed either as magnetic north or true north, which are different from each other. Also, it is important to keep in mind that magnetic north moves over time.

- Magnetic north is the north that is indicated by the needle of a compass.
- True north, which is the location of the North Pole of the Earth's axis, is the north that is normally indicated on maps.
- The difference between magnetic north and true north is called the "declination". The closer you get to the North Pole, the greater the declination angle.

Location

- Taking a direction reading when you are near a source of strong magnetism can cause large errors in readings. Because of this, you should avoid taking direction readings while in the vicinity of the following types of objects: permanent magnets (magnetic necklaces, etc.), concentrations of metal (metal doors, lockers, etc.), high tension wires, aerial wires, household appliances (TVs, personal computers, washing machines, freezers, etc.)
- Accurate readings are impossible indoors, especially inside ferroconcrete structures. This is because the metal framework of such structures picks up magnetism from appliances, etc.
- Accurate direction readings are also impossible while in a train, boat, air plane, etc.

Storage

- The precision of the bearing sensor may deteriorate if the watch becomes magnetized. Because of this, you should store the watch away from magnets or any other sources of strong magnetism, including: permanent magnets (magnetic necklaces, etc.), concentrations of metal (metal doors, lockers, etc.), and household appliances (TVs, personal computers, washing machines, freezers, etc.)
- Whenever you suspect that the watch may have become magnetized, perform the procedure under "To perform bidirectional calibration" (page E-29).

Specifying Temperature, Barometric Pressure, and Altitude Display Units

Use the procedure below to specify the temperature, barometric pressure, and altitude display units to be used in the Barometer/Thermometer Mode and the Altimeter Mode.

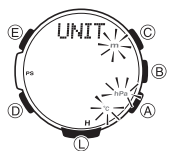

Important!

- When **TYO** (Tokyo) is selected as the Home City, the altitude unit is set automatically to meters (**m**), the barometric pressure unit to hectopascals (**hPa**), and the temperature unit to Celsius (**°C**). These settings cannot be changed.

To specify temperature, barometric pressure, and altitude display units

1. In the Timekeeping Mode, hold down **(E)** for at least two seconds. First, **SET Hold** will flash on the display, and **CITY** will be displayed in the upper display. After that, the currently selected city code and city name will scroll across the upper display. Keep **(E)** depressed until the scrolling starts.
2. Press **(D)** as many times as necessary until **UNIT** appears on the display.
 - See the sequence in step 2 of the procedure under "To change the current time and date settings" (page E-22) for information about how to scroll through setting screens.

3. Perform the operations below to specify the display units you want.

To specify this unit:	Press this key:	To toggle between these settings:
Altitude	(A)	m (meters) and ft (feet)
Barometric Pressure	(B)	hPa (hectopascals) and inHg (inches of mercury)
Temperature	(C)	°C (Celsius) and °F (Fahrenheit)

4. After all of the settings are the way you want, press **(E)** twice to exit the setting screen.

Taking Barometric Pressure and Temperature Readings

This watch uses a pressure sensor to measure air pressure (barometric pressure) and a temperature sensor to measure temperature.

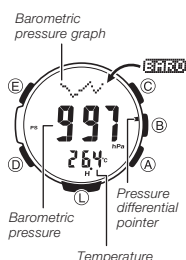

To take barometric pressure and temperature readings

While in the Timekeeping Mode or in any of the sensor modes, press **(B)** to take barometric pressure and temperature readings.

- **BARO** will appear on the display, indicating that barometric pressure and temperature reading are in progress. The results will appear on the display after about one second.
- After you press **(B)**, the watch will take readings every five seconds for the first three minutes, and then every two minutes after that.

Note

- Press **(D)** to return to the Timekeeping Mode.
- The watch will return to the Timekeeping Mode automatically if you do not perform any operation for about 1 hour after entering the Barometer/Thermometer Mode.

Barometric pressure change indicator

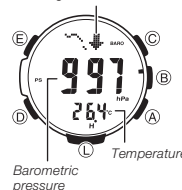

Barometric Pressure

- Barometric pressure is displayed in units of 1 hPa (or 0.05 inHg).
- The displayed barometric pressure value changes to --- if a measured barometric pressure falls outside the range of 260 hPa to 1,100 hPa (7.65 inHg to 32.45 inHg). The barometric pressure value will reappear as soon as the measured barometric pressure is within the allowable range.

Temperature

- Temperature is displayed in units of 0.1°C (or 0.2°F).
- The displayed temperature value changes to --- °C (or °F) if a measured temperature falls outside the range of -10.0°C to 60.0°C (14.0°F to 140.0°F). The temperature value will reappear as soon as the measured temperature is within the allowable range.

Display Units

You can select either hectopascals (hPa) or inchesHg (inHg) as the display unit for the measured barometric pressure, and Celsius (°C) or Fahrenheit (°F) as the display unit for the measured temperature value. See "To specify temperature, barometric pressure, and altitude display units" (page E-36).

Barometric Pressure Graph

Barometric pressure graph



Barometric pressure indicates changes in the atmosphere. By monitoring these changes you can predict the weather with reasonable accuracy. This watch takes barometric pressure reading automatically every two hours. Readings are used to produce barometric pressure graph and barometric pressure differential pointer readings.

Reading the Barometric Pressure Graph

The barometric pressure graph shows a chronological history of pressure readings.

- When display of the barometric change indicator is disabled, the graph shows the results of up to 21 barometric pressure readings (42 hours).
- When display of the barometric change indicator is enabled, the graph shows the results of up to 11 barometric pressure readings (22 hours).

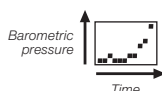

- The horizontal axis of the graph represents time, with each dot standing for two hours. The rightmost dot represents the most recent reading.
- The vertical axis of the graph represents barometric pressure, with each dot standing for the relative difference between its reading and that of the dots next to it. Each dot represents 1 hPa.

E-40

The following shows how to interpret the data that appears on the barometric pressure graph.



Rising barometric pressure indicates that upcoming weather will improve.

Falling barometric pressure indicates that upcoming weather will deteriorate.

Note

- If there are sudden changes in weather or temperature, the graph line of past reading may run off the top or bottom of the display.
- The following conditions cause the barometric pressure reading to be skipped, with the corresponding point on the barometric pressure graph being left blank.
 - Barometric reading that is out of range (260 hPa to 1,100 hPa or 7.65 inHg to 32.45 inHg)
 - Sensor malfunction



Not visible on the display.

Barometric Pressure Differential Pointer



Barometric pressure differential pointer

This pointer indicates the relative difference between the most recent barometric pressure reading indicated on the barometric pressure graph (page E-40), and the current barometric pressure value displayed in the Barometer/Thermometer Mode (page E-39).

Reading Barometric Pressure Differential Pointer

Pressure differential is indicated in the range of ± 10 hPa, in 1-hPa units.

- The nearby screen shot, for example, shows what the pointer would indicate when the calculated pressure differential is approximately -5 hPa (approximately -0.15 inHg).
- Barometric pressure is calculated and displayed using hPa as the standard. The barometric pressure differential also can be read in inHg units as shown in the illustration (1 hPa \approx 0.03 inHg).

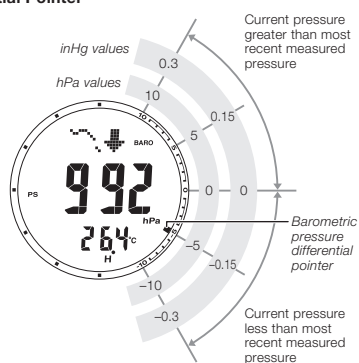

E-42

Barometric Pressure Change Indications

Your watch analyzes past barometric pressure readings and uses a barometric pressure change indicator to inform you about changes in pressure. If it determines there has been a significant change in pressure, it will beep and all of the graphic segments (■) around the periphery of the face will flash as a barometric pressure change alert. This means you could start taking barometric pressure readings after reaching a lodge or camp area, and then check the watch the next morning for changes in pressure, and plan your day's activities accordingly. Note that you can enable or disable display of the barometric pressure change indicator as desired.

Reading the Barometric Pressure Change Indicator

Indicator	Meaning
BARO	Sudden fall in pressure.
BARO	Sudden rise in pressure.
BARO	Sustained rise in pressure, changing to a fall.
BARO	Sustained fall in pressure, changing to a rise.

- The barometric pressure change indicator is not displayed if there has been no noteworthy change in barometric pressure.

Important!

- To ensure proper results, take barometric readings under conditions where the altitude remains constant.

Example

- In a lodge or campground
- On the ocean

- A change in altitude causes a change in barometric pressure. Because of this, correct readings are impossible. Do not take readings while ascending or descending a mountain, etc.

Enabling or Disabling Display of the Barometric Pressure Change Indicator

You can enable or disable display of the barometric pressure change indicator as desired. When display of the indicator is enabled, the watch will take a barometric pressure reading every two minutes, regardless of the mode it is in.

- When **BARO** is shown on the display, it means that barometric pressure change indicator display is enabled.
- When **BARO** is not on the display, it means that barometric pressure change indicator display is disabled.

To enable or disable the barometric pressure change alert

In the Barometer/Thermometer Mode, hold down (E) for at least two seconds. Keep (E) depressed until the current setting (**INFO Hold ON** or **INFO Hold OFF**) starts to flash on the display.

- If barometric pressure change indicator display is currently enabled, **BARO** will also appear in the upper display. **BARO** will not appear if display is currently disabled.
- Note that barometric pressure change indicator display will turn off automatically 24 hours after you turn it on or battery power goes low.

E-44

To calibrate the pressure sensor and the temperature sensor

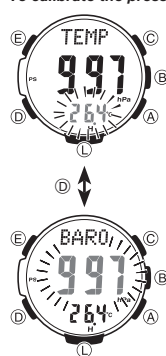

1. Take a reading with another measurement device to determine the exact current barometric pressure or temperature.
2. With the watch in the Timekeeping Mode or in any of the sensor modes, press (B) to enter the Barometer/Thermometer Mode.
3. Hold down (E) for at least two seconds. **SET Hold** will flash on the display and then **TEMP** will appear in the upper display. Keep (E) depressed until **TEMP** appears.
 - The current temperature calibration setting will flash in the lower display at this time.
4. Press (D) to move the flashing between the temperature value and barometric pressure value, to select the one you want to calibrate.
5. Use (A) (+) and (C) (-) to select the temperature and barometric pressure value display units as shown below.

Temperature	0.1°C (0.2°F)
Barometric Pressure	1 hPa (0.05 inHg)

 - To return the currently flashing value to its initial factory default setting, press (A) and (C) at the same time. **OFF** will appear at the flashing location for about one second, followed by the initial default value.
6. Press (E) to return to the Barometer/Thermometer Mode screen.

E-46

- Note that power saving (page E-14) are disabled while barometric pressure change indicator display is enabled.
- Note that barometric pressure change indicator display cannot be enabled while the watch's battery is low.

Pressure Sensor and Temperature Sensor Calibration

The pressure sensor and temperature sensor built into the watch are calibrated at the factory and normally require no further adjustment. If you notice serious errors in the pressure readings and temperature readings produced by the watch, you can calibrate the sensor to correct the errors.

Important!

- Incorrectly calibrating the barometric pressure sensor can result in incorrect readings. Before performing the calibration procedure, compare the readings produced by the watch with those of another reliable and accurate barometer.
- Incorrectly calibrating the temperature sensor can result in incorrect readings. Carefully read the following before doing anything.
 - Compare the readings produced by the watch with those of another reliable and accurate thermometer.
 - If adjustment is required, remove the watch from your wrist and wait for 20 or 30 minutes to give the temperature of the watch time to stabilize.

Barometer and Thermometer Precautions

- The pressure sensor built into this watch measures changes in air pressure, which you can then apply to your own weather predictions. It is not intended for use as a precision instrument in official weather prediction or reporting applications.
- Sudden temperature changes can affect pressure sensor readings. Because of this, there may be some error in the readings produced by the watch.
- Temperature reading are affected by your body temperature, direct sunlight, and moisture. To achieve a more accurate temperature reading, remove the watch from your wrist, place it in a well ventilated location out of direct sunlight, and wipe all moisture from the case. It takes approximately 20 to 30 minutes for the case of the watch to reach the surrounding temperature.

E-41

E-43

E-45

E-47

Using the Altimeter Mode

The watch takes altitude readings and displays results based on air pressure measurements taken by a built-in pressure sensor.

- The displayed altitude reading is a relative altitude that is calculated based on measurement of changes in barometric pressure by the watch's pressure sensor. This means that barometric pressure changes can cause readings taken at different times at the same location to be different. Also note that the value displayed by the watch may be different from the actual elevation and/or sea level elevation indicated for the area where you are located.
- When using the altimeter of this watch for mountain climbing or other activities, it is highly recommended that you check a map, local altitude indications, or some other source for your current correct altitude and regularly calibrate the altimeter with the latest information.

Important!

- See "To specify a reference altitude value" (page E-55) and "Altimeter Precautions" (page E-66) for information about how to minimize differences between readings produced by the watch and values provided by local altitude (elevation) indications.

Getting Ready

Before actually taking an altitude reading you need to select an altitude screen format and select an altitude reading interval.

E-48

Selecting the Altitude Screen Format

You can select either of two screen formats for the Altimeter Mode.

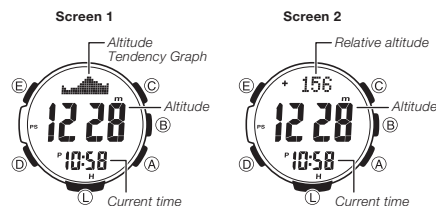

- Altitude tendency graph contents are updated each time you take an altitude reading.
- Graph units are 10 meters on the vertical axis, and the measurement reading interval (one second, five seconds, or two minutes) on the horizontal axis (page E-51).
- To take readings of the difference between the altitude at your current location and the altitude at a reference point, select Screen 2. See "Using an Altitude Differential Value" (page E-56) for more information.

To select the altitude screen format

- In the Altimeter Mode, hold down (E) for at least two seconds.
 - SET Hold** will flash on the display and then **ALTI** will appear in the upper display. Keep (E) depressed until **ALTI** appears.
 - The current altitude value will appear at this time.
- Press (D) twice.
 - DISP** will appear, and then the current screen setting will appear in the upper display.
- Use (A) to toggle the setting between the two screens.

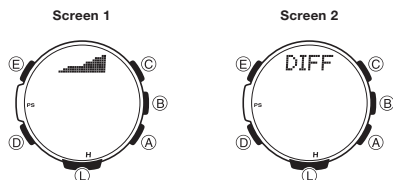

- Press (E) to exit the setting screen.

E-50

Selecting the Altitude Auto Reading Interval

You can select either of the following two altitude auto reading intervals.

- 0'05**: Readings at one-second intervals for the first three minutes, and then every five seconds for approximately the next hour
- 2'00**: Readings at one-second intervals for the first three minutes, and then every two minutes for approximately the next 12 hours

Note

- If you do not perform any button operation while in the Altimeter Mode, the watch will return to the Timekeeping Mode automatically after 12 hours (altitude auto reading interval: **2'00**) or after one hour (altitude auto reading interval: **0'05**).
- If trek log operation is in progress with **0'05** selected as the altitude auto measurement method, exiting the Altimeter Mode to another mode will automatically cause the auto reading interval to change to **2'00**.

To select the altitude auto reading interval

- In the Altimeter Mode, hold down (E) for at least two seconds. **SET Hold** will flash on the display and then **ALTI** will appear in the upper display. Keep (E) depressed until **ALTI** appears.
 - The current altitude reading value will appear at this time.
- Press (D) to display the current altitude auto reading interval setting.
 - This will cause **INTERVAL** to scroll across the top display. The current altitude auto reading interval setting (**0'05** or **2'00**) will be flashing in the center display.



- Press (A) to toggle the altitude auto measurement interval setting between **0'05** and **2'00**.
- Press (E) to exit the setting screen.

Taking Altitude Readings

Use the procedure below to take basic altitude readings.

- See "Using Reference Altitude Values" (page E-54) for information about how to make altimeter readings more accurate.
- See "How does the altimeter work?" (page E-65) for information about how the watch measures altitude.

E-52

To take altitude readings

Screen 1 Selected
Altitude Tendency Graph

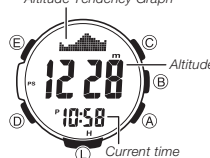

Screen 2 Selected
Relative altitude



- Make sure the watch is in the Timekeeping Mode or any one of the sensor modes.
 - The sensor modes are: Digital Compass Mode, Barometer/Thermometer Mode, and Altimeter Mode.
- Press (A) to start auto altimeter readings.
 - The current altitude value is displayed in units of 1 meter (5 feet).
 - For information about the measurement interval, see page E-51.

Note

- After you are finished, press (D) to return to the Timekeeping Mode and stop auto altimeter readings.
- The watch will return to the Timekeeping Mode automatically if you do not perform any operation (page E-18).
- The measurement range for altitude is -700 to 10,000 meters (-2,300 to 32,800 feet).
- The displayed altitude value changes to --- if an altitude reading falls outside the measurement range. An altitude value will reappear as soon as the altitude reading is within the allowable range.
- Normally, displayed altitude values are based on the watch's preset conversion values. You also can specify a reference altitude value, if you want. See "Using Reference Altitude Values" (page E-54).

- You can change the unit for displayed altitude values to either meters (m) or feet (ft). See "To specify temperature, barometric pressure, and altitude display units" (page E-36).

Using Reference Altitude Values

To minimize the chance of reading error, you should update the reference altitude value before setting off on a trek or any other activity where you plan to take altitude readings. While mountain climbing, it is highly recommended that you check a map, local altitude indications, or some other source for your current correct altitude and regularly update the reference altitude value with the latest information.

- Reading error can be caused by changes in barometric pressure, and by temperature changes due to change in barometric pressure and/or elevation.
- Though altitude readings can be taken without setting a reference altitude, doing so may produce readings that are very different from altitudes indicated by other altitude markers and indications.
- Before performing the procedure below, look up the altitude of your current location on a map, the Internet, etc.

E-54

To specify a reference altitude value



- In the Altimeter Mode, hold down (E) for at least two seconds. **SET Hold** will flash on the display and then **ALTI** will appear in the upper display. Keep (E) depressed until **ALTI** appears.
 - The current altitude reading value will appear at this time.
- Use (A) (+) or (C) (-) to change the current reference altitude value in 1-meter (5-foot) increments.
 - Change the reference altitude value to an accurate altitude reading that you get from a map or other source.
 - You can set the reference altitude value within the range of -10,000 to 10,000 meters (-32,800 to 32,800 feet).
 - Pressing (A) and (C) at the same time returns to **OFF** (no reference altitude value), so the watch performs air pressure to altitude conversions based on preset data only.
- Press (E) to exit the setting screen.

E-49

E-51

E-53

E-55

Advanced Altimeter Mode Operations

Use the information in this section to obtain more accurate altimeter readings, especially while mountain climbing or trekking.

Using an Altitude Differential Value



The Altimeter Mode screen has an altitude differential value that shows the change in altitude from a reference point you specify. The altitude differential value is updated each time the watch takes an altitude reading.

- The range of the altitude differential value is -3,000 meters (-9,995 feet) to 3,000 meters (9,995 feet).
- ----- is displayed in place of the altitude differential value whenever the measured value is outside the allowable range.
- See "Using the Altitude Differential Value While Mountain Climbing or Hiking" (page E-58) for some real-life examples of how to use this feature.

E-56

To specify the altitude differential start point



1. In the Altimeter Mode, select Screen 2 as the Altimeter Mode display (page E-50).
2. Press (E).
 - The watch will take an altitude reading and register the result as the altitude differential value start point. The altitude differential value will be reset to zero at this time.

Using the Altitude Differential Value While Mountain Climbing or Hiking

After you specify the altitude differential start point while mountain climbing or hiking, you can easily measure the change in the altitude between that point and other points along the way.

To use the altitude differential value

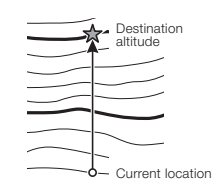

1. In the Altimeter Mode, check to make sure that an altitude reading is on the display.
 - If an altitude reading is not displayed, press (A) to take one. See "To take altitude readings" (page E-53) for details.
2. Use the contour lines on your map to determine the difference in altitude between your current location and your destination.
3. In the Altimeter Mode, press (E) to specify your current location as the altitude differential start point.
 - The watch will take an altitude reading and register the result as the altitude differential value start point. The altitude differential value will be reset to zero at this time.
4. While comparing the altitude difference you determined on the map and the watch's altitude differential value, advance towards your destination.
 - If the map shows that the difference in altitude between your location and your destination is +80 meters for example, you know you will be nearing your destination when the displayed altitude differential value shows +80 meters.

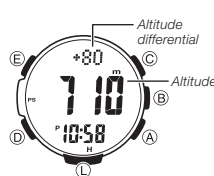

E-58

Types of Altitude Data

Your watch can record three types of altitude data in its memory: manually saved data, auto save values, and trek log values.

- Use the Data Recall Mode to view data stored in memory. See "Viewing Altitude Records" (page E-67) for details.

Manually Saved Records

Any time you perform the procedure below in the Altimeter Mode, the watch will create and store a record with the currently displayed altitude reading, along with the date and time the reading was taken. There is enough memory to store up to 30 manually saved records, which are numbered from **REC01** through **REC30**.

To save a reading manually

1. In the Altimeter Mode, check to make sure that an altitude reading is on the display.
 - If an altitude reading is not displayed, press (A) to take one. See "To take altitude readings" (page E-53) for details.
2. Hold down (A). First, **REC Hold** will flash on the display. After that, **REC** and the current time will appear in the lower display. Release (A) as soon as **REC** and the current time appear.
 - This will save the currently displayed altitude reading in a manually saved record, along with the time and date of the reading.
 - The watch will return to the Altimeter Mode screen automatically after the save operation is complete.
 - Holding down (A) for too long will advance to trek log update start/stop (page E-62).



E-57

- There is enough memory to store up to 30 manually saved records. If there are already 30 manually saved records in memory, the above operation will cause the oldest record to be deleted automatically to make room for the new one.

Auto Save Values

Auto save values are one type of data stored in the memory of your watch.

Auto Save Values
High Altitude (MAX)
Low Altitude (MIN)
Total Ascent (ASC)
Total Descent (DSC)

- These values are checked and updated automatically by the watch as altitude auto measurements are taken.
- Auto save is performed only while the watch is in the Altimeter Mode.
- Cumulative ascent and cumulative descent values are updated whenever there is a difference of at least ±15 meters (±49 feet) from one reading to the next.
- Auto save values also include the date and time each value was recorded.

E-60

Trek Log Values

While trek log updating is enabled, altitude values (high altitude/low altitude, cumulative ascent/descent) for a particular trek are automatically checked and updated at regular intervals, even if you exit the Altimeter Mode. Values include the date and time each is updated. Up to 14 records of trek log values can be maintained in memory, and each record is assigned a number from Mt.1 through Mt.14 in the sequence they are stored.

Trek Log Values in Each Record
High Altitude (MAX)
Low Altitude (MIN)
Total Ascent (ASC)
Total Descent (DSC)

- For up to 12 hours after trek log value updating is enabled, the values are updated automatically even if you exit the Altimeter Mode. A segment (■) in the graphic around the periphery of the display flashes to show the time elapsed since trek log value updating was enabled. Each graphic segment represents 12 minutes, and one revolution around the display represents 12 hours.
- You can select the altitude reading interval you want. For more information, see "To select the altitude auto reading interval" (page E-51).
- Trek log value updating stops automatically whenever the battery charge goes low.

Note

- Even if you exit the Altimeter Mode while trekking, updating of the trek log high altitude, low altitude, and cumulative ascent and descent values continues.
- Your watch has enough memory for 14 trek log records, which means you can maintain values for up to 14 treks.

E-61

To start trek log value updating

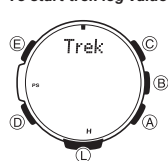

In the Altimeter Mode, hold down (A) for at least five seconds. First, **Trek Hold** will flash on the display. After that, **Hold** will disappear and a pointer (■) indicating elapsed reading time will appear at 12 o'clock. Release (A) when **Hold** disappears.

- This starts updating of trek log values (high altitude/low altitude, cumulative ascent/descent).

To stop trek log value updating

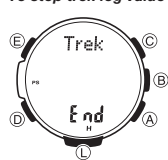

In the Altimeter Mode, hold down (A) for at least five seconds. First, **Trek Hold End** and the elapsed time pointer (■) will flash. After that, **Hold** will disappear. Release (A) when **Hold** disappears.

- This stops updating of trek log values (high altitude/low altitude, cumulative ascent/descent).

Note

- To start a new trek log record while there are already 14 trek log records in memory, you will need to delete existing records. For more information, see "To delete data in a specific memory area" (page E-72).

E-62

How High and Low Altitude Values are Updated

With each auto save or trek log reading, the watch compares the current reading against the **MAX** (high altitude) and **MIN** (low altitude) values. It will replace the **MAX** value if the current reading is at least 15 meters (±49 feet) greater than **MAX**, or the **MIN** value if the current reading is at least 15 meters (±49 feet) less than **MIN**.

How Cumulative Ascent and Cumulative Descent Values are Updated

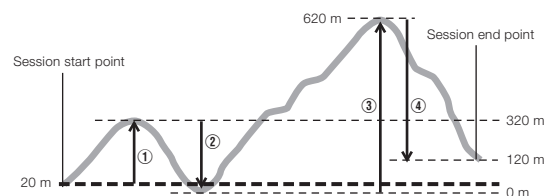

The total ascent and total descent values produced by an Altimeter Mode reading operation session during the example climb illustrated above are calculated as follows.

Total Ascent: ① (300 m) + ③ (620 m) = 920 m
 Total Descent: ② (320 m) + ④ (500 m) = 820 m

E-63

- Entering the Altimeter Mode starts a new altitude auto reading session, but it does not reset the current **ASC** and **DSC** values or change them in any way. This means that the starting **ASC** and **DSC** values for a new Altimeter Mode auto reading session are the values that currently are in memory. Each time you complete an altitude auto reading session by exiting the Altimeter Mode, the total ascent value of the current session (920 meters in the above example) is added to the session's starting **ASC** value. Also, the total descent value of the current auto reading session (-820 meters in the above example) is added to the session's starting **DSC** value.
- Logging of trek log data continues even if you exit the Altimeter Mode.

Note

- The high altitude, low altitude, total ascent, and total descent values are retained in memory when you exit the Altimeter Mode. To clear values, perform the procedure under "To delete data in a specific memory area" (page E-72).

How does the altimeter work?

Generally, air pressure decreases as altitude increases. This watch bases its altitude reading on International Standard Atmosphere (ISA) values stipulated by the International Civil Aviation Organization (ICAO). These values define relationships between altitude and air pressure.

- Note that the following conditions will prevent you from obtaining accurate readings:

*When air pressure changes because of changes in the weather
Extreme temperature changes
When the watch itself is subjected to strong impact*

There are two standard methods of expressing altitude: absolute altitude, which expresses an absolute height above sea level, and relative altitude, which expresses the difference between the altitudes of two different places. This watch expresses altitudes as relative altitude.

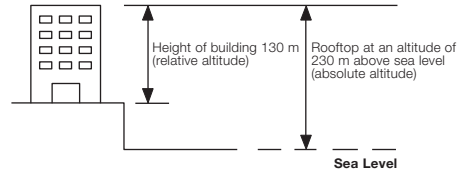

Regular calibration of the watch in accordance with values provided by local altitude (elevation) indications is recommended before taking readings in order to maximize reading accuracy (page E-54).

Altimeter Precautions

- This watch estimates altitude based on air pressure. This means that altitude readings for the same location may vary if air pressure changes.
- Do not rely upon this watch for altitude reading or perform button operations while sky diving, hang gliding, or paragliding, while riding a gyrocopter, glider, or any other aircraft, or while engaging in any other activity where there is the chance of sudden altitude changes.
- Do not use this watch for measuring altitude in applications that demand professional or industrial level precision.
- Remember that the air inside of a commercial aircraft is pressurized. Because of this, the readings produced by this watch will not match the altitude readings announced or indicated by the flight crew.

The Effect of Temperature on Altitude Readings

For the more accurate altitude readings, leaving the watch on your wrist is recommended in order to maintain the watch at a constant temperature.

- When taking altitude readings, keep the watch at as stable a temperature as possible. Changes in temperature can affect altitude readings.

Viewing Altitude Records

You can use the Data Recall Mode to view manually saved record data, auto save values, and trek log values.

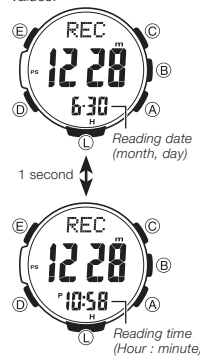

To view altitude records

1. Use (D) to select the Data Recall Mode (**REC**) as shown on page E-16.
 - About one second after **REC** appears on the display, the display will change to show the first record of the memory area you were viewing when you last exited the Data Recall Mode.
2. Use (B) to select the memory area you want.
 - After you select the Trek Log Value Area screen, use the (B) button to select the trek whose values you want to view. Treks are numbered from 1 (**Mt.1**) through 14 (**Mt.14**).
 - After you select the Manually Saved Record Area screen, the date (month and day) and time of the record will alternate on the display in the lower display at one-second intervals.

3. Use (A) and (C) to scroll through the screens for an area and display the one you want.

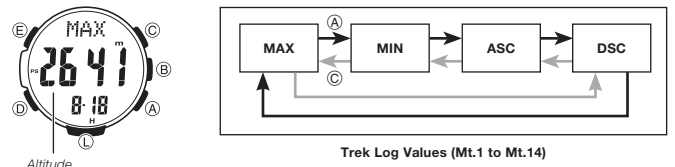
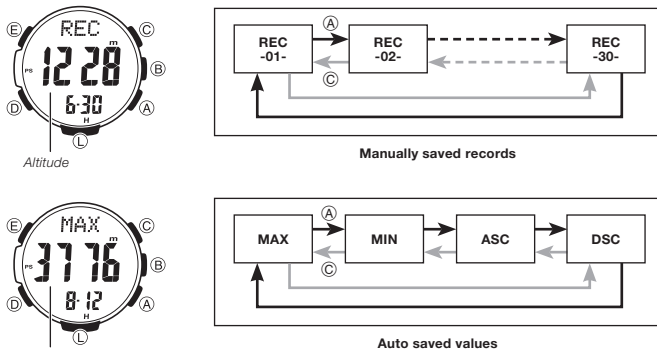

- Manually saved records (**REC01** to **REC30**), auto save **MAX** and **MIN** values, and trek log values all include the date (month and day) and time (hour and minute) that the data was recorded.
- Records of the **ASC** and **DSC** include altitude values along with the date (month, day) and year that the data was recorded.
- For details about auto save values, see "Auto Save Values" (page E-60). For details about trek log values, see "Trek Log Values" (page E-61).
- --- will be displayed if **MAX**/**MIN** data has been deleted or if there is no corresponding **MAX**/**MIN** data due to error, etc. In such cases, total ascent (**ASC**) and total descent (**DSC**) values will show zero.

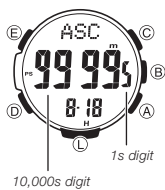

- When the total ascent (**ASC**) or total descent (**DSC**) exceeds 99,999 meters (or 327,997 feet), the applicable value will restart from zero. Note that the watch can display up to five digits only. When using feet as the altitude display units, altitude values are displayed only up to the rightmost five digits.
- When the total ascent (**ASC**) or total descent (**DSC**) value becomes five digits long, the rightmost (ones) digit is shown in the lower right of the display. The nearby illustration shows the display when the value of **ASC** is 99,995 meters.

Trek Log Values (Mt.1 to Mt.14)

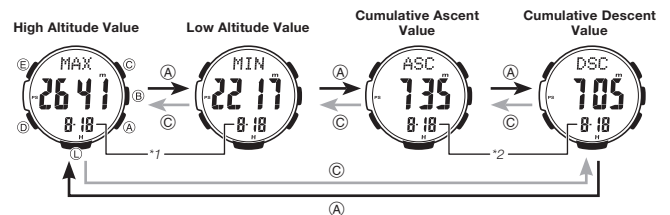

- * 1: Month and day the displayed value was recorded.
- * 2: Month and day cumulation started.
- Holding down (A) or (C) scrolls at high speed.
- On the high altitude value (**MAX**) and low altitude value (**MIN**) screens, the lower display area alternates between the date (month and day) and time at one-second intervals.
- On the cumulative ascent and cumulative descent screens, the lower display area alternates between the month and day, and the year at one-second intervals.

To delete all manually saved data

Memory contents cannot be deleted while trek log values are being recorded.

- Use **(D)** to enter the Data Recall Mode.
- Use **(B)** to display the Manually Saved Record Area (page E-67).
- Hold down **(E)** for at least three seconds. First, **Clear Hold ALL** will flash in the display. After that, **Hold** will disappear. Release **(E)** when **Hold** disappears.
 - This will cause **----** to appear in the lower display.
 - This indicates that all manually saved data is cleared.

To delete data in a specific memory area

Memory contents cannot be deleted while trek log values are being recorded.

- Use **(D)** to enter the Data Recall Mode.
- Use **(B)** to display the memory area (Manually Saved Record Area, Auto Save Value Area, or Trek Log Value Area) that contains the data you want to delete.
- What you should do next depends on which memory area you displayed in step 2, above.
 - If you displayed the Manually Saved Record Area, use **(A)** and **(C)** to display the number of the record **REC01** through **REC30** you want to delete.
 - If you displayed the Auto Save Value Area, all of its values will be deleted, so you do not need to select anything.
 - If you displayed the Trek Log Value Area, use **(B)** to display the trek (mountain) number of the record (**Mt.1** through **Mt.14**) you want to delete.

Important!

- A delete operation cannot be undone! Make sure you do not need data before you delete it.

E-72

- Hold down **(E)** for at least two seconds. First, **Clear Hold** will flash in the display. After that, **Hold** will disappear. Release **(E)** when **Hold** disappears.
 - If you are deleting a Manually Saved Record Area record, holding down **(E)** too long (after **Hold** disappears) will cause all manually saved records to be deleted.
 - Deleting a record in either the Manually Saved Record Area or Trek Log Value Area will cause all records following it to be shifted upwards and renumbered accordingly. If the record you delete is the last one currently in the memory area where you deleted it, **----** will be displayed in the display in place of the record number.
 - After you delete Auto Save Values, the **MAX** (high altitude) and **MIN** (low altitude) values will show **----**, while the **ASC** (cumulative ascent) and **DSC** (cumulative descent) values will show zero.

E-73

Looking up Sunrise and Sunset Times

You can use the Sunrise/Sunset Mode to look up the sunrise and sunset times for a particular date (year, month, day) and location.

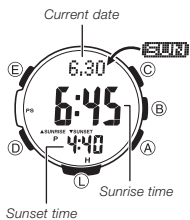

To enter the Sunrise/Sunset Mode

While in the Timekeeping Mode, press **(D)** to enter the Sunrise/Sunset Mode.

- This will display the sunrise and sunset times for the current date based the currently specified city code, latitude, and longitude.
- Sunrise/sunset times will not be displayed when battery power is low.
- Before trying to use the Sunrise/Sunset Mode, you need to configure settings for the city code, longitude, and latitude for the location whose sunrise and sunset times you want to view.
- The factory default configuration of the location is: City Code: **TYO** (Tokyo); Latitude: North 35.7 degrees; Longitude: East 139.7 degrees.

E-74

To view the sunrise/sunset time for a particular date

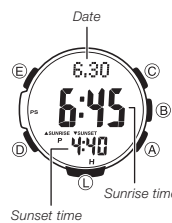

- Enter the Sunrise/Sunset Mode.
 - This will display the sunrise and sunset times for the current date at the location specified by the city code, latitude, and longitude.
- While the sunrise/sunset time are on the display, use **(A)** (+) and **(C)** (-) to scroll through the dates.
 - Pressing one of the above buttons causes the month and day to appear in the upper display area, and the year to appear in the lower display area.
 - When you release the button, the sunrise time of the selected day will be shown in the middle display, while the sunset time will be shown in the lower display.
 - You can select any date between January 1, 2000 and December 31, 2099.

Note

- If you think that the sunrise and/or sunset times are not correct for some reason, check the watch's city code, longitude and latitude settings.
- The sunrise and sunset times displayed by this watch are times at sea level. Sunrise and sunset times are also affected by elevation above sea level and geographic contours.

E-75

To look up the sunrise and sunset times for a specific location

Important!

- You do not need to perform this procedure to look up the sunrise and sunset times in your currently selected Home City.
 - If you select a different city code to look up the sunrise and sunset times there, return to the city code of your Home City (your current location) when you are finished. Otherwise, the time shown in the Timekeeping Mode will not be correct.
 - For information about the Home City setting, see "Configuring Home City Settings" (page E-20).
- In the Timekeeping Mode, hold down **(E)** for at least two seconds. First, **SET Hold** will flash on the display, and **CITY** will be displayed in the upper display. After that, the currently selected city code and city name will scroll across the upper display. Keep **(E)** depressed until the scrolling starts.
 - Use **(A)** (East) and **(C)** (West) to select the city code whose sunrise and sunset times you want to view.
 - For details about city codes, see the "City Code Table" at the back of this manual.
 - If this display shows the information you need, you can exit this procedure at this point by pressing **(E)** twice. If you want to specify a latitude and longitude for a more exact reading, advance to step 3, below.

E-76

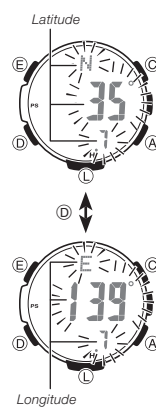

- Press **(E)** to display the longitude/latitude setting screen, with the latitude setting flashing.
- Use **(D)** to move the flashing between the latitude and the longitude setting.
- Use **(A)** (+) and **(C)** (-) to change the flashing setting.
 - You can configure the longitude and latitude setting within following ranges.
 - Latitude Range: 65.0°S (South 65.0 degrees) to 0°N to 65.0°N (North 65.0 degrees)
 - Longitude Range: 179.9°W (West 179.9 degrees) to 0°E to 180.0°E (East 180.0 degrees)
 - Latitude and longitude values are rounded off to the nearest degree.
- Press **(E)** to return to the Timekeeping Mode.
- In the Timekeeping Mode, press **(D)**.
 - Display the location whose sunrise and sunset times you want to view.

E-77

Using the Stopwatch

The stopwatch measures elapsed time, split times, and two finishes.

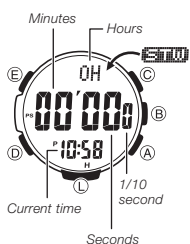

To enter the Stopwatch Mode

Use **(D)** to select the Stopwatch Mode (**STW**) as shown on page E-16.

To perform an elapsed time operation

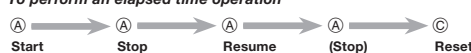

To pause at a split time



E-78

To measure two finishes

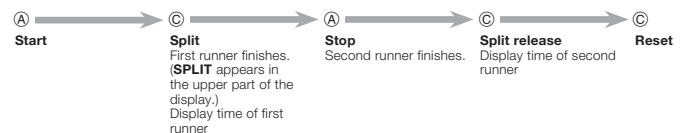

Note

- The Stopwatch Mode can indicate elapsed time up to 999 hours, 59 minutes, 59.9 seconds.
- Once started, stopwatch timing continues until you press **(A)** to stop it, even if you exit the Stopwatch Mode to another mode and even if timing reaches the stopwatch limit defined above. A paused timing operation will remain paused until you press **(A)** to restart it or **(C)** to reset.
- Exiting the Stopwatch Mode while a split time is frozen on the display clears the split time and returns to elapsed time measurement.

E-79

Using the Countdown Timer

The countdown timer can be configured to start at a preset time, and sound an alarm when the end of the countdown is reached.

Countdown time
(Hour, minutes, seconds)

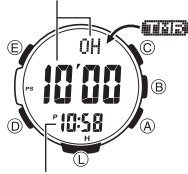

Current time

To enter the Countdown Timer Mode

Use (D) to select the Countdown Timer Mode (TMR) as shown on page E-16.

- About one second after TMR appears on the display, the display will change to show the countdown time hours.

To specify the countdown start time

1. Enter the Countdown Timer Mode.
 - If a countdown is in progress (indicated by the seconds counting down), press (A) to stop it and then press (C) to reset to the current countdown start time.
 - If a countdown is paused, press (C) to reset to the current countdown start time.
2. Hold down (E) for at least two seconds.
 - SET Hold will flash on the display and then the current start time setting will start to flash. Keep (E) depressed until the start time setting starts to flash.

3. Press (D) to move the flashing between the hour and minute settings.

4. Use (A) (+) and (C) (-) to change the flashing item.

- To set the starting value of the countdown time to 24 hours, set 0H 00'00.

E-80

5. Press (E) to exit the setting screen.

To perform a countdown timer operation

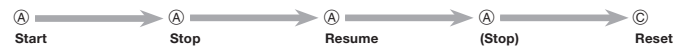

- Before starting a countdown timer operation, check to make sure that a countdown operation is not in progress (indicated by the seconds counting down). If it is, press (A) to stop it and then (C) to reset to the countdown start time.
- An alarm sounds for ten seconds when the end of the countdown is reached. This alarm will sound in all modes. The countdown time is reset to its starting value automatically when the alarm sounds.

To stop the alarm

Press any button.

E-81

Using the Alarm

Alarm name
(AL- or SIG)

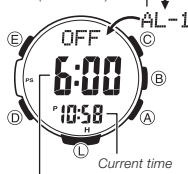

Alarm time
(Hour : Minute)

You can set five independent daily alarms. When an alarm is turned on, an alarm will sound for about 10 seconds each day when the time in the Timekeeping Mode reaches the preset alarm time. This is true even if the watch is not in the Timekeeping Mode. One of the daily alarms is a snooze alarm. The snooze alarm will sound every five minutes up to seven times or until it is turned off. You can also turn on an Hourly Time Signal, which will cause the watch to beep twice every hour on the hour.

To enter the Alarm Mode

Use (D) to select the Alarm Mode (ALM) as shown on page E-16.

- About one second after ALM appears on the display, the display will change to show an alarm name (AL-1 to AL-4, or SNZ) or the SIG indicator. The alarm name indicates an alarm screen. SIG is shown when the Hourly Time Signal screen is on the display.
- When you enter the Alarm Mode, the data you were viewing when you last exited the mode appears first.

To set an alarm time

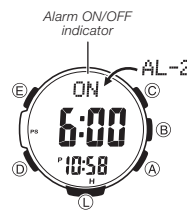

1. In the Alarm Mode, use (A) and (C) to scroll through the alarm screens until the one whose time you want to set is displayed.

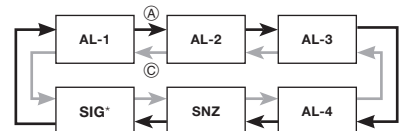

* There is no time setting for the hourly time signal.

2. Hold down (E) until SET Hold appears on the display and then the current settings start to flash.
 - This is the setting screen.
3. Press (D) to move the flashing between the hour and minute settings.
4. While a setting is flashing, use (A) (+) and (C) (-) to change it.
 - When setting the alarm time using the 12-hour format, take care to set the time correctly as a.m. (no indicator) or p.m. (P indicator).
5. Press (E) to exit the setting screen.
 - Setting an alarm time causes that alarm to turn on automatically.

E-82

E-83

To turn an alarm and the Hourly Time Signal on and off

1. In the Alarm Mode, use (A) and (C) to select an alarm or the Hourly Time Signal.

2. When the alarm or the Hourly Time Signal you want is selected, press (B) to turn it on and off.

- The alarm on indicator (when any alarm is on), snooze alarm indicator (when the snooze alarm is on), and the Hourly Time Signal on indicator (when the Hourly Time Signal is on) are shown on the display in all modes.

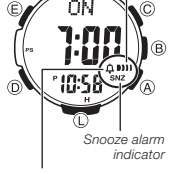

Hourly time signal
on indicator

To stop the alarm

Press any button.

Note

- The snooze alarm sounds up to seven times at intervals of about five minutes.
- After the snooze alarm first sounds, SNZ will flash on the display until the snooze alarm sounds all seven times or until it is canceled.
- The snooze alarm will be canceled when any of the following occurs while the SNZ indicator is flashing on the display.
 - If you turn off the snooze alarm
 - If you display the snooze alarm setting screen
 - If you display the Timekeeping Mode setting screen
 - If your Home City and World Time City are the same city, and you use the World Time Mode to change the summer time setting of your Home City

E-84

E-85

Checking the Current Time in a Different Time Zone

You can use the World Time Mode to view the current time in one of 31 time zones (48 cities) around the globe. The city that is currently selected in the World Time Mode is called the "World Time City".

Currently selected
World Time City



Current timekeeping
Mode time

Current time in the currently
selected World Time City

To enter the World Time Mode

Use (D) to select the World Time Mode (WT) as shown on page E-16.

- One second after WT appears on the display, the city code of the currently selected World Time City will scroll once in the upper display. After that, the World Time City's city code will be displayed in the upper display.

To view the time in another time zone

In the World Time Mode, use (A) (East) and (C) (West) to scroll through city codes.

To specify standard time or daylight saving time (DST) for a city

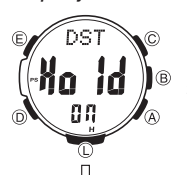

DST indicator

1. In the World Time Mode, use (A) (East) and (C) (West) to scroll through the available city codes.
 - Keep scrolling until the city code whose Standard Time/Daylight Saving Time setting you want to change is displayed.
2. Hold down (E) for at least two seconds.
 - Keep (E) depressed until the current setting (DST Hold ON or DST Hold OFF) starts to flash on the display.
 - DST Hold ON means that summer time is enabled, and that the current time is advanced accordingly. DST Hold OFF means that summer time is disabled, and that the current time shows standard time.
 - This toggles the city code you selected in step 1 between Daylight Saving Time (DST indicator displayed) and standard time (DST indicator not displayed).
 - Using the World Time Mode to change the DST setting of the city code that is selected as your Home City also will change the Timekeeping Mode time DST setting.
 - Note that you cannot switch between standard time/daylight saving time (DST) while UTC is selected as the World Time City.
 - Note that the standard time/daylight saving time (DST) setting affects only the currently selected time zone. Other time zones are not affected.

E-86

E-87

Illumination



The display of the watch is illuminated for easy reading in the dark. The watch's auto light switch turns on illumination automatically when you angle the watch towards your face.

- The auto light switch must be turned on (page E-90) for it to operate.

To turn on illumination manually

- Press **(D)** in any mode to illuminate the display.
- You can use the procedure below to select either 1.5 seconds or three seconds as the illumination duration. When you press **(D)**, the display will remain illuminated for about 1.5 seconds or three seconds, depending on the current illumination duration setting.
 - The above operation turns on illumination regardless of the current auto light switch setting.
 - Illumination is disabled while configuring sensor measurement mode settings, and during bearing sensor calibration.

To change the illumination duration

1. In the Timekeeping Mode, hold down **(E)** for at least two seconds. First, **SET Hold** will flash on the display, and **CITY** will be displayed in the upper display. After that, the currently selected city code and city name will scroll across the upper display. Keep **(E)** depressed until the scrolling starts.

E-88

2. Use **(D)** to cycle through the setting screens until **LIGHT** appears in the upper display.
 - The current illumination duration setting (1 or 3) will be flashing in the middle display.
 - See the sequence in step 2 of the procedure under "To change the current time and date settings" (page E-22) for information about how to scroll through setting screens.
3. Press **(A)** to toggle the illumination duration between three seconds (**3** displayed) and 1.5 seconds (**1** displayed).
4. After all of the settings are the way you want, press **(E)** twice to exit the setting screen.

About the Auto Light Switch

Turning on the auto light switch causes illumination to turn on, whenever you position your wrist as described below in any mode.

Moving the watch to a position that is parallel to the ground and then tilting it towards you more than 40 degrees causes illumination to turn on.



Warning!

- **Always make sure you are in a safe place whenever you are reading the display of the watch using the auto light switch. Be especially careful when running or engaged in any other activity that can result in accident or injury. Also take care that sudden illumination by the auto light switch does not startle or distract others around you.**
- **When you are wearing the watch, make sure that its auto light switch is turned off before riding on a bicycle or operating a motorcycle or any other motor vehicle. Sudden and unintended operation of the auto light switch can create a distraction, which can result in a traffic accident and serious personal injury.**

Note

- This watch features a "Full Auto Light", so the auto light switch operates only when available light is below a certain level. It does not illuminate the display under bright light.
- The auto light switch is always disabled, regardless of its on/off setting, when any one of the following conditions exists.

While an alarm is sounding

While a bearing sensor calibration operation is being performed in the Digital Compass Mode

While a sunrise or sunset time is being calculated

While in a sensor mode, an auto light switch operation is performed after a sensor reading

To turn the auto light switch on and off



Auto light switch on indicator

In the Timekeeping Mode, hold down **(D)** for at least three seconds to toggle the auto light switch on (**LT** displayed) and off (**LT** not displayed).

- The auto light switch on indicator (**LT**) is on the display in all modes while the auto light switch is turned on.
- The auto light switch turns off automatically whenever battery power drops to Level 4 (page E-11).

E-90

Illumination Precautions

- The LED that provides illumination loses power after very long use.
- Illumination may be hard to see when viewed under direct sunlight.
- Illumination turns off automatically whenever an alarm sounds.
- Frequent use of illumination runs down the battery.

Auto light switch precautions

- Wearing the watch on the inside of your wrist, movement of your arm, or vibration of your arm can cause frequent activation of the auto light switch and illumination of the display. To avoid running down the battery, turn off the auto light switch whenever engaging in activities that might cause frequent illumination of the display.

- Note that wearing the watch under your sleeve while the auto light switch is turned on can cause frequent illumination of the display and can run down the battery.



- Illumination may not turn on if the face of the watch is more than 15 degrees above or below parallel. Make sure that the back of your hand is parallel to the ground.
- Illumination turns off after the preset illumination duration (page E-88), even if you keep the watch pointed towards your face.
- Static electricity or magnetic force can interfere with proper operation of the auto light switch. If illumination does not turn on, try moving the watch back to the starting position (parallel with the ground) and then tilt it back towards your face again. If this does not work, drop your arm all the way down so it hangs at your side, and then bring it back up again.
- You may notice a very faint clicking sound coming from the watch when it is shaken back and forth. This sound is caused by mechanical operation of the auto light switch, and does not indicate a problem with the watch.

E-89

E-91

Other Settings

The button operation tone sounds any time you press one of the watch's buttons. You can turn the button operation tone on or off as desired.

- Even if you turn off the button operation tone, the alarm, Hourly Time Signal, barometric pressure change alert, and Countdown Timer Mode alarm all operate normally.

To turn the button operation tone on and off

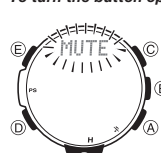

Mute indicator

1. In the Timekeeping Mode, hold down **(E)** for at least two seconds. First, **SET Hold** will flash on the display, and **CITY** will be displayed in the upper display. After that, the currently selected city code and city name will scroll across the upper display. Keep **(E)** depressed until the scrolling starts.

2. Use **(D)** to cycle through settings on the display until the current button operation tone (**MUTE** or **key ♪**) is displayed.
 - See the sequence in step 2 of the procedure under "To change the current time and date settings" (page E-22) for information about how to scroll through setting screens.

3. Press **(A)** to toggle the button operation tone on (**key ♪**) and off (**MUTE**).

4. After all of the settings are the way you want, press **(E)** twice to exit the setting screen.

Note

- The mute indicator is displayed in all modes when the button operation tone is turned off.

E-92

To turn Power Saving on or off



Power saving on indicator

1. In the Timekeeping Mode, hold down **(E)** for at least two seconds. First, **SET Hold** will flash on the display, and **CITY** will be displayed in the upper display. After that, the currently selected city code and city name will scroll across the upper display. Keep **(E)** depressed until the scrolling starts.

2. Use **(D)** to cycle through the setting screens until the current power saving setting (**On** or **OFF**) is displayed.
 - **POWER SAVING** will scroll across the upper display at this time.
 - See the sequence in step 2 of the procedure under "To change the current time and date settings" (page E-22) for information about how to scroll through setting screens.

3. Press **(A)** to toggle Power Saving on (**On**) and off (**OFF**).

4. After all of the settings are the way you want, press **(E)** twice to exit the setting screen.

Note

- The Power Saving on indicator (**PS**) is on the display in all modes while Power Saving is turned on.

E-93

Troubleshooting

Time Setting

■ The current time setting is off by hours.

Your Home City setting may be wrong (page E-20). Check your Home City setting and correct it, if necessary.

■ The current time setting is off by one hour.

You may need to change your Home City's standard time/daylight saving time (DST) setting. Use the procedure under "To change the current time and date settings" (page E-22) to change the standard time/daylight saving time (DST) setting.

Altitude Readings

■ Altitude readings produce different results at the same location.

- Readings produced by the watch are different from the elevation and/or sea level altitude indications in my area. (Negative sea level altitude values are produced in a location where the indicated elevation is a positive value.)

■ I can't get correct altitude readings.

Relative altitude is calculated based on changes in barometric pressure measurement by its pressure sensor. This means that barometric pressure changes can cause readings taken at different times at the same location to be different. Also note that the value displayed by the watch may be different from the actual elevation and/or sea level elevation indicated for the area where you are located.

When using the altimeter of this watch for mountain climbing or other activities, it is highly recommended that you check a map, local altitude indications, or some other source for your current correct altitude and regularly calibrate the altimeter with the latest information.

For more information, see "To specify a reference altitude value" (page E-55).

Taking Direction Readings

■ ERR appears on the digital display during sensor reading operations.

There is something wrong with the sensor. This could be due to nearby strong magnetic force. Move location where magnetism is not present and try again. If, after multiple retries, **ERR** keeps appearing, contact your original retailer or CASIO service center. See "Location" (page E-34).

■ ERR appears following bidirectional calibration.

If the screen displays dashes (---) followed by the **ERR** (error) indicator, it could mean there is something wrong with the sensor.

- Wait for about one second for the **ERR** indicator to disappear from the display, and then calibrate the sensor again.
- If **ERR** continues to appear even after multiple attempts to calibrate, contact your original retailer or CASIO service center.

E-94

E-95

■ The direction information indicated by the watch is different from that indicated by a backup compass.

- Move away from and potential source of strong magnetism, perform bidirectional calibration, and then try taking a reading again. For more information, refer to "To perform bidirectional calibration" (page E-29) and "Location" (page E-34).

■ Direction readings produce different results at the same location.

- Move away from any potential source of strong magnetism and try taking a reading again. See "Location" (page E-34).

■ I am having problems taking direction readings indoors.

- Move away from any potential source of strong magnetism and try taking a reading again. See "Location" (page E-34).

Whenever you have a sensor malfunction, take the watch to your original retailer or nearest authorized CASIO distributor as soon as possible.

Barometric Pressure Readings

■ The barometric pressure differential pointer does not appear on the display when I enter the Barometer/Thermometer Mode.

- This could indicate sensor error. Try pressing **(B)** again.
- The barometric pressure differential pointer is not displayed when the displayed current barometric value is outside of the allowable measurement range (260 to 1,100 hPa).

E-96

Direction, Altitude, Barometric Pressure, and Temperature Readings

■ I can't change the temperature, barometric pressure, and altitude display units.

When **TYO** (Tokyo) is selected as the Home City, the altitude unit is set automatically to meters (m), the barometric pressure unit to hectopascals (hPa), and the temperature unit to Celsius (°C). These settings cannot be changed.

■ "ERR" appears on the display while I am using a sensor.

Subjecting the watch to strong impact can cause sensor malfunction or improper contact of internal circuitry. When this happens, **ERR** (error) will appear on the display and sensor operations will be disabled.

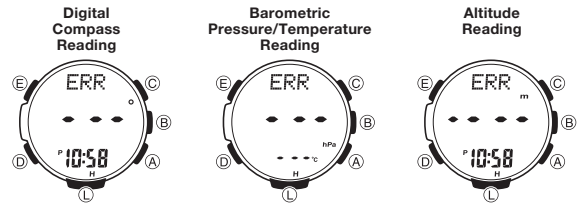

- If **ERR** appears while a reading operation is being performed in a sensor mode, restart the operation. If **ERR** appears on the display again, it can mean there is something wrong with the sensor.

E-97

- Even if battery power is at Level 1 (**H**) or Level 2 (**M**), the Digital Compass Mode, Barometer/Thermometer Mode, or Altimeter Mode sensor may become momentarily disabled if there is not enough voltage available to power it sufficiently. In this case, **ERR** will appear on the display. This does not indicate malfunction, and sensor operation should resume once battery voltage returns to its normal level.
- If **ERR** keeps appearing during a reading operation, it could mean there is a problem with the applicable sensor.

World Time Mode

■ The time for my World Time City is off in the World Time Mode.

This could be due to incorrect switching between standard time and daylight saving time. See "To specify standard time or daylight saving time (DST) for a city" (page E-87) for more information.

Charging

■ The watch does not resume operation after I expose it to light.

This can happen after the power level drops to Level 5 (page E-11). Continue exposing the watch to light until the battery power indicator shows "**H**" or "**M**".

E-98

Specifications

Accuracy at normal temperature: ±15 seconds a month

Timekeeping: Hour, minute, second, p.m. (P), year, month, day, day of the week

Time format: 12-hour and 24-hour

Calendar system: Full Auto-calendar pre-programmed from the year 2000 to 2099

Other: Three display formats (day of the week/day screen, month/day screen, barometric pressure graph screen); Home City code (can be assigned one of 48 city codes); Standard Time / Daylight Saving Time (summer time)
Year display on setting screen only.

Digital Compass: 60 seconds continuous reading; 16 directions; Angle value 0° to 359°; Four direction pointers; Calibration (bidirectional); Magnetic declination correction; Bearing Memory

Barometer:

Measurement and display range: 260 to 1,100 hPa (or 7.65 to 32.45 inHg)

Display unit: 1 hPa (or 0.05 inHg)

Reading timing: Daily from midnight, at two-hour intervals (12 times per day); Every five seconds in the Barometer/Thermometer Mode

Other: Calibration; Manual reading (button operation); Barometric pressure graph; Barometric pressure differential pointer; Barometric pressure change indicator

Thermometer:

Measurement and display range: -10.0 to 60.0°C (or 14.0 to 140.0°F)

Display unit: 0.1°C (or 0.2°F)

Reading timing: Every five seconds in the Barometer/Thermometer Mode

Other: Calibration; Manual reading (button operation)

Altimeter:

Measurement range: -700 to 10,000 m (or -2,300 to 32,800 ft.) without reference altitude

Display range: -10,000 to 10,000 m (or -32,800 to 32,800 ft.)

Negative values can be caused by readings produced based on a reference altitude or due to atmospheric conditions.

Display unit: 1 m (or 5 ft.)

Current Altitude Data: Every second for the first 3 minutes, followed by every 5 seconds for approximately 1 hour (**0'05**); every second for the first 3 minutes, followed by every 2 minutes for approximately 12 hours (**2'00**)

Altitude Memory Data:

Manually saved records: 30 (altitude, date, time)

Auto saved values: One set of high altitude and its reading date and time, low altitude and its reading date and time, total ascent and its save start date and time, total descent and its save start date and time

Trek log data: High altitude, low altitude, cumulative ascent, cumulative descent for up to 14 treks

Other: Reference altitude setting; Altitude differential; Altitude auto measurement interval (**0'05** or **2'00**)

Bearing Sensor Precision:

Direction: Within ±10°

Values are guaranteed for a temperature range of -10°C to 60°C (14°F to 140°F).

North pointer: Within ±2 digital segments

Pressure Sensor Precision:

Measurement accuracy: Within ±3hPa (0.1 inHg) (Altimeter accuracy: Within ± 75m (246 ft.))

• Values are guaranteed for a temperature range of -10°C to 40°C (14°F to 104°F).

• Precision is lessened by strong impact to either the watch or the sensor, and by temperature extremes.

E-100

Temperature Sensor Precision:

±2°C (±3.6°F) in range of -10°C to 60°C (14.0°F to 140.0°F)

Sunrise/sunset:

Sunrise/sunset time display; selectable date

Stopwatch:

Measuring unit: 1/10 second

Measuring capacity: 999:59' 59.9"

Measuring accuracy: ±0.0006%

Measuring modes: Elapsed time, split time, two finishes

Countdown Timer:

Measuring unit: 1 second

Countdown range: 24 hours

Setting unit: 1 minute

Alarms: 5 Daily alarms (with one snooze alarm); Hourly time signal

World Time: 48 cities (31 time zones)

Other: Daylight Saving Time/Standard Time

Illumination: LED light; Selectable illumination duration (approximately 1.5 seconds or 3 seconds); Auto Light Switch (Full Auto Light operates only in the dark)

Other: Battery power indicator; Power Saving; Low-temperature resistance (-10°C/14°F); Button operation tone on/off

Power Supply: Solar panel and one rechargeable battery

Approximate battery operating time: 8 months (from full charge to Level 4) under the following conditions:

- Light: 1.5 seconds/day
- Beeper: 10 seconds/day
- Direction readings: 20 times/month
- Climbs: Once (approximately 1 hour of altitude readings)/month
- Barometric pressure change indicator readings: Approximately 24 hours/month
- Barometric pressure graph: Readings every 2 hours
- Display: 18 hours/day

Frequent use of illumination runs down the battery. Particular care is required when using the auto light switch (page E-91).

Specifications are subject to change without notice.

E-102

Operating Precautions

Water Resistance

- The information below applies to watches with WATER RESIST or WATER RESISTANT marked on the back cover.

Marking	On watch front or on back cover	Water Resistance Under Daily Use	Enhanced Water Resistance Under Daily Use		
			5 Atmospheres	10 Atmospheres	20 Atmospheres
		No BAR mark	5BAR	10BAR	20BAR
Example of Daily Use	Hand washing, rain	Yes	Yes	Yes	Yes
	Water-related work, swimming	No	Yes	Yes	Yes
	Windsurfing	No	No	Yes	Yes
	Skin diving	No	No	Yes	Yes

- Do not use your watch for scuba diving or other types of diving that requires air tanks.
- Watches that do not have WATER RESIST or WATER RESISTANT marked on the back cover are not protected against the effects of sweat. Avoid using such a watch under conditions where it will be exposed to large amounts of sweat or moisture, or to direct splashing with water.

- Even if a watch is water resistant, note the usage precautions described below. Such types of use reduce water resistance performance and can cause fogging of the glass.
 - Do not operate the crown or buttons while your watch is submerged in water or wet.
 - Avoid wearing your watch while in the bath.
 - Do not wear your watch while in a heated swimming pool, sauna, or any other high temperature/high humidity environment.
 - Do not wear your watch while washing your hands or face, while doing housework, or while performing any other task that involves soaps or detergents.
- After submersion in seawater, use plain water to rinse all salt and dirt from your watch.
- To maintain water resistance, have the gaskets of your watch replaced periodically (about once every two or three years).
- A trained technician will inspect your watch for proper water resistance whenever you have its battery replaced. Battery replacement requires the use of special tools. Always request battery replacement from your original retailer or from an authorized CASIO service center.
- Some water-resistant watches come with fashionable leather bands. Avoid swimming, washing, or any other activity that causes direct exposure of a leather band to water.
- The inside surface of the watch glass may fog when the watch is exposed to a sudden drop in temperature. No problem is indicated if the fogging clears up relatively quickly. Sudden and extreme temperature changes (such as coming into an air conditioned room in the summer and standing close to an air conditioner outlet, or leaving a heated room in the winter and allowing your watch to come into contact with snow) can cause it to take longer for glass fogging to clear up. If glass fogging does not clear up or if you notice moisture inside of the glass, immediately stop using your watch and take it to your original retailer or to an authorized CASIO service center.
- Your water-resistant watch has been tested in accordance with International Organization for Standardization regulations.

E-104

E-105

Impact

- Your watch is designed to withstand impact incurred during normal daily use and during light activity such as playing catch, tennis, etc. Dropping your watch or otherwise subjecting it to strong impact, however, can lead to malfunction. Note that watches with shock-resistant designs (G-SHOCK, BABY-G, G-MS) can be worn while operating a chain saw or engaging in other activities that generate strong vibration, or while engaging in strenuous sports activities (motocross, etc.)

Magnetism

- Though operation of your watch normally is not affected by magnetism, its accuracy may be affected if the watch itself becomes magnetized. Also, very strong magnetism (from medical equipment, etc.) should be avoided because it can cause malfunction of your watch and damage to electronic components.

Electrostatic Charge

- Exposure to very strong electrostatic charge can cause your watch to display the wrong time. Very strong electrostatic charge even can damage electronic components.
- Electrostatic charge can cause the display to go blank momentarily or cause a rainbow effect on the display.

Chemicals

- Do not allow your watch to come into contact with thinner, gasoline, solvents, oils, or fats, or with any cleaners, adhesives, paints, medicines, or cosmetics that contain such ingredients. Doing so can cause discoloration of or damage to the resin case, resin band, leather, and other parts.

E-106

E-107

Leather Band

- Allowing your watch to remain in contact with other items or storing it together with other items for long periods while it is wet can cause the color of the leather band to transfer to the other items or the color of the other items to transfer to the leather band. Be sure to dry off your watch thoroughly with a soft cloth before storing it and make sure it is not in contact with other items.
- Leaving a leather band where it is exposed to direct sunlight (ultraviolet rays) for long periods or failure to clean dirt from a leather band for long periods can cause it to become discolored.

CAUTION: Exposing a leather band to rubbing or dirt can cause color transfer and discoloration.

Metal Components

- Failure to clean dirt from metal components can lead to formation of rust, even if components are stainless steel or plated. If metal components exposed to sweat or water, wipe thoroughly with a soft, absorbent cloth and then place the watch in a well-ventilated location to dry.
- Use a soft toothbrush or similar tool to scrub the metal with a weak solution of water and a mild neutral detergent, or with soapy water. Next, rinse with water to remove all remaining detergent and then wipe dry with a soft absorbent cloth. When washing metal components, wrap the watch case with kitchen plastic wrap so it does not come into contact with the detergent or soap.

Bacteria and Odor Resistant Band

- The bacteria and odor resistant band protects against odor generated by the formation of bacteria from sweat, which ensures comfort and hygiene. In order to ensure maximum bacteria and odor resistance, keep the band clean. Use an absorbent soft cloth to thoroughly wipe the band clean of dirt, sweat, and moisture. A bacteria and odor resistant band suppresses the formation of organisms and bacteria. It does not protect against rash due to allergic reaction, etc.

E-108

E-109

User Maintenance

Caring for Your Watch

Remember that you wear your watch next to your skin, just like a piece of clothing. To ensure your watch performs at the level for which it is designed, keep it clean by frequently wiping with a soft cloth to keep your watch and band free of dirt, sweat, water and other foreign matter.

- Whenever your watch is exposed to sea water or mud, rinse it off with clean fresh water.
- For a metal band or a resin band with metal parts, use a soft toothbrush or similar tool to scrub the band with a weak solution of water and a mild neutral detergent, or with soapy water. Next, rinse with water to remove all remaining detergent and then wipe dry with a soft absorbent cloth. When washing the band, wrap the watch case with kitchen plastic wrap so it does not come into contact with the detergent or soap.
- For a resin band, wash with water and then wipe dry with a soft cloth. Note that sometimes a smudge like pattern may appear on the surface of a resin band. This will not have any effect on your skin or clothing. Wipe with a cloth to remove the smudge pattern.
- Clean water and sweat from a leather band by wiping with a soft cloth.
- Not operating a watch crown, buttons, or rotary bezel could lead to later problems with their operation. Periodically rotate the crown and rotary bezel, and press buttons to maintain proper operation.

Dangers of Poor Watch Care

Rust

- Though the metal steel used for your watch is highly rust-resistant, rust can form if your watch is not cleaned after it becomes dirty.
 - Dirt on your watch can make it impossible for oxygen to come into contact with the metal, which can lead to breakdown of the oxidization layer on the metal surface and the formation of rust.

E-110

Band

- Tightening the band too tightly can cause you to sweat and make it difficult for air to pass under the band, which can lead to skin irritation. Do not fasten the band too tightly. There should be enough room between the band and your wrist so you can insert your finger.
- Deterioration, rust, and other conditions can cause the band to break or come off of your watch, which in turn can cause band pins to fly out of position or to fall out. This creates the risk of your watch falling from your wrist and becoming lost, and also creates the risk of personal injury. Always take good care of your band and keep it clean.
- Immediately stop using a band if you even notice any of the following: loss of band flexibility, band cracks, band discoloration, band looseness, band connecting pin flying or falling out, or any other abnormality. Take your watch to your original retailer or to a CASIO service center for inspection and repair (for which you will be charged) or to have the band replaced (for which you will be charged).

Temperature

- Never leave your watch on the dashboard of a car, near a heater, or in any other location that is subject to very high temperatures. Do not leave your watch where it will be exposed to very low temperatures. Temperature extremes can cause your watch to lose or gain time, to stop, or otherwise malfunction.
- Leaving your watch in an area hotter than +60°C (140°F) for long periods can lead to problems with its LCD. The LCD may become difficult to read at temperatures lower than 0°C (32°F) and greater than +40°C (104°F).

Storage

- If you do not plan to use your watch for a long time, thoroughly wipe it free of all dirt, sweat, and moisture, and store it in a cool, dry place.

Resin Components

- Allowing your watch to remain in contact with other items or storing it together with other items for long periods while it is wet can cause color on resin components to transfer to the other items, or the color of the other items to transfer to the resin components of your watch. Be sure to dry off your watch thoroughly before storing it and make sure it is not in contact with other items.
- Leaving your watch where it is exposed to direct sunlight (ultraviolet rays) for long periods or failure to clean dirt from your watch for long periods can cause it to become discolored.
- Friction caused by certain conditions (strong external force, sustained rubbing, impact, etc.) can cause discoloration of painted components.
- If there are printed figures on the band, strong rubbing of the printed area can cause discoloration.
- Leaving your watch wet for long periods can cause fluorescent color to fade. Wipe the watch dry as soon as possible after it becomes wet.
- Semi-transparent resin parts can become discolored due to sweat and dirt, and if exposed to high temperatures and humidity for long periods.
- Daily use and long-term storage of your watch can lead to deterioration, breaking, or bending of resin components. The extent of such damage depends on usage conditions and storage conditions.

Liquid Crystal Display

- Display figures may be difficult to read when viewed from an angle.

Watch with Data Memory

- Allowing the battery to go dead, replacing the battery, or having your watch repaired can cause all data in watch memory to be lost. Note that CASIO COMPUTER CO., LTD. assumes no responsibility for any damages or losses caused by data lost due to malfunction or repair of your watch, replacement of the battery, etc. Be sure to keep separate written copies of all important data.

Watch Sensors

- A watch sensor is a precision instrument. Never try to take it apart. Never try to insert any objects into the openings of a sensor, and take care to ensure that dirt, dust, or other foreign matter does not get into it. After using your watch where it has been immersed in saltwater, rinse it thoroughly with fresh water.

- Rust can cause sharp areas on metal components and can cause band pins to fly out of position or to fall out. If you ever notice any abnormality immediately stop using your watch and take it to your original retailer or to an authorized CASIO service center.
- Even if the surface of the metal appears clean, sweat and rust in crevasses can soil the sleeves of clothing, cause skin irritation, and even interfere with watch performance.

Premature Wear

- Leaving sweat or water on a resin band or bezel, or storing your watch in an area subject to high moisture can lead to premature wear, cuts, and breaks.

Skin Irritation

- Individuals with sensitive skin or in poor physical condition may experience skin irritation when wearing a watch. Such individuals should keep their leather band or resin band particularly clean. Should you ever experience a rash or other skin irritation, immediately remove your watch and contact a skin care professional.

Battery

- The special rechargeable battery used by your watch is not intended to be removed or replaced by you. Use of a rechargeable battery other than the special one specified for your watch can damage your watch.
- The rechargeable (secondary) battery is charged when the solar panel is exposed to light, so it does not require regular replacement as the primary battery requires. Note, however, that long use or operating conditions can cause the capacity or charging efficiency of the rechargeable battery to deteriorate. If you feel that the amount of operation provided by charging is too short, contact your original retailer or CASIO service center.

E-111



City Code Table

City Code Table

City Code	City	UTC Offset/ GMT Differential
PPG	Pago Pago	-11
HNL	Honolulu	-10
ANC	Anchorage	-9
YVR	Vancouver	-8
LAX	Los Angeles	-8
YEA	Edmonton	-7
DEN	Denver	-7
MEX	Mexico City	-6
CHI	Chicago	-6
NYC	New York	-5
SCL	Santiago	-4
YHZ	Halifax	-4
YYT	St. Johns	-3.5
RIO	Rio De Janeiro	-3
FEN	Fernando de Noronha	-2
RAI	Praia	-1
UTC		
LIS	Lisbon	0
LON	London	

City Code	City	UTC Offset/ GMT Differential
MAD	Madrid	
PAR	Paris	
ROM	Rome	+1
BER	Berlin	
STO	Stockholm	
ATH	Athens	
CAI	Cairo	+2
JRS	Jerusalem	
MOW	Moscow	+3
JED	Jeddah	
THR	Tehran	+3.5
DXB	Dubai	+4
KBL	Kabul	+4.5
KHI	Karachi	+5
DEL	Delhi	+5.5
KTM	Kathmandu	+5.75
DAC	Dhaka	+6
RGN	Yangon	+6.5
BKK	Bangkok	+7

L

L-1

City Code	City	UTC Offset/ GMT Differential
SIN	Singapore	
HKG	Hong Kong	
BJS	Beijing	+8
TPE	Taipei	
SEL	Seoul	+9
TYO	Tokyo	
ADL	Adelaide	+9.5
GUM	Guam	+10
SYD	Sydney	
NOU	Noumea	+11
WLG	Wellington	+12

- This table shows the city codes of this watch. (As of July 2020)
- The rules governing global times (GMT differential and UTC offset) and summer time are determined by each individual country.

CASIO®

CASIO COMPUTER CO., LTD.
6-2, Hon-machi 1-chome
Shibuya-ku, Tokyo 151-8543, Japan

L-2