



PX-S3000

USER'S GUIDE (Basics)

Please keep all information for future reference. Be sure to read the separate "Safety Precautions" and use the Digital Piano correctly.

These instructions provide general information about Digital Piano operations. For more detailed information, refer to the User's Guide available on the CASIO website, which you can access using the nearby QR code or the URL below.
<https://support.casio.com/global/en/emi/manual/PX-S3000/>

When the Digital Piano is being operated on battery power only, notes may sound distorted when performing or playing back a song at maximum volume. This is due to the difference between AC adaptor power and battery power, and does not indicate Digital Piano malfunction. If you notice distortion, switch to AC adaptor power or lower the volume level.

Supported Operations

- 700 tones for keyboard play**
≡ THESE INSTRUCTIONS: Selecting a Tone (page 2/4)
- Auto Accompaniment**
≡ THESE INSTRUCTIONS: Using Auto Accompaniment (page 2/4)
- Performance recording**
 - Storage of recordings as MIDI data
≡ THESE INSTRUCTIONS: Using the MIDI Recorder to Record Performances (page 3/4)
 - Storage of recordings as audio files
≡ THESE INSTRUCTIONS: Using the Audio Recorder to Record Performances (page 3/4)
- Registration Function**
≡ THESE INSTRUCTIONS: Registering and Restoring a Setup (Registration) (page 3/4)
- Bluetooth connectivity for playing external device audio through Digital Piano speakers**
≡ THESE INSTRUCTIONS: Using the Digital Piano as a Bluetooth Speaker System (page 4/4)
- Adjustable Touch Response**
≡ THESE INSTRUCTIONS: Changing Keyboard Response to Touch Pressure (Touch Response) (page 2/4)
- Key transposition**
≡ THESE INSTRUCTIONS: Changing the Pitch in Semitone Steps (Transpose) (page 2/4)
- Hall simulator and surround effects**
≡ THESE INSTRUCTIONS: Using the Sound Mode Effects (Hall Simulator/Reverb and Surround) (page 2/4)
- Duet Mode**
≡ THESE INSTRUCTIONS: Splitting the Keyboard for Duet Play (page 3/4)
- Auto arpeggio play**
≡ THESE INSTRUCTIONS: Using the Arpeggiator (page 2/4)

- Pitch bending of notes played on the keyboard**
≡ THESE INSTRUCTIONS: Using the Pitch Bend Wheel (page 2/4)
- Two knobs for control of tones and effects**
≡ THESE INSTRUCTIONS: Using the Knobs (page 2/4)
- MIDI data playback**
≡ THESE INSTRUCTIONS: Listening to Songs (MIDI Player) (page 3/4)
- Smart device linking for enhanced function**
≡ THESE INSTRUCTIONS: Linking with a Smart Device (APP Function) (page 4/4)

- Other useful features**
 - Acoustic piano sound characteristic adjustment (Acoustic Simulator)
 - DSP, Chorus, and Brilliance effects
 - Keyboard pitch adjustment (Tuning, Octave Shift)
 - 17 scales including equal temperament (Scale Tuning)
 - Audio output to external equipment
 - Connection to a computer for performance information (MIDI data) exchange
 - Versatile tones (for computer music)
- ≡ CASIO WEBSITE: "User's Guide", "Bluetooth, Audio Device, and Computer Connection Guide"
- Troubleshooting**
≡ CASIO WEBSITE: User's Guide

Included Accessories

- Music Stand
- AC adaptor
- Power cord
- Pedal
- Leaflets
 - Safety Precautions
 - Other (Warranty, etc.)

Items included as accessories are subject to change without notice.

Separately Available Accessories

You can get information about accessories that are separately available for this product from the CASIO catalog available from your retailer, and from the CASIO website at the URL or QR code below.
<https://support.casio.com/global/en/emi/manual/PX-S3000/>

Getting Ready

Preparing a Power Supply

Using the AC Adaptor

Make sure that you use only the AC adaptor specified for this Digital Piano. Use of a different type of AC adaptor can cause malfunction.

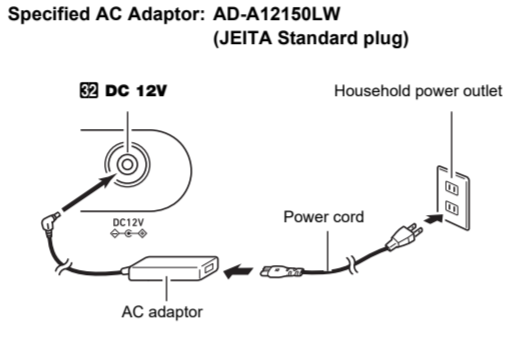

IMPORTANT!

- Never connect the AC adaptor (JEITA Standard, with unified polarity plug) that comes with this Digital Piano to any other device besides this Digital Piano. Doing so creates the risk of malfunction.
- Be sure to turn off Digital Piano power before connecting or disconnecting the AC adaptor.
- The AC adaptor will become warm to the touch after very long use. This is normal and does not indicate malfunction.

Using Batteries

IMPORTANT!

- Be sure to turn off power before loading batteries.
- It is up to you to prepare six commercially available alkaline batteries.
- Note the following precautions while the Digital Piano is turned upside down to load batteries.
 - Take care to avoid injury due to pinching your fingers under the Digital Piano.
 - Do not allow the Digital Piano to tip over or otherwise be subjected to strong impact. Impact can damage the volume knob and keyboard keys.

- Open the battery cover on the bottom of the Digital Piano.
- Load six AA-size batteries into the battery compartment. Make sure the positive (+) and negative (-) ends of the batteries are facing as marked on the Digital Piano.
- Insert the tabs of the battery cover into the holes on the side of the battery compartment, and close the cover.

Low Battery Indication

The message "LOW BATTERY" appears on the display when battery power goes low. When this happens, replace the batteries.

IMPORTANT!

- Using the Digital Piano while batteries are very low can cause it to turn off suddenly. This can cause data stored in Digital Piano memory to be corrupted or lost.

Turning Power On or Off

- Before turning on power, rotate the **2** volume knob as far as it will go in the direction shown in the illustration below.
- Press the **1** (Power) button to turn on power. The message "Welcome" will appear momentarily, followed by the tone name display. This indicates that the Digital Piano is ready for use.
 - Power may not turn on if you press the **1** (Power) button too lightly. This does not indicate malfunction. If this happens, apply more pressure when you press the **1** (Power) button.
- Use the **2** volume knob to adjust volume.

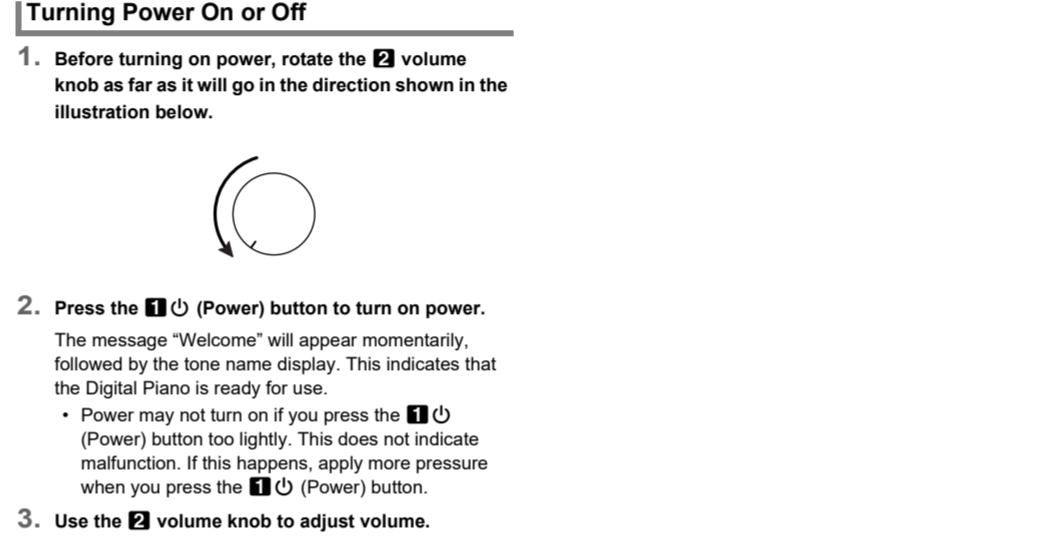

General Guide

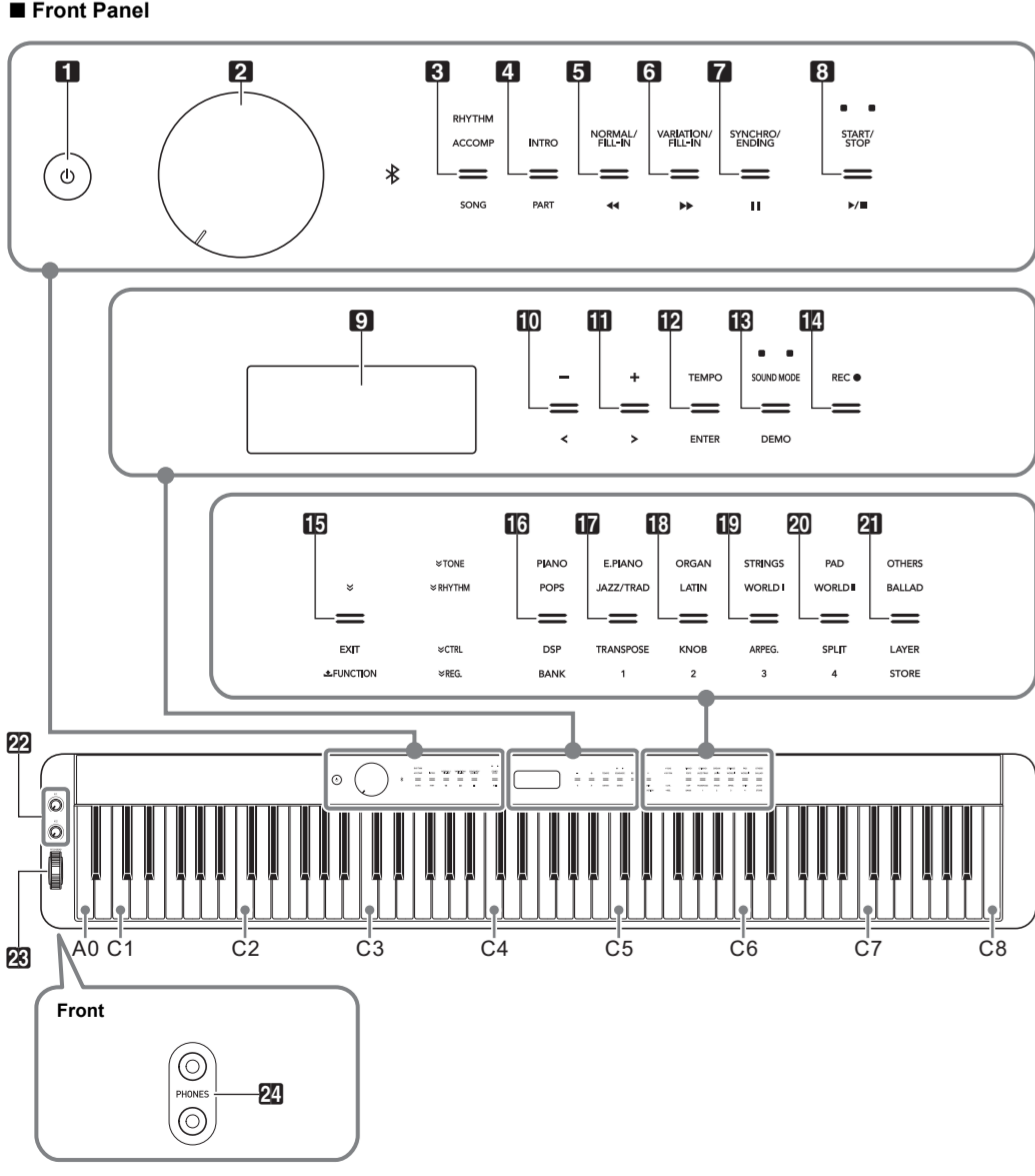

Touch Buttons

Turning on Digital Piano power causes all of the touch buttons to light, except for the **1** (Power) button. The above illustration shows when all buttons and their text are lit. During actual operation, only the buttons that are currently enabled and the applicable text are lit or flashing.

- 1** (Power) button
- 2** Volume knob
- 3** Mode selector button (RHYTHM, ACCOMP, SONG)
- 4** INTRO, PART button
- 5** NORMAL/FILL-IN, ◀◀ button
- 6** VARIATION/FILL-IN, ▶▶ button
- 7** SYNCHRO/ENDING, || button
- 8** START/STOP, ▶■ button
- 9** Display
- 10** -, < button
- 11** +, > button
- 12** TEMPO, ENTER button
- 13** SOUND MODE, DEMO button
- 14** REC ● button
- 15** V, EXIT, ↴ FUNCTION button
- 16** - **21** TONE category, RHYTHM category buttons
- 16** DSP, BANK button
- 17** TRANSPOSE, Area 1 button
- 18** KNOB, Area 2 button
- 19** ARPEG., Area 3 button
- 20** SPLIT, Area 4 button
- 21** LAYER, STORE button
- 22** Knob (K1), Knob (K2)
- 23** PITCH BEND wheel
- 24** PHONES jacks

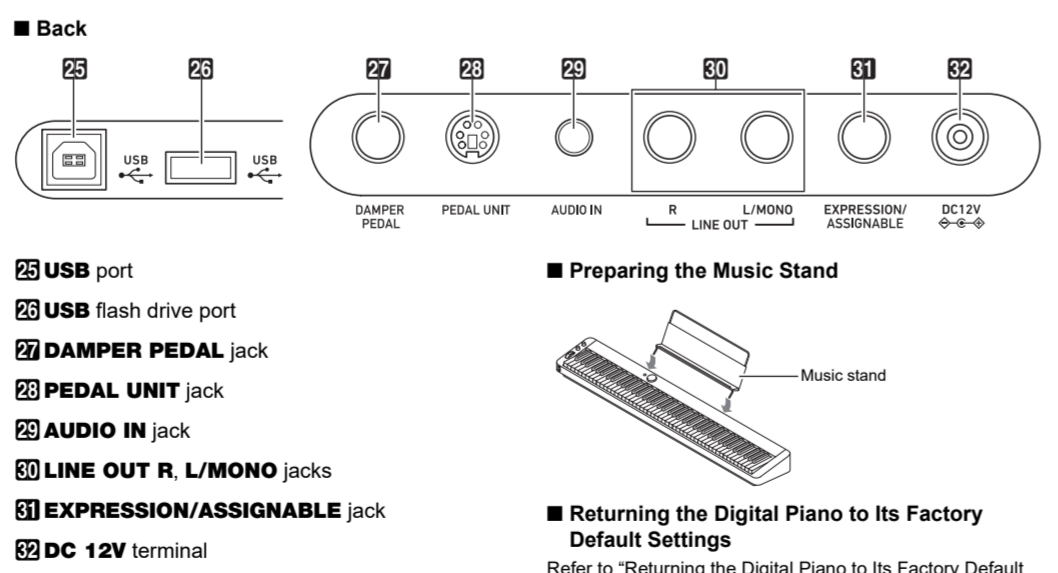

Preparing the Music Stand

Returning the Digital Piano to Its Factory Default Settings

Refer to "Returning the Digital Piano to Its Factory Default Settings" (page 4/4) of these instructions.

Touch Button Operations

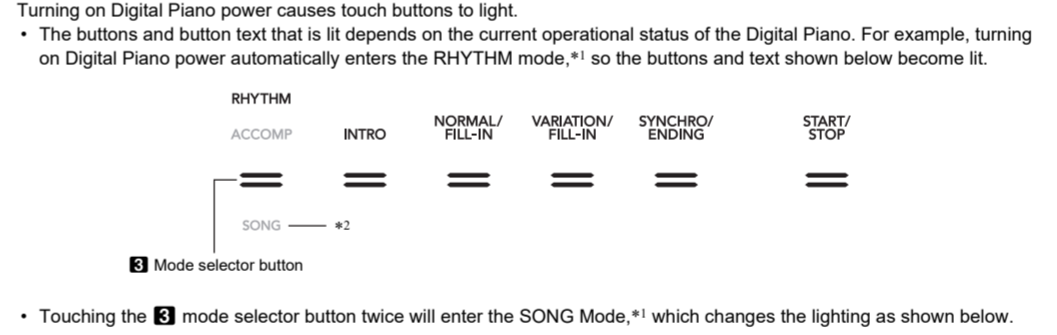

Only the enabled buttons and text indicating available functions are lit or flashing.

*1 For information about these modes, see "Mode Selector Button".

*2 In the illustrations of these instructions, unlit indicator text above and/or below a button is grey. Lit indicator text is black.

IMPORTANT!

- When operating a touch button, touch it firmly with a bare finger. Touch buttons will not respond if you touch them while wearing gloves.
- If a touch button does not respond, perform the steps below to increase touch button sensitivity.

- Turn off the Digital Piano.
- While holding down the C8 keyboard key (the one on the far right), press the **1** (Power) button.
 - Keep the C8 keyboard key depressed until the "Welcome" message appears on the display. You do not need to keep the **1** (Power) button depressed.

Touch Button Light Auto Off (Panel Light Setting)

To save power, you can configure a setting that will turn off all button lights, except for **3** Mode selector, after a certain period of non-operation.
≡ CASIO WEBSITE: User's Guide

Using a Pedal

DAMPER PEDAL jack

Connect the provided Damper Pedal (SP-3) to the Digital Piano's **27** DAMPER PEDAL jack. You can change the function of this pedal by using the following FUNCTION parameter operation: "PEDAL/WHEEL" → "DAMPER PEDAL" → "Pedal Target".

This setting (displayed)	Does this:
1. Sustain (Initial default)	Sustains notes played while the pedal is depressed, even if the keyboard key is subsequently released. Organ and other tones that are sustained as long as keyboard key are depressed continue to sound as long as the pedal is depressed.
2. Sostenuto	Sustains only the notes of the keys that are depressed when the pedal is pressed until the pedal is released, even if the keyboard keys are released first.
3. Soft	Slightly lowers and softens notes played while the pedal is depressed.
4. Arpeggio Hold	When the arpeggiator is enabled, applies arpeggio hold while the pedal is depressed.
5. Start/Stop	Performs the same operations as the 8 START/STOP button.
6. Fill-in	Plays a fill-in when the pedal is depressed while an Auto Accompaniment is playing.

For information about FUNCTION parameters, see "Configuring Function Settings (FUNCTION Mode)" (page 4/4).

PEDAL UNIT jack

≡ CASIO WEBSITE: User's Guide

Use the **28** PEDAL UNIT jack to connect a separately available Pedal Unit (SP-34). You can then use the pedals for expression that is similar to that available on an acoustic piano.

EXPRESSION/ASSIGNABLE jack

≡ CASIO WEBSITE: User's Guide

Use the **31** EXPRESSION/ASSIGNABLE jack to connect a commercially available expression pedal or a CASIO sustain pedal (included SP-3 or separately available pedal).

IMPORTANT!

- For information about connectable expression pedals, be sure to refer to the User's Guide that is available from the CASIO Website.

Using Headphones

Using headphones cuts off output from the built-in speakers, which means you can practice playing even late at night without disturbing others.

- Be sure to turn down the volume level before connecting headphones.

NOTE

- Headphones do not come with the Digital Piano.
- Use commercially available headphones. See "Separately Available Accessories" (this page) for information about options.

IMPORTANT!

- Do not listen to very high volume output over headphones for long period. Doing so creates the risk of hearing damage.
- If you are using headphones that require an adaptor plug, make sure you do not leave the adaptor plugged in when you unplug the headphones. If you do, nothing will sound from the speakers when you play.

Mode Selector Button

Your Digital Piano has three modes, which are described below.

RHYTHM Mode: This is the mode for most basic operations. In addition to normal keyboard play use this mode to perform most other Digital Piano operations.

ACCOMP Mode: This mode is for playing Auto Accompaniment with chords. See "Using Auto Accompaniment" (page 2/4).

SONG Mode: Use this mode to play back songs. See "Listening to Songs (MIDI Player)" (page 3/4).

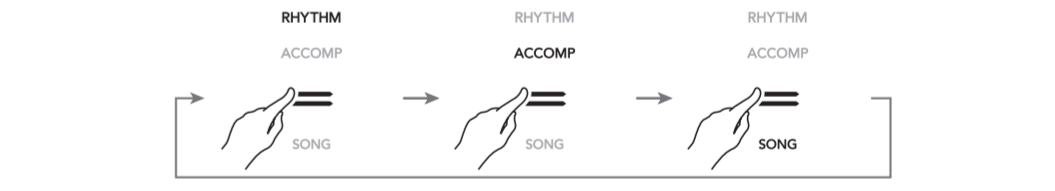

An indicator above or below the mode selector button will light to indicate the currently selected mode. Other mode names are not displayed.

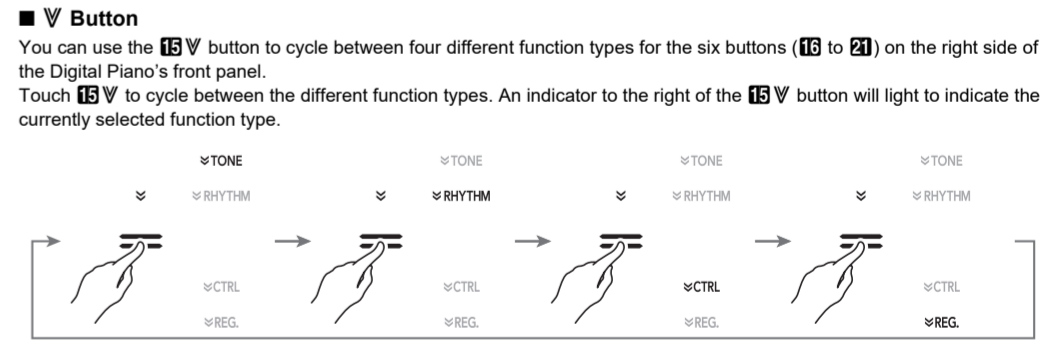

While this function name is lit:	Buttons 16 through 21 perform these operations:
TONE	Tone category selection
RHYTHM	Rhythm category selection
CTRL	DSP selection, transpose setting changes, knob set selection, arpeggiator/auto harmonize setting change, split and layer setting changes
REG.	Registration operations

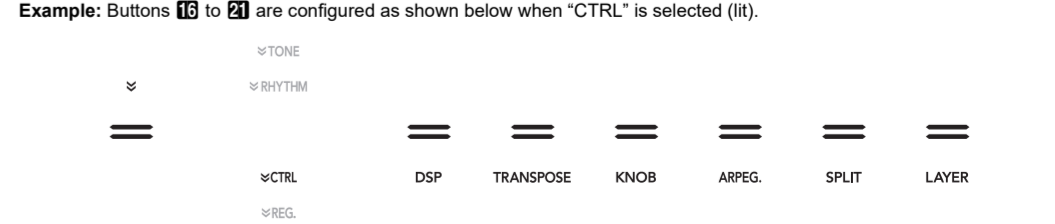

Selecting a Tone

Your Digital Piano comes with a large collection of tones. You can play with a single tone or with two tones simultaneously (Layer). You can also assign separate tones to the high-range (right side) and low range (left side) keyboards (Split).

To select a tone

- Use the **[F5]** button to cycle through settings until the "V TONE" indicator to the right of the button is lit. The currently selected tone category name and tone name will be shown on the display.

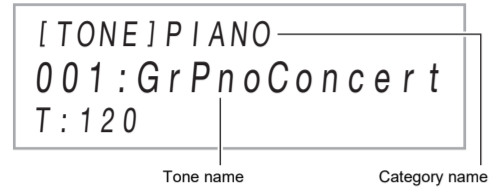

- Use TONE category buttons **[F6]** through **[F9]** to select a tone category.
- Use the **[F0]** - and **[F1]** + buttons to select a tone.

To layer two tones

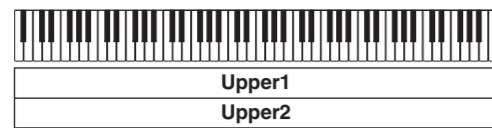

- Use the procedure under "To select a tone" to select the first tone (Upper1 tone).
- Use the **[F5]** button to cycle through settings until the "V CTRL" indicator to the right of the button is lit.
- Touch **[F2]** LAYER to enable the layer function, which is indicated by "LY" on the display.
- Use the **[F5]** button to cycle through settings until the "V TONE" indicator to the right of the button is lit. Next, perform the operation under "To select a tone" to select the Upper2 tone.

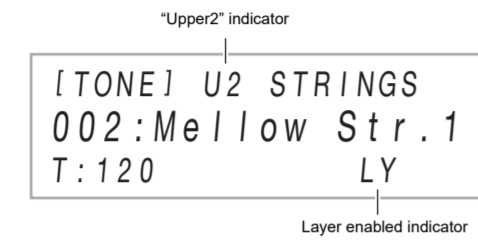

NOTE

- To unlayer the keyboard, use the **[F5]** button to cycle through settings until the "V CTRL" indicator to the right of the button is lit. Next, touch **[F2]** LAYER so the "LY" indicator disappears from the display.

To split the keyboard between two different tones



- Use the procedure under "To select a tone" to select the first tone (Upper1 tone).
- Use the **[F5]** button to cycle through settings until the "V CTRL" indicator to the right of the button is lit.
- Touch **[F0]** SPLIT to enable the split function, which is indicated by "SP" on the display.
- Use the **[F5]** button to cycle through settings until the "V TONE" indicator to the right of the button is lit. Next, perform the operation under "To select a tone" to select the Lower tone.

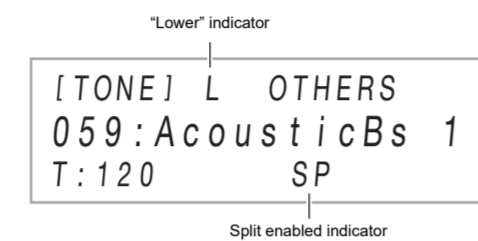

NOTE

- To use split and layer at the same time, perform the procedure above and then continue with steps 2 through 4 under "To layer two tones".
- To unsplit the keyboard, use the **[F5]** button to cycle through settings until the "V CTRL" indicator to the right of the button is lit. Next, touch **[F0]** SPLIT so the "SP" indicator disappears from the display.



Listening to Demo Play

- Hold down the **[F5]** button until "DEMO", under the **[F8]** DEMO button starts to flash.
- Touch **[F8]** DEMO. This causes the **[F8]** DEMO button light and "DEMO" indicator to turn off, which indicates demo play standby. At this time, the display will show "1: Demo Song".
- To start demo play, touch **[F3]** ▶ or **[F2]** ENTER.
 - After this, you can pause and resume demo play by touching **[F3]** ▶ or **[F2]** ENTER.
- To exit demo play standby, touch **[F6]** EXIT.

Changing Keyboard Response to Touch Pressure (Touch Response)

Touch Response alters tone volume in accordance with keyboard pressure (speed). This provides you some of the same expressivity you get on an acoustic piano.

To change touch response sensitivity

- Hold down the **[F5]** button until "[FUNCTION]" appears on the display.
 
- Use the **[F0]** < and **[F1]** > buttons to display "KEYBOARD" and then touch **[F2]** ENTER.
- Use the **[F0]** < and **[F1]** > buttons to display "Touch Response" and then touch **[F2]** ENTER.
 
- Use the **[F0]** - and **[F1]** + buttons, or **[F2]** Knob (K1) to change the setting.

This setting (displayed):	Does this:
Disabled (Off)	Disables Touch Response. Sound volume is fixed, regardless of key press speed.
Light (Light2)	Makes production of a louder sound easier, so touch feels lighter than "Normal".
Normal (Normal)	Specifies normal sensitivity.
Heavy (Heavy1)	Makes production of a louder sound more difficult, so touch feels heavier than "Normal".
Heavy (Heavy2)	Makes production of a louder sound more difficult, so touch feels heavier than "Normal".

- When the setting you want is selected, hold down **[F6]** EXIT until "[FUNCTION]" disappears from the display.

Changing the Pitch in Semitone Steps (Transpose)

Transpose lets you raise or lower the overall pitch of the Digital Piano in semitone steps. You can use this feature to raise or lower the keyboard key and to play a piece in a key that is more comfortable for you, or to adjust to a key that better matches a vocalist, etc.

To change the transpose setting

- Use the **[F5]** button to cycle through settings until the "V CTRL" indicator to the right of the button is lit. The currently selected transpose setting value will be shown on the display.
 
- Use the **[F0]** - and **[F1]** + buttons to change the setting.
 - You can change the pitch of the keyboard within the range of -12 to +12 semitones.

Using the Sound Mode Effects (Hall Simulator/Reverb and Surround)

You can use **[F8]** SOUND MODE to enable and disable the effects described below.

Hall Simulator/Reverb

Hall Simulator and Reverb are both effects that change the reverberation of the sound.

Hall Simulator: The hall simulator effect simulates the rich clarity, unconstrained brilliance, and other distinctive acoustic characteristics of world-famous concert halls and structures.

Reverb: Reverb simulates ambient spaces, such as a room or hall.

Surround

The Surround effect creates acoustics that make the sound from the speakers seem like it is coming from multiple directions (virtual surround). This effect is great when outputting audio from an external source through the Digital Piano's speakers.

To enable or disable the Hall Simulator/Reverb and Surround effects

- Touch **[F8]** SOUND MODE.
 - Each touch will cycle between the settings, and the current setting is indicated by the LED lights as shown below.

SOUND MODE	SOUND MODE	SOUND MODE
==	==	==
Hall Simulator/Reverb enabled Surround disabled (initial default)	Hall Simulator/Reverb enabled Surround enabled	Hall Simulator/Reverb disabled Surround disabled

To specify the Hall Simulator/Reverb type

- Hold down **[F8]** SOUND MODE until "[SOUND MODE]" appears on the display, and then release the button.
- After confirming that "Hall/Rev. Type" is displayed, touch **[F2]** ENTER.
- Use the **[F0]** - and **[F1]** + buttons to select the hall simulator/reverb type.

Hall Simulator

Type (displayed)	Description
1. N.Y.Club	Manhattan music club
2. Opera Hall	Uniquely shaped Sydney Concert Hall
3. Berlin Hall	Berlin arena type classic concert hall
4. BritishStadium	Large outdoor stadium in the London suburbs

Reverb

Type (displayed)	Description
5. Room 1	
6. Room 2	Simulates the reverberation of a room.
7. Room 3	
8. Large Room	
9. Hall 1	
10. Hall 2	Simulates the reverberation of a small hall.
11. Hall 3	
12. Stadium	Simulates the reverberation of a stadium.

- After the setting is the way you want, touch **[F6]** EXIT as many times as required until "[SOUND MODE]" disappears from the display.

To specify the Surround type

- Hold down **[F8]** SOUND MODE until "[SOUND MODE]" appears on the display, and then release the button.
- Use the **[F0]** < and **[F1]** > buttons to display "Surround Type" and then touch **[F2]** ENTER.
- Use the **[F0]** - and **[F1]** + buttons to select the surround type (Type 1 or Type 2).
- After the setting is the way you want, touch **[F6]** EXIT as many times as required until "[SOUND MODE]" disappears from the display.

Using the Knobs

The digital piano has two knobs that you can use to change the tone, effect, and another parameter settings in real time.

To select the functions (knob sets) assigned to the knobs

- Use the **[F5]** button to cycle through settings until the "V CTRL" indicator to the right of the button is lit.
- Touch **[F8]** KNOB. The name of the currently selected knob set will be shown on the display.



- Use the **[F0]** - and **[F1]** + buttons to select a knob set.
 - For information about parameters assigned to **[K1]** Knob (K1) and Knob (K2) by each knob set, refer to the User's Guide that is available from the CASIO website.

Using the Pitch Bend Wheel

You can use the pitch bend wheel to slide the pitch of notes smoothly upwards and downwards. This capability makes it possible to reproduce saxophone and electric guitar choking effects.

- While playing a note on the keyboard, rotate the **[F2]** PITCH BEND wheel on the left of the keyboard upwards or downwards.

The amount the note bends depends on how much you rotate the pitch bend wheel.

- Do not touch the wheel as you turn on the keyboard.

Using the Arpeggiator

With the arpeggiator, you can play various arpeggios and other phrases automatically by simply pressing keys on the keyboard. You can select from a number of different arpeggio options, including playing arpeggios from a chord, playing various phrases automatically, and more.

To enable the arpeggiator

IMPORTANT

- If "AH" appears instead of "AR" when you touch the **[F8]** ARPEG. button in step 2 of the procedure below, you will need to change the function assigned to the **[F8]** ARPEG. button. To do so, perform the following FUNCTION parameter operation: "ARPEG./A.HARMO." → "Type Select" → "Arpeggiator". For information about FUNCTION parameters, see "Configuring Function Settings (FUNCTION Mode)" (page 4/4).

- Use the **[F5]** button to cycle through settings until the "V CTRL" indicator to the right of the button is lit.
- To enable the arpeggiator, touch **[F8]** ARPEG. This will cause "AR" to appear on the display.



- Playing a chord or single note on the keyboard will play back the currently selected arpeggio.
- To disable the arpeggiator, touch **[F8]** ARPEG. This will cause "AR" to disappear from the display.

NOTE

- For information about how to select the arpeggiator type, refer to the User's Guide that is available from the CASIO Website. For details about arpeggiator types, refer to the separate "Built-in Music Data Lists".

Using Auto Accompaniment

After you select a rhythm type, Auto Accompaniment automatically plays realistic accompaniments to match chords you play.

Playing Accompaniment

The Auto Accompaniments of this Digital Piano consist of a "rhythm part" (drums and percussion) and a "chord part" (various musical instruments). When playing an Auto Accompaniment, you can sound the rhythm part only, or you can sound both parts at the same time.

To select a rhythm

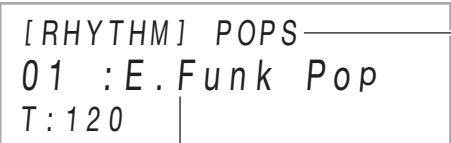
- Use the **[F5]** button to cycle through settings until the "V RHYTHM" indicator to the right of the button is lit. The names of the currently selected rhythm category and rhythm will be shown on the display.
 

- Use RHYTHM category buttons **[F6]** through **[F9]** to select a RHYTHM category.
- Use the **[F0]** - and **[F1]** + buttons to select a rhythm.

To play the rhythm part only

- Use the **[F3]** mode selector button to cycle through settings until the "RHYTHM" (RHYTHM Mode) indicator is lit.
- Use the procedure under "To select a rhythm" to select the rhythm you want.
- Touch **[F3]** START/STOP. This starts rhythm play.
 - The yellow and red LEDs above the **[F3]** START/STOP button will flash in time with the rhythm (yellow for beat 1, red for the remaining beats of each measure).
- Play along with the rhythm.
- To stop rhythm play, touch **[F3]** START/STOP again.

To play Auto Accompaniment with chords

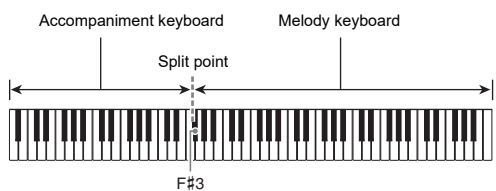
- Use the **[F3]** mode selector button to cycle through settings until the "ACCOMP" (ACCOMP Mode) indicator is lit.
- Start play of the rhythm part.
 - For information about how to select a rhythm and start playing it, see steps 2 and 3 under "To play the rhythm part only".
- Use the accompaniment keyboard to play chords. This will cause bass and harmony Auto Accompaniment parts to be added to the rhythm part.
 

Example:
Pressing D-F#-A-C on the accompaniment keyboard.
↓
Accompaniment for the D-F#-A-C chord (D7) sounds.

- Play other chords with left hand as you play the melody with your right hand.
 - You can use "CASIO Chord" or other simplified chord input modes to play chords. See "To select a chord input mode".
- To stop Auto Accompaniment, touch **[F3]** START/STOP.

To adjust the tempo

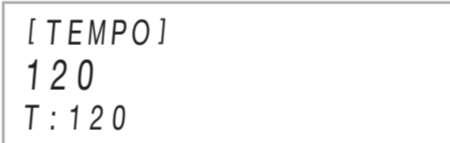
- Touch **[F2]** TEMPO. The current tempo value will be shown on the display.
 
- Use the **[F0]** - and **[F1]** + buttons to adjust the tempo value.
 - You can specify a tempo value in the range of 20 to 255.
- To exit the setting screen, touch **[F2]** TEMPO or **[F6]** EXIT.

To select a chord input mode

- Hold down the **[F5]** button until "[FUNCTION]" appears on the display. This enters the FUNCTION mode.
- Use the **[F0]** < and **[F1]** > buttons to display "ACCOMPANIMENT" and then touch **[F2]** ENTER.
- After confirming that "Chord Mode" is displayed, touch **[F2]** ENTER.
- Use the **[F0]** - and **[F1]** + buttons, or **[F2]** Knob (K1) to change the setting.

This setting (displayed):	Selects this chord input mode:
1. CASIO Chord	CASIO CHORD
2. Fingered 1	FINGERED 1
3. Fingered 2	FINGERED 2
4. Fg On Bass	FINGERED ON BASS
5. Fg Assist	FINGERED ASSIST
6. Full Range	FULL RANGE CHORD

- For information about input keyboard fingerings for the chord input mode you are using, refer to the User's Guide that is available from the CASIO Website.

- To exit the FUNCTION Mode, hold down **[F6]** EXIT until "[FUNCTION]" disappears from the display.

Metronome Accompaniment Patterns

The accompaniment patterns below produce metronome sounds only, without a bass or chord part. This is true even if you finger a chord.

This rhythm number:	Selects this metronome sound:
BALLAD: 39	Sounds a click for all beats.
BALLAD: 40	Sounds a bell for all beats.
BALLAD: 41 to 48	Two beats to nine beats per measure. The first beat of each measure is a bell sound, while the remaining beats are clicks.

Auto Accompaniment Pattern Variations

Generally, the progress of a musical piece starts with an intro, transitions to verses that are interspersed with interludes and other changes, and then returns to the main theme before reaching an ending. The Digital Piano's Auto Accompaniment function provides a selection of accompaniment patterns that are suited to the progress of a musical composition.

Normal and Variation

This is an accompaniment pattern that can be used in the verse or chorus of a piece. A variation repeats anywhere from one measure to multiple measures.

To play this accompaniment pattern:	Do this:
Normal	Touch [F3] NORMAL/FILL-IN.
Variation	Touch [F3] VARIATION/FILL-IN.

Fill-in

These accompaniment patterns are used to insert short one- or two-measure fill-ins into a piece. A fill-in pattern starts to play as soon as you touch one of the fill-in buttons (see below). Accompaniment play returns to the original normal or variation pattern from beat one after the one- or two-measure fill-in is complete.

To play this accompaniment pattern:	Do this:
Normal Fill-in	While a normal pattern is playing, touch [F3] NORMAL/FILL-IN.
Variation Fill-in	While a variation pattern is playing, touch [F3] VARIATION/FILL-IN.

Intro

This is an accompaniment pattern that can be used at the beginning of a song. Normal accompaniment pattern play will start after the measures of the intro accompaniment pattern is complete.

To play this accompaniment pattern:	Do this:
Intro	Touch [F3] INTRO.

Ending

This is an accompaniment pattern that can be used at the end of a piece. After a multiple-measure ending sounds, Auto Accompaniment ends.

To play this accompaniment pattern:	Do this:
Ending	While an Auto Accompaniment is playing, touch [F3] SYNCHRO/ENDING.

Triggering Auto Accompaniment Play with Accompaniment Keyboard Input (Synchro Start)

Use the procedure below to configure the Digital Piano to start Auto Accompaniment play as soon as you press a keyboard key.

To trigger Auto Accompaniment play with chord keyboard input

- While Auto Accompaniment play is stopped, touch **[F7]** SYNCHRO/ENDING. This enters synchro start standby, which is indicated by the LEDs above the **[F3]** START/STOP button flashing between yellow and red.
 - To exit synchro start standby at this point, touch **[F7]** SYNCHRO/ENDING.
- Finger a chord on the accompaniment keyboard. This starts Auto Accompaniment.

Splitting the Keyboard for Duet Play

You can split the keyboard in the center for duet play so the left and right sides have the same ranges. The Duet Mode is the perfect way to conduct lessons, with the teacher playing on the left side as the student plays the same song on the right side.

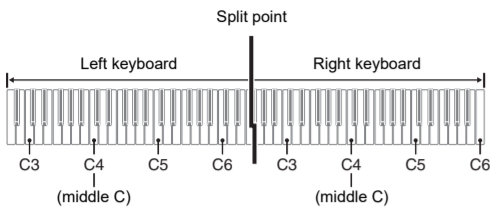

Pedal Operation when Playing a Duet

If you are using the separately available SP-34 Pedal Unit, the left outer pedal is the left keyboard damper pedal, while the right outer pedal is the right keyboard damper pedal. Only the damper pedal for the right keyboard supports half-pedal operations.

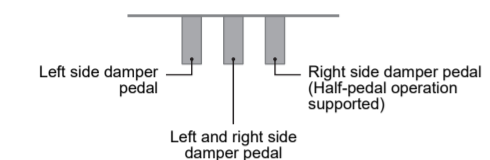

To use the supplied SP-3 Pedal as a damper pedal that affects both the left keyboard and right keyboard, connect it to the **7 DAMPER PEDAL** jack. Half-pedal operation is not supported in this case.

To use the Duet Mode

- Hold down the **F3** button until "[FUNCTION]" appears on the display. This enters the FUNCTION mode.
- Use the **F0** < and **F1** > buttons to display "KEYBOARD" and then touch **F2 ENTER**.
- Use the **F0** < and **F1** > buttons to display "DUET" and then touch **F2 ENTER**.
- After confirming that "Duet Mode" is displayed, touch **F2 ENTER**.
- Use the **F0** - and **F1** + buttons to change the Duet Mode setting.
 - To use the Duet Mode, select either "On" or "Pan" for this setting. To exit the Duet Mode and return to normal keyboard play, select "Off".

This setting (displayed):	Does this:
Off	Exits the Duet Mode.
On	Enters the Duet Mode.
Pan	Outputs left-side keyboard notes from the left speaker and right-side keyboard notes from the right speaker while in the Duet Mode.

- To exit the FUNCTION Mode, hold down **F5 EXIT** until "[FUNCTION]" disappears from the display.

Registering and Restoring a Setup (Registration)

You can use the registration function to register the setup of the Digital Piano (tone, rhythm, and other settings). You can recall a registered setup as required to perform a particular song, etc.

NOTE

- Registration operations can be performed in the RHYTHM Mode or ACCOMP Mode.
- Registration operations cannot be performed in the SONG Mode, or while demo play, music presets, or any setting operation is in progress.

Setup Storage Locations

Setup registrations are stored in memory locations that are divided into 24 banks. Each bank has four storage areas, which means you can register up to 96 setups (24 banks x 4 areas).

- Use the **F6 BANK** button to specify a bank.
- Specify an area using the **F7** Area 1 to **F0** Area 4 buttons.

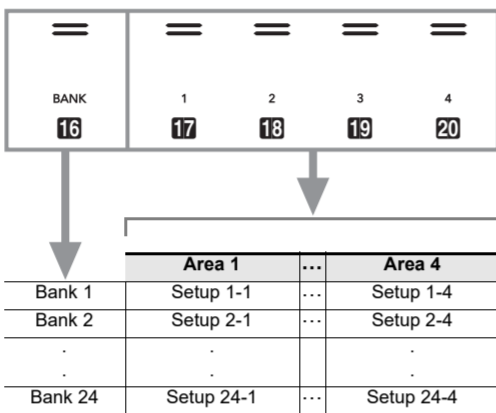

Registration Memory Setting Items

- Rhythm number, mode selection (ACCOMP Mode or RHYTHM Mode), synchro start standby, Auto Accompaniment settings (chord input mode, Auto Accompaniment volume)
- Tempo
- Tone numbers (Upper1, Upper2, Lower), Layer enable/disable, Split enable/disable, DSP (type, parameter), keyboard volume setting, part settings (volume, octave shift, fine tune), duet setting
- Split point
- Auto harmonize/arpeggiator (enable/disable, type, other settings)
- Transpose
- Scale settings (type, base note, Auto Accompaniment scale)
- Touch Response settings
- Chorus type, brilliance settings
- Hall simulator/reverb (enable/disable, type, depth, surround (enable/disable, type))
- Damper pedal function, expression/assignable pedal function, pitch bend range, part settings (Pedal Unit, damper pedal, expression/assignable pedal, pitch bend wheel)
- Knob settings

Saving to an External Device

Setups saved using registration can be saved to a USB flash drive in bank units. See "USB Flash Drive" (page 4/4).

Registering and Recalling a Setup

To register a setup

IMPORTANT

- Specifying a bank and area that already has data stored to it in the procedure below causes the recorded data to be deleted. For information about banks and areas, see "Setup Storage Locations".

- Use the **F3** mode selector button to cycle through settings until the "RHYTHM" or "ACCOMP" indicator is lit.
- Configure the Digital Piano with the setup you want to register.
- Use the **F3** button to cycle through settings until the "REG." indicator to the right of the button is lit.
- Select bank you want to use as the registration destination.

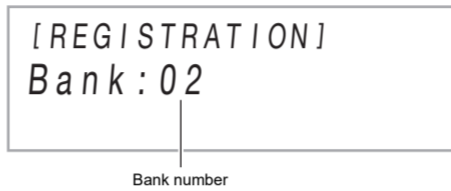

- Touch **F6 BANK** to cycle to the next bank number.
- Use the **F0** - and **F1** + buttons to select a bank number.

- Select the area where you want to store the setup. While holding down **F2 STORE**, touch an area button from **F7** Area 1 to **F0** Area 4.

This causes "Sure?" to appear on the display.

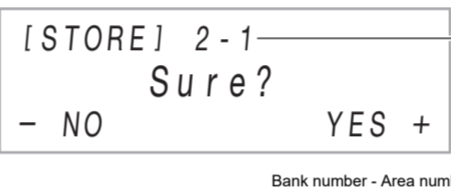

- To exit setup registration at this time, touch **F0** -.

- To register the setup, touch **F1** +. This completes the registration operation and displays "Complete".

To recall a registered setup

- Use the **F3** mode selector button to cycle through settings until the "RHYTHM" or "ACCOMP" indicator is lit.
- Use the **F3** button to cycle through settings until the "REG." indicator to the right of the button is lit.
- Use **F6 BANK**, or **F0** - and **F1** + to select the bank of the setup you want to recall. This recalls the setup.



- This causes the Digital Piano's settings to change in accordance with the setup you recalled.

Using the MIDI Recorder to Record Performances

The MIDI recorder records Digital Piano keyboard play as MIDI data. Recorded data is stored as SONG Mode song numbers 11 through 15.

- You can have up to five recorded songs in memory.
- Three-track multi-track recording is supported for each song.
- A maximum of approximately 30,000 notes (total for three tracks) can be recorded for each song.

IMPORTANT

- CASIO COMPUTER CO., LTD. takes no responsibility for any damages, lost profits, or claims by third parties arising from the deletion of recorded data due to malfunction, repair, or for any other reason.

Recorder Tracks and Recorded Data

The MIDI recorder of the Digital Piano is a three-track multi-track recorder.

Recorder track types are a system track and two solo tracks, and the data that can be recorded depends on the track type.

- System Track:** The system track can be used to record keyboard play using Auto Accompaniment. Layer, split, and other keyboard settings can also be recorded.
- Solo Track 1, Solo Track 2:** A solo track can be used to record keyboard play using a single tone (Upper1).

These tracks can be overdubbed as shown below.

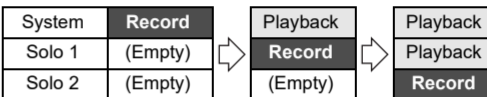

Saving to an External Device

After you create a recording with the Digital Piano, you can save the resulting data to a USB flash drive. See "USB Flash Drive" (page 4/4).

To record to the system track

- Configure the tone, rhythm, effects, tempo, and other settings you want to use during recording.
- Touch **F4 REC**. This enters record standby, indicated by **F4 REC** flashing red.
 - To cancel recording, touch **F4 REC** again.
 - If the MIDI recorder already has the maximum allowable number of songs recorded, the message "Data Full" will appear on the display, and the Digital Piano will exit record standby.
- To start recording, play something on the keyboard. This causes **F4 REC** to stop flashing and remain lit red, which indicates that recording is in progress.
 - Instead of playing on the keyboard, you could also start rhythm play and start recording by touching **F3 START/STOP**. In this case, only the rhythm is recorded until you play something on the keyboard.
- To stop recording, touch **F4 REC**.
 - This will automatically enter the SONG Mode, with what you just recorded selected for playback.
- To play back the song you just recorded, touch **F3** ► ■.

To overdub record a solo track over a recorded system track

NOTE

- If you are performing the procedure below immediately following the procedure under "To record to the system track", you do not need to enter the SONG Mode or select a song. Therefore, you should skip steps 1 and 2 below.

- Use the **F3** mode selector button to cycle through settings until the "SONG" (SONG Mode) indicator is lit.
- Use the **F0** - and **F1** + buttons to select the song number of a MIDI recorder song that was recorded to the system track.
 - Song numbers 11 through 15 are for songs recorded with the MIDI recorder. If necessary, you can touch **F3** ► ■ to play back the song and check its contents.
- Configure tone and other settings you want to use for recording.
- Touch **F4 REC**. This enters record standby, indicated by **F4 REC** flashing red.
- Hold down the **F4 REC** button until "[MIDI REC SETTING]" appears on the display.

- After confirming that "Rec Track" is displayed, touch **F2 ENTER**.



- Use the **F0** - and **F1** + buttons to select a track.
 - The display will show "Solo 1" or "Solo 2" depending on the solo track you select.
- To start recording, play something on the keyboard. This simultaneously starts playback of the system track and recording to the solo track you selected in step 7 above. This causes **F4 REC** to stop flashing and remain lit red, which indicates that recording is in progress.
 - Instead of playing on the keyboard, you could also start system track playback and solo track recording by touching **F3 START/STOP**. In this case, rests are inserted at the beginning of the solo track until you start playing something on the keyboard.
- To stop recording, touch **F4 REC**.
 - This will play back the contents of both the system track and the solo track.
 - If you want to overdub record the other solo track, perform steps 3 through 10 again, selecting the remaining (unrecorded) solo track in step 7.
- To play back the song you just recorded, touch **F3** ► ■.
- To stop recording, touch **F4 REC**.
- To play back the song you just recorded, touch **F3** ► ■.

Deleting a MIDI Recorder Song

- Use the **F3** mode selector button to cycle through settings until the "SONG" (SONG Mode) indicator is lit.
- Use the **F0** - and **F1** + buttons to select the song number of the MIDI recorder song you want to delete.
 - Song numbers 11 through 15 are for songs recorded with the MIDI recorder. If necessary, you can touch **F3** ► ■ to play back the song and check its contents.
- Hold down the **F4 REC** button until "Song Clear" appears on the display.
- Touch **F2 ENTER**. This causes "Sure?" to appear on the display.
- To delete the song, touch **F1** +. To exit this operation without deleting anything, touch **F0** -.

Using the Audio Recorder to Record Performances

The audio recorder records Digital Piano keyboard play as audio data. Recordings are stored as WAV files (linear PCM, 16bit, 44.1kHz, stereo) to the USB flash drive in the Digital Piano's USB flash drive port.

IMPORTANT

- Use a USB flash drive that is formatted as FAT32 or exFAT.
- Never remove the USB flash drive while Audio Recorder recording or playback is in progress. Doing so can corrupt the data on the USB flash drive and damage the USB flash drive port.

For precautions when handling a USB flash drive, see "USB Flash Drive" (page 4/4).

To prepare to use the audio recorder

- Perform the steps below to put the Digital Piano into the Audio Mode.
 - Hold down the **F3** button until "[FUNCTION]" appears on the display, and then release the button. This enters the FUNCTION mode.
 - Use the **F0** < and **F1** > buttons to display "SONG" and then touch **F2 ENTER**.
 - After confirming that "Song Type" is displayed, touch **F2 ENTER**.
 - Use the **F0** - and **F1** + buttons to change the setting to "Audio".
 - To exit the FUNCTION Mode, hold down **F5 EXIT** until "[FUNCTION]" disappears from the display.
- Insert the USB flash drive into the Digital Piano's **USB** flash drive port.

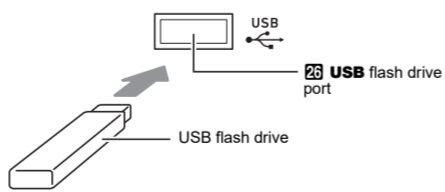

- Carefully push the USB flash drive in as far as it will go. Do not use undue force when inserting the USB flash drive.
- When the Digital Piano detects the USB flash drive, the message "MOUNTING" will appear on the display. Do not perform any operation while this message is displayed. Wait until it disappears.

To record a keyboard performance onto a USB flash drive

- Perform the procedure under "To prepare to use the audio recorder".
- Touch **F4 REC**. This enters record standby, indicated by **F4 REC** flashing red. The Digital Piano will enter the RHYTHM Mode at this time if it is in the SONG Mode.
 - To cancel recording, touch **F4 REC** again.
- To start recording, play something on the keyboard. This causes **F4 REC** to stop flashing and remain lit red, which indicates that recording is in progress.
 - Instead of playing on the keyboard, you could also start rhythm play and start recording by touching **F3 START/STOP**.
- To stop recording, touch **F4 REC**.
 - This will store the recording as a WAV file to the USB flash drive.
 - The Digital Piano will automatically switch to the SONG Mode with the file it just stored selected for playback.
- To play back the song you just recorded, touch **F3** ► ■.

To select and playback a file recorded with the audio recorder

- Perform the procedure under "To prepare to use the audio recorder".
- Use the **F3** mode selector button to cycle through settings until the "SONG" (SONG Mode) indicator is lit.
- Use the **F0** - and **F1** + buttons to select the file you want to play.
- To start playback, touch **F3** ► ■.
 - Playback stops automatically when the end of the file is reached. To stop playback part way through, touch **F3** ► ■.

Listening to Songs (MIDI Player)

Your Digital Piano has a MIDI player that can play back the MIDI file types described below.

Song Type	Description
User songs	You can add up to 10 songs to Digital Piano memory as user songs (Song Number 1 through 10). To add user song data (up to 320 KB per song of data that is playable by this Digital Piano), store it on a USB drive or smart device and then transfer the song data to Digital Piano memory. For details, see "USB Flash Drive" (page 4/4) and "Linking with a Smart Device (APP Function)" (page 4/4).
MIDI recorder songs	Songs recorded with the Digital Piano's MIDI recorder. See "Using the MIDI Recorder to Record Performances" (this page).
USB memory songs	Standard MIDI files (SMF format 0/1) or CASIO MIDI files (CMF format) stored on a USB flash drive. For information about how to store song data, see "Using a Computer to Copy General Song Data to a USB Flash Drive" (page 4/4).

To select and play back a song

- To play to play a song stored on a USB flash drive, insert the drive into the Digital Piano's **USB** flash drive port.
- Use the **F3** mode selector button to cycle through settings until the "SONG" (SONG Mode) indicator is lit.
- Use the **F0** - and **F1** + buttons to select a song number.

Song Number	Song Type
1 to 10	User songs
11 to 15	MIDI recorder songs
16 to 999	USB memory songs

 - Selecting some songs will initially cause "LOADING" to be displayed. This indicates that data is being loaded.
- To start playback of the selected song, touch **F3** ► ■.
 - The yellow and red LEDs above the **F3** ► ■ button will flash in time with the beat (yellow for beat 1, red for the remaining beats of each measure).
 - The operations below can be performed while playback is in progress.

To do this:	Perform this operation:
Stop playback	Touch F3 ► ■.
Pause playback	Touch F7 ■.
Change playback tempo (speed).	See "To adjust the tempo" (page 2/4).
Skip forward one measure.	Touch F6 ►►.
Fast forward	Hold down F6 ►►.
Skip back one measure.	Touch F6 ◀◀.
Fast backward	Hold down F6 ◀◀.

Recording and Playing Back Keyboard Play

IMPORTANT

- When the remaining recordable note count is 100 or lower during recording, the **F4 REC** button will flash. The **F4 REC** button light will stop flashing and turn off when the remaining recordable note count becomes zero.
- Should power fail during recording, all of the data in the track you are recording will be deleted.

Getting Ready to Use the MIDI Recorder

Your Digital Piano has two recorders: a MIDI recorder and an audio recorder. The MIDI recorder can be used while the Digital Piano is in the MIDI Mode. If the Digital Piano is in the Audio Mode, perform the procedure below to switch to the MIDI Mode. Note that the Digital Piano is in the MIDI Mode under initial default settings, so the operation below is not necessary if you have not changed the setting.

- Hold down the **F3** button until "[FUNCTION]" appears on the display. This enters the FUNCTION mode.
- Use the **F0** < and **F1** > buttons to display "SONG" and then touch **F2 ENTER**.
- After confirming that "Song Type" is displayed, touch **F2 ENTER**.
- Use the **F0** - and **F1** + buttons to change the setting to "MIDI".
- To exit the FUNCTION Mode, hold down **F5 EXIT** until "[FUNCTION]" disappears from the display.

To play a song with one of hand parts muted (for practice of the muted part)

NOTE

- This procedure can be used for a user song or a song on a USB flash drive.

- Perform steps 1 and 2 under "To select and play back a song".
- If you want, you could use the procedure under "To adjust the tempo" (page 2/4) to specify the tempo.
- Use the **F4 PART** button to select the part you want to mute.
 - Each touch of **F4 PART** cycles through the playback part settings. The currently selected playback part(s) is indicated by the "L" and "R" indicators that appear in the bottom center of the display.

This indicator	Means this:
LR	Both the left- and right-hand parts play.
L	Just the left-hand part plays, with the right-hand part muted.
R	Just the right-hand part plays, with the left-hand part muted.
	Both the left- and right-hand parts muted.

- To start playback, touch **F3** ► ■.
 - Play the muted part along with the playback.

NOTE

- When playing back a standard MIDI file (SMF format) stored on a USB flash drive, channel 3 will be assigned to the left-hand part while channel 4 will be assigned to the right-hand part.

Configuring Function Settings (FUNCTION Mode)

The FUNCTION Mode makes it possible to configure function settings using a menu format. There are two types of menu items: directories and parameters.

Directory: A directory is a group of multiple parameters.

Parameter: A parameter is an actual configurable setting. After you select the "Touch Response" parameter, for example, you can change its setting as desired.

The table below shows a representative example of some menu items provided in the FUNCTION Mode. Items marked "(DIR)" in the table are directories, while all of the other items are parameters.

Parameter Name or Directory Name	Display	Settings
Sound (DIR)	SOUND	—
Acoustic Simulator (DIR)	ACOUSTIC SIMU.	—
String Resonance	String Reso.	Tone, Off, 1 - 4
Damper Resonance	Damper Reso.	Tone, Off, 1 - 4
Damper Noise	Damper Noise	Tone, Off, 1 - 4
Key On Action Noise	Key On Noise	Tone, Off, 1 - 4
Key Off Action Noise	Key Off Noise	Tone, Off, 1 - 4
Effect (DIR)	EFFECT	—
Chorus Type	Chorus Type	Tone, 1 - 12
Brilliance	Brilliance	-3 - +3
Keyboard (DIR)	KEYBOARD	—
Touch Response	Touch Response	Off, Light2, Light1, Normal, Heavy1, Heavy2
Keyboard Volume	Keyboard Volume	0 - 127
Part Volume (DIR)	PART VOLUME	—
Upper1 Part	Upper1 Part	0 - 127
Upper2 Part	Upper2 Part	0 - 127
Lower Part	Lower Part	0 - 127
Part Octave Shift (DIR)	PART OCT SHIFT	—
Upper1 Part	Upper1 Part	-2, -1, 0, +1, +2
:	:	:

For a list of all the directories and parameters included in the FUNCTION Mode, refer to the User's Guide that is available from the CASIO Website.

■ To change FUNCTION parameter settings

1. Hold down the **[F]** button until "FUNCTION" appears on the display.

This enters the FUNCTION Mode and displays its top menu.

- The FUNCTION Mode top menu screen shows "FUNCTION" in the top line, and the name of the currently selected directory in line 2. Directory names are all-caps.

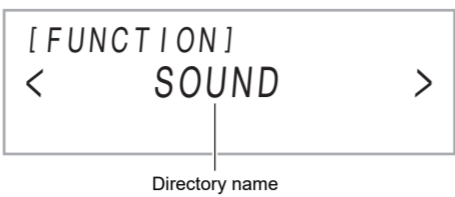

2. Display the name of the parameter whose setting you want to change.

- For example, to display the "Chorus Type" parameter, you need to navigate through multiple directories in the following sequence: "SOUND" (directory) → "EFFECT" (directory) → "Chorus Type" (parameter). Perform the procedure below.

- (1) Use the **[F]** < and **[R]** > buttons to display "SOUND" and then touch **[ENTER]**.

- This enters the "SOUND" directory.

- (2) Use the **[F]** < and **[R]** > buttons to display "EFFECT" and then touch **[ENTER]**.

- This enters the "EFFECT" directory.

- (3) Use the **[F]** < and **[R]** > buttons to display "Chorus Type".

- To exit the current directory and return to the level above it, touch **[EXIT]**.

3. After displaying the parameter name, touch **[ENTER]**.

This displays the parameter setting editing screen, with the parameter's current setting shown in line 3.

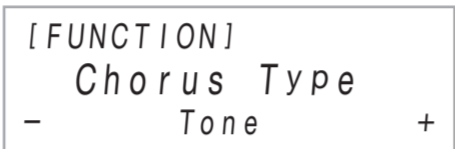

4. Use the **[F]** - and **[R]** + buttons, or **[K1]** Knob (K1) to change the setting.
5. After the setting is the way you want, exit the parameter editing screen by touching **[EXIT]**.
6. To exit the FUNCTION Mode, hold down **[EXIT]** until "FUNCTION" disappears from the display.

USB Flash Drive

Your Digital Piano supports the use of a commercially available USB flash drive to perform the operations below.

Playing Back Song Data from a USB Flash Drive

Standard song data (MIDI files) that has been stored on a USB flash drive with a computer can be played on your Digital Piano.

- For information about how to store song data on a USB flash drive, see "Using a Computer to Copy General Song Data to a USB Flash Drive".
- For information about the song data playback operation, see "Listening to Songs (MIDI Player)" (page 3/4).

Recording a Performance to a USB Flash Drive

See "Using the Audio Recorder to Record Performances" (page 3/4) for information about how to record audio data produced by performances on your Digital Piano to a USB flash drive.

Saving and Importing Data

Data recorded with your Digital Piano (MIDI recorder songs, registration setups, etc.) can be stored on a USB flash drive. Data that has been stored with the Digital Piano, as well as other data that is supported by the Digital Piano (user songs, etc.) can be imported from a USB flash drive. For details, refer to the User's Guide that is available from the CASIO Website.

USB Flash Drive and USB Flash Drive Port Handling Precautions

IMPORTANT!

- Be sure to observe the precautions provided in the documentation that comes with the USB flash drive.
- Avoid using a USB flash drive under the conditions below. Such conditions can corrupt data stored on the USB flash drive.
 - Areas subjected to high temperature, high humidity, or corrosive gas
 - Areas subjected to strong electrostatic charge and digital noise
- Never remove the USB flash drive while data is being written to or loaded from it. Doing so can corrupt the data on the USB flash drive and damage the USB flash drive port.
- Never insert anything besides a USB flash drive into the USB flash drive port. Doing so creates the risk of malfunction.
- A USB flash drive can become warm after very long use. This is normal and does not indicate malfunction.
- Static electricity conducted to the USB flash drive port from your hand or from a USB flash drive can cause malfunction of the Digital Piano. If this happens, turn the Digital Piano off and then back on again.

Using the Digital Piano as a Bluetooth Speaker System

This Digital Piano can be used as a Bluetooth speaker system. After you pair the Digital Piano with an external device that is Bluetooth audio capable, you can output playback from the external device through the Digital Piano's speakers.

IMPORTANT!

- Before performing the pairing operation, turn down the volume levels of the Digital Piano and the external device.
- If external device notes that sound through the Digital Piano speakers are distorted, lower the external device's volume level setting.

■ To pair the Digital Piano with a Bluetooth audio device

1. Hold down the **[F]** button until "FUNCTION" appears on the display.

This enters the FUNCTION Mode.
2. Use the **[F]** < and **[R]** > buttons to display "AUDIO IN" and then touch **[ENTER]**.
3. Use the **[F]** < and **[R]** > buttons to display "BLUETOOTH" and then touch **[ENTER]**.
4. Use the **[F]** < and **[R]** > buttons to display "Pairing" and then touch **[ENTER]**.

This causes the Digital Piano's Bluetooth icon (📶) to flash, which indicates pairing standby.

 - If the Digital Piano's Bluetooth is turned off, it will turn on automatically at this point.
5. On the Bluetooth setting screen that appears on the external device, turn on Bluetooth if it is off.
6. On the Bluetooth setting screen on the external device, select "CASIO Privia" (this Digital Piano).
 - This completes pairing, which causes the Digital Piano's Bluetooth icon (📶) to change from flashing to lit.
 - Now output from the external device will sound from the Digital Piano's speakers.
7. To exit the FUNCTION mode, hold down **[EXIT]** until "FUNCTION" disappears from the display.

NOTE

- You need to perform the above procedure only once for a device. After that, turning on the Digital Piano's and the device's Bluetooth will cause them to connect automatically.
- The Digital Piano can store pairing information for up to eight Bluetooth audio devices. Note, however, that only one device can be connected to the Digital Piano at a time.

Product Specifications

Model: PX-S3000BK

Keyboard: 88-key piano keyboard; Duet: Adjustable tone range (-2 to +2 octaves); Transpose: -12 to 0 to +12 semitones; Octave shift: -2 to 0 to +2 octaves

Sound Source: Number of Tones: 700; Layer; Split; Maximum polyphony: 192 notes; Touch Response (5 sensitivity levels, Off); Tuning: 415.5Hz to 440.0Hz to 465.9Hz (0.1Hz units); Temperament: Equal temperament plus 16 other types

Acoustic Simulator: Hammer response, Key off response, String resonance, Damper resonance, Damper noise, Key on action noise, Key off action noise

Sound Mode: Hall simulator (4 types), Reverb (8 types), Surround (2 types)

Other Effects: Chorus (12 types), DSP (built in to some tones + 100 presets, editable), Brilliance (-3 to 0 to 3)

Demo Song: 6

Playback Function (SONG Mode): In the MIDI Mode: Downloaded (user) song playback: storage of up to 10 songs in built-in flash memory (Up to approximately 320KB* per song); MIDI recorder song playback; USB flash drive song data (SMF) playback; part mute: L, R, L+R

* Based on 1KB = 1024 bytes, 1MB = 1024² bytes

In the Audio Mode: Audio recorder recording and playback, center cancel

Song Volume: Adjustable (for both MIDI Mode, Audio Mode)

MIDI Recorder: Real-time recording and playback as MIDI data; Number of Songs: 5; Number of Tracks: 3; Capacity: Approximately 30,000 notes per song (total of three tracks); Data storage: Built-in flash memory

Audio Recorder: Real-time recording and playback as audio data; Number of songs: 99 (files); File format: WAV (linear PCM, 16bit, 44.1kHz, stereo); Maximum recording time: Approximately 25 minutes per file; Recording medium: USB Flash Drive

Auto Accompaniment: Built-in Rhythms: 200; One Touch Preset: 200; Auto Harmonize: 12 types; Auto Accompaniment Volume Level: Adjustable

Music Preset: 310

Arpeggiator: 100 types

Metronome: Provided as rhythm type; Beat bell: Off, 1 to 9 (beats); Tempo Range: 20 to 255; Metronome Volume Level: Adjustable (as Auto Accompaniment volume level)

Registration Function: 96 sets maximum (4 sets, 24 banks)

Pedals: With provided pedal (SP-3); Switchable between sustain (off, on), sostenuto (off, on), soft (off, on), arpeggio hold (off, on), play/stop, and fill-in; With Pedal Unit (separately available SP-34); Sustain (off, half, on), sostenuto (off, on), soft (off, on); expression pedal support

Other Functions: Auto Resume, Operation Lock

Bluetooth Connection: Bluetooth Version: 5.0; Supported Profile: A2DP; Supported Codecs: SBC; Wireless Output: Bluetooth Class 2; Transmission Frequency Range: 2402 to 2480 MHz; Maximum Wireless Output: 4dBm

MIDI: 16-channel multi-timbre receive

Pitch Bend Wheel: Pitch bend range: 0 to 24 semitones
Knobs: 2; Knob sets (knob function presets): 14

Inputs/Outputs: PHONES jacks: Stereo mini jacks (3.5mm) × 2; Power: 12V DC; AUDIO IN jack: Stereo mini jack (3.5mm) (Input impedance: 10kΩ, Input voltage: 200mV); LINE OUT R, L/MONO jacks: Standard jacks (6.3mm) × 2 (Output impedance: 2.3kΩ, Output voltage: 1.3V (RMS) MAX); USB port: Type B; USB flash drive port: Type A;

DAMPER PEDAL jack: Standard jack (6.3mm); EXPRESSION/ASSIGNABLE jack: Standard jack (6.3mm); PEDAL UNIT jack; Proprietary jack

Acoustics: Amp output: 8W + 8W; Speakers: 16cm × 8cm (oval) × 2

Power Supply: 2-way
Batteries: 6 AA-size alkaline batteries
Continuous Operation: Approximately 2 hours

Playback of built-in demo tunes on alkaline batteries
Actual continuous operation time may be shorter due to battery type and performance type.

AC Adaptor: AD-A12150LW
Auto Power Off: Approximately four hours (under AC adaptor power) or six minutes (under battery power) after last operation, can be disabled.

Power Consumption: 12W --- 15W
Dimensions: 132.2 (W) × 23.2 (D) × 10.2 (H) cm (52 1/16 × 9 1/8 × 4 inch)

Weight: Approximately 11.4kg (25.1 lbs) (without batteries)

- Specifications and designs are subject to change without notice.

Operating Precautions

Be sure to read and observe the following operating precautions.

Location

Avoid the following locations for this product.

- Areas exposed to direct sunlight and high humidity
 - Areas subjected to temperature extremes
 - Near a radio, TV, video deck, or tuner
- The above devices will not cause malfunction of the product, but the product can cause interference in the audio or video of a nearby device.

User Maintenance

- Never use benzine, alcohol, thinner, or other chemical agents to clean the product.
- To clean the product or its keyboard, wipe with a soft cloth moistened in a weak solution of water and a mild neutral detergent. Wring all excess moisture from the cloth before wiping.

Included and Optional Accessories

Use only accessories that are specified for use with this product. Use of unauthorized accessories creates the risk of fire, electric shock, and personal injury.

Weld Lines

Lines may be visible on the exterior of the product. These are "weld lines" that result from the plastic molding process. They are not cracks or scratches.

Musical Instrument Etiquette

Always be aware of others around you whenever using this product. Be especially careful when playing late at night to keep the volume at levels that do not disturb others. Other steps you can take when playing late at night are closing the window and using headphones.

Copyrights

You are allowed to use recordings for your own personal use. Any reproduction of an audio or music format file, without the permission of its copyright holder, is strictly prohibited under copyright laws and international treaties. Also, making such files available on the Internet or distributing them to third parties, regardless of whether such activities are conducted with or without compensation, is strictly prohibited under copyright laws and international treaties. CASIO COMPUTER CO., LTD. shall not be held in any way liable for any use of this Digital Piano that is illegal under copyright laws.

Supported USB Flash Drives

This Digital Piano supports USB flash drives formatted to FAT32 or exFAT. If your USB flash drive is formatted to a different file system, use the Windows format function to reformat it to FAT32 or exFAT. Do not use quick format.

Connecting a USB Flash Drive to and Detaching it from the Digital Piano

To connect a USB flash drive

As shown in the illustration below, insert the USB flash drive into the Digital Piano's **[USB]** USB flash drive port.

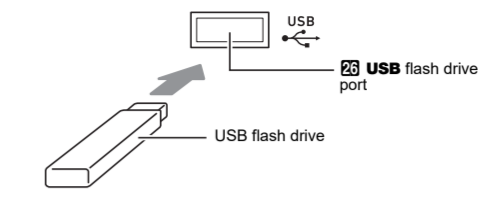

- Carefully push the USB flash drive in as far as it will go. Do not use undue force when inserting the USB flash drive.
- When the Digital Piano detects the USB flash drive, the message "MOUNTING" will appear on the display. Do not perform any operation while this message is displayed. Wait until it disappears.

To disconnect a USB flash drive

After checking to make sure that the message "MOUNTING" or "Wait" is not on the display (indicating a read or write operation being performed), pull the USB flash drive straight out of the USB flash drive port.

NOTE

- Mounting a USB flash drive on the Digital Piano will create a folder named MUSICDAT in the drive's root directory if a MUSICDAT folder does not already exist there. Use this folder when exchanging data between the Digital Piano and USB flash drive.

Using a Computer to Copy General Song Data to a USB Flash Drive

You can play back MIDI files of the formats below, which are stored in the MUSICDAT folder.

- Standard MIDI files (SMF format 0/1)
- CASIO MIDI files (CMF format)

1. Connect the USB flash drive to your computer.
2. Create a folder named MUSICDAT in the root directory of the USB flash drive.
 - This step is not required if there is already a MUSICDAT folder in the USB flash drive's root directory.
3. Copy song data you want to play back on the Digital Piano to the MUSICDAT folder.
 - For information about the song data playback operation, see "Listening to Songs (MIDI Player)" (page 3/4).

NOTICE

This equipment has been tested and found to comply with the limits for a Class B digital device, pursuant to Part 15 of the FCC Rules. These limits are designed to provide reasonable protection against harmful interference in a residential installation. This equipment generates, uses and can radiate radio frequency energy and, if not installed and used in accordance with the instructions, may cause harmful interference to radio communications. However, there is no guarantee that interference will not occur in a particular installation. If this equipment does cause harmful interference to radio or television reception, which can be determined by turning the equipment off and on, the user is encouraged to try to correct the interference by one or more of the following measures:

- Reorient or relocate the receiving antenna.
- Increase the separation between the equipment and receiver.
- Connect the equipment into an outlet on a circuit different from that to which the receiver is connected.
- Consult the dealer or an experienced radio/TV technician for help.

FCC CAUTION

Changes or modifications not expressly approved by the party responsible for compliance could void the user's authority to operate the equipment.

Declaration of Conformity

Model Number: PX-S3000
Trade Name: CASIO COMPUTER CO., LTD.
Responsible party: CASIO AMERICA, INC.
Address: 570 MT. PLEASANT AVENUE,
DOVER, NEW JERSEY 07801

Telephone number: 973-361-5400
This device complies with Part 15 of the FCC Rules. Operation is subject to the following two conditions:

- (1) This device may not cause harmful interference,
- (2) and (2) this device must accept any interference received, including interference that may cause undesired operation.

Important!

Please note the following important information before using this product.

- Before using the AD-A12150LW Adaptor to power the unit, be sure to check the AC Adaptor for any damage first. Carefully check the power cord for breakage, cuts, exposed wire and other serious damage. Never let children use an AC adaptor that is seriously damaged.
- The product is not intended for children under 3 years.
- Use only CASIO AD-A12150LW adaptor.
- The AC adaptor is not a toy.
- Be sure to disconnect the AC adaptor before cleaning the product.

Linking with a Smart Device (APP Function)

You can use the APP Function to connect the Digital Piano with a phone, tablet or other smart device and perform the operations described below.

- Control the Digital Piano from a smart device (Piano Remote Controller)
- Transfer music data from a smart device

■ To download the smart device app

Download the Chordana Play for Piano app from the CASIO website and install it on the smart device.
<https://support.casio.com/global/en/eml/manual/PX-S300/>



■ To link to a smart device

After installing the Chordana Play for Piano app on a smart device, use a commercially available USB cable to connect the smart device's USB port with the Digital Piano's USB port.

After connecting the smart device to the Digital Piano, use the smart device app to perform operations. For details about operations, refer to the user documentation of the app.

Declaration of Conformity According to EU Directive

Manufacturer: CASIO COMPUTER CO., LTD.
6-2, Hon-machi 1-chome, Shibuya-ku, Tokyo 151-8543, Japan

Responsible within the European Union: Casio Europe GmbH
Casio-Platz 1, 22848 Norderstedt, Germany
www.casio-europe.com

Company and product names used in this manual may be registered trademarks of others.

This recycle mark indicates that the packaging conforms to the environmental protection legislation in Germany.

■ About the AC adaptor that comes with the Digital Piano

Note the following important precautions to avoid damage to the AC adaptor and power cord.

- Never pull on the cord with excessive force.
- Never repeatedly pull on the cord.
- Never twist the cord at the base of the plug or connector.
- Before moving the Digital Piano, be sure to unplug the AC adaptor from the power outlet.
- Loop and bundle the power cord, but never wind it around the AC adaptor.

Any reproduction of the contents of this manual, either in part or its entirety, is prohibited. Except for your own, personal use, any other use of the contents of this manual without the consent of CASIO is prohibited under copyright laws.

IN NO EVENT SHALL CASIO BE LIABLE FOR ANY DAMAGES WHATSOEVER (INCLUDING, WITHOUT LIMITATION, DAMAGES FOR LOSS OF PROFITS, BUSINESS INTERRUPTION, LOSS OF INFORMATION) ARISING OUT OF THE USE OF OR INABILITY TO USE THIS MANUAL OR PRODUCT, EVEN IF CASIO HAS BEEN ADVISED OF THE POSSIBILITY OF SUCH DAMAGES.

The contents of this manual are subject to change without notice.

CASIO COMPUTER CO., LTD.

6-2, Hon-machi 1-chome

Shibuya-ku, Tokyo 151-8543, Japan

MA1905-C Printed in China

© 2019 CASIO COMPUTER CO., LTD.

A labels rating is affixed to the bottom of the product.