

CTK-720

USER'S GUIDE GUÍA DEL USUARIO



GUIDELINES LAID DOWN BY FCC RULES FOR USE OF THE UNIT IN THE U.S.A. (not applicable to other areas).

NOTICE

This equipment has been tested and found to comply with the limits for a Class B digital device, pursuant to Part 15 of the FCC Rules. These limits are designed to provide reasonable protection against harmful interference in a residential installation. This equipment generates, uses and can radiate radio frequency energy and, if not installed and used in accordance with the instructions, may cause harmful interference to radio communications. However, there is no guarantee that interference will not occur in a particular installation. If this equipment does cause harmful interference to radio or television reception, which can be determined by turning the equipment off and on, the user is encouraged to try to correct the interference by one or more of the following measures:

- Reorient or relocate the receiving antenna.
- Increase the separation between the equipment and receiver.
- Connect the equipment into an outlet on a circuit different from that to which the receiver is connected.
- Consult the dealer or an experienced radio/TV technician for help.

FCC WARNING

Changes or modifications not expressly approved by the party responsible for compliance could void the user's authority to operate the equipment.

Declaration of Conformity

Model Number: CTK-720

Trade Name: CASIO COMPUTER CO., LTD.

Responsible party: CASIO, INC.

Address: 570 MT. PLEASANT AVENUE, DOVER, NEW JERSEY 07801

Telephone number: 973-361-5400

This device complies with Part 15 of the FCC Rules, Operation is subject to the following two conditions:

(1) This device may not cause harmful interference, and (2) this device must accept any interference received, including interference that may cause undesired operation.

Important!

Please note the following important information before using this product.

- Before using the optional AD-5 Adaptor to power the unit, be sure to check the AC Adaptor for any damage first. Carefully check the power cord for breakage, cuts, exposed wire and other serious damage. Never let children use an AC adaptor that is seriously damaged.
- Never attempt to recharge batteries.
- Do not use rechargeable batteries.
- Never mix old batteries with new ones.
- Use recommended batteries or equivalent types.
- Always make sure that positive (+) and negative (-) poles are facing correctly as indicated near the battery compartment.
- Replace batteries as soon as possible after any sign they are getting weak.
- Do not short-circuit the battery terminals.
- The product is not intended for children under 3 years.
- Use only CASIO AD-5 adaptor.
- The AC adaptor is not a toy.
- Be sure to disconnect the AC adaptor before cleaning the product.



This mark applies in EU countries only.



CASIO Europe GmbH
Bornbarch 10, 22848 Norderstedt, Germany

Safety Precautions

Congratulations on your selection of the CASIO electronic musical instrument.

- Before using the instrument, be sure to carefully read through the instructions contained in this manual.
- Be sure to keep all user documentation handy for future reference.

Symbols

Various symbols are used in this user's guide and on the product itself to ensure that the product is used safely and correctly, and to prevent injury to the user and other persons as well as damage to property. Those symbols along with their meanings are shown below.

DANGER

This symbol indicates information that, if ignored or applied incorrectly, creates the danger of death or serious personal injury.

WARNING

This indication stipulates matters that have the risk of causing death or serious injury if the product is operated incorrectly while ignoring this indication.

CAUTION

This indication stipulates matters that have the risk of causing injury as well as matters for which there is the likelihood of occurrence of physical damage only if the product is operated incorrectly while ignoring this indication.

Symbol Examples



This triangle symbol (\triangle) means that the user should be careful. (The example at left indicates electrical shock caution.)



This circle with a line through it (\odot) means that the indicated action must not be performed. Indications within or nearby this symbol are specifically prohibited. (The example at left indicates that disassembly is prohibited.)



The black dot (\bullet) means that the indicated action must be performed. Indications within this symbol are actions that are specifically instructed to be performed. (The example at left indicates that the power plug must be unplugged from the electrical socket.)

DANGER

Alkaline Batteries

Perform the following steps immediately if fluid leaking from alkaline batteries ever gets into your eyes. 

1. Do not rub your eyes! Rinse them with water.
2. Contact your physician immediately. Leaving alkaline battery fluid in your eyes can lead to loss of sight.

WARNING



Smoke, Strange Odor, Overheating

Continued use of the product while it is emitting smoke, a strange odor, or heat creates the risk of fire and electric shock. Take the following steps immediately.



1. Turn off power.
2. If you are using the AC adaptor for power, unplug it from the wall outlet.
3. Contact your original retailer or an authorized CASIO Service Provider.



AC Adaptor

● Misuse of the AC adaptor creates the risk of fire and electric shock. Always make sure you observe the following precautions.

- Be sure to use only the AC adaptor that is specified for this product. 
- Use only a power source whose voltage is within the rating marked on the AC adaptor.
- Do not overload electrical outlets and extension cords. 

● Misuse of the AC adaptor's electric cord can damage or break it, creating the risk of fire and electric shock. Always make sure you observe the following precautions.

- Never place heavy objects on the cord or subject it to heat. 
- Never try to modify the cord or subject it to excessive bending.
- Never twist or stretch the cord.
- Should the electric cord or plug become damaged, contact your original retailer or authorized CASIO Service Provider. 

- Never touch the AC adaptor while your hands are wet. Doing so creates the risk of electric shock. 
- Use the AC adaptor where it will not be splashed with water. Water creates the risk of fire and electric shock. 
- Do not place a vase or any other container filled with liquid on top of the AC adaptor. Water creates the risk of fire and electric shock. 

Batteries

Misuse of batteries can cause them to leak, resulting in damage to nearby objects, or to explode, creating the risk of fire and personal injury. Always make sure you observe the following precautions.

- Never try to take batteries apart or allow them to become shorted. 
- Never expose batteries to heat or dispose of them by incineration.
- Never mix old batteries with new ones.
- Never mix batteries of different types.
- Do not charge the batteries.
- Make sure the positive (+) and negative (-) ends of the batteries are facing correctly.

Do not incinerate the product.

Never throw the product into fire. Doing so can cause it to explode, creating the risk of fire and personal injury. 

Water and Foreign Matter

Water, other liquids, and foreign matter (such as pieces of metal) getting into the product create the risk of fire and electric shock. Take the following steps immediately. 

1. Turn off power.
2. If you are using the AC adaptor for power, unplug it from the wall outlet.
3. Contact your original retailer or an authorized CASIO Service Provider.

Disassembly and Modification

Never try to take this product apart or modify it in any way. Doing so creates the risk of electric shock, burn injury, or other personal injury. Leave all internal inspection, adjustment, and maintenance up to your original retailer or authorized CASIO Service Provider. 



Dropping and Impact

Continued use of this product after it has been damaged by dropping or subjecting it to strong impact creates the risk of fire and electric shock. Take the following steps immediately.

1. Turn off power.
2. If you are using the AC adaptor for power, unplug it from the wall outlet. 
3. Contact your original retailer or an authorized CASIO Service Provider.

Plastic Bags

Never place the plastic bag the product comes in over your head or in your mouth. Doing so creates the risk of suffocation. Particular care concerning this precaution is required where small children are present. 

Keep off of the product and stand.*



Climbing onto the product or stand can cause it to tip over or become damaged. Particular care concerning this precaution is required where small children are present. 

Location

Avoid locating the product on an unstable stand, on an uneven surface, or any other unstable location. An unstable location can cause the product to fall over, creating the risk of personal injury. 

⚠ CAUTION

AC Adaptor

- Misuse of the AC adaptor creates the risk of fire and electric shock. Always make sure you observe the following precautions.
 - Do not locate the electric cord near a stove or other sources of heat. 
 - Never pull on the cord when unplugging from the electrical outlet. Always grasp the AC adaptor when unplugging.
- Misuse of the AC adaptor creates the risk of fire and electric shock. Always make sure you observe the following precautions.
 - Insert the AC adaptor into the wall outlet as far as it will go. 
 - Unplug the AC adaptor from the wall outlet during lightening storms or before leaving on a trip or other long-term absence.
 - At least once a year, unplug the AC adaptor from the wall outlet and wipe away any dust that is built up in the area around the prongs of the plug.

Relocating the Product

Before relocating the product, always unplug the AC adaptor from the wall outlet and disconnect all other cables and connecting cords. Leaving cords connected creates the risk of damage to the cords, fire, and electric shock. 

Cleaning

Before cleaning the product, always unplug the AC adaptor from the wall outlet first. Leaving the AC adaptor plugged in creates the risk of damage to the AC adaptor, fire, and electric shock. 

Batteries

Misuse of batteries can cause them to leak resulting in damage to nearby objects, or to explode, creating the risk of fire and personal injury. Always make sure you observe the following precautions.

- Use only batteries that are specified for use with this product.
- Remove batteries from the product if you do not plan to use it for a long time.

Connectors

Connect only the specified devices and equipment to the product's connectors. Connection of a non-specified device or equipment creates the risk of fire and electric shock.



Location

Avoid the following locations for this product. Such locations create the risk of fire and electric shock.



- Areas subject to high humidity or large amounts of dust.
- In food preparation areas or other areas subject to oil smoke.
- Near air conditioning equipment, on a heated carpet, in areas exposed to direct sunlight, inside of a vehicle parked in the sun, or any other area that subjects the product to high temperatures.

Display Screen

- Never push on the display screen's LCD panel or subject it to strong impact. Doing so can cause the LCD panel's glass to crack, creating the risk of personal injury.
- Should the LCD panel ever crack or break, never touch the liquid inside of the panel. LCD panel liquid can cause skin irritation.
- Should LCD panel liquid ever get inside your mouth, immediately wash out your mouth with water and contact your physician.
- Should LCD panel liquid ever get into your eyes or onto your skin, rinse with clear water for at least 15 minutes, and then contact a physician.



Sound Volume

Do not listen to music at very loud volumes for long periods. Particular care concerning this precaution is required when using headphones. High volume settings can damage your hearing.



Heavy Objects

Never place heavy object on top of the product.

Doing so can make the product top heavy, causing the product to tip over or the object to fall from it, creating the risk of personal injury.



Correct Stand* Assembly

An incorrectly assembled stand can tip over, causing the product to fall and creating the risk of personal injury.



Make sure you assemble the stand correctly, following the assembly instructions that come with it. Make sure you mount the product on the stand correctly.

* Stand is available as an option.

IMPORTANT!

When using batteries, be sure to replace them or shift to one of the alternate power sources whenever you notice any of the following symptoms.

- Dim power supply indicator
- Instrument does not turn on.
- Dim, difficult to read display
- Abnormally low speaker/headphone volume
- Distortion of sound output
- Occasional interruption of sound when playing at high volumes
- Sudden power failure when playing at high volumes
- Dimming of the display when playing at high volume
- Continued sound output even after you release a key
- A totally different tone may sound
- Abnormal rhythm pattern and demo tune play
- Abnormally low microphone volume
- Distortion of microphone input
- Dim power supply indicator when a microphone is used
- Sudden power failure when using the microphone

Company and product names used in this manual may be registered trademarks of others.



Introduction

Congratulations upon your selection of this CASIO musical instrument. This keyboard provides you with the following features and functions.

☐ 242 tones

Choose from among orchestral sounds, synthesized sounds, and more.

☐ 100 rhythms

100 versatile rhythms help to add plenty of life to all your keyboard performances.

☐ Auto Accompaniment

Simply play a chord and the corresponding rhythm, bass and chord parts play automatically.

☐ PIANO BANK button

The touch of a button takes you directly to piano tones and piano lessons.

☐ 3-Step Lesson System

The 3-Step Lesson System lets you practice at your own pace. The keyboard automatically grades your performances, so you can trace your progress as you improve.

- 3-Step Lesson System: Now you can learn the parts that make up the keyboard's built-in tunes. Guidance that appears on the monitor screen helps lead you down the path to music proficiency.
- Evaluation System: The keyboard can be configured to rate your performances during Step 3 lesson by assigning points.

☐ 100 built-in tunes, including piano pieces

Built-in tunes are divided into two groups: a Song Bank of 50 tunes with Auto Accompaniment, and a Piano Bank of 50 piano tunes.

☐ Musical Information System

A big LCD screen graphically shows you fingerings, keyboard keys to be pressed, and notes, making keyboard play more informative and enjoyable than ever before.



Care of your keyboard

Avoid heat, humidity or direct sunlight.

Do not overexpose the instrument to direct sunlight, or place it near an air conditioner, or in any extremely hot place.

Do not use near a TV or radio.

This instrument can cause video or audio interference with TV and radio reception. If this happens, move the instrument away from the TV or radio.

Do not use lacquer, thinner or similar chemicals for cleaning.

Clean the keyboard with a soft cloth dampened in a weak solution of water and a neutral detergent. Soak the cloth in the solution and squeeze until it is almost dry.

Avoid use in areas subjected to temperature extremes.

Extreme heat can cause figures on the LCD screen to become dim and difficult to read. This condition should correct itself when the keyboard is brought back to normal temperature.

NOTE

- You may notice lines in the finish of the case of this keyboard. These lines are a result of the molding process used to shape the plastic of the case. They are not cracks or breaks in the plastic, and are no cause for concern.
-



Contents

Safety Precautions E-1

Introduction E-5

Care of your keyboard E-5

General Guide E-8

Attachment of the Score Stand E-9

Quick Reference E-10

To play the keyboard E-10

Power Supply E-12

Using batteries E-12

Using the AC Adaptor E-13

Auto Power Off E-13

Settings E-13

Connections E-14

Phones/Output Terminal E-14

Connecting to a Computer or
Other Equipment E-14

Sustain jack Terminal E-14

Microphone Jack E-14

Accessories and Options E-14

Basic Operations E-15

Playing the Keyboard E-15

Selecting a Tone E-15

Using the Microphone Jack E-16

Auto Accompaniment E-17

Selecting a Rhythm E-17

Playing a Rhythm E-17

Adjusting the Tempo E-18

Using Auto Accompaniment E-18

Using a Fill-in Pattern E-20

Synchro Starting Accompaniment with
Rhythm Play E-20

Playing a Built-in Tune E-21

To play back a Song Bank tune E-21

To play back a Piano Bank tune E-22

Adjusting the Tempo E-22

To change the melody tone E-23

To play all tunes in succession E-23

Using the PIANO BANK Button E-23

3-Step Lesson E-24

Evaluation Mode E-25

Using the Lesson Functions and
Evaluation Mode E-25

Step 1 – Master the timing. E-25

Step 2 – Master the notes. E-26

Step 3 – Play at normal speed. E-26

Voice Fingering Guide E-27



Keyboard Settings E-28

- Adjusting Accompaniment and
Song Bank Volume E-28
- Transposing the Keyboard E-28
- Tuning the Keyboard E-29

Connection to a Computer E-30

- Connecting to a Computer E-30
- General MIDI Tone E-31
- Changing the Settings E-31

Troubleshooting E-33

Specifications E-34

Appendix A-1

- Tone List A-1
- Percussion Instrument List A-5
- Fingered Chord Chart A-6
- Rhythm List A-8
- Song List A-9

***MIDI messages that can be sent
and received using the USB port***

General Guide

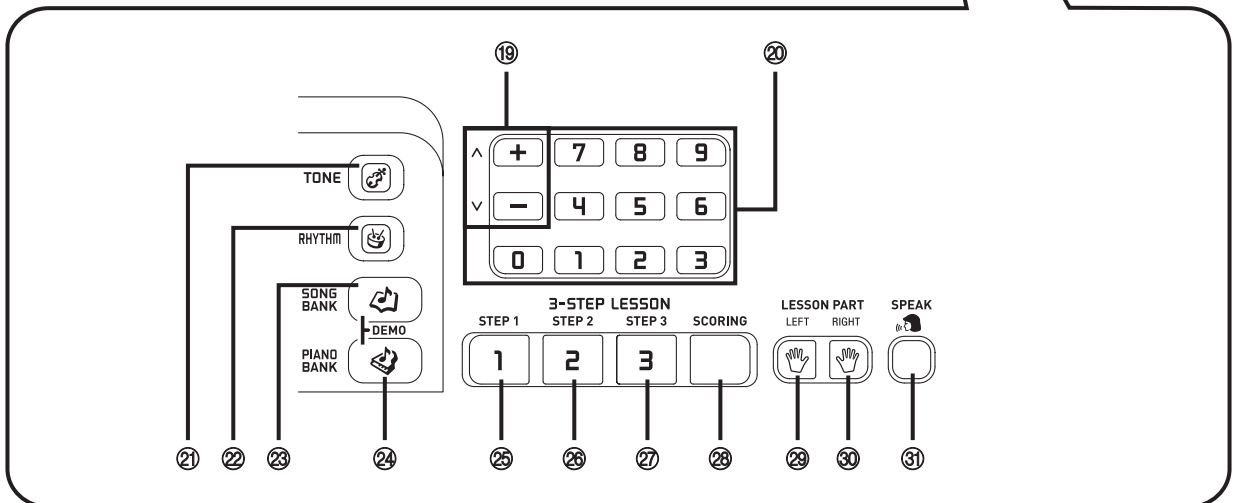
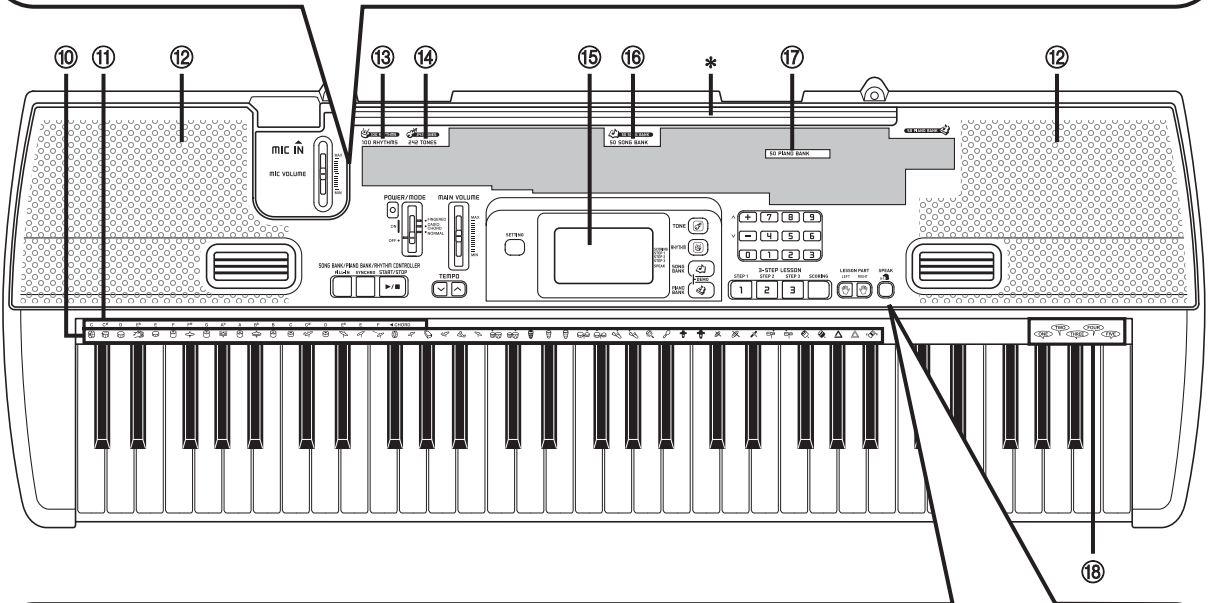
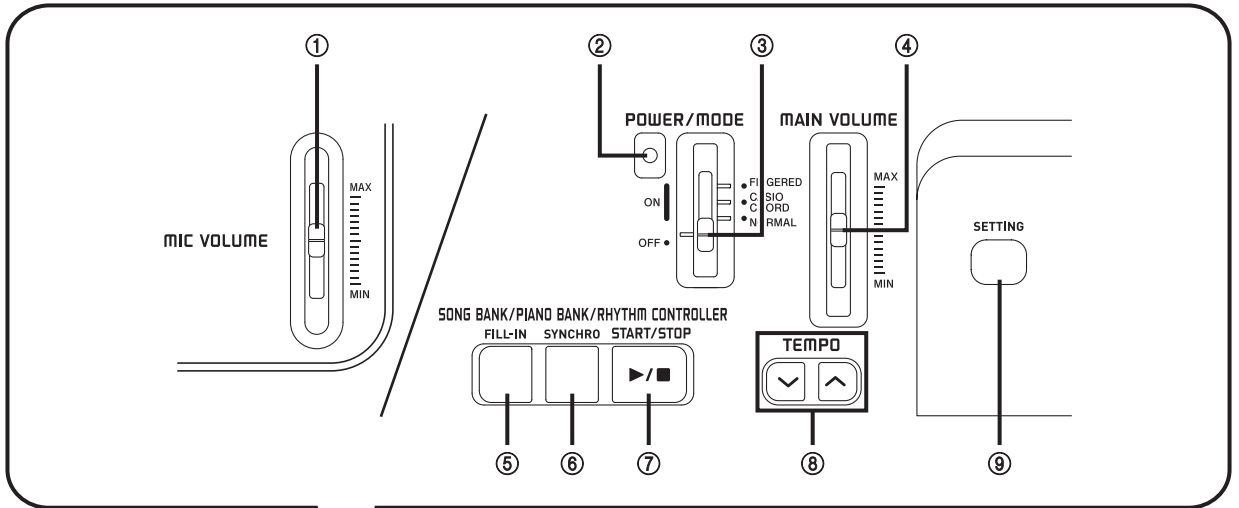

- ① MIC VOLUME slider
- ② Power indicator
- ③ POWER/MODE switch
- ④ MAIN VOLUME slider
- **SONG BANK/PIANO BANK/RHYTHM CONTROLLER**
 - ⑤ FILL-IN button
 - ⑥ SYNCHRO button
 - ⑦ START/STOP button
- ⑧ TEMPO buttons
- ⑨ SETTING button
- ⑩ Percussion instrument list
- ⑪ CHORD root names
- ⑫ Speaker
- ⑬ Rhythm list
- ⑭ Tone list
- ⑮ Display
- ⑯ Song Bank list
- ⑰ Piano Bank list
- ⑱ COUNT VOICE 1 to 5
- ⑲ [+] / [-] buttons
 - Negative values can be changed only by using [+] and [-] to increase and decrease the displayed value.
- ⑳ Number buttons
 - For input of numbers to change displayed settings.
- ㉑ TONE button
- ㉒ RHYTHM button
- ㉓ SONG BANK button
- ㉔ PIANO BANK button
- **3-STEP LESSON**
 - ㉕ STEP 1 button
 - ㉖ STEP 2 button
 - ㉗ STEP 3 button
 - ㉘ SCORING button
 - ㉙ LEFT button
 - ㉚ RIGHT button
 - ㉛ SPEAK button

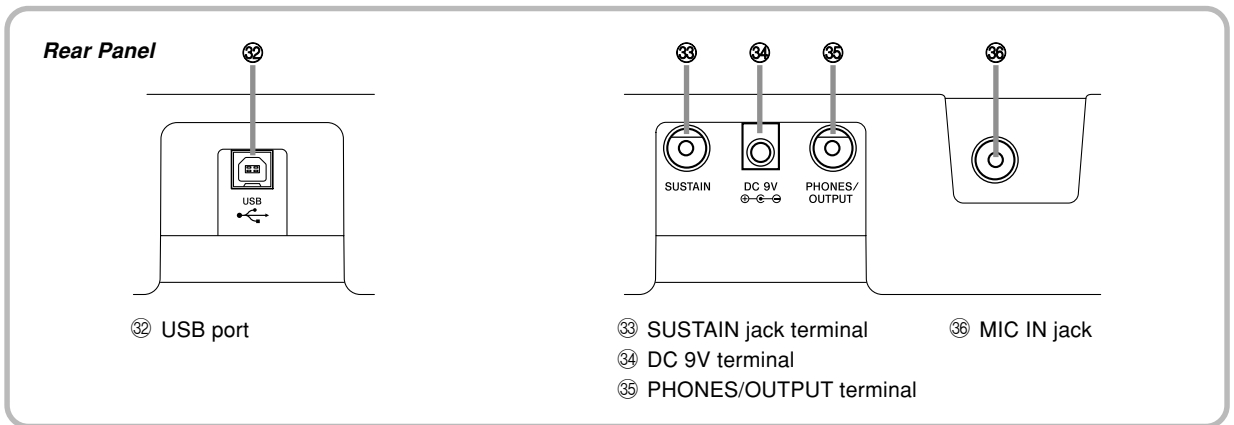

***Attachment of the Score Stand**

Insert both ends of the music stand provided with the keyboard into the two holes on the top surface.

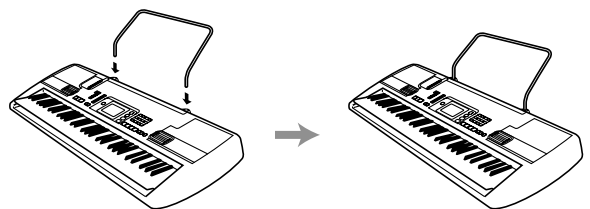

NOTE

- Display examples shown in this User's Guide are intended for illustrative purposes only. The actual text and values that appear on the display may differ from the examples shown in this User's Guide.
- Viewing a liquid crystal display screen from an angle can change the appearance of display contrast. The display contrast of this keyboard is set to allow easy viewing for a person seated on a chair in front of the keyboard. Note that display contrast is fixed, and cannot be adjusted.

Quick Reference

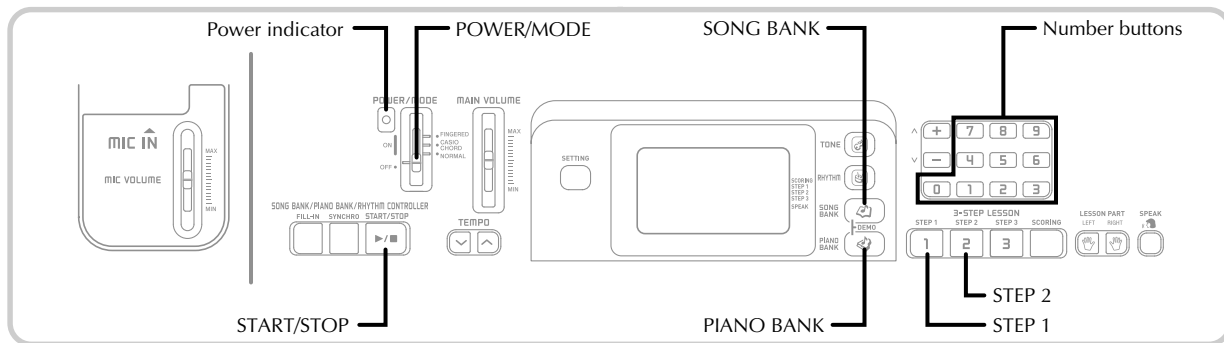

This section provides a quick overview of keyboard operation using steps one and two of the 3-step lesson feature. With the 3-step lesson feature, the on-screen keyboard guide keys light to show the next note of the tune.

To play the keyboard

- 1 Set the POWER/MODE switch to NORMAL.
 - This causes the power indicator to light.

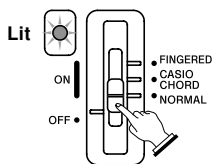

- 2 Press the SONG BANK button.



- 3 Find the tune you want to play in the SONG BANK List, and then use the number buttons to input its two-digit number.
 - See page A-9 for the SONG BANK List.
 - Example:* To select "40 ALOHA OE", input 4 and then 0.



- 4 Press the STEP 1 button or STEP 2 button.
 - The keyboard sounds a count beat and waits for you to play something on the keyboard. The keys that you need to press first flash on the display.
- 5 Play the melody along with the selected tune's accompaniment.
 - Play in accordance with the keyboard keys, fingerings and notes that appear on the display.

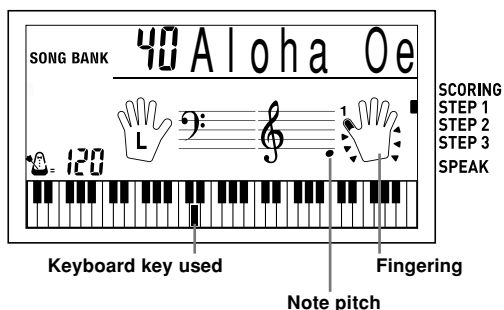

If you selected lesson Step 1

- Play the notes on the keyboard.
- Accompaniment (left-hand part) plays in time with the notes.
- With Step 1, the correct melody note is played no matter which keyboard key you press.

If you selected lesson Step 2

- Play the correct notes on the keyboard.
- While an on-screen keyboard guide key is lit, press the corresponding key on the actual keyboard. In the case of a Piano Bank tune, the keyboard guide indication turns off when you press a keyboard key, and the on-screen keyboard guide key lights for the next note to be played.
- Accompaniment (left-hand part) plays in time with the notes, as long as you press the correct keyboard keys.



- 6 To stop play at any time, press the START/STOP button.

To play an Etude or Concert Piece tune

- 1 When you get to step 2 of the above procedure, press the PIANO BANK button in place of the SONG BANK button.

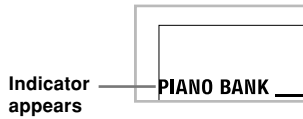

- 2 Find the tune you want to play in the PIANO BANK List, and then use the number buttons to input its two-digit number.
 - See page A-9 for the PIANO BANK List.
- 3 Next, continue from step 4 of the above procedure.

Power Supply

This keyboard can be powered by current from a standard household wall outlet (using the specified AC adaptor) or by batteries. Always make sure you turn the keyboard off whenever you are not using it.

Using batteries

Always make sure you turn off the keyboard before loading or replacing batteries.

To load batteries

- 1 Remove the battery compartment cover.

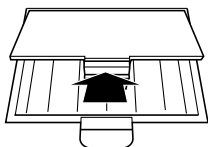

- 2 Load 6 AA-size batteries into the battery compartment.
 - Make sure that the positive (+) and negative (-) ends are facing correctly.

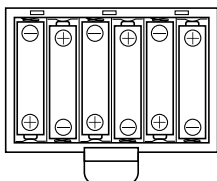

- 3 Insert the tabs on the battery compartment cover into the holes provided and close the cover.

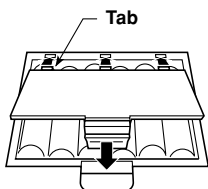

NOTE

- The keyboard may not function correctly if you load or replace batteries with power turned on. If this happens, turning the keyboard off and then back on again should return functions back to normal.

Important Battery Information

- The following shows the approximate battery life.

Alkaline batteries 4 hours

Manganese batteries 2 hours

The above value is standard battery life at normal temperature, with the keyboard volume at medium setting. Temperature extremes or playing at very loud volume settings can shorten battery life.

⚠ WARNING

Misuse of batteries can cause them to leak, resulting in damage to nearby objects, or to explode, creating the risk of fire and personal injury. Always make sure you observe the following precautions.

- Never try to take batteries apart or allow them to become shorted. ⓧ
- Never expose batteries to heat or dispose of them by incineration.
- Never mix old batteries with new ones.
- Never mix batteries of different types.
- Do not charge the batteries.
- Make sure the positive (+) and negative (-) ends of the batteries are facing correctly.

⚠ CAUTION

Misuse of batteries can cause them to leak resulting in damage to nearby objects, or to explode, creating the risk of fire and personal injury. Always make sure you observe the following precautions.

- Use only batteries that are specified for use with this product. ⓧ
- Remove batteries from the product if you do not plan to use it for a long time.

Using the AC Adaptor

Make sure that you use only the AC adaptor specified for this keyboard.

Specified AC Adaptor: AD-5

[Rear Panel]

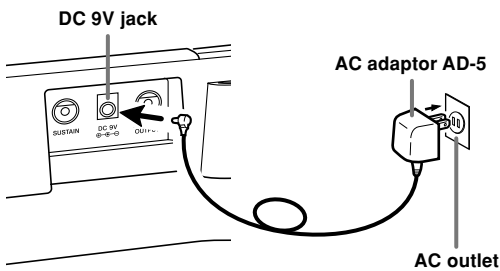

Note the following important precautions to avoid damage to the power cord.

● During Use

- Never pull on the cord with excessive force.
- Never repeatedly pull on the cord.
- Never twist the cord at the base of the plug or connector.
- The power cord should not be stretched tight while it is in use.

● During Movement

- Before moving the keyboard, be sure to unplug the AC adaptor from the power outlet.

● During Storage

- Loop and bundle the power cord, but never wind it around the AC adaptor.

IMPORTANT!

- Make sure that the keyboard is turned off before connecting or disconnecting the AC adaptor.
- Using the AC adaptor for a long time can cause it to become warm to touch. This is normal and does not indicate malfunction.

Auto Power Off

When you are using battery power, keyboard power turns off automatically whenever you leave it on without performing any operation for about 6 minutes. When this happens, use the POWER/MODE switch to turn power back on.

NOTE

- Auto Power Off is disabled (it does not function) when you are using the AC adaptor to power the keyboard.

To disable Auto Power Off

Hold down the TONE button while turning on the keyboard to disable Auto Power Off.

NOTE

- When Auto Power Off is disabled, the keyboard does not turn off automatically no matter how long it is left with no operation being performed.
- Auto Power Off is automatically enabled whenever you turn on keyboard power.

Settings

All keyboard settings are returned to their initial defaults whenever keyboard power is turned back on after being turned off by operation of the POWER/MODE switch or Auto Power Off.

Connections

Phones/Output Terminal

Before connecting phones or other external equipment, be sure to first turn down the volume settings of the keyboard and the connected equipment. You can then adjust volume to the desired level after connections are complete.

[Rear Panel]

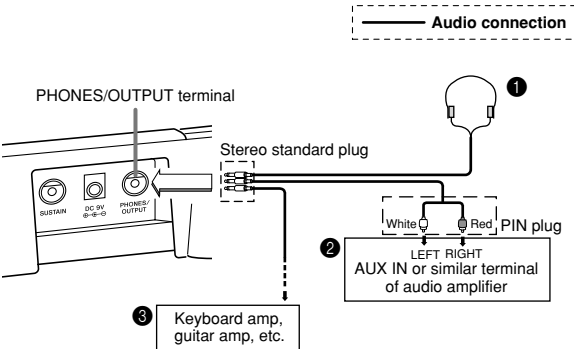

Connecting Phones (Figure 1)

Connecting phones cuts off output from the keyboard's built-in speakers, so you can play even late at night without disturbing anyone.

Audio Equipment (Figure 2)

Connect the keyboard to a audio equipment using a commercially available connecting cord with a standard plug on one end and two PIN plugs on the other end. Note that the standard plug you connect to the keyboard must be a stereo plug, otherwise you will be able to output only one of stereo channels. In this configuration, you normally set the input selector of the audio equipment to the terminal (usually marked AUX IN or something similar) where the cord from the keyboard is connected. See the user documentation that comes with your audio equipment for full details.

Musical Instrument Amplifier (Figure 3)

Use a commercially available connecting cord* to connect the keyboard to a musical instrument amplifier.

* Be sure to use a connecting cord that has a stereo standard plug on the end you connect to the keyboard, and a connector that provides dual channel (left and right) input to the amplifier to which you are connecting. The wrong type of connector at either end can cause one of the stereo channels to be lost.

When connected to a musical instrument amplifier, set the volume of the keyboard to a relatively low level and make output volume adjustments using the amplifier's controls.

[Connection Example]

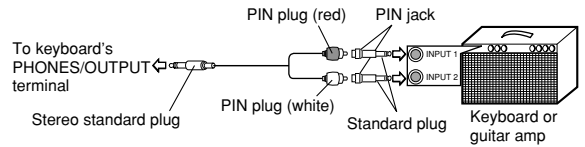

Connecting to a Computer or Other Equipment

You can also connect the keyboard to a computer or sequencer. See "Connecting to a Computer" on page E-30 for details.

Sustain jack Terminal

You can connect an optional sustain pedal (SP-3 or SP-20) to the SUSTAIN jack terminal to enable the capabilities described below.

SUSTAIN jack Terminal

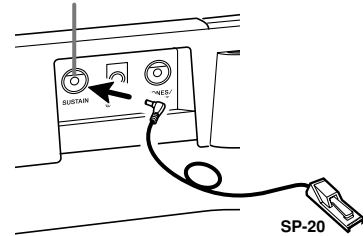

Sustain Pedal

- With piano tones, depressing the pedal causes notes to linger, much like a piano's damper pedal.
- With organ tones, depressing the pedal causes notes to continue to sound until the pedal is released.

Microphone Jack

You can connect a commercially available microphone to the microphone jack and sing along with notes played on the keyboard. For details, see "Using the Microphone Jack" on page E-16.

Accessories and Options

Use only the accessories and options specified for this keyboard. Use of non-authorized items creates the danger of fire, electrical shock, and personal injury.

Basic Operations

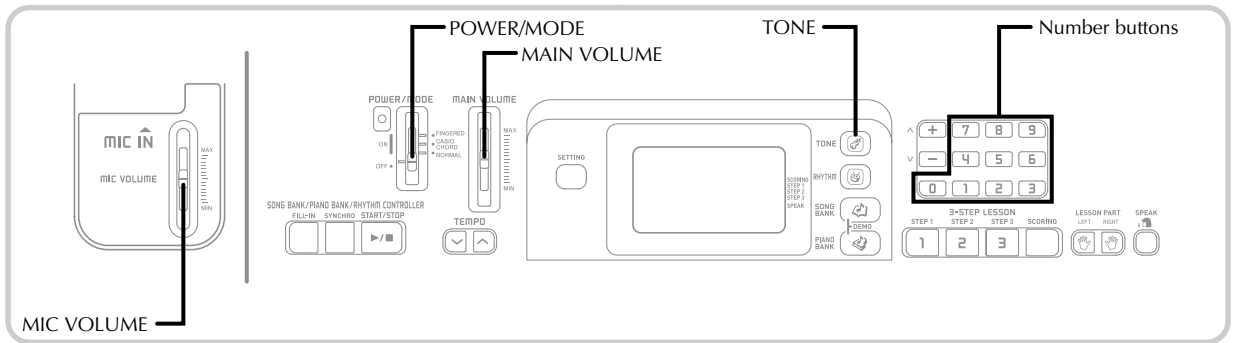

This section provides information on performing basic keyboard operations.

Playing the Keyboard

To play the keyboard

- 1 Set the POWER/MODE switch to NORMAL.
- 2 Use the MAIN VOLUME slider to lower the keyboard volume.
 - It's always a good idea to set the keyboard volume at a relatively low level before playing.
- 3 Play something on the keyboard.

Selecting a Tone

This keyboard comes with 242 built-in tones. Use the following procedure to select the tone you want to use.

To select a tone

- 1 Find the tone you want to use in the TONE List and note its tone number.
 - Not all of the available tones are shown on the tone list printed on the keyboard console. For a complete list, see the "Tone List" on page A-1.
- 2 Press the TONE button.

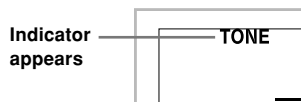

- 3 Use the number buttons to input the three digit tone number for the tone you want to select.

Example: To select "041 ACOUSTIC BASS", input 0, 4 and then 1.



NOTE

- Always input all three digits for the tone number, including leading zeros (if any). If you input one or two digits and stop, the display will automatically clear your input after a few seconds.
- You can also increment the displayed tone number by pressing [+], and decrement it by pressing [-].

Combination tones

The following describes the two types of combination tones that are available.

Layered Tones (Tone Numbers: 098 through 107)

Example: 098 STRINGS PIANO

This tone layers a strings tone with a piano tone so they both sound when a keyboard key is pressed.

Split Tones (Tone Numbers: 108 through 112)

Example: 108 BASS/PIANO

This tone splits the keyboard so one range is assigned a bass tone and another range is assigned a piano tone.

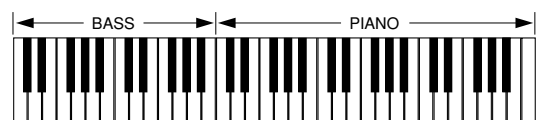

Percussion sounds

Example: 241 DRUM SET

This tone assigns various percussion sounds to the keyboard. See the "Percussion Instrument List" on page A-5 for full details.

Polyphony

The term polyphony refers to the maximum number of notes you can play at the same time. The keyboard has 32-note polyphony, which includes the notes you play as well as the rhythms and auto-accompaniment patterns that are played by the keyboard. This means that when a rhythm or auto-accompaniment pattern is being played by the keyboard, the number of notes (polyphony) available for keyboard play is reduced. Also note that some of the tones offer only 16-note polyphony.

NOTE

- When rhythm or auto accompaniment is playing, the number of sounds simultaneously played is reduced.

Using the Microphone Jack

Connecting a commercially available microphone to the MIC IN jack makes it possible to sing along with the keyboard's built-in tunes. When connecting a microphone, be sure to first adjust the MIC VOLUME to a relatively low setting, and then adjust to the level you want after connecting.

- 1 Set the MIC VOLUME slider setting so it is on the "MIN" side.
- 2 Turn on the microphone's ON/OFF switch.
- 3 Use the MIC VOLUME slider to adjust microphone volume to the level you want.

[Rear Panel]

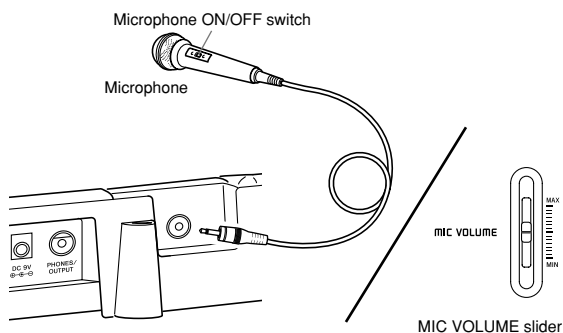

IMPORTANT!

- Be sure to use the microphone's ON/OFF switch to turn off the microphone and to disconnect the microphone from the keyboard whenever you are not using it.

Recommended Microphone Type

- Dynamic microphone (standard plug)

IMPORTANT!

- Be sure to disconnect the microphone from the keyboard whenever you are not using it.

Howling (Feedback Noise)

Any of the following conditions can cause howling (feedback noise).

- Covering the head of the microphone with your hand
- Positioning the microphone too near to a speaker

Should howling occur, try grasping the microphone further away from the head, and move away from any nearby speaker.

Static Noise

Fluorescent lighting can cause static noise in the microphone signal. When this happens, move away from the lighting you suspect may be causing the static.

Auto Accompaniment

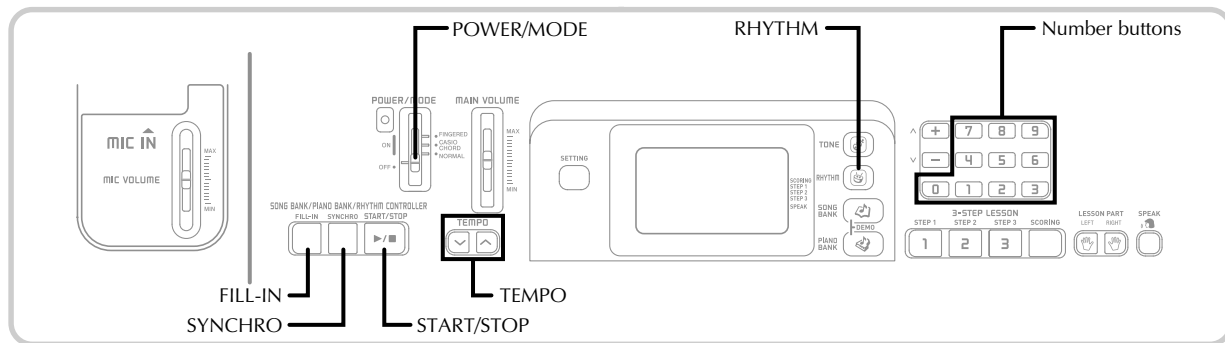

This keyboard automatically plays bass and chord parts in accordance with the chords you finger. The bass and chord parts are played using sounds and tones that are automatically selected to select the rhythm you are using. All of this means that you get full, realistic accompaniments for the melody notes you play with your right hand, creating the mood of an one-person ensemble.

Selecting a Rhythm

This keyboard provides you with 100 exciting rhythms that you can select using the following procedure.

To select a rhythm

- Find the rhythm you want to use in the RHYTHM List and note its rhythm number.
 - Not all of the available rhythms are shown on the rhythm list printed on the keyboard console. For a complete list, see the "Rhythm List" on page A-8.

- Press the RHYTHM button.

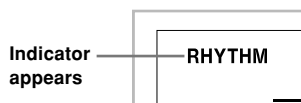

- Use the number buttons to input the two digit rhythm number for the rhythm you want to select. *Example:* To select "48 WALTZ 1", input 4 and then 8.

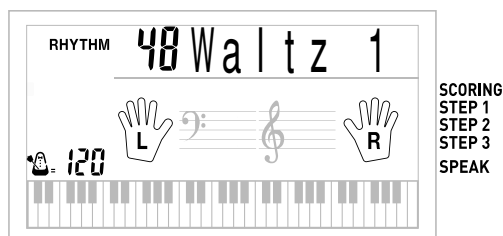

NOTE

- "00 8 Beat 1" is the initial default rhythm setting whenever you turn on keyboard power.
- You can also increment the displayed rhythm number by pressing [+], and decrement it by pressing [-].
- Accompaniment sounds (chords, bass, etc.) do not sound while a metronome rhythm (No. 95 to 99: 0, 2, 3, 4, 6) is being used, even if the POWER/MODE switch setting is "CASIO CHORD" or "FINGERED". Because of this, you should set the POWER/MODE switch to "NORMAL" when using a metronome rhythm.

Playing a Rhythm

Use the following procedure to start and stop rhythm play.

To play a rhythm

- Set the POWER/MODE switch to NORMAL.
- Press the START/STOP button to start play of the currently selected rhythm.
- To stop rhythm play, press the START/STOP button again.

NOTE

- All of the keyboard keys are melody keys while the POWER/MODE switch is set to NORMAL.

Adjusting the Tempo

You can adjust the tempo of rhythm play within a range of 40 to 255 beats per minute. The tempo setting is applied to Auto Accompaniment chord play, and song bank operations.

To adjust the tempo

1 Use the TEMPO buttons (∧ / ∨) to adjust the tempo.

∧ : Increases the tempo value.

∨ : Decreases the tempo value.

Example: Hold down the ∨ button until the tempo value 110 is on the display.



NOTE

- Pressing both TEMPO buttons (∧ and ∨) at the same time resets the tempo to the default value of the currently selected rhythm.

About the Graphic Metronome

The graphic metronome appears on the display along with the tempo value and beat of a rhythm or built-in tune. The graphic metronome helps you keep in time as you play along with a rhythm or built-in tune.

Graphic metronome Tempo value



Using Auto Accompaniment

The following procedure describes how to use the keyboard's Auto Accompaniment feature. Before starting, you should first select the rhythm you want to use and set the tempo of the rhythm to the value you want.

To use Auto Accompaniment

1 Set the POWER/MODE switch to CASIO CHORD or FINGERED.

2 Press the START/STOP button to start play of the currently selected rhythm.

3 Play a chord.

- The actual procedure you should use to play a chord depends on the current POWER/MODE switch position. Refer to the following pages for details on chord play.

CASIO CHORD This page

FINGERED Page E-19

Chord name

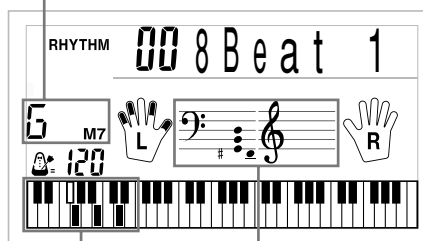

SCORING
STEP 1
STEP 2
STEP 3
SPEAK

Basic fingering of current chord
(May be different from chord actually
being played on the keyboard.)

4 To stop Auto Accompaniment play, press the START/STOP button again.

NOTE

- If you press the SYNCHRO button in place of the START/STOP button in step 2, the rhythm pattern starts to play automatically when you perform the operation in step 3. For details about these buttons, see page E-20.
- You can adjust the accompaniment part volume level independently of the main volume. For details, see "Adjusting Accompaniment and Song Bank Volume" on page E-28.

CASIO CHORD

This method of chord play makes it possible for anyone to easily play chords, regardless of previous musical knowledge and experience. The following describes the CASIO CHORD "Accompaniment keyboard" and "Melody keyboard", and tells you how to play CASIO CHORDS.

CASIO CHORD Accompaniment Keyboard and Melody Keyboard

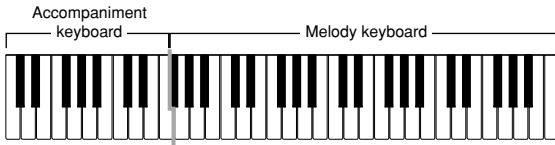

NOTE

- The accompaniment keyboard can be used for playing chords only. No sound will be produced if you try playing single melody notes on the accompaniment keyboard.

Chord Types

CASIO CHORD accompaniment lets you play four types of chords with minimal fingering.

Chord types	Example
<p>Major chords Major chord names are marked above the keys of the accompaniment keyboard. Note that the chord produced when you press an accompaniment keyboard does not change octave, regardless of which key you use to play it.</p>	<p>C Major (C)</p>
<p>Minor chords (m) To play a minor chord, keep the major chord key depressed and press any other accompaniment keyboard key located to the right of the major chord key.</p>	<p>C minor (Cm)</p>
<p>Seventh chords (7) To play a seventh chord, keep the major chord key depressed and press any other two accompaniment keyboard keys located to the right of the major chord key.</p>	<p>C seventh (C7)</p>
<p>Minor seventh chords (m7) To play a minor seventh chord, keep the major chord key depressed and press any other three accompaniment keyboard keys located to the right of the major chord key.</p>	<p>C minor seventh (Cm7)</p>

NOTE

- It makes no difference whether you press black or white keys to the right of a major chord key when playing minor and seventh chords.

FINGERED

FINGERED provides you with a total of 15 different chord types. The following describes the FINGERED “Accompaniment keyboard” and “Melody keyboard”, and tells you how to play a C-root chord using FINGERED.

FINGERED Accompaniment Keyboard and Melody Keyboard

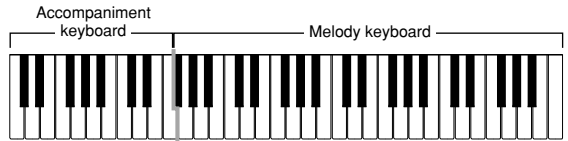

NOTE

- The accompaniment keyboard can be used for playing chords only. No sound will be produced if you try playing single melody notes on the accompaniment keyboard.

<p>C</p>	<p>Cm</p>	<p>Cdim</p>
<p>Caug^{*1}</p>	<p>Csus4</p>	<p>C7^{*2}</p>
<p>Cm7^{*2}</p>	<p>Cmaj7^{*2}</p>	<p>Cm7^{*5}</p>
<p>C7^{♯5}*1</p>	<p>C7sus4</p>	<p>Cadd9^{*2}</p>
<p>Cmadd9^{*2}</p>	<p>CmM7^{*2}</p>	<p>Cdim7^{*1}</p>

See the “Fingered Chord Chart” on page A-6 for details on playing chords with other roots.

- *1: Inverted fingerings cannot be used. The lowest note is the root.
- *2: The same chord can be played without pressing the 5th G.

NOTE

- Except for the chords specified in note^{*1} above, inverted fingerings (i.e. playing E-G-C or G-C-E instead of C-E-G) will produce the same chords as the standard fingering.
- Except for the exception specified in note^{*2} above, all of the keys that make up a chord must be pressed. Failure to press even a single key will not play the desired FINGERED chord.

Using a Fill-in Pattern

Fill-in patterns let you momentarily change the rhythm pattern to add some interesting variation to your performances.

The following procedure describes how to use the Fill-in feature.

To insert a fill-in

- 1 Press the START/STOP button to start rhythm play.
- 2 Press the FILL-IN button to insert a fill-in pattern for the rhythm you are using.

Synchro Starting Accompaniment with Rhythm Play

You can set up the keyboard to start rhythm play at the same time you play the accompaniment on the keyboard.

The following procedure describes how to use synchro start. Before starting, you should first select the rhythm you want to use, set the tempo, and use the POWER/MODE switch to select the chord play method you want to use (CASIO CHORD, FINGERED).

To use synchro start

- 1 Press the SYNCHRO button to put the keyboard into synchro start standby.

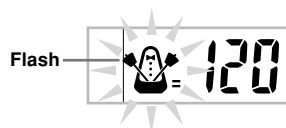

- 2 Play a chord on the accompaniment keyboard and the rhythm pattern starts to play automatically.

NOTE

- If the POWER/MODE switch is set to NORMAL, only the rhythm plays (without a chord) when you play on the accompaniment keyboard.
- To cancel synchro start standby, press the SYNCHRO button one more time.

Playing a Built-in Tune

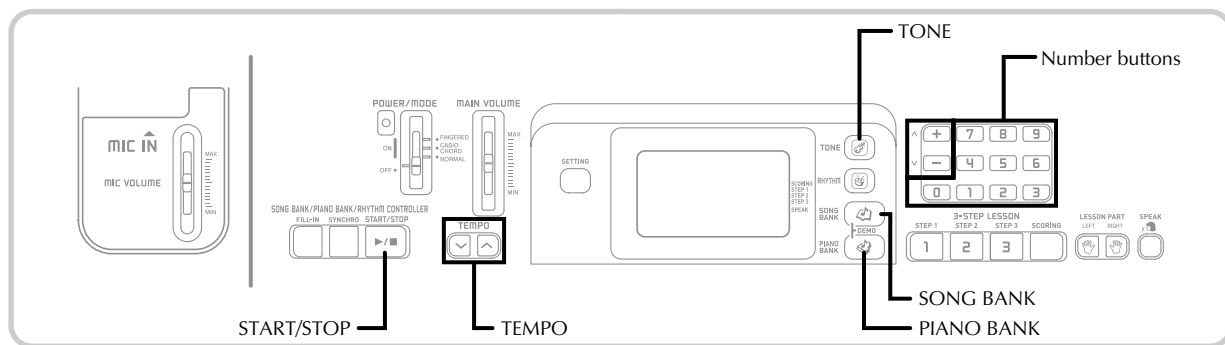

Your keyboard comes with a total of built-in 100 tunes. You can play back built-in tunes for your own listening pleasure, or you can use them for practice and even sing-along. Built-in tunes are divided between the two groups described below.

- Song Bank: 50 tunes
The tunes in this group are Auto Accompaniment tunes.
- Piano Bank Group: 50 tunes
The tunes in this group are piano tunes.

To play back a Song Bank tune

PREPARATION

- Adjust the main volume (page E-15).

- 1 Find the tune you want to play in the SONG BANK List, and note its number.
 - See page A-9 for the SONG BANK List.
- 2 Press the SONG BANK button to enter the Song Bank Mode.

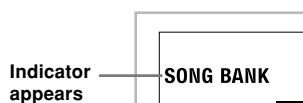

- 3 Use the number buttons to input the tune's two-digit number.
Example: To select "40 ALOHA OE", input 4 and then 0.

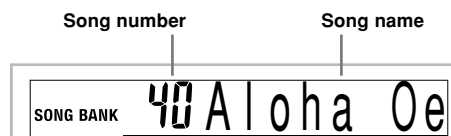

NOTE

- Tune Number 00 is the initial default Song Bank tune setting whenever you turn on keyboard power.
- You can also increment the displayed tune number by pressing [+], and decrement is by pressing [-].

- 4 Press the START/STOP button to start play of the tune.

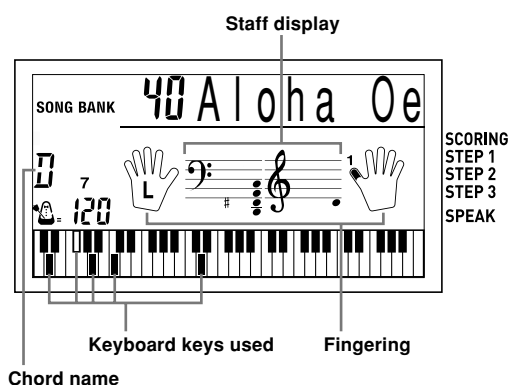

- 5 Press the START/STOP button to stop playback of the Song Bank tune.
 - The tune you select continues to play until you stop it.

To play back a Piano Bank tune

- 1 Find the tune you want to play in the PIANO BANK List, and note its number.
 - See page A-9 for the PIANO BANK List.
- 2 Press the PIANO BANK button to specify the Piano Bank group.

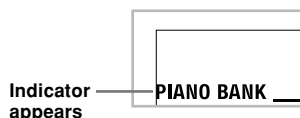

NOTE

- Pressing the PIANO BANK button changes the tone to STEREO GRAND PIANO (Tone Number 000).

- 3 Use the number buttons to input the two-digit tune number you looked up in step 1.

Example: To select tune number 03 (Ode To Joy), input 0 and then 3.



NOTE

- Tune Number 00 is the initial default Piano Bank tune setting whenever you turn on keyboard power.
- You can also change the displayed tune number using the [+] and [-] buttons.

- 4 Press the START/STOP button to start playback.
- 5 To stop playback, press the START/STOP button.
 - The tune you select continues to play until you stop it.

Adjusting the Tempo

Each tune has a preset default tempo (beats per minute) that is set automatically whenever you select a tune. While the tune is playing, you can change the tempo setting to a value in the range of 40 to 255.

To set the tempo

- 1 Use the TEMPO buttons to set the tempo.
 - ∧ : Increases the tempo value.
 - ∨ : Decreases the tempo value.



NOTE

- While the tempo value is flashing, you can also use the number buttons or [+] and [-] to input a three-digit value. Note that you must input leading zeros, so 90 is input as 090.
- Pressing both the ∧ and ∨ TEMPO buttons at the same time automatically returns the currently selected rhythm to its default tempo.
- Piano Bank tunes have tempo changes part way through in order to produce specific musical effects. Note that the tempo setting automatically returns to the default whenever a tempo change occurs within one of these tunes.



To change the melody tone

- 1 Press the TONE button.

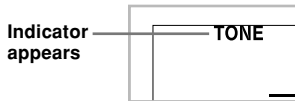

- 2 Find the tone you want in the TONE List, and then use the number buttons to input its three-digit number.

Example: To select “049 VIOLIN”, input 0, then 4, then 9.

- You can select any one of the keyboard’s built-in tones.



NOTE

- You can also use the [+] and [-] buttons to change the melody tones.
- For two-hand tunes (Piano Bank tunes), the same tone is applied for both the left and right hand parts.
- Specifying the tune number for the same tune that is currently selected returns the melody tone to the default setting for that tune.

To play all tunes in succession

- 1 Press the SONG BANK button and PIANO BANK button at the same time.
 - Playback starts from Song Bank tune number 00, followed in sequence by Piano Bank tunes.
- 2 To stop tune play, press the START/STOP button.

NOTE

- While a tune is playing, you can use the number buttons or [+] and [-] to change to another tune.
- You can play along with the tunes on the keyboard.

Using the PIANO BANK Button

Pressing the PIANO BANK button provides instant access to piano tones and piano tune selection.

Initial Piano Bank Setting

Tone: 000 STEREO GRAND PIANO

To use the piano bank

- 1 Press the PIANO BANK button.

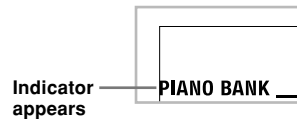

- 2 Now try playing something on the keyboard.
 - The notes you play sound with a piano tone.
- 3 If you want to playback the built-in tune, press the START/STOP button.
 - This causes the currently selected tune to play in an endless loop.
 - To stop playback, press the START/STOP button again.

3-Step Lesson

With the 3-Step Lesson System, you can practice built-in tunes and even plot your progress according to the evaluation points the keyboard awards you.

Lesson Progress



3-Step Lesson

The 3-step lesson feature takes you through the three distinct steps described below to help you learn to play tunes on the keyboard.

Step 1 – Master the timing.

Step 2 – Master the notes.

Step 3 – Play at normal speed.

Tune Types and Their Parts

Song Bank Tunes

When using these tunes for a 3-step lesson, you can practice playing along with the melody (right hand) part only.

Piano Bank Tunes

When using these tunes for a 3-step lesson, you can practice playing along with both the left hand and right hand parts.

Display Contents During 3-step Lesson Play

Whenever you select an Auto Accompaniment tune for 3-step lesson play, the on-screen keyboard guide and staff notation shows the note you should play and its length. The on-screen keyboard guide also shows the notes you play on the keyboard. The following describes the information that appears on the display.

Note Pitch

The key you should press lights on the on-screen keyboard guide, while the actual pitch of the note appears in the display's staff notation area. The fingers you should use to play the notes are also shown on the display.

Note Length

The key stays lit on the on-screen keyboard guide for as long as the note should be sustained. The staff notation and fingerings also remain on the display for the length of the note.

Next Note

An on-screen keyboard guide key flashes to indicate the next note to be played, while a number appears on the display near the finger you should use to play the next note.

Series of Same Pitch Notes

The on-screen keyboard guide key turns off momentarily between the notes, and lights again for each successive note. The staff notation and fingerings also turn off and back on again.

Example: When play requires pressing keys with fingers 3, 2, and then 1

1st Note: Next note 2, Current note. Hand diagram shows finger 2. On-screen keyboard guide shows 'Flash Lit'.

2nd Note: Hand diagram shows finger 1. On-screen keyboard guide shows 'Flash Lit'.

3rd Note: Hand diagram shows finger 5. On-screen keyboard guide shows 'Lit Flash'.

NOTE

- Note length is not indicated when you are using Piano Bank tunes with 3-step lesson Steps 1 and 2. As soon as you press a key that is lit on the on-screen keyboard guide, it goes out and the next key you need to press starts to flash.
- Note length is indicated by the on-screen keyboard guide when you use Piano Bank tunes with Step 3. In this case, the next key to be pressed does not flash when you press a lit key and the next finger number does not appear on the display. Only the current finger number is shown.

3-step Lesson Tempo Setting

Use the procedure under “Adjusting the Tempo” on page E-22 to adjust the tempo for 3-step lesson play.

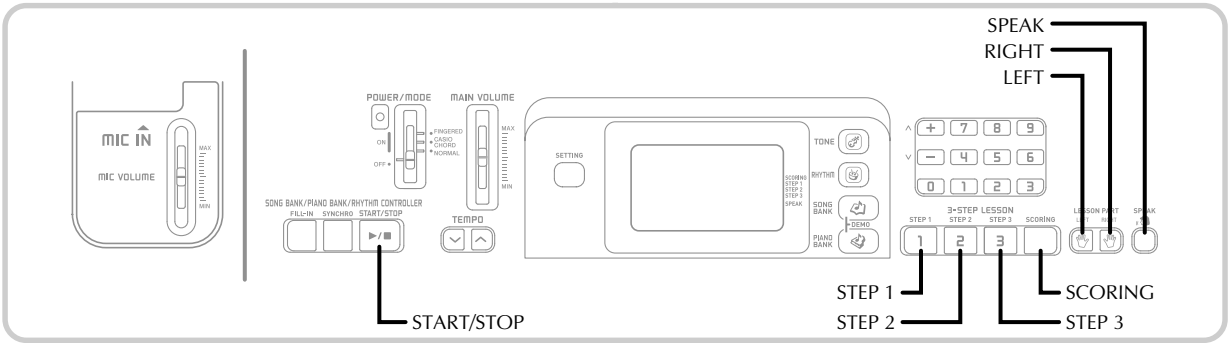

Evaluation Mode

The keyboard's Evaluation Mode awards points to your performances during Step 3 of the 3-Step Lesson. A perfect score is 100. Also, the Evaluation Mode provides comments about your play on the monitor screen.

Evaluation Mode Display

Level Indicator (9 Levels): This indicator shows the evaluation of your current performance at a glance. The more segments that appear, the higher your points.

Example: 50 points



Evaluation Results

After you finish playing, the keyboard calculates an evaluation of your total performance, from beginning to end, and displays your total score on the monitor screen. The greater the score, the higher your evaluation is.

Evaluation Rank Display Messages

Display Message	Evaluation Ranges
"Bravo!"	<High>
"Great!"	
"Not bad!"	
"Again!"	<Low>

"*****" : indicates that the Evaluation Mode was exited before an evaluation result could be obtained.

NOTE

- If you press the START/STOP button and interrupt the Evaluation Mode part way through, the monitor screen shows the evaluation points you have accumulated up to that point. In this case, the keyboard does not display a message.

Using the Lesson Functions and Evaluation Mode

Perform the following steps to master your favorite tunes.

Step 1 – Master the timing.

- 1 Select the tune you want to use.
- 2 Press the STEP 1 button to start Step 1 play.
 - The hand you should use is indicated by arrows around it.

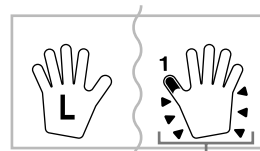

Indicators

- Left hand practice can also be performed with Piano Bank tunes. Simply select one of the Piano Bank tunes in step 1, and then press the LEFT button following step 2.

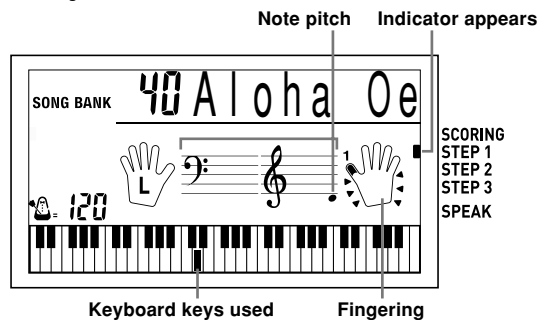

- After a count sounds, the keyboard stands by and waits for you to play the first note of the tune.
- Voice fingering guide will use a simulated human voice to call out fingering numbers. See "Voice Fingering Guide" on page E-27 for details.

- 3 Press any keyboard keys to play the notes.
 - The key for the next note to be played flashes on the on-screen keyboard guide and the keyboard waits for you to play it. When you press any key to play the note, the on-screen key remains lit as the note plays.
 - Accompaniment (left-hand part) waits until you press any key to play a note.
 - If you accidentally press more than one key in succession, accompaniment is played for the corresponding number of notes.
 - Pressing more than one key at the same time counts as a single note. Pressing a key while another key is held down is counted as two notes.
- 4 To stop play at any time, press the START/STOP button.

Step 2 – Master the notes.

- 1 Select the tune you want to use.
- 2 Press the STEP 2 button to start Step 2 play.
 - Indicators appear around the hand on the display whose part is selected for practice.
 - Left hand practice can also be performed with Piano Bank tunes. Simply select one of the Piano Bank tunes in step 1, and then press the LEFT button following step 2.

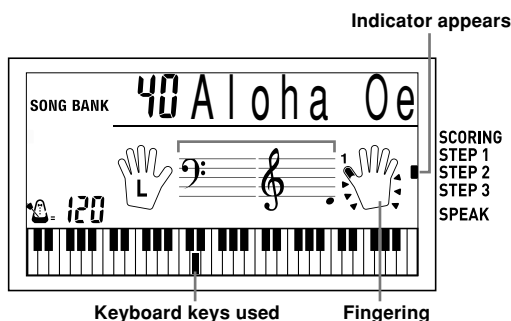

- After a count sounds, the keyboard stands by and waits for you to play the first note of the tune.
- Voice fingering guide will use a simulated human voice to call out fingering numbers. See “Voice Fingering Guide” on page E-27 for details.

- 3 Play the notes as indicated by the on-screen keyboard guide.
 - The key for the next note to be played flashes on the on-screen keyboard guide and the keyboard waits for you to play it. When you press any key to play the note, the on-screen key remains lit as the note plays.
 - If multiple keys light on the on-screen keyboard guide when you are using a two-hand tune, it means that you must press all of the keys that are lit.
- 4 To stop play at any time, press the START/STOP button.

Step 3 – Play at normal speed.

- 1 Select the tune you want to play.
- 2 Press the STEP 3 button to start Step 3 play.
 - Indicators appear around the hand on the display whose part is selected for practice.
 - Left hand practice can also be performed with Piano Bank tunes. Simply select one of the Piano Bank tunes in step 1, and then press the LEFT button following step 2.

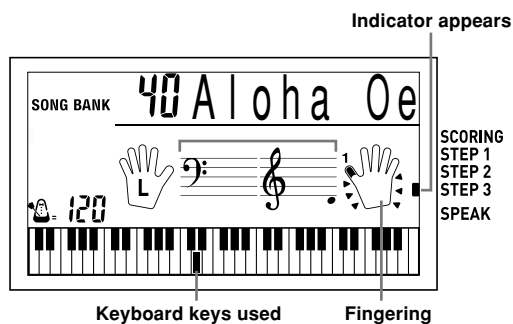

- Accompaniment (left hand part) starts to play at normal speed.

- 3 Play the notes as indicated by the on-screen keyboard guide.
- 4 To stop play at any time, press the START/STOP button.

Evaluation: Find out how the keyboard evaluates your Step 3 play.

Use the SCORING button to check the evaluation of your play in Step 3.

- 1 Press the SCORING button.
 - This causes the SCORING indicator to appear on the display.
 - A count beat sounds and then evaluation mode starts.

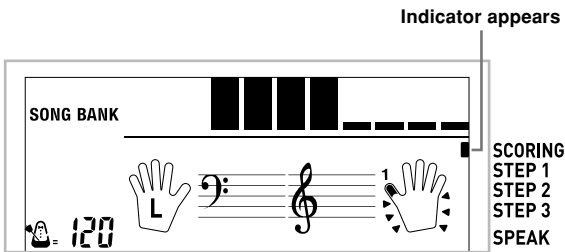

- 2 Play in accordance with the guidance on the monitor screen and as told by the voice.
 - To stop evaluation, press the START/STOP button. This displays only the points accumulated up to that point.
- 3 After you finished playing, your evaluation result appears on the display.
 - For information about evaluation ranks and sound effects, see "Evaluation Results" on page E-25.
 - Pressing the SONG BANK button returns to the tune selection screen.

095 Bravo!

Voice Fingering Guide

Voice fingering guide uses a simulated human voice to call out fingering numbers during Step 1 and Step 2 one-hand part practice. If you need to press a key with your thumb, for example, voice fingering guide says, "One!" In the case of a chord to be played with your thumb, middle and little finger, voice fingering guide says, "One, three, five!" Voice Fingering Guide calls out fingerings only when you do not press the proper key when you should.

Voice Fingering Guide

- One : Thumb
- Two : Forefinger
- Three : Middle finger
- Four : Ring finger
- Five : Little finger

To turn voice fingering guide on or off

Press the SPEAK button to toggle voice fingering guide on (voice fingering guide indicator displayed) and off (indicator not displayed).



NOTE

- Note that Voice Fingering is disabled in the Evaluation Mode.
- Exiting the Evaluation Mode automatically restores the Voice Fingering setting that was in effect when you entered the Evaluation Mode.

Keyboard Settings

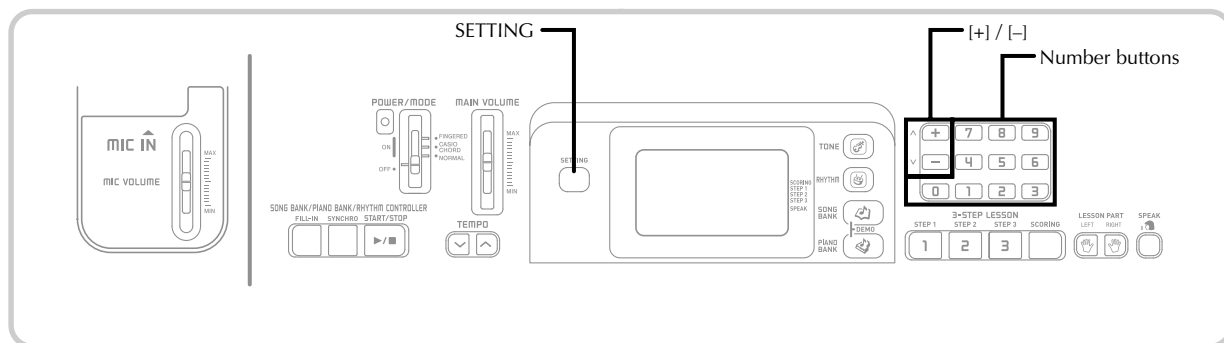

About SETTING button

Each press of the SETTING button cycles through the setting screens. If you accidentally pass the screen you want to use, keep pressing the SETTING button until the screen appears again.

Adjusting Accompaniment and Song Bank Volume

You can adjust the volume of the accompaniment and Song Bank tunes independently of the notes you play on the keyboard. You can specify a volume level in the range of 00 (minimum) to 99 (maximum).

To adjust the accompaniment volume

- 1 Press the SETTING button until the accompaniment volume adjustment screen appears.



Current accompaniment volume setting

- 2 Use the number buttons or the [+]/[-] buttons to change the current volume setting value.
Example: 80



NOTE

- The current accompaniment volume value that appears in Step 1 automatically clears from the display if you do not input anything within about five seconds.
- Pressing [+] and [-] buttons at the same time automatically sets an accompaniment volume of 99.

To adjust built-in tune volume

Enter the Song Bank mode or Piano Bank mode, and then perform the procedure under "To adjust the accompaniment volume".

- In this case, a song volume screen will appear in place of the accompaniment volume screen.

Transposing the Keyboard

Transpose lets you raise and lower the overall key of the keyboard in semitone units. If you want to play an accompaniment for a vocalist who sings in a key that's different from the keyboard, for example, simply use transpose to change the key of the keyboard.

To transpose the keyboard

- 1 Press the SETTING button until the transpose screen appears on the display.
- 2 Use [+] and [-] to change the transpose setting of the keyboard.

Example: To transpose the keyboard five semitones upwards.



**NOTE**

- The keyboard can be transposed within a range of -12 to +12.
- The default transpose setting is "00" when keyboard power is turned on.
- If you leave the transpose screen on the display for about five seconds without doing anything, the screen is automatically cleared.
- The transpose setting also affects Auto Accompaniment.
- Playing back a Song Bank tune automatically returns the transpose setting to its standard default of "00".
- The effect of a transpose operation depends on the pitch of each note and on the tone you are currently using. If a transpose operation causes a note to be outside of the allowable range for a tone, the same note in the nearest octave within the range will be substituted.

Tuning the Keyboard

Use the following procedure to fine tune the keyboard to match the tuning of another musical instrument.

To tune the keyboard

- 1 Press the SETTING button until the tuning screen appears.



- 2 Use the [+], [-], and the number buttons to adjust the tuning value.

Example: To lower tuning by 20

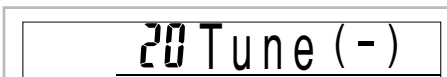
**NOTE**

- The keyboard can be tuned within a range of -50 cents to +50 cents.
* 100 cents is equivalent to one semitone.
- The default tuning setting is "00" when keyboard power is turned on.
- If you leave the tuning screen on the display for about five seconds without doing anything, the screen is automatically cleared.
- The tuning setting also affects playback from song memory and Auto Accompaniment.
- To return the keyboard to its default tuning, perform the above procedure and press the [+] and [-] buttons at the same time in step 2.

Connection to a Computer

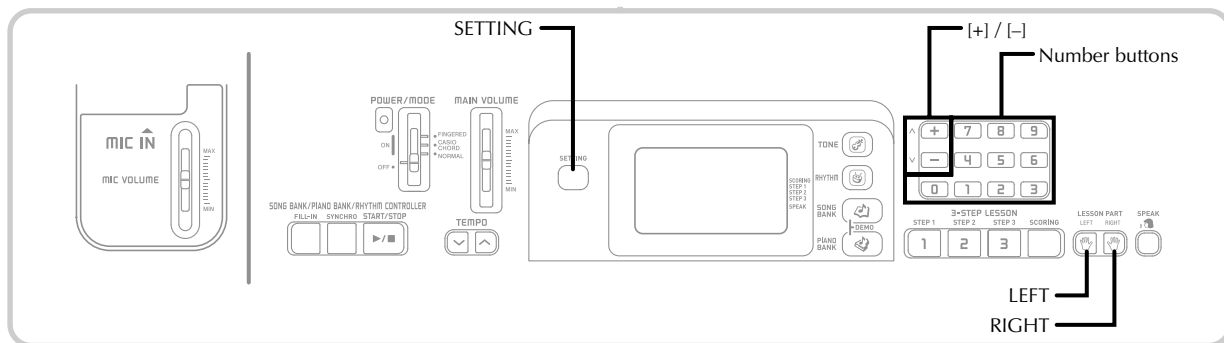

Connecting to a Computer

The keyboard's USB port makes it quick and simple to connect to a computer. After installing the USB MIDI driver onto your computer from the CD-ROM that comes with the keyboard, you will be able to use commercially available MIDI software on your computer to exchange data between the keyboard and your computer.

To install the USB MIDI driver

- 1 On the computer to which you plan to connect, install the USB MIDI driver that comes on the CD-ROM that comes bundled with the keyboard.
 - For information about installing the USB MIDI driver, see the "CASIO USB MIDI Driver User's Guide" (manual_e.pdf) on the "USB Manual and Driver CD-ROM".

NOTE

- Before starting actual installation of USB MIDI driver, be sure to read the contents of the "readme.txt" file in the "English" folder on the CD-ROM.
-
- Use Adobe Reader or Acrobat Reader to access the USB MIDI driver user's guide.*
- * You need to have Adobe Reader or Acrobat Reader installed on your computer in order to view the contents of the "CASIO USB MIDI Driver User's Guide" (manual_e.pdf). If your computer does not have either Adobe Reader or Acrobat Reader installed, use the procedure below to install it.

Installing Adobe Reader (Acrobat Reader**)

- Place the "USB Manual and Driver CD-ROM" into your computer's CD-ROM drive.
- On the CD-ROM, navigate to the folder named "Adobe", open the folder named "English", and then double-click "ar601enu.exe" ("ar505enu.exe"). Follow the instructions that appear on your computer screen to install Adobe Reader.

** Adobe Reader cannot be installed on a computer running Windows 98. If your computer is running under Windows 98, double-click "ar505enu.exe" to install Acrobat Reader.

Minimum Computer system Requirements

Supported Operating Systems

Operation is supported under Windows® XP, Windows® 2000, Windows® Me, Windows® 98SE, and Windows® 98.

● Universal

- IBM AT or compatible computer
- USB port that provides normal operation under Windows
- CD-ROM drive (for installation)
- At least 2MB of free hard disk space (not including space required for Adobe Reader)

● Windows XP

- 300MHz or higher Pentium processor
- At least 128MB of memory

● Windows 2000

- 166MHz or higher Pentium processor
- At least 64MB of memory

● Windows Me, Windows 98SE, Windows 98

- 166MHz or higher Pentium processor
- At least 32MB of memory

Driver Signing

● Windows XP

- 1 Log on to Windows XP using a Computer administrator account. See the documentation that comes with Windows XP for information about Computer administrator accounts.
- 2 On the Windows [Start] menu, click [Control Panel].
 - If you cannot see the [System] icon on the Control Panel, click [Switch to Classic View].
- 3 Click the [System] icon. On the dialog box that appears, click the [Hardware] tab, and then click the [Driver Signing] button.
- 4 On the dialog box that appears, select [Ignore], and then click [OK].

● **Windows 2000**

- 1 Log on using an Administrators group account. See the documentation that comes with Windows 2000 for information about the Administrators group.
- 2 On the Windows [Start] menu, point to [Settings] and then click [Control Panel].
- 3 Click the [System] icon. On the dialog box that appears, click the [Hardware] tab, and then click the [Driver Signing] button.
- 4 On the dialog box that appears, select [Ignore], and then click [OK].

NOTE

- Company and product names used herein are trademarks of their respective owners.

Using the USB port

Note that you need to purchase a commercially available USB cable to connect the keyboard to a computer using the USB port. Once you establish a USB connection between the keyboard and a computer, you can exchange data between them.

To connect to a computer using the USB port

- 1 Use a commercially available USB cable to connect the keyboard to the computer.

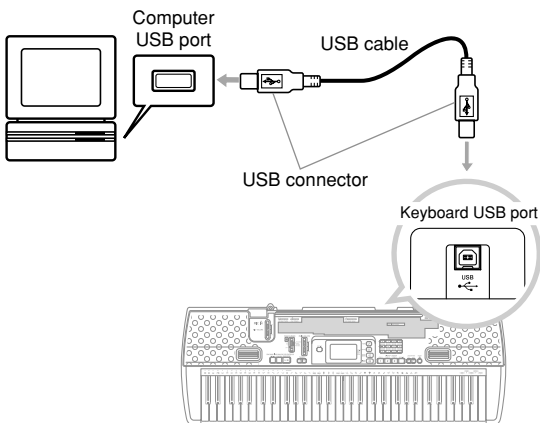

General MIDI Tone

The General MIDI standard defines the tone numbering sequence, the drum sound numbering sequence, the number of MIDI channels that can be used, and other general factors that determine the sound source configuration. Because of this, musical data produced on a General MIDI sound source can be played back using similar tones and identical nuances as the original, even when played on another manufacturers sound source.

This keyboard conforms with General MIDI standards, so it can be connected to a computer and used to play back General MIDI data that has been purchased, downloaded from the Internet, or obtained from any other source.

Changing the Settings

This section tells you how to make the settings required when connecting to a computer.

GM MODE (Default: Off)

on: Configures the keyboard for optimal General MIDI data play (tone specification matching, etc.)

oFF: Returns to default keyboard setup.

- 1 Press the SETTING button until the GM MODE screen appears.

Example: When GM MODE is turned off



- 2 Use the [+] and [-] or [0] and [1] buttons to turn the setting on and off.

Example: To turn GM MODE on



KEYBOARD CHANNEL (Default: 1)

The keyboard channel is the channel used to send messages from this keyboard to a computer. You can specify one channel from 1 to 16 as the keyboard channel.

- 1 Press the **SETTING** button until the **KEYBOARD CHANNEL** screen appears.



01 Keybd Ch

- 2 Use the **[+]**, **[-]**, and the number buttons to change the channel number.

Example: To specify channel 4



04 Keybd Ch

NAVIGATE CHANNEL (Default: 4)

When messages are received from a computer for play on this keyboard, the navigate channel is the channel whose note data appears on the display. You can select one channel from 01 to 16 as the navigate channel. Since this setting lets you use the data on any channel of commercially available SMF data to light on the on-screen keyboard guide, you can analyze how different parts of an arrangement are played.

- 1 Press the **SETTING** button until the **NAVIGATE CHANNEL** screen appears.



04 Navi. Ch

- 2 Use the **[+]**, **[-]**, and the number buttons **[0]** through **[9]** to change the channel number.

Example: To specify channel 2

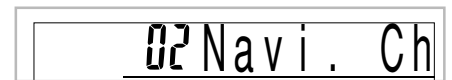

02 Navi. Ch

To turn off specific sounds before playing back tune data that is being received

<<Navigate channel on/off>>

- 1 While playing tune data, press the **RIGHT** button.
 - This cuts the sound of the navigate channel, but on-screen keyboard guide keys continue to light in accordance with the channel's data as it is received. Press **RIGHT** button again to turn the channel back on.

<<Next lower channel from navigate channel on/off>>

- 1 While playing tune data, press the **LEFT** button.
 - This cuts the sound of the channel whose number is one less than the navigate channel, but on-screen keyboard guide keys continue to light in accordance with the channel's data as it is received. Press **LEFT** button again to turn the channel back on.

Example: If the navigate channel is channel 4, the above operation turns off channel 3.

LOCAL CONTROL (Default: On)

oFF: Anything played on the keyboard is output as a message from the USB port, without being sounded by the internal sound source.

- Note that no sound is produced by the keyboard if **LOCAL CONTROL** is turned off and no external device is connected.

- 1 Press the **SETTING** button until the **LOCAL CONTROL** screen appears.

Example: When **LOCAL CONTROL** is on

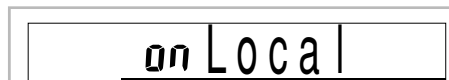

on Local

- 2 Use the **[+]** and **[-]** or **[0]** and **[1]** buttons to turn the setting on and off.

Example: To turn **LOCAL CONTROL** off

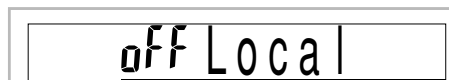

off Local

Troubleshooting

Problem	Possible Cause	Action	See page
No keyboard Sound	<ol style="list-style-type: none"> 1. Power supply problem. 2. Power is not turned on. 3. Volume setting is too low. 4. The POWER/MODE switch is in the CASIO CHORD or FINGERED position. 	<ol style="list-style-type: none"> 1. Correctly attach the AC adaptor, make sure that batteries poles (+/-) are facing correctly, and check to make sure that batteries are not dead. 2. Set the POWER/MODE switch to the NORMAL position. 3. Use the MAIN VOLUME slider to increase volume. 4. Normal play is not possible on the accompaniment keyboard while the POWER/MODE switch is set to CASIO CHORD or FINGERED. Change the POWER/MODE switch setting to NORMAL. 	<p>Pages E-12, 13</p> <p>Page E-15</p> <p>Page E-15</p> <p>Page E-15</p>
Any of the following symptoms while using battery power.	Low battery power	Replace the batteries with a set of new ones or use the AC adaptor.	Pages E-12, 13
<div style="border: 1px solid black; padding: 10px;"> <ul style="list-style-type: none"> • Dim power supply indicator • Instrument does not turn on • Dim, difficult to read display • Abnormally low speaker/headphone volume • Distortion of sound output • Occasional interruption of sound when playing at high volumes • Sudden power failure when playing at high volumes <ul style="list-style-type: none"> • Dimming of the display when playing at high volume • Continued sound output even after you release a key • A totally different tone may sound • Abnormal rhythm pattern and demo tune play • Abnormally low microphone volume • Distortion of microphone input • Dim power supply indicator when a microphone is used • Sudden power failure when using the microphone </div>			
Auto Accompaniment does not sound.	Accompaniment volume is set to 00.	Use the SETTING button to increase the volume.	Page E-28
On-screen keyboard guide keys stay on.	Keyboard is waiting for play of the correct note during Step 1 or Step 2 play.	<ol style="list-style-type: none"> 1. Press the lit key to continue with Step 1 or Step 2 play. 2. Press the START/STOP button to quit Step 1 or Step 2 play. 	<p>Pages E-25, 26</p> <p>Pages E-25, 26</p>
When playing with another instrument, keys or tunings do not match.	Transpose or tuning is set to a value other than 00.	Use the SETTING button to display the applicable setting screens and set both transpose and tuning to 00.	Pages E-28, 29
Static noise when a microphone is connected.	<ol style="list-style-type: none"> 1. Use of a microphone that is a different from the type that is recommended. 2. Use of the microphone in the vicinity of fluorescent lighting. 	<ol style="list-style-type: none"> 1. Use a recommended type microphone. 2. Move the microphone away from source of the static. 	<p>Page E-16</p> <p>Page E-16</p>
No microphone sound	<ol style="list-style-type: none"> 1. Microphone volume setting is too low. 2. Microphone ON/OFF switch is set to OFF. 	<ol style="list-style-type: none"> 1. Increase the microphone volume setting. 2. Change the microphone ON/OFF switch setting to ON. 	<p>Page E-16</p> <p>Page E-16</p>
After transferring song data from my computer, playback stops part way through.	Digital noise from the USB cable or power cord caused data communication between your computer and keyboard to be interrupted.	<p>Stop playback, disconnect the USB cable from and then reconnect it to the keyboard's USB port, and then try playing back the tune again.</p> <p>If this does not correct the problem, exit the MIDI software you are using, and then disconnect the USB cable from and then reconnect it to the keyboard's USB port. Next, restart your MIDI software and try playback again.</p>	Page E-31
A tone's quality and volume sounds slightly different depending where it is played on the keyboard.	<p>This is an unavoidable result of the digital sampling process,* and does not indicate malfunction.</p> <p>* Multiple digital samples are taken for the low range, middle range, and high range of the original musical instrument. Because of this, there may be a very slight difference in tonal quality and volume between sample ranges.</p>		

Specifications

Model:	CTK-720
Keyboard:	61 standard-size keys, 5 octaves
Tones:	242 (113 panel tones + 128 General MIDI tones + 1 drum set)
Polyphony:	32 notes maximum (16 for certain tones)
Main Volume:	Adjustable
Auto Accompaniment Rhythm Patterns: Chords: Rhythm Controller:	100 2 fingering methods (CASIO CHORD, FINGERED) START/STOP, SYNCHRO, FILL-IN
3-step Lesson: Playback: Lesson Part: Evaluation Mode: Voice Fingering Guide:	3 lessons (Step 1, 2, 3) Repeat play of a single tune Left hand, right hand Scoring On/Off
Song Bank, Piano Bank Number of Tunes: Controllers:	Song Bank: 50, Piano Bank: 50 START/STOP
Display Name display: Tempo: Chord: Fingering: Staff: Keyboard:	TONE, RHYTHM, SONG BANK, PIANO BANK name/number, keyboard settings name/value Tempo value, metronome, synchro standby Chord name, Chord form Fingering indicators, parts 5 octaves with sharp and flat indications, pedal symbol, octave symbol 5 octaves
Other Functions Tempo: Transpose: Tuning: Accompaniment/ Song Bank Volume:	Variable (216 steps, ♩ = 40 to 255) 25 steps (-12 semitones to +12 semitones) Variable (A4 = approximately 440Hz ±50 cents) Variable (100 steps, 0 to 99)
Terminals USB port: Sustain Terminal: Phones/Output Terminal: Power Supply Terminal: Microphone In:	TYPE B Standard jack Stereo standard jack Output Impedance: 100Ω Output Voltage: 4V (RMS) MAX 9V DC Standard jack (with microphone volume slider) Input impedance: 2kΩ Input sensitivity: 10mV
Power Supply: Batteries: Battery Life: AC Adaptor: Auto Power Off:	Dual power supply system 6 AA-size batteries Approximately 4 hours continuous operation on alkaline batteries Approximately 2 hours continuous operation on manganese batteries AD-5 Turns power off approximately 6 minutes after last key operation. Enabled under battery power only, can be disabled manually.
Speaker Output:	2.0W + 2.0W
Power Consumption:	9V ∴ 7.7W
Dimensions:	95.6 x 35.6 x 13.3 cm (37 ¹¹ / ₁₆ × 14 ¹ / ₁₆ × 5 ¹ / ₄ inch)
Weight:	Approximately 4.0kg (8.8lbs) (without batteries)

Tone List/Lista de sonidos

- ① : No./Nº
- ② : Bank Select MSB/MSB de selección de banco

- ② : Tone Name/Nombre de sonido
- ③ : Maximum Polyphony/Polifonía máxima
- ④ : Program Change/Cambio de programa
- ⑤ : Range Type/Tipo de gama

①	②	③	④	⑤	⑥
000	PIANO	000	002	16	A
001	STEREO GRAND PIANO	000	004	32	A
002	GRAND PIANO	001	002	32	A
003	BRIGHT PIANO	000	001	32	A
004	MELLOW PIANO	001	001	32	A
005	DANCE PIANO	003	002	16	A
006	HONKY-TONK	003	008	16	A
007	OCTAVE PIANO	002	002	16	A
008	ELEC.GRAND PIANO	004	002	32	A
009	ELEC.PIANO	005	002	32	A
010	MODERN E.PIANO	004	001	16	A
011	CHORUS EP	004	008	16	A
012	SOFT E.PIANO	006	002	32	A
013	HARPSICHORD	006	008	16	A
014	COUPLED HARPSICHORD	007	002	32	A
	CHROMATIC PERC				
015	CELESTA	008	002	32	A
016	GLOCKENSPIEL	009	002	32	B
017	VIBRAPHONE	011	002	32	A
018	MARIMBA	012	002	32	A
	ORGAN				
019	DRAWBAR ORGAN 1	016	002	16	A
020	DRAWBAR ORGAN 2	016	001	16	A
021	PERC.ORGAN 1	017	002	16	A
022	PERC.ORGAN 2	017	001	16	A
023	ELEC.ORGAN	016	008	16	A
024	ROCK ORGAN	018	002	16	A
025	CHURCH ORGAN	019	002	16	A
026	CHAPEL ORGAN	019	008	32	A
027	ACCORDION	021	002	16	A
028	OCTAVE ACCORDION	021	008	16	A
029	BANDONEON	023	002	16	A
030	HARMONICA	022	002	32	A
	GUITAR				
031	NYLON STR.GUITAR	024	002	32	C
032	STEEL STR.GUITAR	025	002	32	C
033	12 STR.GUITAR	025	008	16	C
034	JAZZ GUITAR	026	002	32	C
035	CLEAN GUITAR	027	002	32	C
036	ELEC.GUITAR	027	001	16	C
037	MUTE GUITAR	028	002	32	C
038	OVERDRIVE GT	029	002	32	C
039	DISTORTION GT	030	002	32	C
040	FEEDBACK GT	031	008	16	C
	BASS				
041	ACOUSTIC BASS	032	002	32	C
042	RIDE BASS	032	008	16	C
043	FINGERED BASS	033	002	32	C
044	PICKED BASS	034	002	32	C
045	FRETLESS BASS	035	002	32	C
046	SLAP BASS	036	002	32	C
047	SYNTH-BASS 1	038	002	32	C

①	②	③	④	⑤	⑥
048	SYNTH-BASS 2	039	002	32	C
	STRORCHESTRA				
049	VIOLIN	040	002	32	A
050	SLOW VIOLIN	040	008	32	A
051	CELLO	042	002	32	C
052	HARP	046	002	32	A
	ENSEMBLE				
053	STRINGS	048	002	32	A
054	SLOW STRINGS	049	002	32	A
055	CHAMBER	048	001	16	A
056	SYNTH-STRINGS 1	050	002	32	A
057	SYNTH-STRINGS 2	051	002	32	A
058	CHOIRS	052	002	32	A
059	VOICE DOO	053	002	32	A
060	SYNTH-VOICE	054	002	16	A
	BRASS				
061	TRUMPET	056	002	32	A
062	TROMBONE	057	002	32	C
063	TUBA	058	002	32	C
064	MUTE TRUMPET	059	002	32	A
065	FRENCH HORN	060	002	16	C
066	BRASS SFZ	061	002	32	A
067	BRASS	061	008	16	A
068	SYNTH-BRASS 1	062	002	32	A
069	SYNTH-BRASS 2	063	002	16	A
	REED				
070	SOPRANO SAX	064	002	32	A
071	ALTO SAX	065	002	32	C
072	TENOR SAX	066	002	32	C
073	BARITONE SAX	067	002	32	C
074	OBOE	068	002	32	A
075	CLARINET	071	002	32	A
	PIPE				
076	PICCOLO	072	002	32	B
077	FLUTE	073	002	32	A
078	MELLOW FLUTE	073	008	32	A
079	RECORDER	074	002	32	A
080	PAN FLUTE	075	002	32	A
081	OCARINA	079	002	32	A
	SYNTH-LEAD				
082	SQUARE LEAD	080	002	16	A
083	SAW LEAD	081	002	16	A
084	MELLOW SAW LEAD	081	008	16	A
085	SINE LEAD	080	008	32	A
086	CALLIOPE	082	002	16	A
087	VOICE LEAD	085	002	16	A
088	BASS+LEAD	087	002	16	A
	SYNTH-PAD				
089	FANTASY	088	002	16	A
090	WARM PAD	089	002	16	A
091	POLYSYNTH	090	002	16	A
092	BOWED PAD	092	002	16	A
093	HALO PAD	094	002	16	A

1	2	3	4	5	6
150	GM SLAP BASS 2	037	000	32	A
151	GM SYNTH-BASS 1	038	000	32	A
152	GM SYNTH-BASS 2	039	000	32	A
153	GM VIOLIN	040	000	32	A
154	GM VIOLA	041	000	32	A
155	GM CELLO	042	000	32	A
156	GM CONTRABASS	043	000	32	A
157	GM TREMOLO STRINGS	044	000	32	A
158	GM PIZZICATO	045	000	32	A
159	GM HARP	046	000	32	A
160	GM TIMPANI	047	000	32	A
161	GM STRINGS 1	048	000	32	A
162	GM STRINGS 2	049	000	32	A
163	GM SYNTH-STRINGS 1	050	000	32	A
164	GM SYNTH-STRINGS 2	051	000	32	A
165	GM CHOIR/AHHS	052	000	32	A
166	GM VOICE DOO	053	000	32	A
167	GM SYNTH-VOICE	054	000	16	A
168	GM ORCHESTRA HIT	055	000	16	A
169	GM TRUMPET	056	000	32	A
170	GM TROMBONE	057	000	32	A
171	GM TUBA	058	000	32	A
172	GM MUTE TRUMPET	059	000	32	A
173	GM FRENCH HORN	060	000	16	A
174	GM BRASS	061	000	32	A
175	GM SYNTH-BRASS 1	062	000	32	A
176	GM SYNTH-BRASS 2	063	000	16	A
177	GM SOPRANO SAX	064	000	32	A
178	GM ALTO SAX	065	000	32	A
179	GM TENOR SAX	066	000	32	A
180	GM BARITONE SAX	067	000	32	A
181	GM OBOE	068	000	32	A
182	GM ENGLISH HORN	069	000	32	A
183	GM BASSOON	070	000	32	A
184	GM CLARINET	071	000	32	A
185	GM PICCOLO	072	000	32	A
186	GM FLUTE	073	000	32	A
187	GM RECORDER	074	000	32	A
188	GM PAN FLUTE	075	000	32	A
189	GM BOTTLE BLOW	076	000	16	A
190	GM SHAKUHACHI	077	000	16	A
191	GM WHISTLE	078	000	32	A
192	GM OCARINA	079	000	32	A
193	GM SQUARE LEAD	080	000	16	A
194	GM SAWTOOTH LEAD	081	000	16	A
195	GM CALLLOPE	082	000	16	A
196	GM CHIFF LEAD	083	000	16	A
197	GM CHARANG	084	000	16	A
198	GM VOICE LEAD	085	000	16	A
199	GM FIFTH LEAD	086	000	16	A
200	GM BASS+LEAD	087	000	16	A
201	GM FANTASY	088	000	16	A
202	GM WARM PAD	089	000	16	A
203	GM POLYSYNTH	090	000	16	A
204	GM SPACE CHOIR	091	000	16	A
205	GM BOWED GLASS	092	000	16	A
206	GM METAL PAD	093	000	16	A
207	GM HALO PAD	094	000	16	A
208	GM SWEEP PAD	095	000	16	A

1	2	3	4	5	6
094	SOUND TRACK	097	002	16	A
095	ATMOSPHERE	099	002	16	A
096	BRIGHTNESS	100	002	16	A
097	ECHO PAD	102	002	16	A
098	LAYER				
098	STRINGS PIANO	000	008	16	A
099	PIANO PAD	001	008	16	A
100	E.PIANO PAD 1	005	008	16	A
101	E.PIANO PAD 2	004	004	16	A
102	SYNTH-STR. E.PIANO	005	004	16	A
103	CLAVI & DRAWBAR	007	008	16	A
104	GLOCKENSPIEL PAD	009	008	16	B
105	ORGAN & HARPSICHORD	019	004	16	A
106	DIST.GT & BASS	030	008	16	C
107	KOTO PAD	107	008	16	A
108	SPLIT				
108	BASS/PIANO	120	002	32	E
109	BASS/E.PIANO	121	002	16	E
110	BASS/VIB	122	002	32	E
111	BASS/NYLON STR. GT	123	002	32	E
112	STRINGS/PIANO	124	002	32	E
113	GM TONES				
113	GM PIANO 1	000	000	32	A
114	GM PIANO 2	001	000	32	A
115	GM PIANO 3	002	000	16	A
116	GM HONKY-TONK	003	000	16	A
117	GM E.PIANO 1	004	000	32	A
118	GM E.PIANO 2	005	000	32	A
119	GM HARPSICHORD	006	000	32	A
120	GM CLAVI	007	000	32	A
121	GM CELESTA	008	000	32	A
122	GM GLOCKENSPIEL	009	000	32	A
123	GM MUSIC BOX	010	000	16	A
124	GM VIBRAPHONE	011	000	32	A
125	GM MARIMBA	012	000	32	A
126	GM XYLOPHONE	013	000	32	A
127	GM TUBULAR BELL	014	000	32	A
128	GM DULCIMER	015	000	16	A
129	GM ORGAN 1	016	000	16	A
130	GM ORGAN 2	017	000	16	A
131	GM ORGAN 3	018	000	16	A
132	GM PIPE ORGAN	019	000	16	A
133	GM REED ORGAN	020	000	32	A
134	GM ACCORDION	021	000	16	A
135	GM HARMONICA	022	000	32	A
136	GM BANDONEON	023	000	16	A
137	GM NYLON STR.GUITAR	024	000	32	A
138	GM STEEL STR.GUITAR	025	000	32	A
139	GM JAZZ GUITAR	026	000	32	A
140	GM CLEAN GUITAR	027	000	32	A
141	GM MUTE GUITAR	028	000	32	A
142	GM OVERDRIVE GT	029	000	32	A
143	GM DISTORTION GT	030	000	32	A
144	GM GT HARMONICS	031	000	32	A
145	GM ACOUSTIC BASS	032	000	32	A
146	GM FINGERED BASS	033	000	32	A
147	GM PICKED BASS	034	000	32	A
148	GM FRETLESS BASS	035	000	32	A
149	GM SLAP BASS 1	036	000	32	A



NOTE

- The meaning of each range type is described below.

NOTA

- El significado de cada tipo de gama se describe debajo.

1	2	3	4	5	6
209	GM RAIN DROP	096	000	16	A
210	GM SOUND TRACK	097	000	16	A
211	GM CRYSTAL	098	000	16	A
212	GM ATMOSPHERE	099	000	16	A
213	GM BRIGHTNESS	100	000	16	A
214	GM GOBLINS	101	000	16	A
215	GM ECHOES	102	000	16	A
216	GM SF	103	000	16	A
217	GM SITAR	104	000	16	A
218	GM BANJO	105	000	32	A
219	GM SHAMISEN	106	000	32	A
220	GM KOTO	107	000	32	A
221	GM THUMB PIANO	108	000	32	A
222	GM BAGPIPE	109	000	16	A
223	GM FIDDLE	110	000	32	A
224	GM SHANAI	111	000	32	A
225	GM TINKLE BELL	112	000	32	A
226	GM AGOGO	113	000	32	A
227	GM STEEL DRUMS	114	000	16	A
228	GM WOOD BLOCK	115	000	32	D
229	GM TAIKO	116	000	32	D
230	GM MELODIC TOM	117	000	32	D
231	GM SYNTH-DRUM	118	000	16	D
232	GM REVERSE CYMBAL	119	000	32	D
233	GM GT FRET NOISE	120	000	32	A
234	GM BREATH NOISE	121	000	32	A
235	GM SEASHORE	122	000	16	D
236	GM BIRD	123	000	16	D
237	GM TELEPHONE	124	000	32	D
238	GM HELICOPTER	125	000	32	D
239	GM APPLAUSE	126	000	16	D
240	GM GUNSHOT	127	000	32	D
	DRUM SET				
241	DRUM SET	000	120	32	D

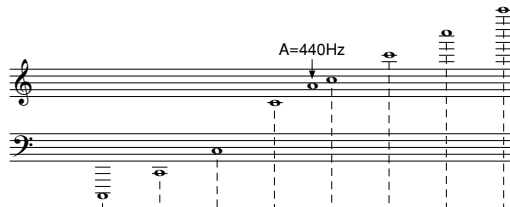

Range Type/Tipo de gama	C-1	C0	C1	C2	C3	C4	C5	C6	C7	G7	C8	C9	G9
A (Standard type) (Tipo estándar)													
B ("016 GLOCKENSPIEL"/ "076 PICCOLO"/ "104 GLOCKENSPIEL PAD") ("016 GLOCKENSPIEL"/ "076 PICCOLO"/ "104 GLOCKENSPIEL PAD")													
C (Low pitch instruments) (Instrumentos de altura tonal baja)													
D (Sound Effect) (Efecto de sonido)	No scale for tones. Sin escala para los sonidos.												
E (SPLIT) (División)	Scale changes in accordance with tone. La escala cambia de acuerdo con el sonido.												

- aKeyboard range
.....Gama del teclado
- bAvailable range (using transpose or message receive)
.....Gama disponible (usando la transposición o recepción de mensajes)
- cNotes in these ranges are produced by playing the notes in range b that are in the nearest octave as the result of transpose and message receive operations.
.....Las notas en estas gamas se producen ejecutando las notas en la gama b que se encuentre en la octava más cercana como resultado de las operaciones de transposición y recepción de mensajes.

Percussion Instrument List

Lista de instrumentos de percusión

- DRUM SET (tone 241) assigns percussion sound to the keyboard as illustrated below. The sound assigned to each key are indicated above the keyboard.
- DRUM SET (sonido 241) asigna sonidos de percusión al teclado como se ilustra debajo. Los sonidos asignados a cada tecla se indican sobre el teclado.

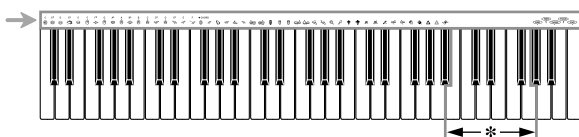

- * No sound is produced when the keys in this range are pressed.
- * Cuando se presionan las teclas en esta gama no se produce ningún sonido.

STANDARD KICK	CRASH CYMBAL 1	MUTE HIGH CONGA	CLAVES
SIDE STICK	HIGH TOM 1	OPEN HIGH CONGA	HIGH WOOD BLOCK
STANDARD SNARE 1	RIDE CYMBAL 1	LOW CONGA	LOW WOOD BLOCK
HAND CLAP	CHINESE CYMBAL	HIGH TIMBALE	MUTE CUICA
STANDARD SNARE 2	RIDE BELL	LOW TIMBALE	OPEN CUICA
LOW TOM 2	TAMBOURINE	HIGH AGOGO	MUTE TRIANGLE
CLOSED HI-HAT	SPLASH CYMBAL	LOW AGOGO	OPEN TRIANGLE
LOW TOM 1	COWBELL	CABASA	SHAKER
PEDAL HI-HAT	CRASH CYMBAL 2	MARACAS	COUNT VOICE 1
MID TOM 2	VIBRA-SLAP	SHORT HIGH WHISTLE	COUNT VOICE 2
OPEN HI-HAT	RIDE CYMBAL 2	LONG LOW WHISTLE	COUNT VOICE 3
MID TOM 1	HIGH BONGO	SHORT GUIRO	COUNT VOICE 4
HIGH TOM 2	LOW BONGO	LONG GUIRO	COUNT VOICE 5

Fingered Chord Chart

Cuadros de acordes Fingered

This table shows the left-hand fingerings (including inverted forms) for a number of often-used chords. These fingering indications also appear on the keyboard's display. Chords marked with asterisk (*) cannot be played in the Fingered Mode on this keyboard.

Esta tabla muestra las digitaciones (incluyendo las formas invertidas) para varios de los acordes más a menudo usados. Estas indicaciones de digitación también aparecen sobre la presentación del teclado.

En este teclado, los acordes marcados con asterisco (*) no pueden ejecutarse en el modo de digitación.

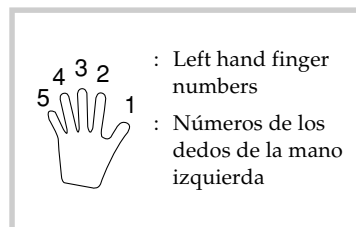

Chord Root Type	M	m	7	m7	dim7	M7	m7-5	dim
C	[5, 3, 1]	[5, 3, 1]	[5, 3, 2, 1]	[5, 3, 2, 1]	[5, 3, 2, 1]	[5, 3, 2, 1]	[5, 3, 2, 1]	[5, 3, 2]
C# (Db)	[5, 3, 1]	[5, 3, 1]	[5, 3, 2, 1]	[5, 3, 2, 1]	[5, 3, 2, 1]	[5, 3, 2, 1]	[5, 3, 2, 1]	[5, 3, 2]
D	[5, 3, 1]	[5, 3, 1]	[5, 3, 2, 1]	[5, 3, 2, 1]	[5, 3, 2, 1]	[5, 3, 2, 1]	[5, 3, 2, 1]	[5, 3, 2]
Eb (D#)	[5, 3, 1]	[5, 3, 1]	[5, 3, 2, 1]	[5, 3, 2, 1]	[5, 3, 2, 1]	[5, 3, 2, 1]	[5, 3, 2, 1]	[5, 3, 2]
E	[5, 3, 1]	[5, 3, 1]	[5, 3, 2, 1]	[5, 3, 2, 1]	[5, 3, 2, 1]	[5, 3, 2, 1]	[5, 3, 2, 1]	[5, 3, 2]
F	[5, 3, 1]	[5, 3, 1]	[5, 3, 2, 1]	[5, 3, 2, 1]	[5, 3, 2, 1]	[5, 3, 2, 1]	[5, 3, 2, 1]	[5, 3, 2]
F# (Gb)	[5, 3, 1]	[5, 3, 1]	[5, 3, 2, 1]	[5, 3, 2, 1]	[5, 3, 2, 1]	[5, 3, 2, 1]	[5, 3, 2, 1]	[5, 3, 2]
G	[5, 3, 1]	[5, 3, 1]	[5, 3, 2, 1]	[5, 3, 2, 1]	[5, 3, 2, 1]	[5, 4, 2, 1]	[5, 3, 2, 1]	[5, 3, 2]
Ab (G#)	[5, 3, 1]	[5, 3, 1]	[5, 4, 2, 1]	[5, 4, 2, 1]	[5, 3, 2, 1]	[5, 4, 2, 1]	[5, 4, 2, 1]	[5, 3, 2]
A	[5, 3, 1]	[5, 3, 1]	[5, 4, 2, 1]	[5, 4, 2, 1]	*	[5, 4, 2, 1]	[5, 4, 2, 1]	[5, 3, 2]
Bb (A#)	[5, 3, 1]	[5, 3, 1]	[5, 4, 2, 1]	[5, 4, 2, 1]	*	[5, 4, 2, 1]	[5, 4, 2, 1]	[5, 3, 2]
B	[5, 2, 1]	[5, 2, 1]	[5, 3, 2, 1]	[5, 3, 2, 1]	*	[5, 3, 2, 1]	[5, 4, 2, 1]	[5, 3, 2]

Chord Root Type	aug	sus4	7 sus4	m add9	m M7	7-5	add9
C	[5, 3, 1]	[5, 2, 1]	[5, 3, 2, 1]	[4, 3, 2, 1]	[5, 3, 2, 1]	[5, 3, 2, 1]	[4, 3, 2, 1]
C# (Db)	[5, 3, 1]	[5, 2, 1]	[5, 3, 2, 1]	[4, 3, 2, 1]	[5, 3, 2, 1]	[5, 3, 2, 1]	[4, 3, 2, 1]
D	[5, 3, 1]	[5, 2, 1]	[5, 3, 2, 1]	[4, 3, 2, 1]	[5, 3, 2, 1]	[5, 3, 2, 1]	[4, 3, 2, 1]
Eb (D#)	[5, 3, 1]	[5, 2, 1]	[5, 3, 2, 1]	[4, 3, 2, 1]	[5, 3, 2, 1]	[5, 3, 2, 1]	[4, 3, 2, 1]
E	[5, 3, 1]	[5, 2, 1]	[5, 3, 2, 1]	[4, 3, 2, 1]	[5, 3, 2, 1]	[5, 3, 2, 1]	[4, 3, 2, 1]
F	[5, 3, 1]	[5, 2, 1]	[5, 3, 2, 1]	[4, 3, 2, 1]	[5, 3, 2, 1]	[5, 3, 2, 1]	[4, 3, 2, 1]
F# (Gb)	[5, 3, 1]	[5, 2, 1]	[5, 3, 2, 1]	[4, 3, 2, 1]	[5, 3, 2, 1]	[5, 3, 2, 1]	[4, 3, 2, 1]
G	[5, 3, 1]	[5, 2, 1]	[5, 3, 2, 1]	[4, 3, 2, 1]	[5, 4, 2, 1]	[5, 3, 2, 1]	[4, 3, 2, 1]
Ab (G#)	[5, 3, 1]	[5, 2, 1]	[5, 4, 2, 1]	[4, 3, 2, 1]	[5, 4, 2, 1]	[5, 4, 2, 1]	[4, 3, 2, 1]
A	[5, 3, 1]	[5, 2, 1]	[5, 4, 2, 1]	[4, 3, 2, 1]	[5, 4, 2, 1]	[5, 4, 2, 1]	[4, 3, 2, 1]
Bb (A#)	*	[5, 2, 1]	[5, 4, 2, 1]	[4, 3, 2, 1]	[5, 4, 2, 1]	[5, 4, 2, 1]	[4, 3, 2, 1]
B	*	[5, 2, 1]	[5, 3, 2, 1]	[5, 3, 2, 1]	[5, 3, 2, 1]	[4, 3, 2, 1]	[5, 3, 2, 1]

Rhythm List**Lista de ritmos**

POPS I	
00	8 BEAT 1
01	8 BEAT 2
02	POP 1
03	POP 2
04	SOUL BALLAD 1
05	POP BALLAD 1
06	POP SHUFFLE 1
07	SOUL
08	OFF BEAT
09	POP BALLAD 2
POPS II	
10	FOLKIE POP 1
11	SOUL BALLAD 2
12	LITE POP 1
13	CLUB POP 1
14	8 BEAT POP
15	16 BEAT 1
16	DANCE POP 1
17	POP BALLAD 3
18	DANCE POP 2
19	16 BEAT 2
DANCE/FUNK	
20	TECHNO
21	TRANCE 1
22	RAP 1
23	DISCO 1
24	FUNK 1
25	FUNK 2
26	DISCO 2
ROCK	
27	LATIN ROCK
28	SHUFFLE ROCK
29	POP ROCK 1
30	ROCK WALTZ 1
31	SLOW ROCK
32	50'S ROCK 1
33	60'S ROCK 1
34	TWIST
35	NEW ORLNS R&R
36	ROCK 1
37	SOFT ROCK 1

JAZZ	
38	JAZZ COMBO 1
39	JAZZ COMBO 2
40	BIG BAND
41	SWING
42	SLOW SWING
43	JAZZ WALTZ 1
44	FOX TROT
EUROPEAN	
45	POP POLKA
46	POLKA
47	MARCH 1
48	WALTZ 1
49	WALTZ 2
50	SLOW WALTZ
51	TANGO 1
LATIN/VARIOUS	
52	REGGAE POP
53	BOSSA NOVA 1
54	SAMBA 1
55	REGGAE
56	MAMBO
57	SKA
58	MERENGUE
59	RUMBA CATALANA
60	BOSSA NOVA 2
61	SAMBA 2
62	FOLKLORE
63	COUNTRY
64	TOWN SHIP
65	SLOW GOSPEL
66	BAROQUE
67	TEX-MEX
68	FAST GOSPEL
69	NEW AGE
WITHOUT DRUMS	
70	POP BALLAD 4
71	POP SHUFFLE 2
72	ROCK WALTZ 2
73	FOLKIE POP 2
74	TANGO 2

DRUM & BASS	
75	POP BALLAD 5
76	LITE POP 2
77	POP ROCK 2
78	CLUB POP 2
79	16 BEAT 3
80	ROCK WALTZ 3
81	SOFT ROCK 2
82	50'S ROCK 2
83	ROCK 2
84	60'S SOUL 2
85	TRANCE 2
86	RAP 2
87	DISCO 3
88	FUNK 3
89	JAZZ COMBO 3
90	JAZZ WALTZ 2
91	TANGO 3
92	BOSSA NOVA 3
93	SAMBA 3
94	MARCH 2
METRÓNOME	
95	0 BEAT
96	2 BEAT
97	3 BEAT
98	4 BEAT
99	6 BEAT

Song List/Lista de canciones

SONG BANK List

Lista SONG BANK

- 00 CAN YOU FEEL THE LOVE TONIGHT
("LION KING" THEME)
- 01 HAPPY BIRTHDAY TO YOU
- 02 WE WISH YOU A MERRY CHRISTMAS
- 03 JINGLE BELLS
- 04 SILENT NIGHT
- 05 JOY TO THE WORLD
- 06 O CHRISTMAS TREE
- 07 WHEN THE SAINTS GO MARCHING IN
- 08 GREENSLEEVES
- 09 AMAZING GRACE
- 10 AULD LANG SYNE
- 11 TWINKLE TWINKLE LITTLE STAR
- 12 LIGHTLY ROW
- 13 UNDER THE SPREADING CHESTNUT TREE
- 14 COME BIRDS
- 15 THE MUFFIN MAN
- 16 LONG LONG AGO
- 17 DID YOU EVER SEE A LASSIE?
- 18 LONDON BRIDGE
- 19 ON THE BRIDGE OF AVIGNON
- 20 SIPPIN' CIDER THROUGH A STRAW
- 21 GRANDFATHER'S CLOCK
- 22 MICHAEL ROW THE BOAT ASHORE
- 23 ANNIE LAURIE
- 24 MY BONNIE

- 25 IF YOU'RE HAPPY AND YOU KNOW IT,
CLAP YOUR HANDS
- 26 MY DARLING CLEMENTINE
- 27 HOME SWEET HOME
- 28 J'AI PERDU LE DO DE MA CLARINETTE
- 29 I'VE BEEN WORKING ON THE RAILROAD
- 30 LITTLE BROWN JUG
- 31 AURA LEE
- 32 HOUSE OF THE RISING SUN
- 33 SHE WORE A YELLOW RIBBON
- 34 CAMPTOWN RACES
- 35 SWANEE RIVER (OLD FOLKS AT HOME)
- 36 YANKEE DOODLE
- 37 TURKEY IN THE STRAW
- 38 MY OLD KENTUCKY HOME
- 39 HOME ON THE RANGE
- 40 ALOHA OE
- 41 HOLDIRIDIA
- 42 LA PALOMA
- 43 SANTA LUCIA
- 44 TROIKA
- 45 WALTZING MATILDA
- 46 AJO MAMMA
- 47 LA DONNA É MOBILE FROM "RIGOLETTE"
- 48 CHANSON DU TOREADOR FROM "CARMEN"
- 49 HABANERA FROM "CARMEN"

PIANO BANK List

Lista PIANO BANK

- 00 FÜR ELISE
- 01 SONATA op.13 "PATHÉTIQUE" 2nd Mov.
- 02 SONATA op.27 no.2 "MOONLIGHT" 1st Mov.
- 03 ODE TO JOY
- 04 ETUDE op.10 no.3 "CHANSON DE L'ADIEU"
- 05 PRELUDE op.28 no.7 (CHOPIN)
- 06 VALSE op.64 no.1 "PETIT CHIEN"
- 07 HEIDENRÖSLEIN
- 08 FRÖHLICHER LANDMANN
- 09 CANON (PACHELBEL)
- 10 MINUET (J.S.BACH)
- 11 MUSETTE (J.S.BACH)
- 12 JESUS BLEIBET MEINE FREUDE
- 13 GAVOTTE (GOSSEC)
- 14 SERENADE FROM "EINE KLEINE NACHTMUSIK"
- 15 SONATA K.331 1st Mov. "THEME"
- 16 TURKISH MARCH (MOZART)
- 17 HUNGARIAN DANCES no.5
- 18 WEDDING MARCH FROM
"MIDSUMMER NIGHT'S DREAM"
- 19 LIEBESTRÄUME no.3
- 20 BRINDISI FROM "LA TRAVIATA"
- 21 GOING HOME FROM "FROM THE NEW WORLD"
- 22 JE TE VEUX
- 23 THE ENTERTAINER
- 24 AMERICAN PATROL

- 25 CHOPSTICKS
 - 26 MARY HAD A LITTLE LAMB
 - 27 DECK THE HALL
 - 28 SWING LOW, SWEET CHARIOT
 - 29 THE FARMER IN THE DELL
 - 30 ON TOP OF OLD SMOKEY
 - 31 DOWN IN THE VALLEY
 - 32 OH! SUSANNA
 - 33 WHEN JOHNNY COMES MARCHING HOME
 - 34 RED RIVER VALLEY
 - 35 JAMAICA FAREWELL
 - 36 LA CUCARACHA
 - 37 CIELITO LINDO
 - 38 BEAUTIFUL DREAMER
 - 39 DANNY BOY
- BEYER VORSCHULE IM KLAVIERSPIEL Opus 101**
- 40 No.5
 - 41 No.6
 - 42 No.8
 - 43 No.11
 - 44 No.12
 - 45 No.18
 - 46 No.20
 - 47 No.35
 - 48 No.48
 - 49 No.60

Model **CTK-720**

Version: 1.0

MIDI messages that can be sent and received using the USB port
Los mensajes MIDI pueden enviarse y recibirse usando el puerto USB

Function ...	Transmitted	Recognized	Remarks
Basic Channel Default Changed	1 1-16	1-16 1-16	
Mode Default Messages Altered	Mode 3 X *****	Mode 3 X *****	
Note Number True voice	36-96 *****	0-127 12-108 *1	*1: Depends on tone *1: Depende en el sonido
Velocity Note ON Note OFF	X 9nH V = 100 X 9nH V = 0	O 9nH V = 1-127 X 9nH V = 0,8nH V = *2	*2 = no relation *2 = sin relación
After Touch Key's Ch's	X X	X X	
Pitch Bender	X	O	
Control Change 0, 32 1 6, 38 7 10 11	O X X X X X	O O O O O O	Bank select Modulation Data entry Volume Pan Expression

64 100, 101 120 121	O X X X	O O *3 O O	Hold1 RPN LSB, MSB All sound off Reset all controller
Program Change : True #	O 0-127 *****	O 0-127 *****	
System Exclusive	X	O *4	
System Common : Song Pos : Song Sel : Tune	X X X	X X X	
System Real Time : Clock : Commands	X X	X X	
Aux Messages : Local ON/OFF : All notes OFF : Active Sense : Reset	X X X X	X O X X	
Remarks	*3 FINE TUNE, COARSE TUNE receive, and PITCH BEND SENSE, RPN Null receive. *3 FINE TUNE, recepción COARSE TUNE, y PITCH BEND SENSE, recepción RPN Null. *4 GM on/off GM ON : [F0] [7E] [7F] [09] [01] [F7] GM OFF : [F0] [7E] [7F] [09] [02] [F7] *4 Activación/desactivación GM GM ON: [F0] [7E] [7F] [09] [01] [F7] GM OFF: [F0] [7E] [7F] [09] [02] [F7]		

Mode 1 : OMNI ON, POLY
Mode 3 : OMNI OFF, POLY

Mode 2 : OMNI ON, MONO
Mode 4 : OMNI OFF, MONO

O : Yes
X : No



This recycle mark indicates that the packaging conforms to the environmental protection legislation in Germany.

Esta marca de reciclaje indica que el empaquetado se ajusta a la legislación de protección ambiental en Alemania.

CASIO®