

USER'S GUIDE

Initial Setup



Preparing a Power Supply



Turning Power On or Off



Using Pedals



Using Commercially Available Headphones

Playing the Digital Piano



Playing Notes with Different Tones



Sounding Two Different Tones at the Same Time (Layer)



Splitting the Keyboard Between Two Tones (Split)



Using the Metronome

Changing Sound Reverberation and Ambiance



Using the Sound Mode Effects (Hall Simulator/ Reverb and Surround)



Using Chorus (Chorus, Flanger, Short Delay)



Using Microphone Effects



Adjusting Acoustic Piano Sound Characteristics (Acoustic Simulator)

Using the Mixer



Using DSP Effects



Adjusting the Volume Level, Stereo Pan and Effects for Each Part

Recording Performances in Real-Time



Using the MIDI Recorder to Record Performances



Recording a Performance with the Audio Recorder

Registering a Setup



Saving and Recalling Performance Setups (Registration)

Changing the Pitch



Changing the Pitch in Semitone Steps (Transpose)



Fine Tuning a Pitch (Master Tuning)

Connecting with a Smart Device



Using the Dedicated App

- When the Digital Piano is being operated on battery power only, notes may sound distorted when performing or playing back a song at maximum volume. This is due to the difference between AC adaptor power and battery power, and does not indicate Digital Piano malfunction. If you notice distortion, switch to AC adaptor power or lower the volume level.

- Any reproduction of the contents of this manual, either in part or its entirety, is prohibited. Except for your own, personal use, any other use of the contents of this manual without the consent of CASIO is prohibited under copyright laws.
- IN NO EVENT SHALL CASIO BE LIABLE FOR ANY DAMAGES WHATSOEVER (INCLUDING, WITHOUT LIMITATION, DAMAGES FOR LOSS OF PROFITS, BUSINESS INTERRUPTION, LOSS OF INFORMATION) ARISING OUT OF THE USE OF OR INABILITY TO USE THIS MANUAL OR PRODUCT, EVEN IF CASIO HAS BEEN ADVISED OF THE POSSIBILITY OF SUCH DAMAGES.
- The contents of this manual are subject to change without notice.
- The actual appearance of the product may be different from that shown in the illustrations in this User's Guide.
- The Bluetooth® word mark and logos are registered trademarks owned by Bluetooth SIG, Inc. and any use of such marks by CASIO COMPUTER CO., LTD. is under license. Other trademarks and trade names are those of their respective owners.
- Company and product names used in this manual may be registered trademarks of others.

Included and Optional Accessories

Use only accessories that are specified for use with this Digital Piano.

Use of unauthorized accessories creates the risk of fire, electric shock, and personal injury.



- You can get information about accessories that are sold separately for this product from the CASIO catalog available from your retailer, and from the CASIO website.

<https://support.casio.com/global/en/emi/manual/PX-S6000/>



Contents

Overview and Setup	EN-6
General Guide	EN-6
Touch Operation and Notation Used in this Guide	EN-9
Preparing a Power Supply	EN-10
Using an AC Adaptor	EN-10
Using Batteries	EN-12
Turning Power On or Off	EN-16
Auto Resume	EN-17
Auto Power Off	EN-17
Disabling Auto Power Off	EN-17
Power On Alert	EN-18
Panel Lights Off	EN-18
Adjusting Display Contrast	EN-19
Adjusting the Volume	EN-19
Using Commercially Available Headphones	EN-19
Outputting From the Speakers While Headphones are Connected	EN-20
Headphone Mode	EN-20
Using a Commercially Available Microphone	EN-21
Operation Lock	EN-22
Options for Connecting to Smart Devices, Computers, and External Audio Devices	EN-23
Using the Included Wireless MIDI & Audio Adaptor	EN-24
Returning to Initial Factory Defaults	EN-24
Operations Common to All Modes	EN-25
Using the Touch Buttons and Touch Ring	EN-25
Touch Ring Basic Operation	EN-25
Setting the Sensitivity of the Touch Buttons and Touch Ring	EN-26
Setting the Volume of the Sound Made When the Touch Ring is Used (Operation Click Volume)	EN-26
Basic Operation for Contents of the Display	EN-27
Selecting Operation Items	EN-27
Navigating the Hierarchy of Setting Items	EN-30
The F Button Menu and FUNCTION Menu	EN-31
Using the F Button Menu	EN-31
Using the FUNCTION Menu	EN-33
Text Character Input	EN-35
Acoustic Settings for the Digital Piano and Playback of the Demo Songs	EN-38
Selecting the Piano Position Setting	EN-38
Listening to the Demo Songs	EN-39
Playing Notes with Different Tones	EN-41
Selecting a Single Tone	EN-41
Selecting a Tone by Number	EN-41
Selecting a Tone by Category	EN-42
Selecting a Tone with the Touch Buttons	EN-42
Selecting a Tone with the F Buttons	EN-43
Guitar and Bass Tones	EN-43

Sounding Two Different Tones at the Same Time (Layer)	EN-44
Layering Two Tones	EN-44
Unlayering the Keyboard	EN-45
Splitting the Keyboard Between Two Tones (Split)	EN-46
Splitting the Keyboard Between Two Different Tones	EN-46
Changing the Split Point	EN-47
Unsplitting the Keyboard	EN-47
Changing Part Settings (Volume Level, Octave Shift, Tuning, etc.)	EN-48
Applying Effects	EN-49
Using the Sound Mode Effects (Hall Simulator/Reverb and Surround)	EN-49
Enabling or Disabling the Hall Simulator/Reverb and Surround Effects	EN-49
Specifying the Hall Simulator/Reverb Type	EN-50
Adjusting the Depth of the Hall Simulator/Reverb Effect	EN-51
Specifying the Surround Type	EN-51
Using DSP Effects	EN-52
Enabling or Disabling DSP	EN-52
Selecting a DSP Type	EN-53
Configuring DSP Settings	EN-53
Using Chorus (Chorus, Flanger, Short Delay)	EN-57
Changing the Chorus Type	EN-57
Adjusting the Depth of the Chorus Effect	EN-57
Adjusting Brilliance	EN-58
Adjusting Acoustic Piano Sound Characteristics (Acoustic Simulator)	EN-59
List of Acoustic Piano Sound Setting Items	EN-60
Using Microphone Effects	EN-61
Enabling or Disabling the Microphone Effect	EN-61
Specifying the Microphone Effect Type	EN-62
Changing Microphone Effect Settings	EN-63
Using the Mixer	EN-65
Adjusting the Volume Level, Stereo Pan and Effects for Each Part	EN-65
List of Mixer Setting Items	EN-66
Changing the Sound During a Performance	EN-67
Using Pedals	EN-67
PEDAL UNIT jack	EN-67
EXPRESSION/ASSIGNABLE jack	EN-68
Enabling/Disabling the Pedal Operation for Each Part (Upper 1/Upper 2/Lower)	EN-71
Using the Knobs	EN-72
Using the Knobs to Change Parameters	EN-72
Changing the Function Assigned to a Knob	EN-73
Resetting the Parameters of the Functions Currently Assigned to the Knobs	EN-76
Using the CONTROL Button	EN-77
Selecting the Function Assigned to the CONTROL Button	EN-77
Using the Pitch Bend Wheel	EN-79
Changing the Pitch Bend Range	EN-79
Enabling/Disabling the Pitch Bend Wheel Operation for Each Part (Upper 1/Upper 2/Lower)	EN-80

Using the Metronome	EN-81
Starting or Stopping the Metronome	EN-81
Changing the Metronome Settings (Tempo, Beat, Pattern, etc.)	EN-81
Using the Arpeggiator	EN-84
Enabling or Disabling the Arpeggiator	EN-84
Changing the Arpeggiator Pattern and Other Settings	EN-84
Saving and Recalling Performance Setups (Registration)	EN-86
Saving a Setup Registration	EN-87
Changing a Registration Bank Name	EN-88
Recalling a Setup Registration	EN-89
Freeze Function	EN-90
Using a Pedal to Cycle Through Multiple Setup Registrations (Sequential Recall)	EN-91
Registration Memory Data	EN-92
Saving to an External Device	EN-93
Using the F Button Set	EN-94
Preset F Button Set List	EN-94
Editing an F Button Set	EN-95
Assigning a Function to an F Button (Creating a User F Button Set)	EN-95
Changing the Name of an F Button Set	EN-100
Erasing an F Button Set	EN-102
F Button Function List	EN-103
Listening to Songs (SONG Mode)	EN-106
Data Types of Playable Songs	EN-106
Playing Back MIDI Data or Audio Data	EN-107
Operations While Playing Back MIDI Data	EN-109
Sounding Metronome While Playing Back MIDI Data	EN-109
Adjusting the Volume Level of MIDI Data Playback (MIXER Settings)	EN-109
Deleting a User Song	EN-109
Operations While Playing Back Audio Data	EN-110
Audio Center Cancel (Vocal Cut)	EN-110
Adjusting the Volume Level or Effect Depth of Audio Data Playback (MIXER Settings)	EN-110
Recording Performances	EN-111
MIDI Recorder and Audio Recorder Features	EN-111
Using the MIDI Recorder to Record Performances	EN-113
Recording with the MIDI Recorder	EN-113
Recording a Second Track Over the First (System Track + Solo Track)	EN-117
Playing Back MIDI Recorder Songs	EN-118
Deleting a MIDI Recorder Song (Entire Song/Individual Tracks)	EN-119
Items Reflected in Contents When Recording to the MIDI Recorder Song	EN-120
Recording a Performance with the Audio Recorder	EN-122
Recording Using the Audio Recorder	EN-122
Playing Back a Song from the Audio Recorder	EN-125
Deleting a Song from the Audio Recorder	EN-126

Adjusting Keyboard Sensitivity	EN-127
Changing Keyboard Response to Key Velocity (Touch Response)	EN-127
Changing Touch Response Sensitivity	EN-127
Adjusting the Timing of Key Press to Sound (Hammer Response)	EN-128
Adjusting the Hammer Response	EN-128
Adjusting the Timing of Key Release to Sound Damping (Key-off Response)	EN-129
Adjusting the Key-off Response	EN-129
Changing the Pitch	EN-130
Changing the Pitch in Semitone Steps (Transpose)	EN-130
Changing the Transpose Setting	EN-130
Fine Tuning a Pitch (Master Tuning)	EN-130
Adjusting the Tuning Separately for Each Part (Upper 1/Upper 2/Lower) (Part Fine Tune)	EN-131
Changing the Pitch in Octave Units (Octave Shift)	EN-132
Using Octave Shift Separately for Each Part (Upper 1/Upper 2/Lower)	EN-132
Changing the Scale Tuning (Temperament) of the Keyboard	EN-133
Changing the Scale	EN-133
Enabling or Disabling Piano Stretch Tuning	EN-134
Splitting the Keyboard for Duet Play	EN-135
Using the Duet	EN-135
Configuring Duet Settings	EN-137
USB Flash Drive	EN-138
Preparing a USB Flash Drive	EN-138
Supported USB Flash Drives	EN-138
Data Types Supported by the Digital Piano	EN-139
Connecting a USB Flash Drive to and Detaching It from the Digital Piano	EN-141
Formatting a USB Flash Drive	EN-142
Saving MIDI Files or Audio Files for Playback on your Digital Piano to a USB Flash Drive	EN-143
Saving Digital Piano Data to a USB Flash Drive	EN-143
Loading USB Flash Drive Data into the Digital Piano's Internal Memory	EN-145
Deleting a USB Flash Drive File	EN-146
Renaming a USB Flash Drive File	EN-147
Configuring MIDI Settings	EN-148
Wireless Connections	EN-149
Configuring Wireless (Bluetooth) Connection Settings	EN-149
Checking the Wireless Connection Status	EN-149
Enabling and Disabling the Digital Piano's Wireless Function	EN-149
Notification Tones	EN-150
Connecting the Digital Piano with a Bluetooth Low Energy MIDI Device	EN-151
Connecting the Digital Piano with a Bluetooth Audio Device	EN-152
Pairing the Digital Piano with a Bluetooth Audio Device	EN-152
Deleting Bluetooth Audio Device Pairing Registration	EN-153

Using the Dedicated App	EN-155
About the App for Smart Devices (CASIO MUSIC SPACE)	EN-155
Connecting with External Devices	EN-157
Playing Sound from a Smart Device on This Digital Piano (Bluetooth Audio Connection)	EN-157
Playing Audio from a Smart Device or Other Bluetooth-compatible Device on this Digital Piano . . .	EN-157
Adjusting the Volume Level or Effect Depth of Bluetooth Audio (MIXER Settings)	EN-157
Bluetooth Audio Center Cancel (Vocal Cut)	EN-158
Using MIDI with a Connected Computer or Smart Device	EN-159
Connecting the Digital Piano with a Computer via USB MIDI	EN-159
Connecting the Digital Piano with a Smart Device via USB MIDI	EN-161
Outputting Digital Piano Notes Through an Amplifier or Audio Equipment (LINE OUT jacks)	EN-163
Connecting to Audio Equipment	EN-163
Connecting to a Musical Instrument Amplifier	EN-164
Deleting All Data in the Digital Piano's Internal Memory	EN-165
Troubleshooting	EN-166
Error Messages	EN-168
Reference	EN-170
Product Specifications	EN-170
Operating Precautions	EN-173
FUNCTION Menu Items	EN-176
DSP List	EN-184
Preset DSP List	EN-184
List of Effects in the DSP Modules	EN-187
Parameter List of DSP Module Effects	EN-189
Amp Cab Type List	EN-202
IR Type List	EN-204
Microphone Effects List	EN-226
Microphone Effect Type List	EN-226
List of Effects in the Microphone Effects Module	EN-227
Parameter List of Module Effects	EN-228
Arpeggiator List	EN-233
MIDI Implementation Chart	

Overview and Setup

General Guide

■ Front Panel

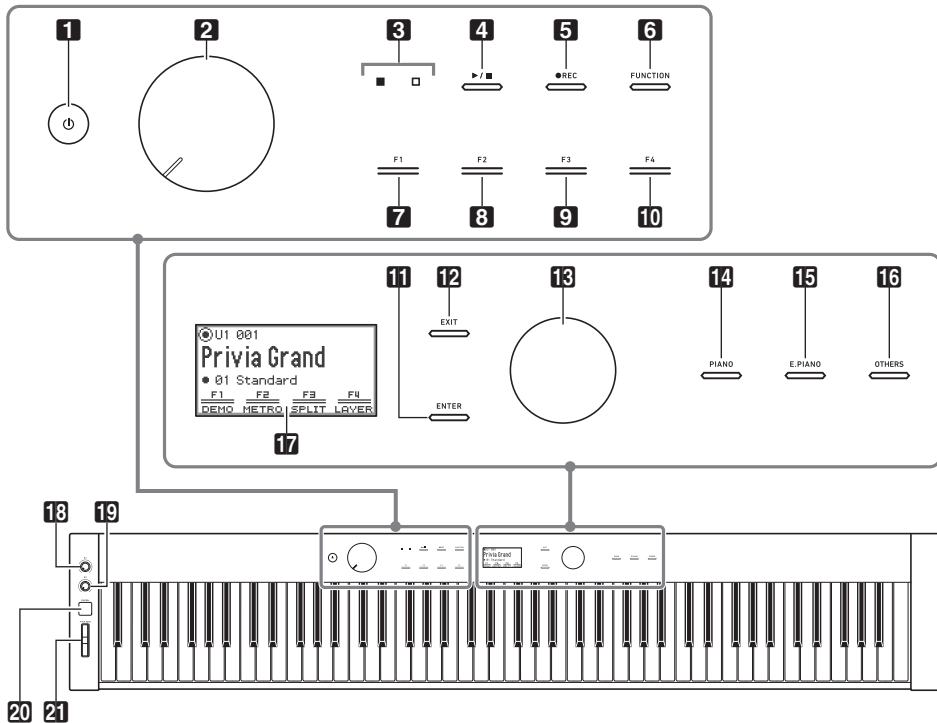

1 (Power) button

2 Volume knob

3 LED (Red, White)

4 button

5 **REC** button

6 **FUNCTION** button

7 **F1** button

8 **F2** button

9 **F3** button

10 **F4** button

11 **ENTER** button

12 **EXIT** button

13 Touch ring

14 **PIANO** button

15 **E. PIANO** button

16 **OTHERS** button

17 Display

18 **K1** knob

19 **K2** knob

20 **CONTROL** button

21 **PITCH BEND** wheel

Touch Buttons and Touch Ring

Turning on Digital Piano power causes all of the touch buttons (14 to 12, 14 to 13) and the touch ring (13) to light. The above illustration shows when all buttons are lit. During actual operation, only the buttons that are currently enabled are lit or flashing.

Keyboard note names and pitches

The keyboard note names and pitches used in this manual follow the international standard. Middle C is C4, the lowest C is C1, and the highest C is C8. The illustration below shows keyboard key note names from C4 through C5.



■ Front

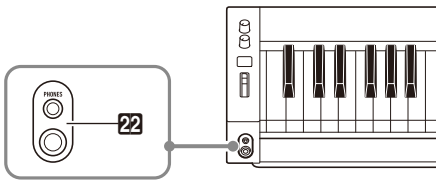

22 PHONES jacks

Top: stereo mini phone jack
(Mini TRS phone)
Bottom: stereo standard phone jack
(TRS phone)

■ Back

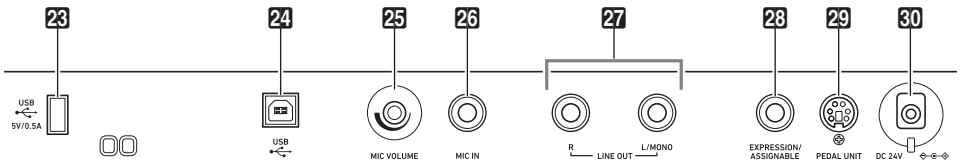

23 **USB** Type A port

24 **USB** Type B port

25 **MIC VOLUME** knob

26 **MIC IN** jack

27 **LINE OUT R, L/MONO** jacks

28 **EXPRESSION/ASSIGNABLE** jack

29 **PEDAL UNIT** jack

30 **DC 24V** terminal

■ Display (Top Screen)

The top screen is the screen that appears on the display when the Digital Piano is turned on.

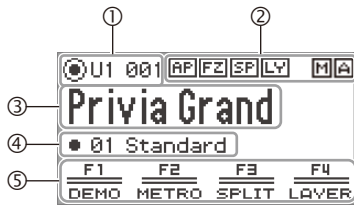

- ① Part name, Tone number
- ② Indicators
- ③ Tone name
- ④ F Button Set name
- ⑤ F Button Menu

Inverted screens

The display of this Digital Piano shows screens white on a black background; however, this guide depicts them as black on a white background.

■ Preparing the Music Stand

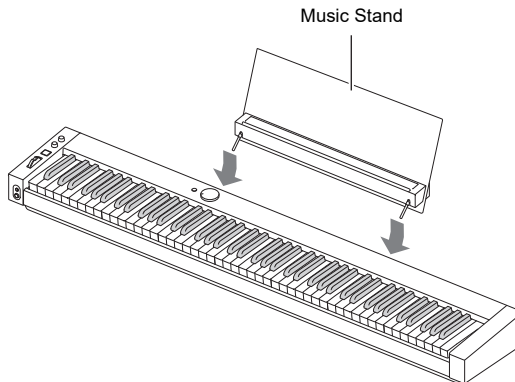

Touch Operation and Notation Used in this Guide

■ Touch Ring Operation and Notation

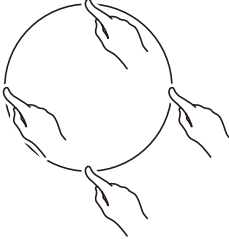
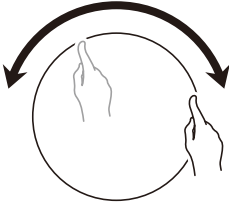
This operation	is shown like this
Touch and immediately release the top, bottom, left or right edge of the touch ring 	Touch top, bottom, left or right on the touch ring. It is also written as follows: <ul style="list-style-type: none"> • Use the touch ring to change the value. • Use the touch ring to select “___”.
Trace the circumference of the touch ring with your finger in a counterclockwise or clockwise direction  (Acts as a controller to change settings.)	Trace on the touch ring. It is also written as follows: <ul style="list-style-type: none"> • Use the touch ring to change the value. • Use the touch ring to select “___”.

■ Touch Button Operation and Notation

This operation	is shown like this
Touch and immediately release the EXIT button	Touch the EXIT button.
Hold the EXIT button down for about 2 seconds and then release it	Touch and hold the EXIT button.

■ F Buttons (F1 to F4) Operation and Notation

This operation	is shown like this
Touch and immediately release the F1 button F Button Menu on the display: 	Touch the F1 button (DEMO). It is also written as follows: <ul style="list-style-type: none"> • Touch the F button to which “DEMO” is assigned.

Preparing a Power Supply

The Digital Piano can be powered by an AC adaptor or AA batteries (alkaline or rechargeable nickel-metal-hydride).

Using an AC Adaptor

Use only the AC adaptor (JEITA Standard, with unified polarity plug) that comes with this Digital Piano. Use of a different type of AC adaptor can cause malfunction of the Digital Piano.

<Specified AC Adaptor: AD-E24250LW>

Use the supplied power cord to connect the AC adaptor.

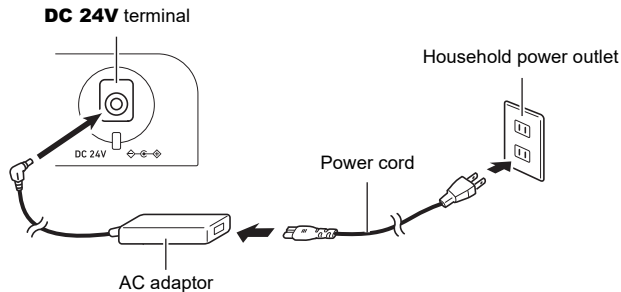

The AC adaptor cannot be repaired.

AC Adaptor Usage Environment Temperature: 0 to 40°C

Humidity: 10% to 90%RH

Output Polarity: 

IMPORTANT!

- **Never connect the AC adaptor that comes with this Digital Piano to any other device besides this Digital Piano. Doing so creates the risk of malfunction.**
- **Make sure the Digital Piano is turned off before plugging in or unplugging the AC adaptor.**
- **The AC adaptor will become warm to the touch after very long use. This is normal and does not indicate malfunction.**
- **Unplug the AC adaptor from the power outlet if you do not plan to use the Digital Piano for a long time.**

■ Disconnect Protection Precautions

- (1) Never pull on the cord with excessive force.
- (2) Never repeatedly pull on the cord.
- (3) Never twist the cord at the base of the plug or connector.

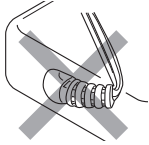

- (4) Loop and bundle the power cord, but never wind it around the AC adaptor.

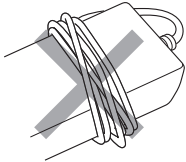

- (5) Before moving the Digital Piano, be sure to unplug the AC adaptor from the power outlet.

■ Locating the AC Adaptor for Use

- When using the AC adaptor, put in a location that satisfies the conditions below.
 - A location free of splashing liquids.
The AC adaptor is designed for indoor use only. Do not put it in a location where it may become wet and do not place a vase or any other container of liquid on top of it.
 - A location that is not humid.
 - A roomy, well ventilated location.
Do not cover the AC adaptor with newspaper, table cloth, curtain, or any other type of fabric.
 - Use a power outlet that is located near the Digital Piano.
This will let you immediately unplug from the power outlet should any problem occur.
- When using the AC adaptor, place it on the floor with its label surface downwards. The AC adaptor becomes prone to emitting electromagnetic waves when the label surface is facing upwards.

Using Batteries

IMPORTANT!

- Be sure to turn off power before loading batteries.
- Use commercially available AA-size alkaline batteries or AA-size eneloop rechargeable batteries.
- Low battery power can cause abnormal operation. If this happens, replace batteries with new ones. If you are using rechargeable batteries, charge them.
- Note the precautions below while the Digital Piano is turned upside down to load batteries.
 - Take care to avoid injury due to pinching your fingers under the Digital Piano.
 - Do not allow the Digital Piano to tip over or otherwise be subjected to strong impact. Impact can damage the volume knob and keyboard keys.
- Be sure to replace batteries at least once a year, even if there is no indication of low battery power. Dead rechargeable batteries in particular may deteriorate if they are left in the product. Remove rechargeable batteries from the product as soon as possible after they go dead.

■ Rechargeable Batteries

Note the precautions below when using rechargeable batteries.

- Use Panasonic Group AA-size eneloop rechargeable batteries. Do not use any other type of batteries.
- Use only the specified charger to charge batteries.
- Rechargeable batteries must be removed from the product for charging.
- Dead rechargeable batteries may deteriorate if they are left in the product. Remove rechargeable batteries from the product as soon as possible after they go dead.
- For information about using rechargeable batteries or their specified charger, be sure to read the user documentation and precautions that come with each item, and use them only as directed.

■ To load batteries

- 1. Open the battery cover on the bottom of the Digital Piano.**

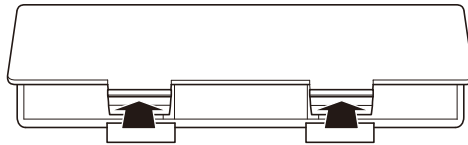

- 2. Load eight AA-size batteries into the battery compartment.**

- Load batteries with their positive ⊕ and negative ⊖ ends facing correctly.

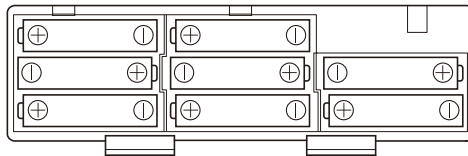

- 3. Insert the tabs of the battery cover into the holes along the side of the battery compartment, and close the cover.**

- Configure the setting below to specify the type of batteries you loaded.

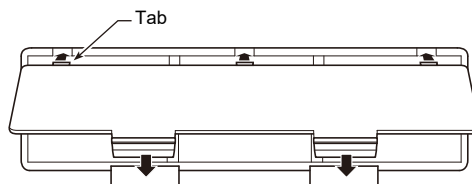

■ To select the Battery Type

Select the battery type that matches the battery installed in this Digital Piano's battery case.

- 1. Touch the **FUNCTION** button.**
The **FUNCTION** menu appears.
- 2. Touch the top or bottom of the touch ring to select “SYSTEM” and then touch the **ENTER** button.**
- 3. Touch the top or bottom of the touch ring to select “Battery Type” and then touch the **ENTER** button.**
The “Battery Type” screen appears.
- 4. Touch the top or bottom of the touch ring to select the battery type.**



Alkaline: Alkaline batteries

Ni-MH: Rechargeable nickel metal hydride batteries

■ Low Battery and Replace Battery Notifications

A battery icon appears on the display to let you know when battery power is getting low.

Low Battery Indicator

Low battery icon (not flashing)



Replace Battery Indicator

Replace battery icon (flashing)



⚠ IMPORTANT!

- To avoid possible injury, close the cover of the battery compartment before using the Digital Piano.
- Note that the battery compartment on the bottom of the Digital Piano may become hot in use.
- Using the Digital Piano while batteries are very low can cause it to turn off suddenly. This can cause data stored in the Digital Piano's internal memory to be corrupted or lost.

Turning Power On or Off

1. Before turning on the power, turn the volume knob to the position shown below.

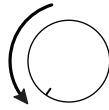

2. Press the **⏻** (Power) button to turn on the Digital Piano.

When the power is turned on, “Welcome” appears on the display.

- When the display changes to the top screen, the Digital Piano is ready to use.
- The time it takes for the Digital Piano to become ready to use depends on the internal memory usage.



Top screen

- Do not touch the pitch bend wheel when turning on the power.
- After pressing the **⏻** (Power) button, do not step on any pedals until the top screen appears.
- The Digital Piano may not turn on if the **⏻** (Power) button is pressed lightly, but this is not a malfunction. If this happens, firmly press the **⏻** (Power) button again.

3. Use the volume knob to adjust the volume.

4. To turn off the Digital Piano, press and hold the **⏻** (Power) button for a moment.

- The light of the touch ring goes around once and goes out, and the message “Bye” appears on the display.

NOTE

- In its initial state, when the Digital Piano is turned on without the Wireless MIDI & Audio Adaptor installed, the **[M]** **[A]** indicator flashes briefly in the upper-right corner of the top screen to indicate that the Wireless MIDI & Audio Adaptor is not installed.
- Even after the power is turned off using the **⏻** (Power) button, the Digital Piano remains in standby mode with a small current flowing through it. Always disconnect the AC adaptor from the power outlet when the Digital Piano will not be used for an extended period or when there is a risk of lightning.
- When Auto Resume (page [EN-17](#)) is set to “Off”, turning off the power will reset various settings, but the Digital Piano still retains the following settings.

Tuning, LCD Contrast, pairing information (Bluetooth connection history), expression pedal type, expression pedal calibration, Touch Button Sensitivity, Touch Ring Sensitivity, Operation Click Volume, Auto Power Off, Wireless Notification Volume, Battery Type

Auto Resume

When the Digital Piano is turned off, various settings such as tone numbers are reset. If “SYSTEM” > “Auto Resume” is set to “On” in the FUNCTION menu (page EN-33), most settings will be retained even when the power is turned off.

Auto Power Off

This Digital Piano is designed to turn off automatically to avoid wasting power after no operation is performed for a preset amount of time. The Auto Power Off trigger time is about four hours when power is being supplied by the AC adaptor, or six minutes under battery power.

Disabling Auto Power Off

You can disable Auto Power Off to ensure that power does not turn off automatically during a concert, etc.

NOTE

- The Auto Power Off function does not work when there is any input from a smart device that is wirelessly connected to the Digital Piano.

- 1. Touch the **FUNCTION** button.**
The FUNCTION menu appears.
- 2. Touch the top or bottom of the touch ring to select “SYSTEM” and then touch the **ENTER** button.**
- 3. Touch the top or bottom of the touch ring to select “Auto Power Off” and then touch the **ENTER** button.**
The “Auto Power Off” screen appears.
- 4. Touch the top or bottom of the touch ring and select “Off”.**



Power On Alert

When the AC adaptor is used, the touch button will flash after six minutes of inactivity to notify the user that the power has not been turned off. The power-off notification function works when “SYSTEM” > “Power On Alert” in the FUNCTION menu (page EN-33) is set to “On” (default). If set to “Off”, no alert will be given.

Note that the “Power On Alert” does not function if battery power is being used. After about one minute of inactivity, all LEDs except the **FUNCTION** button will turn off. See “Panel Lights Off” (page EN-18).

Panel Lights Off

While the top screen (the screen that appears immediately after the power is turned on) is displayed, touching and holding the **EXIT** button until the light of the touch ring goes around once and then goes out will turn off most of the lights on the front panel, except the **FUNCTION** button and touch ring (the state the panel lights off). The front panel gives off a small amount of light, conserving power and making it easier to concentrate on playing the keyboard.

The Digital Piano maintains the state the panel lights off even when you play the keyboard or operate the pedals, pitch bend wheel, **K1** and **K2** knobs, or **CONTROL** button. Touch the **FUNCTION** button or press the  (Power) button briefly to deactivate it.

NOTE

- When the battery is used as the power source for the Digital Piano, it will automatically enter the “panel lights off” state to conserve power if the front panel (touch buttons, touch ring, etc.) is not used for about one minute.
- Even when using the AC adaptor, the lights can be set to turn off automatically after a set period to conserve power when no buttons are pressed for a certain amount of time (the light does not turn off automatically under initial default settings). Use “SYSTEM” > “Panel Light” in the FUNCTION menu (page EN-33) to specify the time (5, 30, 60, or 120 seconds) before the lights turn off.
- The panel light does not turn off during song playback or recording, or while there is an input from a smart device.

Adjusting Display Contrast

To adjust the contrast of the display, use “SYSTEM” > “LCD Contrast” in the FUNCTION menu (page EN-33).

Adjusting the Volume

Control the master volume of the Digital Piano using the volume knob.

NOTE

- The mixer function (page EN-65) allows you to individually adjust the volume of the keyboard, song playback volume, and input volume from the **MIC IN** jack.

Using Commercially Available Headphones

Using headphones cuts off output from the built-in speakers, which means you can practice playing even late at night without disturbing others.

- Be sure to turn down the volume level before connecting headphones to the **PHONES** jack.

PHONES jacks

(Top: stereo mini phone jack (Mini TRS phone)/
Bottom: stereo standard phone jack (TRS phone))

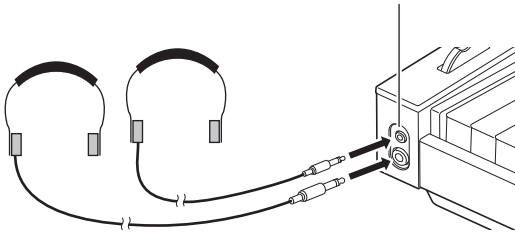

IMPORTANT!

- Do not listen to very high volume output over headphones for long periods. Doing so creates the risk of hearing damage.
- When connecting headphones to the stereo mini phone jack, be sure to use a stereo mini phone plug (Mini TRS phone). Use of other types of plugs is not supported.
- If you are using headphones that require an adaptor plug, make sure you do not leave the adaptor plugged in when you unplug the headphones. If you do, nothing will sound from the speakers when you play.
- Use commercially available headphones that meet the following conditions.
 - Maximum input: 150mW or greater
 - Impedance: 32Ω or greater
- Use of the optional CP-16 headphones is not recommended.

Outputting From the Speakers While Headphones are Connected

If “SYSTEM” > “Speaker Out” in the FUNCTION menu (page [EN-33](#)) is set to “On”, sound will come out of the speakers even if headphones are plugged into either **PHONES** jack.

- The setting values and details for this are as follows:

Setting value	Description
Off	The speakers do not output sound regardless of whether a plug is inserted into the PHONES jack.
On	The speakers output sound regardless of whether a plug is inserted into the PHONES jack.
Auto	When a plug is inserted into the PHONES jack, the Digital Piano’s speakers do not output sound; when a plug is not inserted, the speakers output sound.

Headphone Mode

When “SYSTEM” > “Headphone Mode” in the FUNCTION menu (page [EN-33](#)) is set to “On” (the initial default setting) and headphones are used, the sound quality is automatically corrected to reproduce how an acoustic piano would sound when it naturally reaches the ears of a listener.

NOTE

- The Headphone Mode setting is enabled when a plug is inserted into either **PHONES** jack.
- Regardless of the Headphone Mode setting, the sound output from the **PHONES** jacks and the **LINE OUT** jacks are the same.

Using a Commercially Available Microphone

You can connect a commercially available dynamic microphone to the **MIC IN** jack and sound audio from the microphone with the Digital Piano.

You can adjust the volume level of microphone input with the **MIC VOLUME** knob. Microphone volume control is independent from overall Digital Piano volume.

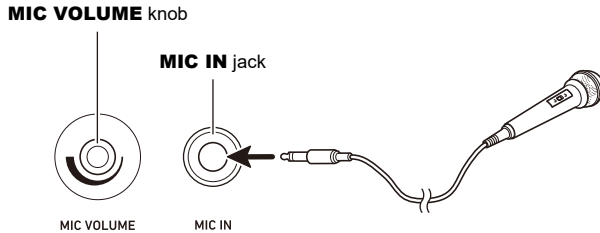

IMPORTANT!

- Before connecting a microphone, make sure that the Digital Piano and microphone are turned off.
- Before connecting, set both overall Digital Piano volume and mic volume to their lowest levels. Adjust volume settings to appropriate levels after connecting the microphone.

NOTE

- When connecting a microphone to the **MIC IN** jack, be sure to use a standard phone plug (TS phone). Use of other types of plugs is not supported.
- Various effects can be applied to the microphone input. For more information, see [“Using Microphone Effects”](#) (page EN-61).
- The mixer function allows you to independently adjust the volume of the microphone input audio and the send value to the Hall Simulator/Reverb. For more information, see [“Using the Mixer”](#) (page EN-65).

Operation Lock

When Operation Lock is enabled (“On” or “Auto”), all button operations except the  (Power) button and the Operation Lock release operation are disabled to prevent accidental operation during a performance.

1. Touch the **FUNCTION** button.
The FUNCTION menu appears.
2. Touch the top or bottom of the touch ring to select “SYSTEM” and then touch the **ENTER** button.
3. Touch the top or bottom of the touch ring to select “Operation Lock” and then touch the **ENTER** button.
The “Operation Lock” screen appears.



4. Touch the top or bottom of the touch ring to change the setting value.

Setting value	Description
Off	Disables the Operation Lock.
On	The lights of all buttons except the FUNCTION button turn off, and all button operations except the  (Power) button and the FUNCTION button are disabled.
Auto	All button operations are disabled while playing. When you stop playing, it will return to the normal state (the same state as when “Operation Lock” is “Off”) after about one second.

5. Touch and hold the **EXIT** button to exit settings.
When “On” is selected, all buttons except the **FUNCTION** button are disabled.

Options for Connecting to Smart Devices, Computers, and External Audio Devices

The connection method for an external device depends on what you want to do. Refer to the section indicated for “Connection method” that matches “What you want to do” in the table below.

NOTE

- “Smart devices” in the table below means smartphones (iPhone, Android) or tablets (iPad, Android).
- For details about “CASIO’s dedicated app” mentioned in the table below, see “[About the App for Smart Devices \(CASIO MUSIC SPACE\)](#)” (page EN-155).

What you want to do	Connect via <u>Wireless Connection</u> * ¹		Connect via <u>Cable</u>	
	Bluetooth audio	Bluetooth Low Energy MIDI	USB cable	Audio cable
I want to use CASIO’s dedicated app on my <u>smart device</u>	“Using the Dedicated App” (page EN-155)			—
I want to play the sound output by a <u>smart device</u> from this Digital Piano using Bluetooth audio	“Playing Sound from a Smart Device on This Digital Piano (Bluetooth Audio Connection)” (page EN-157)	—	—	—
I want to connect my <u>PC or smart device</u> to the Digital Piano and use MIDI	—	* ²	“Using MIDI with a Connected Computer or Smart Device” (page EN-159)	—
I want to output the sound from this Digital Piano through <u>external speakers or audio equipment</u>	—	—	—	“Outputting Digital Piano Notes Through an Amplifier or Audio Equipment (LINE OUT jacks)” (page EN-163)

*¹ Using the included Wireless MIDI & Audio Adaptor.

*² Use with apps other than CASIO’s dedicated app is not guaranteed to work.

Using the Included Wireless MIDI & Audio Adaptor

To pair this Digital Piano with a Bluetooth® wireless technology-capable external device, you need to plug the Wireless MIDI & Audio Adaptor into the Digital Piano's **USB** Type A port.

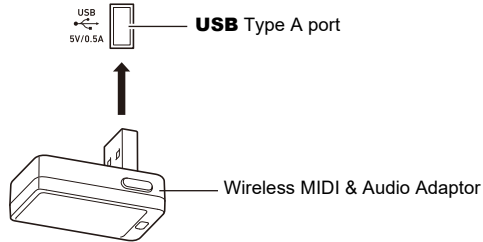

! IMPORTANT!

- Turn off the Digital Piano before disconnecting the Wireless MIDI & Audio Adaptor.

Returning to Initial Factory Defaults

You can use Factory Reset to return the Digital Piano's stored data and settings to their initial factory defaults any time you want. For more information, see "[To return all Digital Piano settings and data to their initial factory defaults \(Factory Reset\)](#)" (page [EN-165](#)).

Operations Common to All Modes

IMPORTANT!

- Unless otherwise specifically noted, all of the procedures in this manual assume that the Digital Piano is in its initial power on state (immediately after you turn on power). If you run into problems with a procedure, turn Digital Piano power off and back on, and then try performing the procedure again.
- Note that turning off Digital Piano power during a procedure causes any pending unsaved data to be deleted.

Using the Touch Buttons and Touch Ring

Turning on Digital Piano power causes the touch buttons and touch ring to light.

Touch Ring Basic Operation

The touch ring is used to move the cursor between items on a list and to change values.

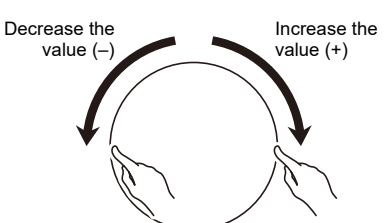
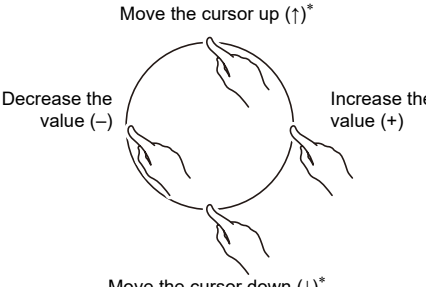
<ul style="list-style-type: none">• Trace along the touch ring to continuously change the value of the currently selected item on the screen.	<ul style="list-style-type: none">• Touch the left or right of the touch ring to change the value one unit at a time. Touch the top or bottom of the touch ring to move the cursor between items*.
	
<p>Tracing clockwise (+) along the touch ring until the value becomes its maximum value, it will stop at that value. Likewise, tracing counterclockwise (-) along the touch ring until the value becomes its minimum value, it will stop at that value.</p>	<p>Touching the left of the touch ring (-) after the minimum value is reached sets the maximum value. Likewise, touching the right of the touch ring (+) after the maximum value is reached sets the minimum value.</p>

* While the close-up screen (page EN-29) or the value list screen (page EN-30) is being displayed, touching the top or bottom of the touch ring changes values.

NOTE

- For an example of a specific operation using the touch ring, see “Basic Operation for Contents of the Display” (page EN-27).
- To reset the value of the item currently selected on the screen to its initial default value, touch and hold the **FUNCTION** button and touch the top, bottom, left, or right of the touch ring.

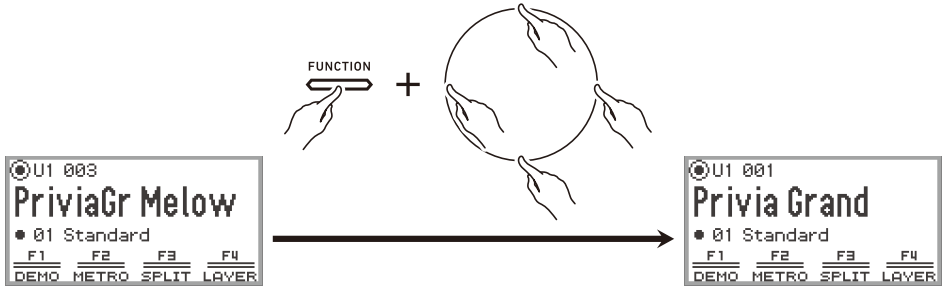



Setting the Sensitivity of the Touch Buttons and Touch Ring

The sensitivity of the touch buttons can be adjusted using “SYSTEM” > “Touch Btn Sense” in the FUNCTION menu (page EN-33). You can also adjust the sensitivity of the touch ring using “SYSTEM” > “Touch Ring Sense”.

■ If Operation Becomes Difficult Due to Low Sensitivity Settings

If operation becomes difficult or impossible after using the FUNCTION menu to lower the touch button and touch ring sensitivity, you can set the touch button and touch ring sensitivity to a higher level than normal using the procedure below.

1. Turn off the Digital Piano.
2. While pressing the C8 key (rightmost key), press the  (Power) button.
 - You can release the  (Power) button immediately, but do not release the C8 key until “Welcome” appears on the display.

Setting the Volume of the Sound Made When the Touch Ring is Used (Operation Click Volume)

The “SYSTEM” > “Op. Click Volume” in the FUNCTION menu (page EN-33) can be used to adjust the volume of the click sound made when the touch ring is used.

Basic Operation for Contents of the Display

Selecting Operation Items

The dots (●) shown on the display of the Digital Piano indicate items that can be used with the touch ring or **ENTER** button.

- When the cursor is on a dot (●), you can change the value of that item by tracing along the touch ring.
- When the cursor is on a dot (●), touch the **ENTER** button to display the list screen (category list screen or value list screen) corresponding to that item*.
- Move the cursor (○) by touching the top or bottom of the touch ring.

* Operations after touching the **ENTER** button are described in a later section.



Select the item to adjust and use the touch ring to change its value. Try out the following operations.

1. Turn on the Digital Piano.

The top screen appears.



2. Touch the top or bottom of the touch ring.

Each touch of the touch ring moves the cursor (○) between the dots.



3. Move the cursor (○) to the item whose value you want to change.

For example, move the cursor (○) to “Part name and tone number”.

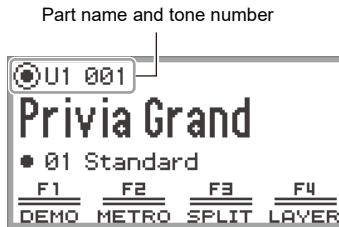

4. Touch the left or right or trace along the touch ring.

The value at the cursor position (tone number in this example) changes.



- Instead of touching the left or right or tracing along the touch ring, you can use the value list that appears when you touch the **ENTER** button. Refer to the following to use this method.
 - “Navigating the Hierarchy of Setting Items” (page EN-30)
 - “Using the F Button Menu” (page EN-31)
 - “Using the FUNCTION Menu” (page EN-33)

■ Close-Up Screen

If the setting of "SYSTEM" > "Close-up" in the FUNCTION menu (page [EN-33](#)) is changed from "Off" (default value) to "On", the display will show a "close-up screen" that magnifies the value whenever you trace along the touch ring to change a value. For example, in Step 4 above, the following screen will appear.



- While the close-up screen is displayed, you can also change values by touching the top, bottom, left, or right of the touch ring.
- The display returns to the original screen after about 5 seconds once you remove your finger from the touch ring.
- To immediately return to the previous screen, touch the **EXIT** button.

Navigating the Hierarchy of Setting Items

Use the settings list screen to select from many options for tones, functions, or specific settings. The following is a schematic for navigating the hierarchy of setting items and for the sequence of operations when selecting categories, setting values, etc.

- A** Touch left or right or trace along the touch ring to directly select the setting value of the item highlighted by the cursor (○).
- B** Touching the **ENTER** button brings up a list of options for the item highlighted by the cursor (○), allowing you to select a setting value using the touch ring while viewing the list.

Try out using the **ENTER** button, **EXIT** button, and touch ring while referring to the following.

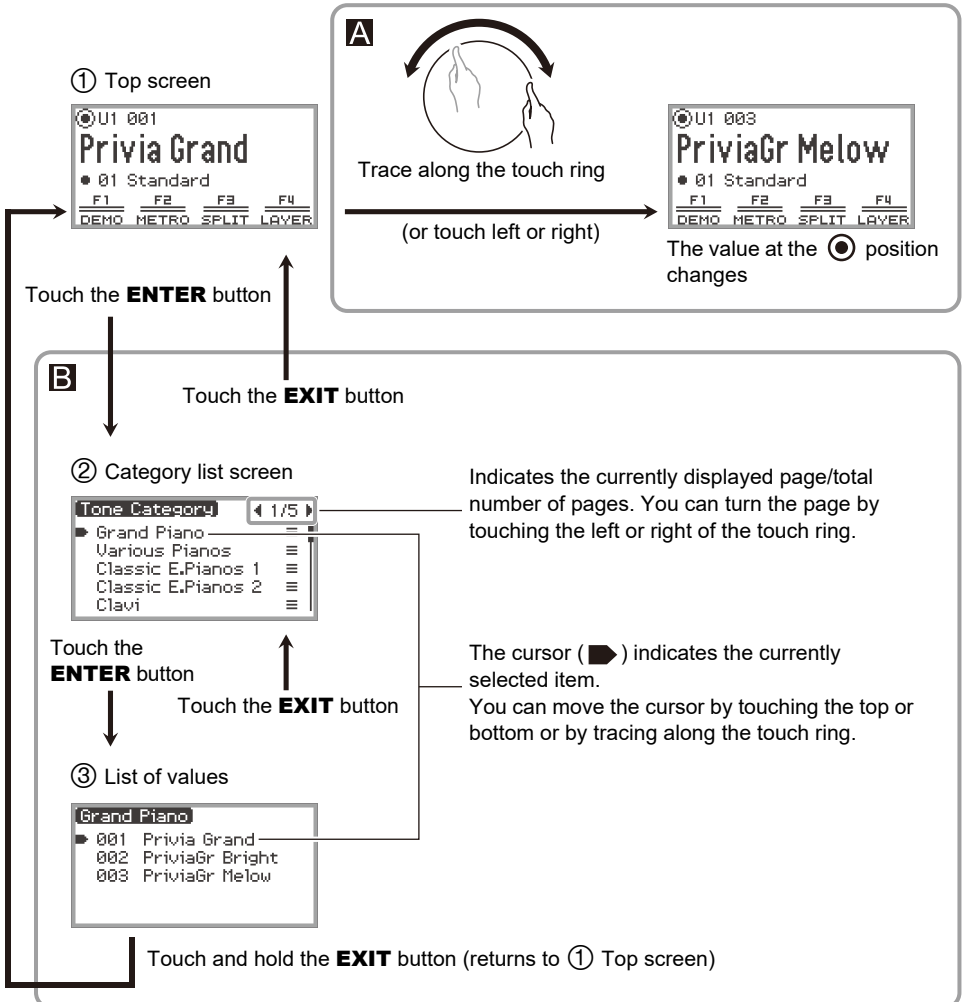

NOTE

- Touch and hold the **EXIT** button to return to the top screen.
- The description of each operating procedure in this manual omits the step of returning to the first screen using the **EXIT** button at the end of each procedure.

The F Button Menu and FUNCTION Menu

Using the F Button Menu

The F button menu shown at the bottom of the display represents the functions that will be activated when you touch the F buttons (**F1** to **F4**).

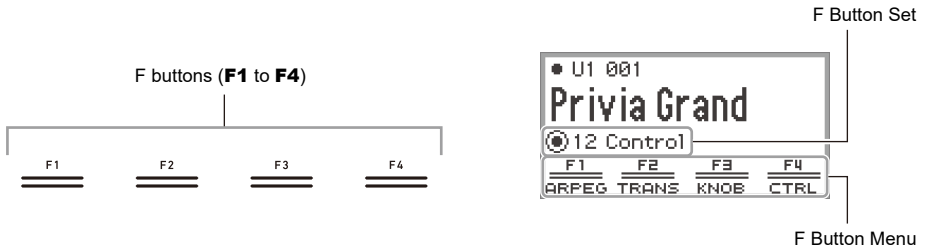

The functions displayed in the F button menu are switched by changing the F Button Set (01 to 30).

■ To change the F Button Set

1. Touch the top or bottom of the touch ring on the top screen to move the cursor (○) to the F Button Set row.

2. Touch the left or right or trace along the touch ring.

The F Button Set changes and the content of the F button menu changes, as well.



NOTE

- You can also change the F Button Set using the F Button Set list screen that appears when you touch the **ENTER** button in Step 2.



- The 30 F Button Sets include 14 presets (fixed F button functions and set names) and 16 open slots where users can freely assign functions and set names (user F Button Sets). For more information, see “Using the F Button Set” (page EN-94).

■ Significance of [] in the F Button Menu

If an F button is assigned a function that is toggled on and off each time the button is touched, the F button name appears in brackets [] when the function is on. When off, the brackets [] will disappear.

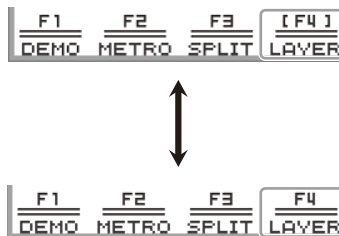

Using the FUNCTION Menu

Touch the **FUNCTION** button to display the FUNCTION menu. This menu can be used to access most of the functions and settings of the Digital Piano.

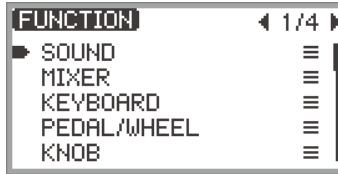

■ FUNCTION Menu Operation Example

As an example, this section describes how to change the “Hammer Response” setting.

1. Touch the **FUNCTION** button.

The FUNCTION menu appears.

2. Use the touch ring to select “KEYBOARD” > “KBD SETTING” > “Hammer Response”, in that order.

• In this manual, menu operations are written as shown above. Specific operations are as follows.

- (1) Trace the touch ring to move the cursor (▀) to “KEYBOARD”, and then touch the **ENTER** button.

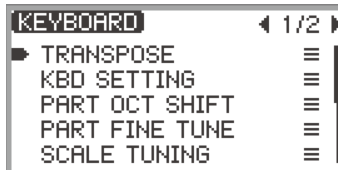
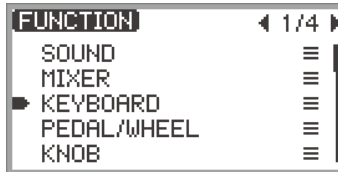

- (2) Trace the touch ring to move the cursor (▶) to “KBD SETTING”, and then touch the **ENTER** button.

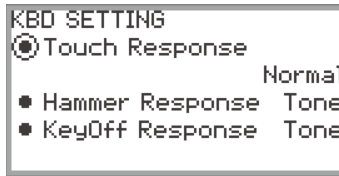

- (3) Move the cursor (○) to “Hammer Response” by touching the top or bottom of the touch ring. (This time, it is not necessary to touch the **ENTER** button.)

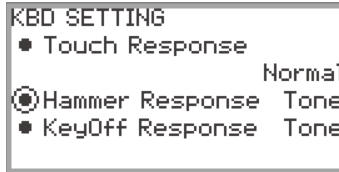

3. Change the value.

- Touch the left or right or trace along the touch ring.

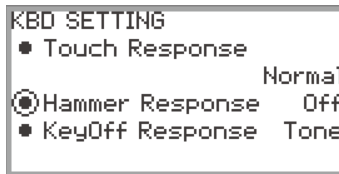

- You can also touch the **ENTER** button to display the value list screen and change the value there.

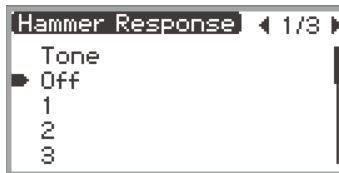

- While touching and holding the **FUNCTION** button, touching the top, bottom, left, or right of the touch ring will return it to the initial default value.

NOTE

- In the **FUNCTION** menu, each touch of the **EXIT** button moves one level up from the currently displayed level. Touch and hold the **EXIT** button to return to the top screen from any level.
- For details on all **FUNCTION** menu items, see “[FUNCTION Menu Items](#)” (page [EN-176](#)).

Text Character Input

Use the procedure below when you need to change the name of Registration Bank (page EN-88), F Button Set (page EN-100), data saved on a USB flash drive or to input or edit other text (page EN-143).

NOTE

- USB flash drive (page EN-138) file names can be up to 231 characters long.
- Up to 8 characters can appear on the display at a time.

■ To change a character

1. Touch the left or right of the touch ring on the text editing screen to move the cursor to the character you want to change.

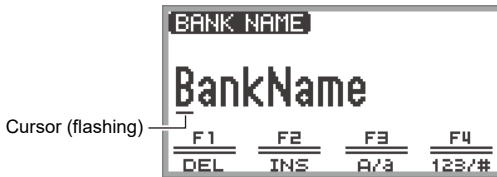

2. Trace the touch ring to change the character.

- Touching the **F3** button (A/a) switches between uppercase and lowercase letters when the cursor is located at a letter of the alphabet. When the cursor is located at a number or symbol, it switches to "A".
- Touching the **F4** button (123/#) switches between numbers and symbols when the cursor is located at a number or symbol. If the cursor is located at a letter of the alphabet, it switches to "0".
- The characters that can be used in the names of F Button Sets and Registration Banks are listed in the table below.

	0	1	2	3	4	5	6	7	8	9
A	B	C	D	E	F	G	H	I	J	K
L	M	N	O	P	Q	R	S	T	U	V
W	X	Y	Z	a	b	c	d	e	f	g
h	i	j	k	l	m	n	o	p	q	r
s	t	u	v	w	x	y	z	!	"	#
\$	%	&	'	()	*	+	,	-	.
/	:	;	<	>	=	?	@	[]	\
^	_	`	{	}						

(First cell in the above table is blank.)

- The characters shown in the table below are supported for file names on an exFAT formatted USB flash drive.

	0	1	2	3	4	5	6	7	8	9
A	B	C	D	E	F	G	H	I	J	K
L	M	N	O	P	Q	R	S	T	U	V
W	X	Y	Z	a	b	c	d	e	f	g
h	i	j	k	l	m	n	o	p	q	r
s	t	u	v	w	x	y	z	!	#	\$
%	&	'	()	+	,	-	.	;	=
@	[]	^	_	`	{	}	~		

(First cell in the above table is blank.)

- The characters shown in the table below are supported for file names on a FAT 32 formatted USB flash drive.

0	1	2	3	4	5	6	7	8	9
A	B	C	D	E	F	G	H	I	J
K	L	M	N	O	P	Q	R	S	T
U	V	W	X	Y	Z	\$	&	'	(
)	-	@	^	_	`	{	}	~	

3. Repeat steps 1 and 2 as many times as necessary.

■ To insert a character

1. Touch the left or right of the touch ring on the text editing screen to move the cursor to the position where you want to insert characters.

- To insert a character at the end of a string (append), move the cursor to the rightmost character and then touch the right of the touch ring again.

2. Touch the **F2** button (INS).

An "A" is inserted at the cursor position.

- In this state, the inserted "A" can be changed to another character. Perform Step 2 onward of "To change a character" above.

■ To delete a character

1. Touch the left or right of the touch ring on the text editing screen to move the cursor to the character you want to delete.

2. Touch the **F1** button (DEL).

■ To save edited text**1. Touch the **ENTER** button on the text editing screen.**

A confirmation screen appears. To return to the text editing screen and continue editing, touch the left (NO) of the touch ring.

**2. To save your edits, touch the right (YES) of the touch ring.**

"Complete" appears, and the display returns to the screen that preceded the text editing screen.

■ To discard edited text**1. Touch the **EXIT** button on the text editing screen.**

A confirmation screen appears. To return to the text editing screen and continue editing, touch the left (NO) of the touch ring.

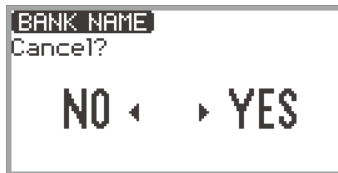
**2. To discard the edits, touch the right (YES) of the touch ring.**

Returns to the screen used before editing started.

Acoustic Settings for the Digital Piano and Playback of the Demo Songs

Selecting the Piano Position Setting

You can select the acoustic settings appropriate for the Digital Piano's location.

1. Select "04 Listening" of the F Button Set. See "To change the F Button Set" (page EN-32).



2. Touch the **F3** button (PPOSI).

The "PIANO POSITION" screen appears.

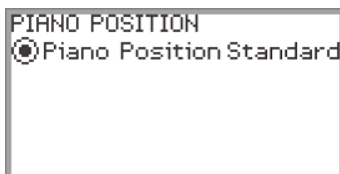

3. Trace the touch ring to select the setting that fits the location of the Digital Piano.

Setting value	Description
Standard	Standard setting when the Digital Piano is on a stand and is against (or near) a wall.
Wall	Assumed when the back of this Digital Piano is against a wall.
Center	Assumed when this Digital Piano is in the center of a room.
Table	Standard setting when the Digital Piano is placed on top of a table.

Select a setting you like in accordance with the Digital Piano's actual positioning.

Listening to the Demo Songs

Follow the steps below to play back the built-in demo songs in sequence.

1. Select the “01 Standard” of the F button set. See “To change the F Button Set” (page EN-32).



2. Touch the **F1** button (DEMO).

The ►/■ button flashes and the demo song is waiting to start.

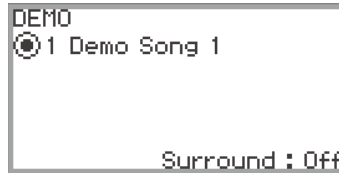

3. To select a song, trace the touch ring.

- You can also select a song as follows.
- (1) Touch the **ENTER** button to display the song list screen.

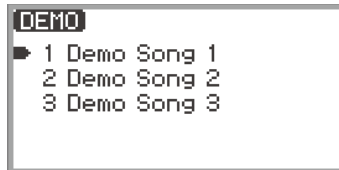

- (2) Trace the touch ring or touch the top or bottom of the touch ring to move the cursor to the song you want to select.
 - (3) Touch the **EXIT** button to return to the screen displayed in step 2.
- The steps to select a song can also be performed during demo song playback.

4. To start the demo song, touch the ►/■ button.

- Each time the ►/■ button is touched after this, the demo song is stopped or resumed.

5. To return to the top screen, touch the EXIT button. **NOTE**

- If Auto Power Off (page EN-17) is enabled, power will turn off automatically at the applicable trigger time after a period of non-use, even if a demo song is being played back.
- You can play along with the demo song on the keyboard. The keyboard tone will be the melody tone of the song being played (the tone cannot be changed).
- During the demo song, the following functions are assigned to the **CONTROL** button, and **K1** and **K2** knobs, respectively (the functions cannot be changed).

CONTROL button: Modulation

K1 knob: Cutoff Freq.

K2 knob: Resonance

Playing Notes with Different Tones

Selecting a Single Tone

This Digital Piano has many tones available. Choose your favorite tone and play it.

NOTE

- For details about tone categories and the names of tones included in each category, refer to the separate “Built-in Music Data Lists”.

Selecting a Tone by Number

1. Touch the top or bottom of the touch ring on the top screen to move the cursor (○) to the part name and tone number.

Part name: U1 (Upper 1)

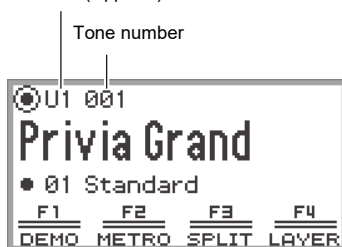

- When “U1” is displayed as the part name, the tone of the “Upper 1” part sounds when you play a keyboard key. For more information about parts, see “[Sounding Two Different Tones at the Same Time \(Layer\)](#)” (page EN-44) and “[Splitting the Keyboard Between Two Tones \(Split\)](#)” (page EN-46).

2. Trace the touch ring.

Tones are switched in numerical order.



3. When the desired tone name appears, take your finger off the touch ring.

Selecting a Tone by Category

1. Touch the top or bottom of the touch ring on the top screen to move the cursor (○) to the part name and tone number.
2. Touch the **ENTER** button.
A list of tone category names is displayed.



3. Use the touch ring to select a tone category then touch the **ENTER** button.
A list of tone names is displayed.



4. Use the touch ring to select a tone.
5. After selecting the desired tone, touch and hold the **EXIT** button.
Return to the top screen.

Selecting a Tone with the Touch Buttons



With each touch of the tone buttons, the first tone of each tone category is selected in turn.

Selecting a Tone with the F Buttons

1. Select the “07 Piano Collect” or “08 E.PianoCollect” of the F button set. See “To change the F Button Set” (page EN-32).



2. Touch one of the **F1** to **F4** buttons, to select the tone you want.

- The tones in the table below can be selected with a single touch.

	07 Piano Collect	08 E.PianoCollect
F1 button	001 Privia GRAND	018 SPACE BOY EP
F2 button	004 STAGE PIANO	019 JUST THE WAY EP
F3 button	005 BALLAD PIANO	023 INDESTRUCTIBLE EP
F4 button	009 COOL GRAND	024 WHERE IT IS EP

NOTE

- You can assign your own favorite tones to each F button using the F button set for which functions have not yet been assigned. For more information, see “Using the F Button Set” (page EN-94).

Guitar and Bass Tones

The built-in guitar and bass tones may contain strum noise, ghost notes, or other sound effects depending on the sound (pitch and intensity). For more information, refer to the separate “Built-in Music Data Lists”.

Sounding Two Different Tones at the Same Time (Layer)

As shown in the figure below, by assigning different tones to the “Upper 1” and “Upper 2” parts, two tones can be played simultaneously when the keyboard is played. This feature is called “Layer”. When Layer is turned on, both the Upper 1 and Upper 2 parts sound simultaneously.

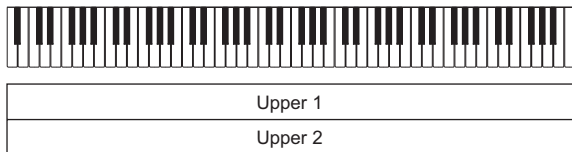

Layer: On, Split: Off*

* For details on Split, see “[Splitting the Keyboard Between Two Tones \(Split\)](#)” (page EN-46).

NOTE

- If you play the keyboard when both Layer and Split are off, only the Upper 1 part will sound.

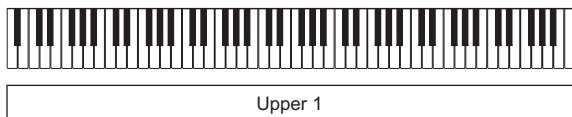

Layer: Off, Split: Off

Layering Two Tones

1. Perform the operation described in “[Selecting a Single Tone](#)” (page EN-41) operation to select the Upper 1 tone.
2. Select the “01 Standard” of the F button set. See “[To change the F Button Set](#)” (page EN-32).



3. Touch the **F4** button (LAYER).

Layer is turned ON and the **LY** indicator appears on the display.

Part name: U2 (Upper 2)

Displayed when Layer is on



4. Perform the operation described in “[Selecting a Single Tone](#)” (page [EN-41](#)) operation to select the Upper 2 tone.

Unlayering the Keyboard

1. Select the “01 Standard” of the F button set. See “[To change the F Button Set](#)” (page [EN-32](#)).
2. Touch the **F4** button (LAYER) to turn off the **LY** indicator on the display.

Splitting the Keyboard Between Two Tones (Split)

By assigning a “Lower” part to the lower range of the keyboard (as shown in the figure below), the lower range and upper range of the keyboard can play different tones. This function is called “Split”. With Split turned on, you can do the following.

- The lower (left side) range of the keyboard sounds the tone of the Lower part while the upper (right side) range of the keyboard sounds the tone of the Upper 1 part (when Layer is off*).



- The lower (left side) range of the keyboard sounds the tone of the Lower part while the upper (right side) range of the keyboard sounds the tone of the Upper 1 and Upper 2 parts (when Layer is on*).

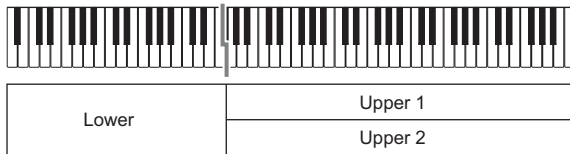

* For details on layering, see “[Sounding Two Different Tones at the Same Time \(Layer\)](#)” (page EN-44).

Splitting the Keyboard Between Two Different Tones

1. Perform the operation described in “[Selecting a Single Tone](#)” (page EN-41) operation to select the upper range tone (Upper 1 tone).
2. Select the “01 Standard” of the F button set. See “[To change the F Button Set](#)” (page EN-32).
3. Touch the **F3** button (SPLIT).
SPLIT is enabled and the **SP** indicator appears on the display.

Part name: L (Lower)

Displayed when SPLIT is on



4. Perform the operation described in “[Selecting a Single Tone](#)” (page EN-41) operation to select the lower range tone (Lower tone).

NOTE

- To use both SPLIT and LAYER at the same time, perform steps 3 to 4 of the above operation following the operation described in “[Layering Two Tones](#)” (page EN-44).

Changing the Split Point

Under initial default settings, the lowest note of the upper range (called the split point) is F#3.

1. Select the “01 Standard” of the F button set. See “[To change the F Button Set](#)” (page EN-32).
2. Touch and hold the **F3** button (SPLIT).
The “SPLIT POINT” screen appears.

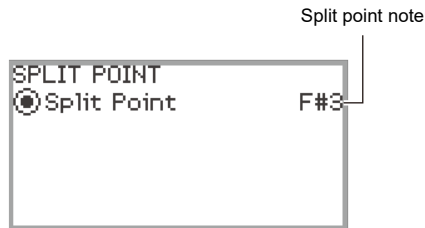

3. Press the keyboard key you want to be the split point (lowest note of the upper range).
The note of the split point is changed to that of the key pressed.
 - You can also change the split point using the touch ring or touching the **ENTER** button to display a list of note names.
4. Touch the **EXIT** button to exit the setup.

Unsplitting the Keyboard

1. Select the “01 Standard” of the F button set. See “[To change the F Button Set](#)” (page EN-32).
2. Touch the **F3** button (SPLIT) to turn off the SP indicator on the display.

Changing Part Settings (Volume Level, Octave Shift, Tuning, etc.)

You can change the volume, octave shift, tuning, and other settings for the Upper 1 and Upper 2 parts when using Layer (page [EN-44](#)), and the Lower part when using Split (page [EN-46](#)), individually for each part. For more information, see the references in the table below.

Configuration items	Reference
Volume of each part, stereo pan, Hall Simulator/Reverb, Chorus	“Using the Mixer” (page EN-65)
Octave shift for each part	“Changing the Pitch in Octave Units (Octave Shift)” (page EN-132)
Fine tuning of each part	“Adjusting the Tuning Separately for Each Part (Upper 1/Upper 2/Lower) (Part Fine Tune)” (page EN-131)
Enable/disable pedal operation for each part	“Enabling/Disabling the Pedal Operation for Each Part (Upper 1/Upper 2/Lower)” (page EN-71)
Enable/disable pitch bend wheel operation for each part	“Enabling/Disabling the Pitch Bend Wheel Operation for Each Part (Upper 1/Upper 2/Lower)” (page EN-80)

Applying Effects

Using the Sound Mode Effects (Hall Simulator/Reverb and Surround)

The “Sound Mode” of this Digital Piano includes the following effects.

• Hall Simulator/Reverb

Hall Simulator and Reverb are both effects that change the reverberation of the sound.

Hall Simulator	The hall simulator effect simulates the rich clarity, unconstrained brilliance, and other distinctive acoustic characteristics of world-famous concert halls and structures.
Reverb	Reverb simulates ambient spaces, such as a room or hall.

• Surround

A surround effect (an effect that adds breadth to the sound) is applied to the sound output from the built-in speakers.

NOTE

- The Surround effect is not applied to the output from the Digital Piano's **PHONES** jacks or **LINE OUT R, L/MONO** jacks.

Enabling or Disabling the Hall Simulator/Reverb and Surround Effects

Under initial default settings, the Hall Simulator/Reverb is on and Surround is off. Each can be turned on and off as follows.

1. Select the “04 Listening” of the F button set. See “To change the F Button Set” (page EN-32).
2. Touch the **F2** button (SMODE).
The “Sound Mode” screen appears.



3. Touch the top or bottom of the touch ring to change the setting value.

Setting value	Description
Off	Disables both effects
Hall/Rev.	Enables Hall Simulator/Reverb only
Surround	Enables Surround only
Hall/Rev. + Srnd	Enables both effects

Specifying the Hall Simulator/Reverb Type

Before selecting a Hall Simulator/Reverb type, make sure to enable the Hall Simulator/Reverb. For details, see “[Enabling or Disabling the Hall Simulator/Reverb and Surround Effects](#)” (page EN-49).

NOTE

- The “SOUND MODE” screen shown in step 2 can also be displayed by touch and hold the F button to which “SMODE” is assigned.

1. Touch the **FUNCTION** button to display the **FUNCTION** menu.
2. Use the touch ring to select “**SOUND**” > “**SOUND MODE**” > “**Hall/Rev. Type**”.

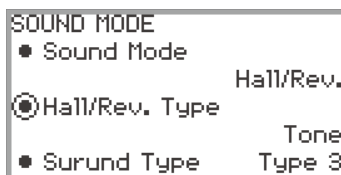

3. Trace the touch ring to change the setting value.

Setting value	Description
Tone	The type is automatically set to match the selected tone.
Salon N.Y. Club Scoring Stage Opera Hall Viennese Hall L.A. Hall Berlin Hall BritishStadium	Various types of hall simulator. For example, “N.Y. Club” simulates the acoustics of a music club in Manhattan, while “Berlin Hall” simulates a classical arena-style concert hall in Berlin.
Room 1 Room 2 Room 3 Large Room	Simulates the reverberation of a room.
Hall 1 Hall 2 Hall 3	Simulates the reverberation of a small hall.
Stadium	Simulates the reverberation of a stadium.

Adjusting the Depth of the Hall Simulator/Reverb Effect

The mixer can be used to individually adjust the Hall Simulator/Reverb for each part (Upper 1/Upper 2/Lower), audio input from the **MIC IN** jack, etc. For more information, see “Using the Mixer” (page EN-65).

Specifying the Surround Type

Before selecting the Surround type, make sure to enable Surround. For details, see “Enabling or Disabling the Hall Simulator/Reverb and Surround Effects” (page EN-49).

NOTE

- The “SOUND MODE” screen shown in step 2 can also be displayed by touch and hold the F button to which “SMODE” is assigned.

1. Touch the **FUNCTION** button to display the **FUNCTION** menu.
2. Use the touch ring to select “SOUND” > “SOUND MODE” > “Surund Type”.

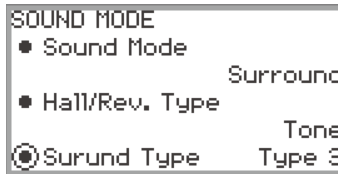

3. Trace the touch ring to change the desired setting value.
 - You can choose from Type 1 (small effect), Type 2 (medium effect), and Type 3 (large effect).*
 - * Depending on the tone selected and the characteristics of the audio being played back, the effect may not be obvious.

Using DSP Effects

The Digital Piano's DSP (Digital Signal Processor) can be used to apply various effects to the built-in tones. Effects include equalizer, tremolo, limiter, wah-wah, among others.

Preset DSPs

This Digital Piano is equipped with 100 preset DSP effects. These effects can be applied to any of the built-in tones, and the effect settings adjusted as you like.

DSP Tones

DSP effects can be switched ON (enabled) or OFF (disabled) for each tone. Some DSP effects are preset to ON or OFF depending on the built-in tone. For tones that use DSP effects, a preset appropriate for the tone is assigned as the default DSP. This is called a "DSP tone."

NOTE

- To check whether a particular tone is a DSP tone, refer to "Tone Lists" in the separate "Built-in Music Data Lists".

Enabling or Disabling DSP

1. Perform the operation described in "[Selecting a Single Tone](#)" (page EN-41) operation to select a tone.
2. Select the "10 Effect" F button set. See "[To change the F Button Set](#)" (page EN-32).
3. Touch the F4 button (DSP).

DSP is enabled and the F button menu F4 appears enclosed in brackets [].

Displayed when DSP is enabled

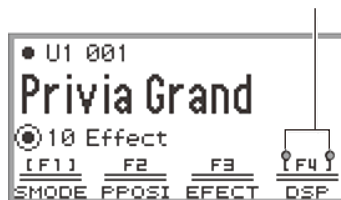

4. To disable DSP, touch the F4 button (DSP). The enclosing brackets [] disappear.

Selecting a DSP Type

To quickly switch the DSP effect type applied to a tone, select one of the “Preset DSPs” (DSP type numbers 001 to 100) using the following operation:

1. Perform the operation described in “[Selecting a Single Tone](#)” (page [EN-41](#)) operation to select a tone.
2. Select the “10 Effect” F button set. See “[To change the F Button Set](#)” (page [EN-32](#)).
3. Touch and hold the F4 button (DSP).
The “DSP” screen appears.

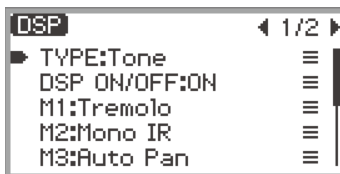

4. Touch the **ENTER** button to display the “DSP TYPE” screen.
5. Use the touch ring to select the type of DSP you want.
 - “000 Tone” is the default DSP type for each tone.
 - “001 Mono 1BandEQ” and after are “Preset DSPs” with their own names, such as equalizer or compressor. See “[Preset DSP List](#)” (page [EN-184](#)) for details on the name and configuration of each preset DSP.

Configuring DSP Settings

The DSP of this Digital Piano consists of up to four modules (M1–M4) as shown in the figures below.

- In the case of a single module:



- In the case of four modules:



- Each module can contain various effects (equalizer, tremolo, compressor, etc.).
- Each DSP type has a specific module configuration (number of modules and effects inside). For more information, see “[Preset DSP List](#)” (page [EN-184](#)).

When changing the DSP settings, adjust the parameters of the effects contained in each module.

■ To change DSP settings

Use the “DSP” screen to change DSP settings.

IMPORTANT!

- Note that any changes you make to DSP settings are cleared whenever you change the tone or turn off Digital Piano power. If you want to retain DSP changes you make, use the registration function (page EN-86) to save the setup so you can recall it later.

1. Perform the operation described in “[Selecting a Single Tone](#)” (page EN-41) operation to select a tone.
 - If you want to change the default DSP of a DSP tone (page EN-52), select the DSP tone here.
2. Select the “10 Effect” F button set. See “[To change the F Button Set](#)” (page EN-32).
3. Touch and hold the F4 button (DSP).
The “DSP” screen appears.

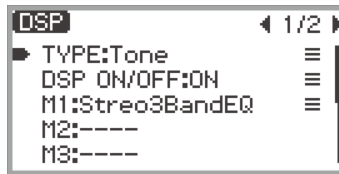

4. Touch the **ENTER** button to display the “DSP TYPE” screen.



5. Use the touch ring to select the type of DSP for which you want to change the settings.
 - If you want to change the default DSP settings of the tone you selected in step 1, select “000 Tone”.
 - If you want to change settings of a preset DSP that is applied to the tone you selected in step 1, select one from “001 Mono 1BandEQ” to “100 Stereo IR+EQ”.
 - After making your selection, touch the **EXIT** button to return to the “DSP” screen.

6. If DSP ON/OFF:OFF is displayed, switch it to ON by the following operation.

- (1) Use the touch ring to select "DSP ON/OFF:OFF" and touch the **ENTER** button.
- (2) Use the touch ring to set the value to "On".
- (3) Touch the **EXIT** button to return to the "DSP" screen.

7. Use the touch ring to select the module (from "M1" to "M4") whose settings you want to change, and touch the **ENTER** button.

A list of parameters for the effect in the selected module is displayed.



- "Bypass" is common to all modules. Set to "On" if you do not want to use the effect in the currently displayed module. For more information, see "[About Bypass](#)" (page [EN-56](#)).

8. Change the parameter settings.

- (1) Touch the top or bottom of the touch ring to select the parameter you want to change.
- (2) Use the touch ring to change the value of the selected parameter.

For parameters and values, see "[Parameter List of DSP Module Effects](#)" (page [EN-189](#)).

- (3) Repeat steps (1) and (2) as many times as necessary.
- (4) Touch the **EXIT** button to return to the "DSP" screen.

9. If necessary, adjust other parameters in the other modules in the same way following steps 7 to 8.

10. When all necessary settings have been made, touch and hold the **EXIT** button to return to the top screen.

11. If you want to save the modified settings, follow the operation described in "[Saving a Setup Registration](#)" (page [EN-87](#)) to save the registration.

■ About Bypass

All modules contain a “Bypass” parameter. When set to “Off” (default), the effects in that module are enabled. When set to “On”, the module is “bypassed” from the line connecting the sound source to the output, disabling the effects in the module.

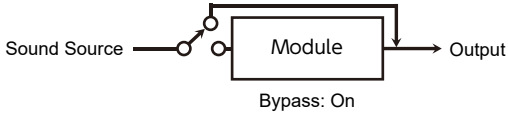
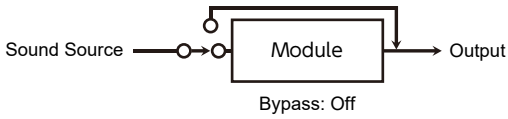

If there is a module with unnecessary effects in a DSP consisting of multiple modules, set “Bypass” to “On” for that module.

Using Chorus (Chorus, Flanger, Short Delay)

The chorus effect thickens the sound.

Changing the Chorus Type

This Digital Piano has a preset chorus effect assigned to each tone, but you can select a different type by following the operation below.

1. Select the “09 Favorite Piano” of the F button set. See “To change the F Button Set” (page EN-32).

2. Touch the F2 button (EFFECT).

The “EFFECT” screen appears.

- Check that the cursor (○) is on the “Chorus Type”.

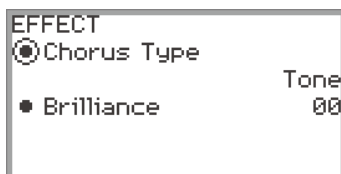

3. Change the value of the “Chorus Type” setting.

Setting value	Description
Tone	The chorus type is automatically set to match the selected tone.
Chorus 1 to 4	Four chorus types with different characteristics.
FB Chorus	Chorus with feedback.
Deep Chorus	Chorus with the deepest, thickest sound.
Flanger 1 to 4	Four types of flanger with different sound undulations and fluctuations.
Short Delay 1, 2	Short delay. There are two types to choose from.

- Use the touch ring to change the desired setting value.

Adjusting the Depth of the Chorus Effect

The mixer can be used to adjust the chorus applied to each part (Upper 1/Upper 2/Lower) separately. For more information, see “Using the Mixer” (page EN-65).

Adjusting Brilliance

Brilliance is an effect that adjusts the brightness of a sound.

NOTE

- The brilliance effect is applied to the entire sound output from the Digital Piano.

1. Select the “09 Favorite Piano” of the F button set. See “[To change the F Button Set](#)” (page EN-32).
2. Touch the **F2** button (EFFECT).
The “EFFECT” screen appears.
3. Touch the top or bottom of the touch ring to select “Brilliance”.

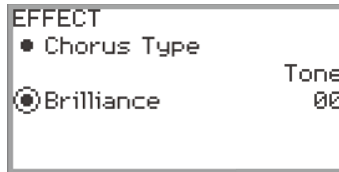

4. Change the “Brilliance” setting.
 - Use the touch ring to change the desired setting.
 - You can adjust the setting between -12 and $+12$. When $+1$ or higher, the sound is brighter; when -1 or lower, the sound is darker.

Adjusting Acoustic Piano Sound Characteristics (Acoustic Simulator)

The piano tones of this Digital Piano include elements characteristic of the sound of an acoustic piano. Follow the procedure below to adjust them.

1. Select the “09 Favorite Piano” of the F button set. See “[To change the F Button Set](#)” (page EN-32).
2. Touch the **F1** button (ACSIM).
The “ACOUSTIC SIM.” screen will appear.

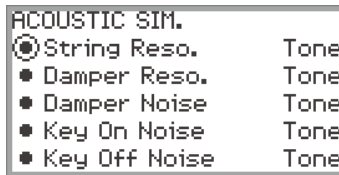

3. Touch the top or bottom of the touch ring to select the item whose settings you want to change.
 - For more information on each setting item, see “[List of Acoustic Piano Sound Setting Items](#)” (page EN-60).
4. Changes the setting value of the selected item.
 - The setting value of each item can be changed within the following range.

Setting value	Description
Tone	A value appropriate for the selected tone is automatically set.
Off	Turn off the effect.
1 to 10	The higher the number, the stronger the effect.

- Trace the touch ring to change the desired setting value.

5. Repeat steps 3 and 4 as necessary.

List of Acoustic Piano Sound Setting Items

Setting Items	Description
String Reso.	String Resonance. Playing on an acoustic piano causes the strings that are harmonics of the played strings to resonate. You can use this setting item to adjust the level of resonance.
Damper Reso.	Damper Resonance. Pressing the damper pedal on an acoustic piano opens all the strings of 88 keys, causing all of the strings that are harmonics of the keys that are played to resonate. You can use this setting item to adjust the level of resonance.
Damper Noise	Damper Noise. Damper noise is a slight metallic ringing sound that is generated as the damper of an acoustic piano separates from the strings when the damper pedal is pressed. You can use this setting item to adjust the volume level of the noise.
Key On Noise	Key On Action Noise. When the keys of an acoustic piano are tapped with extremely light pressure, piano mechanism operation sound (noise) is produced without the hammers reaching the strings. You can use this setting item to adjust the volume level of the noise.
Key Off Noise	Key Off Action Noise. Releasing the keyboard keys of acoustic piano generates piano mechanism operation sound (noise). You can use this setting item to adjust the volume level of the noise.

Using Microphone Effects

Various effects can be applied to the audio from a microphone connected to the **MIC IN** jack. In addition to the 25 preset types, you can change the effect settings to your liking.

NOTE

- You can also adjust settings for the volume, stereo pan, and Hall Simulator/Reverb applied to audio input from the **MIC IN** jack. For more information, see “Using the Mixer” (page EN-65).

Enabling or Disabling the Microphone Effect

- Select the “05 Song Play” of the F button set. See “To change the F Button Set” (page EN-32).
- Touch the **F4** button (MICFX).
The microphone effect is enabled and the F button menu F4 appears enclosed in brackets [].

Displayed when the microphone effect is enabled



- To disable the microphone effect, touch the **F4** button (MICFX). The enclosing brackets [] disappear.

Specifying the Microphone Effect Type

1. Select the “05 Song Play” of the F button set. See “[To change the F Button Set](#)” (page [EN-32](#)).
2. Touch and hold the **F4** button (MICFX).
The “MIC FX” screen appears.

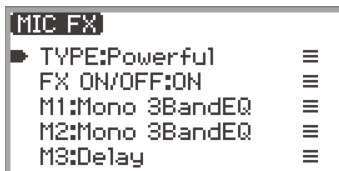

3. Touch the **ENTER** button to display the “MIC FX TYPE” screen.

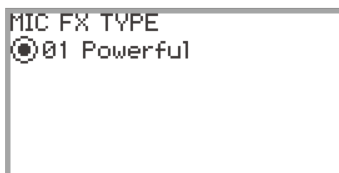

4. Use the touch ring to select the type of microphone effect.
 - There are 25 effect types to choose from. For more information, see “[Microphone Effect Type List](#)” (page [EN-226](#)).

Changing Microphone Effect Settings

The microphone effect is made up of three modules (M1 to M3) as shown in the figure below.



- Each module contains different effects (equalizer, delay, limiter, etc.).
- Each type of microphone effect has a specific set of effects in each module. For more information, see “Microphone Effect Type List” (page EN-226).

To change microphone effect settings, adjust the parameters of the effect inside each module.

IMPORTANT!

- Settings changed by the following operations will be erased when the Digital Piano is turned off. If you want to save the modified settings, use the registration function (page EN-86) to save them.

1. Select the “05 Song Play” of the F button set. See “To change the F Button Set” (page EN-32).
2. Touch and hold the **F4** button (MICFX).
The “MIC FX” screen appears.

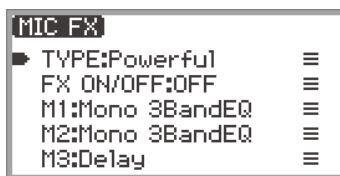

3. Touch the **ENTER** button to display the “MIC FX TYPE” screen.
4. Use the touch ring to select the type of microphone effect for which you want to change the settings.
 - After making your selection, touch the **EXIT** button to return to the “MIC FX” screen.
5. If “FX ON/OFF:OFF” is displayed, switch it to ON by the following operation.
 - (1) Use the touch ring to select “FX ON/OFF:OFF” and touch the **ENTER** button.
 - (2) Use the touch ring to set the value to “On”.
 - (3) Touch the **EXIT** button to return to the “MIC FX” screen.

6. Use the touch ring to select the module (from “M1” to “M3”) whose settings you want to change, and touch the **ENTER** button.

A list of parameters for the effect in the selected module is displayed.

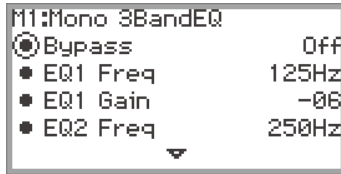

- “Bypass” is common to all modules. Set to “On” if you do not want to use the effect in the currently displayed module.

7. Change the parameter settings.

- (1) Touch the top or bottom of the touch ring to select the parameter you want to change.
- (2) Use the touch ring to change the value of the selected parameter.
For parameters and values, see “[Parameter List of Module Effects](#)” (page [EN-228](#)).
- (3) Repeat steps (1) and (2) as many times as necessary.
- (4) Touch the **EXIT** button to return to the “MIC FX” screen.

8. If necessary, adjust other parameters in the other modules in the same way following steps 6 to 7.

9. When all necessary settings have been made, touch and hold the **EXIT** button to return to the top screen.

10. If you want to save the modified settings, follow the operation described in “[Saving a Setup Registration](#)” (page [EN-87](#)) to save the registration.

Using the Mixer

The mixer allows you to individually adjust the volume, stereo pan, and effects for each part (Upper 1/ Upper 2/Lower) and audio input from the **MIC IN** jack.

Adjusting the Volume Level, Stereo Pan and Effects for Each Part

1. Select the “04 Listening” of the F button set. See “[To change the F Button Set](#)” (page [EN-32](#)).

2. Touch the **F4** button (**MIXER**).

The “MIXER” screen appears. This screen contains four parameter categories.

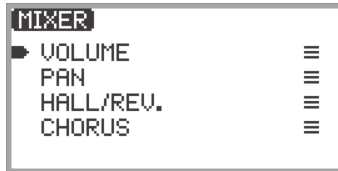

VOLUME: Adjust volume

PAN: Adjust stereo pan (pan)

HALL/REV.: Adjust the depth of the Hall Simulator/Reverb effect

CHORUS: Adjust the depth of the chorus effect

3. Use the touch ring to select the parameter category you want to adjust then touch the **ENTER** button.

- For example, if you select “VOLUME” and touch the **ENTER** button, the following screen will appear.

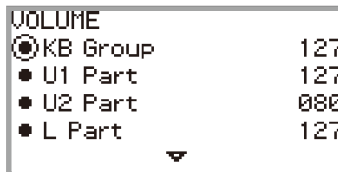

4. Touch the top or bottom of the touch ring to select the item whose value you want to change.

5. Change the value of the selected item.

- Trace the touch ring to change the value.
- For more information on items and values, see “[List of Mixer Setting Items](#)” (page [EN-66](#)).

6. When done, touch the **EXIT** button to return to the “MIXER” screen.

7. Repeat steps 3 to 6 as necessary.

List of Mixer Setting Items

Parameter Category	Setting items	Description	Range of values
VOLUME	KB Group	Adjusts the overall volume of the Upper 1, Upper 2, and Lower parts while maintaining their relative volumes.	000 to 127
	U1 Part U2 Part L Part	Adjusts the individual volume of the Upper 1, Upper 2, and Lower parts.	
	Audio Song	Adjusts the volume of audio data played in SONG mode (page EN-106).	
	Wireless Audio	Adjusts the volume of input audio from wirelessly connected external devices.	
	Mic In	Adjusts the volume of the input audio from the MIC IN jack.	
	MIDI Song	Adjusts the volume of MIDI data played in SONG mode (page EN-106).	
PAN	U1 Part U2 Part L Part	Adjusts the stereo pan of the Upper 1, Upper 2, and Lower parts.	-64 to 00 to +63 -64: Left-most 00: Central +63: Right-most
	Mic In	Adjusts the stereo pan of input audio from the MIC IN jack.	
HALL/REV.	Hall/Rev. Return	Adjusts the overall depth (Return value) while maintaining the balance of the currently set Hall Simulator/Reverb depth (Send value) for each part of the following items (U1 Part Send - Mic In Send).	000 to 127
	U1 Part Send U2 Part Send L Part Send	Adjusts the Send value to the Hall Simulator/Reverb for the Upper 1, Upper 2, and Lower parts.	
	AudioSongSend	Adjusts the Send value to the Hall Simulator/Reverb for audio data played in SONG mode (page EN-106).	
	Wireless A Send	Adjusts the Send value of input audio from a wirelessly connected external device to the Hall Simulator/Reverb.	
	Mic In Send	Adjusts the Send value of the input audio from the MIC IN jack to the Hall Simulator/Reverb.	
CHORUS	U1 Part Send U2 Part Send L Part Send	Adjusts the Send value to the chorus for the Upper 1, Upper 2, and Lower parts.	000 to 127

Changing the Sound During a Performance

Using Pedals

This Digital Piano is equipped with two jacks for pedal connections. Pedals can be connected to both jacks and used at the same time.

Jack	Connectable Pedal
PEDAL UNIT	Separately available pedal unit (three pedals: damper, soft, and sostenuto)
EXPRESSION/ASSIGNABLE	Commercially available expression pedal, the included sustain pedal (SP-3), separately available sustain pedal

PEDAL UNIT jack

Use the **PEDAL UNIT** jack to connect a separately available pedal unit. You can then use the pedals for expression that is similar to that available on an acoustic piano.

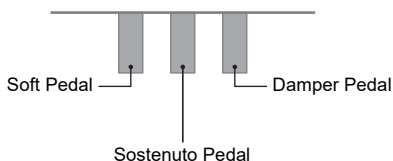

Damper Pedal

Pressing the damper pedal while playing will cause the notes you play to be sustained.

- When Grand Piano is selected as the tone, using this pedal generates harmonic and other resonance, just like the damper pedal on an acoustic grand piano. The strength of the pedal's effect varies continuously with the depth to which you depress the pedal.

Soft Pedal

Pressing this pedal while playing suppresses notes played on the keyboard after the pedal was pressed, and makes them sound softer.

Sostenuto Pedal

Only the notes of the keys that are depressed when this pedal is pressed are sustained, even if the keyboard keys are released, until the pedal is released.

EXPRESSION/ASSIGNABLE jack

Use the **EXPRESSION/ASSIGNABLE** jack to connect the included sustain pedal (SP-3), a commercially available expression pedal or a separately available sustain pedal.

■ Connectable Expression Pedals

- Maximum resistance value: 10kΩ±20% to 50kΩ±20%
- Use of a pedal whose operation has been confirmed (see below) is recommended.

Operation Confirmed Pedals (Polarity Type 2*)

Roland EV-5 (Set minimum volume to 0.)

KURZWEIL CC-1

FATAR VP-25, VP-26

* Use the procedure under “To specify the pedal type” (page EN-68) to select “Exp.Type2”.

■ To specify the pedal type

1. Select the “13 KB Setting” of the F button set. See “To change the F Button Set” (page EN-32).

2. Touch the **F3** button (PEDAL).

The “EXP/ASGN. PEDAL” screen appears.

- Confirm that the cursor (○) is on “Pedal Type”.

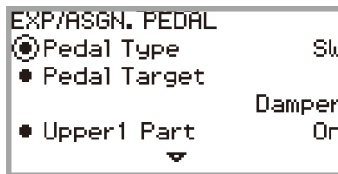

3. Use the touch ring to change the desired setting.

- The polarity of expression pedals varies by manufacturer. When connecting an expression pedal, select “Exp.Type1” or “Exp.Type2” according to the polarity of the pedal.

Setting value	Description
Exp.Type1	Polarity Type 1 (see the illustration below) expression pedal
Exp.Type2	Polarity Type 2 (see the illustration below) expression pedal
SW	The included sustain pedal (SP-3) or a separately available sustain pedal

■ To specify the pedal function

Display the “EXP/ASGN. PEDAL” screen by performing the procedure under “[To specify the pedal type](#)” (page [EN-68](#)) and change the value of the “Pedal Target” setting. The following setting values are for the expression pedal only: “Expression”, “Master Vol”, “Tempo”, and “LY Balance”.

NOTE

- The “EXP/ASGN. PEDAL” screen can also be displayed by touching and holding the **FUNCTION** button and depressing a pedal connected to the **EXPRESSION/ASSIGNABLE** jack (if the connected pedal matches the currently selected pedal type).

Setting value	Description
Expression	Controls Expression (MIDI Control Change 11).
Master Vol	Controls overall Digital Piano volume level.
Tempo	Controls tempo.
LY Balance	Controls Upper 1 part and Upper 2 part volume level balance.
Damper	Sustains notes played while the pedal is depressed, even if the keys are subsequently released. Organ and other tones that are sustained as long as keys are depressed continue to sound as long as the pedal is depressed.
Sostenuto	Sustains only the notes of the keys that are depressed when the pedal is pressed until the pedal is released, even if the keyboard keys are released first.
Soft	While the pedal is depressed, slightly lowers the volume of notes played and also softens them.
Arpeggio Hold	When the Arpeggiator (page EN-84) is enabled, Arpeggio Hold can be enabled or disabled when the pedal is depressed.
Start/Stop	Performs the same operations as the  button.
Seq Recall Inc Seq Recall Dec	Each press of a pedal scrolls through and selects setups you registered with the registration function. For more information, see “ Using a Pedal to Cycle Through Multiple Setup Registrations (Sequential Recall) ” (page EN-91).

■ Expression Pedal Calibration

When connecting an expression pedal to the **EXPRESSION/ASSIGNABLE** jack for the first time, perform calibration (adjustment) as follows.

1. Connect an expression pedal to the **EXPRESSION/ASSIGNABLE** jack.
2. Select the “13 KB Setting” of the F button set. See “[To change the F Button Set](#)” (page [EN-32](#)).
3. Touch the **F3** button (PEDAL).
The “EXP/ASGN. PEDAL” screen appears.
4. Touch the top or bottom of the touch ring to select “Exp Calibration” then touch the **ENTER** button.
A confirmation screen will appear. To cancel the operation, touch the left (NO) of the touch ring.



5. To start calibration, touch the right (YES) of the touch ring.
6. When “Highest” is displayed, press the toe end of the pedal down as far as it will go, then touch the **ENTER** button.
7. When “Lowest” is displayed, press the heel end of the pedal down as far as it will go, then touch the **ENTER** button.
When calibration has successfully completed, “Complete” is displayed.

Enabling/Disabling the Pedal Operation for Each Part (Upper 1/Upper 2/Lower)

1. Touch the **FUNCTION** button to display the **FUNCTION** menu.
2. Use the touch ring to select “PEDAL/WHEEL” then touch the **ENTER** button.
3. Select from the menu the jack to which the pedal whose settings you want to change is connected.
 - To change the settings of the pedal connected to the **PEDAL UNIT** jack: Use the touch ring to select “PEDAL UNIT” then touch the **ENTER** button.

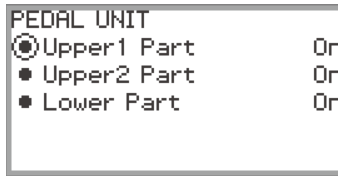

- To change the settings of the pedal connected to the **EXPRESSION/ASSIGNABLE** jack: Use the touch ring to select “EXP/ASGN. PEDAL” then touch the **ENTER** button.

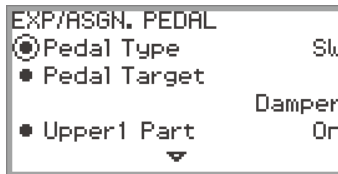

4. Touch the top or bottom of the touch ring to select “Upper 1 Part”, “Upper 2 Part”, or “Lower Part”
5. Use the touch ring to change the desired setting.
 - Select “On” to enable pedal operation for the part selected in step 4 or “Off” to disable it.
6. Repeat steps 4 and 5 as necessary.

Using the Knobs

The two knobs are used by assigning different functions to each. Assignable functions include modifying tones, adjusting effects, or controlling the volume of specific parts. By turning the knobs, the parameter values of the assigned functions can be changed in real time while playing.

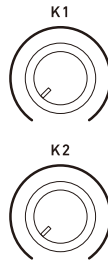

Using the Knobs to Change Parameters

Under initial default settings, the functions that modifies the frequency characteristics of your performance sound are assigned to each of the knobs as follows: **K1** knob: Cutoff Freq., **K2** knob: Resonance. The operation below shows an example of knob usage under initial default settings.

1. Rotate the **K1** knob.

This temporarily displays the function name “CUTOFF FREQ.” that is currently assigned to the **K1** knob. The parameter value changes in accordance with the position of the **K1** knob.



2. Rotate the **K2** knob.

This temporarily displays the function name “RESONANCE” that is currently assigned to the **K2** knob. The parameter value changes in accordance with the position of the **K2** knob.



Changing the Function Assigned to a Knob

1. Select the “12 Control” F button set. See “[To change the F Button Set](#)” (page [EN-32](#)).
2. Touch the **F3** button (KNOB).
The “KNOB” screen appears.

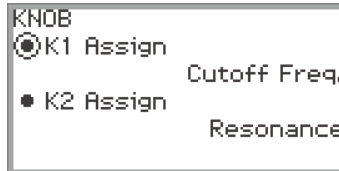

3. Touch the top or bottom of the touch ring to select the item whose setting value you want to change.
 - Select “K1 Assign” to change the function of the **K1** knob or “K2 Assign” to change the function of the **K2** knob.
4. Use the touch ring to select the function you want to assign to the knob.
 - For more information, see “[List of Assignable Functions to the Knobs](#)” (page [EN-74](#)).
5. Repeat steps 3 and 4 as necessary.

NOTE

- Instead of steps 1 and 2 above, the “KNOB” screen can also be displayed by rotating the **K1** or **K2** knob while touching the **FUNCTION** button. (If the **K1** knob is rotated, “K1 Assign” is selected; if the **K2** knob is rotated, “K2 Assign” is selected.)

■ List of Assignable Functions to the Knobs

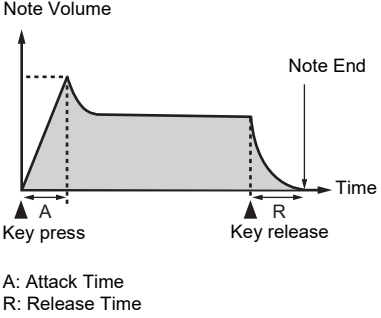
Function	Category*1	Description
Cutoff Freq.	Knob/CTRL	Adjusts timbre by attenuating the components of a note's frequency characteristics that are higher than a certain frequency (cutoff frequency). A larger value specifies a brighter, harder sound, while a lower value specifies a mellower, softer sound.
Resonance	Knob/CTRL	Adjusts the degree to which the gain of the overtone component is increased near the frequency specified by "Cutoff Freq." above. A larger value specifies a more unusual sound.
Modulation	Knob/CTRL	Adjusts the level of the modulation effect.
Brilliance	Effect	Adjusts the brightness of a sound.
Hall/Rev. Send	Mixer	Adjusts the send value to the Hall Simulator/Reverb for the Upper 1 part.
Chorus Send	Mixer	Adjusts the send value to the chorus for the Upper 1 part.
Attack Time	Knob/CTRL	Adjusts the time after a key is pressed from when the note starts to sound until it reaches maximum volume. A larger value specifies a slower attack.  <p>A: Attack Time R: Release Time</p>
Release Time	Knob/CTRL	Adjusts how long notes linger after keyboard keys are released. A larger value specifies a longer release.
Vibrato Rate	Knob/CTRL	Adjusts the speed of vibrato of a tone.
Vibrato Depth	Knob/CTRL	Specifies the depth of vibrato of a tone.
Delay Vib Time	Knob/CTRL	Adjusts the time until the vibrato of the tone starts after a note is sounded.
Portamento Time	Tone	Adjusts the duration of the portamento notes.
Layer Balance	Mixer	Adjusts the Upper 1 part and Upper 2 part volume level balance.
Upper1 Pan	Mixer	Adjusts the stereo pan of the Upper 1 part.
Upper2 Fine Tune	Tone	Adjusts the part fine tune of the Upper 2 part.

Function	Category*1	Description
Upper2 Pan	Mixer	Adjusts the stereo pan of the Upper 2 part.
Lower Volume	Mixer	Adjusts the volume of the Lower part.
Lower Pan	Mixer	Adjusts the stereo pan of the Lower part.
KB Hall/Rev. Send	Mixer	Adjust the send value to the Hall Simulator/Reverb for all the keyboard parts (Upper 1, Upper 2, and Lower).
KB Chorus Send	Mixer	Adjust the send value to the chorus for all the keyboard parts (Upper 1, Upper 2, and Lower).
KB Group Volume	Mixer	Adjust the group volume level of the keyboard parts (Upper 1, Upper 2, and Lower).
MIDISongVolume	Mixer	Adjusts playback volume level of the MIDI song data.
DSP Parameter 1	Tone	Adjusts DSP parameters. The target parameters for adjustment changes in accordance with the DSP type that is currently selected.*2
DSP Parameter 2	Tone	
WirelesAudioVol	Mixer	Adjusts the volume of input audio from wirelessly connected external devices.
Audio Song Vol.	Mixer	Adjusts playback volume level of the audio song data.
Arpeg Note Len	Arpeggiator	Adjusts the arpeggiator note lengths.
Upper Pan Bal.	Mixer	Adjusts the Upper 1 part and Upper 2 part stereo pan balance.
Off	—	Disables knob functions.

*1 This column shows the names of parameters included in the “FREEZE” screen of the registration function (page EN-90).

*2 The parameters affected by DSP Parameter 1 and DSP Parameter 2 are two parameters that are automatically selected as being the most applicable to the currently selected DSP. DSP Parameter 1 and DSP Parameter 2 are fixed according to the selected DSP. For example, when preset DSP “15. Auto Pan” is selected, DSP Parameter 1 is Rate, and DSP Parameter 2 is Manual.

Resetting the Parameters of the Functions Currently Assigned to the Knobs

1. Select the “12 Control” F button set. See “[To change the F Button Set](#)” (page [EN-32](#)).

2. Touch and hold the **F3** button (**KNOB**).

A confirmation screen will appear. To cancel the operation, touch the left of the touch ring (**NO**) at this point.



3. To reset, touch the right of the touch ring (**YES**).

“Complete” appears, and the display returns to the screen shown in Step 1.

Using the CONTROL Button

This button is used to control the sound while playing.

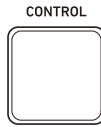

Under initial default settings, modulation is applied while the **CONTROL** button is held down. By changing the setting, other functions can be assigned, such as switching portamento (an effect that smoothly glides between notes) on and off.

Selecting the Function Assigned to the CONTROL Button

1. Select the “12 Control” of the F button set. See “To change the F Button Set” (page EN-32).

2. Touch the **F4** button (CTRL).

The “CONTROL” screen appears.

- Confirm that the cursor (○) is on “Control Assign”.

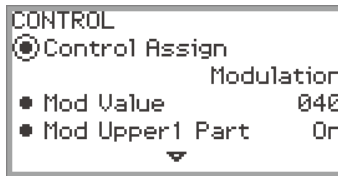

3. Use the touch ring to change the setting value.

Setting value	Description
Modulation	Modulation is applied while the CONTROL button is held down.
Portamento	Each press of the CONTROL button toggles the portamento of the Upper 1 part on/off.
Rotary	When a DSP tone* that uses the rotary effect is selected, each press of the CONTROL button toggles the rotary speaker setting between Slow and Fast.
Arpeg Note Len	Each press of the CONTROL button toggles the arpeggiator note lengths between normal and half.

* A “DSP tone” is a tone that includes a preset DSP effect. Please refer to the separate “Built-in Music Data Lists” for a list of tones with built-in DSP effects.

The DSP tones that include the rotary effect are organ tones numbered 61, 62, 65, 66, 67, 71, 72, 73, 74, 75, 76, 79, 80, 81.

4. If “Control Assign” is set to “Modulation”, change the modulation settings as necessary.

- Touch the top or bottom of the touch ring to set each item, such as “Mod Value”. For more information, see [“To change the Modulation settings”](#) (page EN-78).

NOTE

- The “CONTROL” screen can also be displayed by pressing the **CONTROL** button while touching the **FUNCTION** button instead of steps 1 and 2 above.
- When “Control Assign” is set to “Portamento”, the duration of the portamento can be changed using the knob. Assign “Portamento Time” as the function of the knob. For details, see [“Changing the Function Assigned to a Knob”](#) (page EN-73).

■ To change the Modulation settings

The settings shown in the table below, which appear in the “CONTROL” screen of [“Selecting the Function Assigned to the CONTROL Button”](#) (page EN-77), can be used to change the settings when modulation is assigned to the **CONTROL** button.

Setting item	Values	Description
Mod Value	000 to 127	Sets the intensity at which modulation is applied.
Mod Upper1 Part Mod Upper2 Part Mod Lower Part	On, Off	Selects whether to apply modulation to the Upper 1/Upper 2/Lower parts (On) or not (Off).

Using the Pitch Bend Wheel

By moving the pitch bend wheel up and down, the pitch of the currently sounding notes can be smoothly raised or lowered, producing an effect similar to saxophone or electric guitar pitch bending techniques.

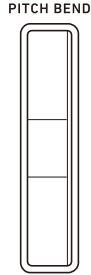

NOTE

- The pitch of the sound changes with the amount the wheel is moved.
- Do not touch the wheel when turning on the Digital Piano.

Changing the Pitch Bend Range

You can adjust the amount of pitch change that happens when the wheel is moved to the upper or lower limit in semitone steps. For example, when set to “2”, the pitch rises 2 semitones when the wheel is moved to the upper limit and falls 2 semitones at the lower limit.

1. Select the “13 KB Setting” of the F button set. See “[To change the F Button Set](#)” (page [EN-32](#)).
2. Touch the **F2** button (**WHEEL**).
The “WHEEL” screen appears.
 - Confirm that the cursor (○) is on “P Bend Range”.

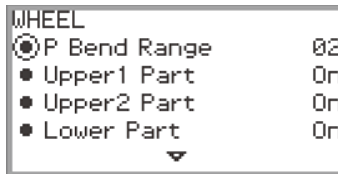

3. Change the value of the “P Bend Range” setting.
 - Set between 0 and 24.

Enabling/Disabling the Pitch Bend Wheel Operation for Each Part (Upper 1/ Upper 2/Lower)

Display the “WHEEL” screen by performing the operation under “[Changing the Pitch Bend Range](#)” (page [EN-79](#)) then adjust the settings below.

Setting item	Values	Description
Upper1 Part Upper2 Part Lower Part	On, Off	Enables (On) or disables (Off) the pitch bend wheel operation for the Upper 1/Upper 2/Lower parts.

Using the Metronome

The Digital Piano's metronome can play a variety of drum patterns in addition to a standard metronome sound.

Starting or Stopping the Metronome

1. While touching the **FUNCTION** button, touch the **▶/■** button.

The metronome starts.

- The red and white LEDs to the left of the **▶/■** button will flash in time with the metronome beat (first beat: red; remaining beats: white).

2. To stop the metronome, while touching the **FUNCTION** button touch the **▶/■** button.

Changing the Metronome Settings (Tempo, Beat, Pattern, etc.)

1. Select the “01 Standard” of the F Button Set. See “[To change the F Button Set](#)” (page [EN-32](#)).

2. Touch the **F2** button (**METRO**).

The “METRONOME” screen appears.

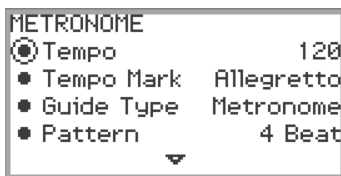

3. Touch the top or bottom of the touch ring to select the setting you want to change.

- The table below shows the available settings and values.
- The Tempo setting and Tempo Mark setting are linked to each other.

Setting item	Setting value and description
Tempo	Sets the tempo between 20 and 255 (BPM).
Tempo Mark	Sets the tempo from a tempo marking such as “Andante” or “Allegro”. For more information, see “ Tempo Markings ” (page EN-82).
Guide Type	Choose from one of the following: Metronome: Plays a metronome tone. Drum: Plays a drum pattern.

Setting item	Setting value and description						
Pattern	If “Guide Type” is “Metronome”: Sets the metronome’s beat.						
	<table border="1"> <tr> <td>Bell Off</td> <td>Plays a click sound on every beat.</td> </tr> <tr> <td>1 Beat</td> <td>Plays a bell sound on every beat.</td> </tr> <tr> <td>2 Beat to 9 Beat</td> <td>Sets the number of beats between 2 and 9. Plays a bell sound on the first beat and a click sound on the remaining beats.</td> </tr> </table>	Bell Off	Plays a click sound on every beat.	1 Beat	Plays a bell sound on every beat.	2 Beat to 9 Beat	Sets the number of beats between 2 and 9. Plays a bell sound on the first beat and a click sound on the remaining beats.
	Bell Off	Plays a click sound on every beat.					
	1 Beat	Plays a bell sound on every beat.					
2 Beat to 9 Beat	Sets the number of beats between 2 and 9. Plays a bell sound on the first beat and a click sound on the remaining beats.						
If the “Guide Type” is “Drum”: You can choose any pattern from the list of drum patterns displayed. For more information, see “ Drum Pattern List ” (page EN-83).							
Volume	Sets the metronome volume relative to the overall volume of the Digital Piano as a number between 0 (silent) and 127 (maximum volume).						
While Playing	Sets whether the metronome will play a sound (On) or not (Off) during playback of MIDI data songs in SONG mode (page EN-106).						
While Recording	Sets whether the metronome will play a sound (On) or not (Off) while recording with the MIDI recorder (page EN-113).						

4. Change the value of the selected setting.

- Trace the touch ring to change the desired setting.

5. Repeat Steps 3 and 4 as necessary.

■ Tempo Markings

Selecting this setting:	Sets this tempo (BPM)
Largo	46
Lento	52
Adagio	56
Andante	72
Moderato	96
Allegretto	108
Allegro	132
Vivace	160
Presto	184

■ Drum Pattern List

Drum Pattern Name	Beat	Description
8 Beat 1	4	Simple 8-beat rhythm
8 Beat 2	4	Simple 8-beat rhythm
8 Beat Shuffle	4	8-beat shuffle rhythm
Triplet8Beat 1	4	Triplet 8-beat rhythm
Triplet8Beat 2	4	Triplet 8-beat rhythm
6/8 Pop	6	6-beat rhythm for slow tempo
16 Beat	4	Simple 16-beat rhythm
16 Beat Shuffle	4	16-beat shuffle rhythm
Ballad 8 Beat	4	8-beat rhythm for slow tempo
Ballad 16 Beat	4	16-beat rhythm for slow tempo
Dance Beat	4	Simple dance beat
Dance Shuffle	4	Dance beat shuffle
Waltz	3	Waltz rhythm
March	2	2-beat march rhythm
Bossa Nova	4	Bossa nova rhythm
Salsa	4	Salsa rhythm with percussion
Swing	4	Swing rhythm for jazz
Slow Swing	4	Swing rhythm for slow jazz
Jazz Waltz	3	Jazz waltz rhythm
5/4 Jazz	5	5-beat jazz rhythm

■ To set the tempo by tapping a beat with the keyboard keys

1. While touching the **FUNCTION** button, touch the **ENTER** button.

The "TAP TEMPO" screen appears.



2. Press a keyboard key two or more times in succession.

- This sets the tempo according to the interval between key presses. The display shows the set tempo value.

Using the Arpeggiator

The Arpeggiator automatically plays arpeggios (broken chords) and various other patterns with a single press of the keys. There are many types to choose from, including patterns that play arpeggios from chords being played and many more.

Enabling or Disabling the Arpeggiator

1. Select the “12 Control” of the F button set. See “[To change the F Button Set](#)” (page [EN-32](#)).

2. Touch the **F1** button (ARPEG).

The Arpeggiator turns on and **AP** appears on the display.

Appears when the Arpeggiator is on



- When a chord or single note is pressed on the keyboard, the Digital Piano plays an arpeggio of the currently selected type.

3. To turn off the Arpeggiator, touch the **F1** button (ARPEG) so **AP** is not displayed.

Changing the Arpeggiator Pattern and Other Settings

1. Select the “12 Control” of the F button set. See “[To change the F Button Set](#)” (page [EN-32](#)).

2. Touch and hold the **F1** button (ARPEG).

The “ARPEGGIATOR” screen appears.

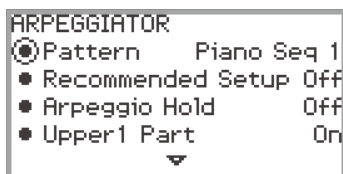

3. Touch the top or bottom of the touch ring to select the setting you want to change.

- The table below shows the setting items, values and descriptions of each.

Setting item	Values	Description
Pattern	*1	Selects the pattern the Arpeggiator will play.
Recommended Setup	On, Off *2	When "On", the Digital Piano automatically applies the recommended tones and settings for the Arpeggiator's pattern whenever you switch the Arpeggiator from Off to On or whenever you switch to "Pattern" while the Arpeggiator is on.
Arpeggio Hold	On, Off *3	Toggles Arpeggio Hold On/Off. When "On", the arpeggio will continue to play even after you lift your finger from the keys.
Upper1 Part Upper2 Part Lower Part	On, Off *3	Selects whether the Arpeggiator will play (On) or not play (Off) in the Upper 1, Upper 2, or Lower Parts.

*1 See "Arpeggiator List" (page EN-233).

*2 Items that are automatically set when this setting is "On" include the following:

- The key range (the Split Point between Upper and Lower Parts) in which the Arpeggiator plays is set automatically. For this reason, depending on the keys pressed, the Arpeggiator may not play.
- Enabling/disabling the use of the pedal for each part (Upper 1/Upper 2/Lower) is set automatically. The applicable pedals are those connected to the **PEDAL UNIT** jack and those connected to the **EXPRESSION/ASSIGNABLE** jack (only when "Damper" is selected as the pedal's function).

*3 Even if these settings are "Off", if "Recommended Setup" is "On", the recommended settings are given priority and applied. For details on recommended settings for each pattern, see "Arpeggiator List" (page EN-233).

4. Change the value of the selected item.

- Trace the touch ring to change the desired value.

5. Repeat Steps 3 and 4 as necessary.

NOTE

- The arpeggio speed depends on the tempo setting. For more information, see "Changing the Metronome Settings (Tempo, Beat, Pattern, etc.)" (page EN-81).
- You can assign turning the Arpeggio Hold on/off to a pedal connected to the **EXPRESSION/ASSIGNABLE** jack. For more information, see "Using Pedals" (page EN-67).
- Assigning "Arpeg Note Len" to the **CONTROL** button allows you to change the length of notes in some Arpeggiator patterns. For more information, see "Selecting the Function Assigned to the CONTROL Button" (page EN-77).
- Assigning "Arpeg Note Len" to either of the **K1** or **K2** knob allows you to change the length of notes in some Arpeggiator patterns. For more information, see "Changing the Function Assigned to a Knob" (page EN-73).

Saving and Recalling Performance Setups (Registration)

The state of various settings such as tone selection, Layers, Splits, and effects can be registered as a performance setup. Registered settings can also be recalled* together simultaneously. This function is called “Registration”.

* By using it with the Freeze function (page EN-90), it is possible to recall only a portion of the registered settings.

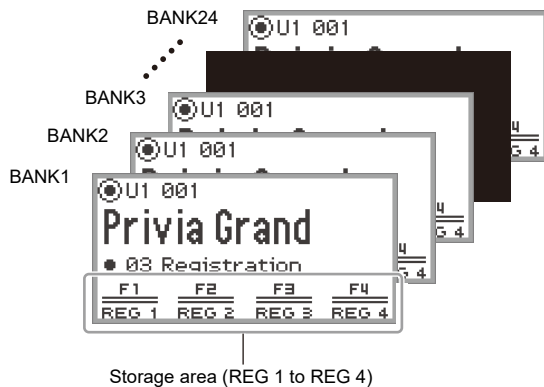

There are four registration areas, REG 1 to REG 4, corresponding to the **F1** (REG 1) to **F4** (REG 4) buttons, respectively. A set of REG 1 to REG 4 is called a “bank”, and there are 24 banks in total, meaning you can register up to 96 setting states.

NOTE

- Registration is not available during demo song playback (page EN-39), SONG mode (page EN-106), or during various setting operations.

Saving a Setup Registration

1. Set as many tones, effects, and other registrable items (page [EN-92](#)) as you need.
2. Select the “02 Regist Setting” of the F Button Set. See “[To change the F Button Set](#)” (page [EN-32](#)).



3. Touch the **F1** button (BANK).

The “REGIST BANK” screen appears.



4. Trace the touch ring to select the destination bank, then touch the **EXIT** button.

5. Touch the **F2** button (STORE).

The “REGIST STORE” screen appears.



- 6. Touch one of the F buttons (F1 to F4) to select the destination (REG 1 to REG 4).**
A confirmation screen appears. To exit the operation without saving, touch the left of the touch ring (NO).



- 7. Touch the right of the touch ring (YES) to save the registration.**
“Complete” appears, and the display returns to the screen shown in Step 5.
- 8. Touch the EXIT button to return to the top screen.**

Changing a Registration Bank Name

- 1. Select the bank you want to rename using Steps 2 through 4 of “Saving a Setup Registration” (page EN-87).**
- 2. Touch the F4 button (BNAME).**
The bank name editing screen appears.



- 3. Change the bank name to the desired name.**
- For details on the subsequent steps, see “Text Character Input” (page EN-35).

Recalling a Setup Registration

1. Select the bank of the setup you want to recall by performing Steps 2 through 4 of [“Saving a Setup Registration”](#) (page EN-87).
 - This procedure is not necessary if you want to recall the registration from the currently selected bank.
2. Turn the Freeze function on or off as needed.
 - For more information, see [“Freeze Function”](#) (page EN-90).
3. Select the “03 Registration” of the F Button Set. See [“To change the F Button Set”](#) (page EN-32).



4. Touch one of the F buttons (F1 to F4).

The corresponding registration (REG 1 to REG 4) is recalled.

The [] indicates that registration was recalled



Freeze Function

By turning on the Freeze function, you can prevent certain setting items from being changed when the registration is recalled. Use the following procedure to select which setting item to freeze.

■ To select freeze items

1. Select “02 Regist Setting” as the F Button Set. See “To change the F Button Set” (page EN-32).
2. Touch and hold the **F3** button (FREEZ).
The “FREEZE” screen appears.

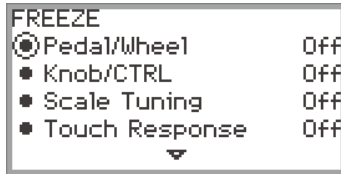

3. Touch the top or bottom of the touch ring to select the setting item you want to change.
 - For details on the setting items, see “Registration Memory Data” (page EN-92).
4. Switch the setting value of the selected item between “On” (freeze) and “Off” (do not freeze).
5. Repeat Steps 3 and 4 as necessary.

■ To enable or disable freeze

1. Select the “02 Regist Setting” of the F Button Set. See “To change the F Button Set” (page EN-32).
2. Touch the **F3** button (FREEZ).
The Freeze function is turned on, and **FZ** appears on the display.

Appears when Freeze is on



3. To turn off the Freeze function, touch the **F3** button (FREEZ) so **FZ** is not displayed.

Using a Pedal to Cycle Through Multiple Setup Registrations (Sequential Recall)

Registrations can be sequentially recalled using a pedal connected to the **EXPRESSION/ASSIGNABLE** jack.

- 1. Connect a pedal to the **EXPRESSION/ASSIGNABLE** jack.**
 - Make sure the pedal type corresponds to the connected pedal (see “[To specify the pedal type](#)” (page [EN-68](#))).
- 2. Refer to “[To select freeze items](#)” (page [EN-90](#)) to switch the “Pedal/Wheel” setting to “On”.**
- 3. Refer to “[To enable or disable freeze](#)” (page [EN-90](#)) to turn on the Freeze function.**
- 4. Refer to “[To specify the pedal function](#)” (page [EN-69](#)) to change the value of “Pedal Target” to “Seq Recall Inc” or “Seq Recall Dec”.**
- 5. Step on the pedal to recall a registration.**
 - When the set value is “Seq Recall Inc”:
Briefly stepping on the pedal recalls registrations in ascending order of “bank number – registration number” (i.e., 1-1, 1-2, 1-3, 1-4, 2-1, 2-2...). Stepping on the pedal and holding it recalls registrations in reverse order (i.e., 2-2, 2-1, 1-4, 1-3...).
 - When the set value is “Seq Recall Dec”:
Briefly stepping on the pedal recalls registrations in descending order of “bank number - registration number” (i.e., 24-4, 24-3, 24-2, 24-1, 23-4, 23-3...). Stepping on the pedal and holding it recalls registrations in reverse order (i.e., 23-3, 23-4, 24-1, 24-2...).

Registration Memory Data

Setting Items	Freeze* ¹
<ul style="list-style-type: none"> Pedal unit, EXPRESSION/ASSIGNABLE pedal, and pitch bend wheel Part On/Off settings EXPRESSION/ASSIGNABLE pedal functions Pitch Bend Range 	Pedal/Wheel
<ul style="list-style-type: none"> CONTROL Button settings Knob settings Portamento On/Off, Rotary Slow/Fast, and Modulation (value, Part On/Off) settings by CONTROL button operations Settings by knob operations*² 	Knob/CTRL
<ul style="list-style-type: none"> Scale settings (type, base note, stretch tuning) 	Scale Tuning
<ul style="list-style-type: none"> Touch Response settings 	Touch Response
<ul style="list-style-type: none"> Hall Simulator/Reverb (On/Off, Type) Surround (On/Off, Type) 	Sound Mode
<ul style="list-style-type: none"> Chorus type Brilliance setting Microphone Effect (Type, Effect On/Off, M1 to M3 settings) Brilliance setting by knob operations 	Effect
<ul style="list-style-type: none"> Transpose setting 	Transpose
<ul style="list-style-type: none"> Split Point setting 	Split Point
<ul style="list-style-type: none"> Arpeggiator (On/Off, Type, and other settings) Arpeggio Hold On/Off setting by a pedal connected to the EXPRESSION/ASSIGNABLE jack Arpeggio Note Length settings by CONTROL button or knob operations 	Arpeggiator
<ul style="list-style-type: none"> Metronome settings (Tempo, Tempo Mark, Guide Type, Pattern) Tempo setting by a pedal connected to the EXPRESSION/ASSIGNABLE jack 	Tempo
<ul style="list-style-type: none"> Tone number (Upper 1, Upper 2, Lower) Layer On/Off, Split On/Off DSP (Type, parameters) Hammer Response, Key Off Response Octave Shift Part Fine Tune Duet settings Tone related settings by knob operations*³ 	Tone
<ul style="list-style-type: none"> Mixer settings Mixer related settings by knob operations*⁴ Layer Balance setting by a pedal connected to the EXPRESSION/ASSIGNABLE jack 	Mixer

- *1 The “Freeze” column shows the names of parameters included in the “FREEZE” screen. For more information, see [“To select freeze items”](#) (page EN-90).
- *2 Corresponds to the functions displayed as “Knob/CTRL” in the “Category” column of [“List of Assignable Functions to the Knobs”](#) (page EN-74).
- *3 Corresponds to the functions displayed as “Tone” in the “Category” column of [“List of Assignable Functions to the Knobs”](#) (page EN-74).
- *4 Corresponds to the functions displayed as “Mixer” in the “Category” column of [“List of Assignable Functions to the Knobs”](#) (page EN-74).

Saving to an External Device

Registration data can be saved to a USB flash drive as banks. For more information, see [“Saving Digital Piano Data to a USB Flash Drive”](#) (page EN-143).

Using the F Button Set

A set of four F buttons, each assigned a function, is called an F Button Set. There are 14 preset F Button Sets that have predefined names and functions and 16 user F Button Sets that the user can freely assign names and functions to.

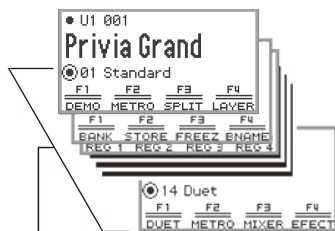

Preset F Button Sets (01–14)

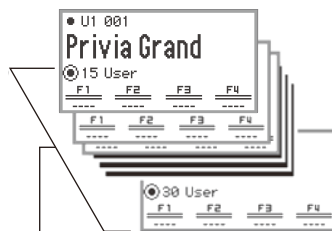

User F Button Sets (15–30)

Assign frequently used tones, functions, etc. to a user F Button Set according to the song you are playing.

Preset F Button Set List

The names of F Button Sets 01 to 14 and the functions assigned to each F button are shown in the table below.

No.	F Button Set Name		F1	F2	F3	F4
01	Standard	(Standard)	DEMO	METRO	SPLIT	LAYER
02	Regist Setting	(Registration Setting)	BANK	STORE	FREEZ	BNAME
03	Registration	(Registration)	REG 1	REG 2	REG 3	REG 4
04	Listening	(Listening)	ADPTR	SMODE	PPOSI	MIXER
05	Song Play	(Song Play)	SONG	SMODE	PPOSI	MICFX
06	Song Lesson	(Song Lesson)	SONG	◀◀	▶▶	METRO
07	Piano Collect	(Piano Collection)	001PR	004ST	005BA	009CO
08	E.PianoCollect	(Electric Piano Collection)	018SP	019JU	023IN	024WH
09	Favorite Piano	(Favorite Piano)	ACSIM	EFFECT	SMODE	PPOSI
10	Effect	(Effect)	SMODE	PPOSI	EFFECT	DSP
11	Vocal	(Vocal)	ADPTR	MICFX	SMODE	MIXER
12	Control	(Control)	ARPEG	TRANS	KNOB	CTRL
13	KB Setting	(Keyboard Setting)	KEYBD	WHEEL	PEDAL	CTRL
14	Duet	(Duet)	DUET	METRO	MIXER	EFFECT

 This function can only be used with an F button (not included in the FUNCTION menu).

 Recalls a dedicated screen.

Editing an F Button Set

Assigning a Function to an F Button (Creating a User F Button Set)

There are two ways to assign desired functions to F buttons, creating a user F Button Set:

- Edit the preset F Button Set (or a user F Button Set that has already been assigned functions) and save it as a user F Button Set (see [Example 1]).
- Assign new functions to an empty user F Button Set and save it (see [Example 2]).

[Example 1]: Editing the “01 Standard” preset F Button Set and saving it as a user F Button Set

1. Select the “01 Standard” of the F Button Set. See “[To change the F Button Set](#)” (page [EN-32](#)).



2. While touching the **FUNCTION** button, touch the **F1** button.

The “F BUTTON EDIT” screen appears.

- Since you touched the **F1** button, the **F1** button is selected as the target for assigning a different function.

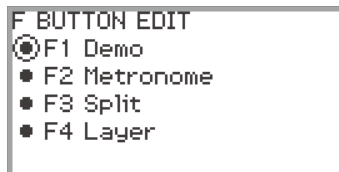

3. Trace the touch ring to change the setting value for the F1 button.

- For details on the displayed settings and the corresponding functions, see “F Button Function List” (page EN-103).
- To assign a tone to an F button, you must change the setting value to “Tone Category” and touch the **ENTER** button to select a tone. For more information, see “Assigning a tone to an F button” (page EN-99).

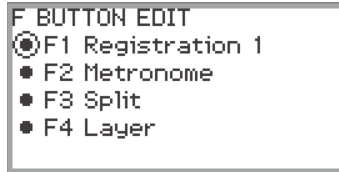

- To change the function assignments of other F buttons, touch the top or bottom of the touch ring while the “F BUTTON EDIT” screen is displayed to select “F2”, “F3”, or “F4”, then change the setting of the selected button.

4. When you are done making the necessary changes, touch the EXIT button.

A screen appears to confirm whether you want to save the F Button Set. To exit the operation without saving, touch the left of the touch ring (NO).



5. Touch the right of the touch ring (YES) to save.

A screen appears to select which user F Button Set to use as the save destination.

- The user F Button Sets that have already been assigned functions and saved are marked with a “*” to the right of their numbers. Selecting a set marked with “*” will overwrite it.



6. Trace the touch ring to select a user F Button Set as the save destination then touch the **ENTER button.**

After “Complete” appears, the display returns to the top screen.



[Example 2]: Assigning new functions to an empty user F Button Set and saving it

1. Select an empty user F Button Set. See [“To change the F Button Set”](#) (page EN-32).
2. Touch the **FUNCTION** button to display the FUNCTION menu.
3. Use the touch ring to select “F BUTTON SETTING” > “F BUTTON EDIT”.

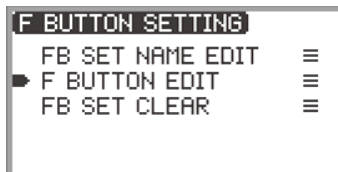

4. Touch the **ENTER button.**

The “F BUTTON EDIT” screen appears.

- The **F1** button is now selected as the target that will be assigned a different function.
- “----” appears to the right of the F buttons that do not have an assigned function.

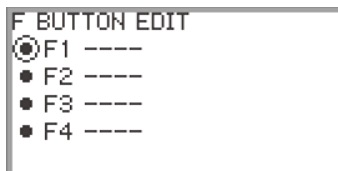

5. Trace the touch ring to change the desired setting.

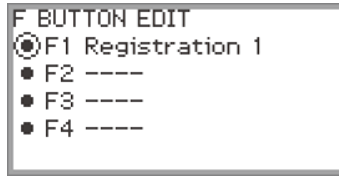

- For more information on the displayed settings and the assignable F button functions corresponding to those settings, see “[F Button Function List](#)” (page [EN-103](#)).
- To assign a tone to the F button, you must change the setting value to “Tone Category” and touch the **ENTER** button to select a tone. For more information, see “[Assigning a tone to an F button](#)” (page [EN-99](#)).

6. Touch the top or bottom of the touch ring while the “F BUTTON EDIT” screen is displayed to select “F2”, “F3”, or “F4”, and then change the setting of the selected button.

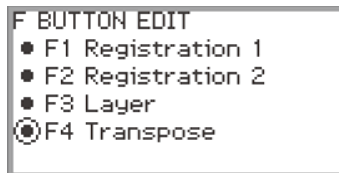

7. When you are done making the necessary changes, touch the **EXIT** button.

A screen appears to confirm whether you want to save the F Button Set. To exit the operation without saving, touch the left of the touch ring (NO).



8. Touch the right of the touch ring (YES) to save.

A screen appears to select which user F Button Set to use as the save destination.

- User F Button Sets that have already been assigned functions and saved are marked with a “*” to the right of their numbers. Selecting a set marked with “*” will overwrite it.



9. Trace the touch ring to select the user F Button Set to use as the save destination then touch the **ENTER** button.

After “Complete” appears, the display returns to the “F BUTTON SETTING” screen.

10. Touch and hold the **EXIT** button to return to the top screen.

■ Assigning a tone to an F button

Perform the following during Step 3 of [Example 1] (page [EN-95](#)) or Step 4 of [Example 2] (page [EN-97](#)).

1. Touch the **ENTER** button to display the list of settings and select “Tone Category”.

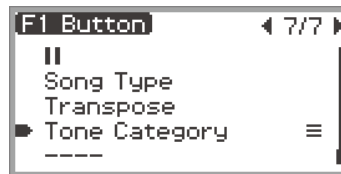

2. Touch the **ENTER** button.

A list of tone categories is displayed.

3. Use the touch ring to select a tone category, then touch the **ENTER** button.

A list of tone names is displayed.

4. Use the touch ring to select a tone.

5. Touch the **EXIT** button three times to return to the “F BUTTON EDIT” screen.

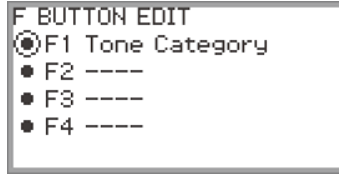

NOTE

- Regardless of the tone selected in Step 4 above, the “F BUTTON EDIT” screen will display “Tone Category” as the setting value. When you return to the top screen after saving the F Button Set, the tone number and the first two letters of the tone name appear in the F button menu, as shown below.

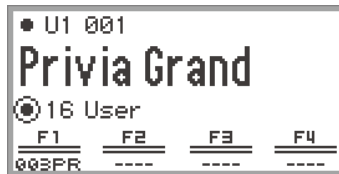

Changing the Name of an F Button Set

- Select the F Button Set you want to rename. See “[To change the F Button Set](#)” (page [EN-32](#)).
- Touch the **FUNCTION** button to display the FUNCTION menu.
- Use the touch ring to select “F BUTTON SETTING” > “FB SET NAME EDIT”.

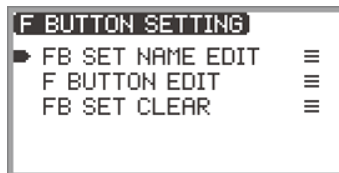

4. Touch the **ENTER** button.

The F Button Set name editing screen appears.



5. Change the F Button Set name to the desired name.

- For more information on operations, see “[To change a character](#)” (page EN-35), “[To insert a character](#)” (page EN-36), and “[To delete a character](#)” (page EN-36).

6. When you are done making your changes, touch the **ENTER** button.

A screen appears to confirm whether you want to save the name of the F Button Set. To return to the editing screen without saving, touch the left of the touch ring (NO).



7. Touch the right of the touch ring (**YES**).

A screen appears to select which user F Button Set to use as the save destination.

8. Trace the touch ring to select the user F Button Set to use as the save destination, then touch the **ENTER** button.

After “Complete” appears, the display returns to the “F BUTTON SETTING” screen.

9. Touch and hold the **EXIT** button to return to the top screen.

Erasing an F Button Set

1. Touch the **FUNCTION** button to display the FUNCTION menu.
2. Use the touch ring to select “F BUTTON SETTING” > “FB SET CLEAR”.

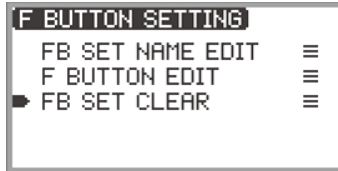

3. Touch the **ENTER** button.
A screen appears to select the F button set to erase.



4. Touch the top or bottom of the touch ring to select the F button set to erase, then touch the **ENTER** button.

A screen appears to confirm whether you want to erase the F Button Set. To cancel, touch the left of the touch ring (NO).

5. Touch the right of the touch ring (**YES**) to erase.
After “Complete” appears, the display returns to the “F BUTTON SETTING” screen.
6. Touch and hold the **EXIT** button to return to the top screen.

F Button Function List

- The “Function Name” column indicates the value displayed on the “F BUTTON EDIT” screen.
- The “F Button Display” column is the text that appears in the F button menu.
- The “Function” column indicates the function to be performed when the F button is touched.
 - ◆ indicates the function to be performed when the F button is pressed and held.

Function Name	F Button Display	Function	Reference
Demo	DEMO	The Digital Piano will wait for the demo song to start.	“Listening to the Demo Songs” (page EN-39)
Metronome	METRO	Displays the metronome setting screen.	“Using the Metronome” (page EN-81)
Split	SPLIT	Turns Split on and off. ◆Displays the Split Point setting screen.	“Splitting the Keyboard Between Two Tones (Split)” (page EN-46)
Layer	LAYER	Turns Layer on and off.	“Sounding Two Different Tones at the Same Time (Layer)” (page EN-44)
Bank	BANK	Displays the Registration Bank selection screen.	“Saving a Setup Registration” (page EN-87)
Bank Name	BNAME	Displays the Registration Bank name edit screen.	“Changing a Registration Bank Name” (page EN-88)
Store	STORE	Displays the “REGIST STORE” screen (for saving a setup registration).	“Saving a Setup Registration” (page EN-87)
Freeze	FREEZ	Turns Freeze function on/off. ◆Displays the Freeze function setting screen.	“Freeze Function” (page EN-90)
Registration 1	REG 1	Recalls registration area numbers 1 through 4.	“Recalling a Setup Registration” (page EN-89)
Registration 2	REG 2		
Registration 3	REG 3		
Registration 4	REG 4		
Adaptor	ADPTR	Turns the Wireless MIDI & Audio Adaptor on and off. ◆Displays the wireless setup screen.	“Enabling and Disabling the Digital Piano’s Wireless Function” (page EN-149)
Sound Mode	SMODE	Displays the Sound Mode selection screen. ◆Displays the Sound Mode setting screen.	“Enabling or Disabling the Hall Simulator/Reverb and Surround Effects” (page EN-49)
Piano Position	PPOSI	Displays the Piano Position setting screen.	“Selecting the Piano Position Setting” (page EN-38)

Function Name	F Button Display	Function	Reference
Effect	EFFECT	Displays the "EFFECT" screen where you can select the Chorus Type and adjust the Brilliance.	"Using Chorus (Chorus, Flanger, Short Delay)" (page EN-57), "Adjusting Brilliance" (page EN-58)
Mic Effect	MICFX	Turns the Microphone Effect on and off. ◆Displays the Microphone Effect setting screen.	"Using Microphone Effects" (page EN-61)
DSP	DSP	Turns DSP on and off. ◆Displays the DSP setting screen.	"Using DSP Effects" (page EN-52)
Acoustic Sim.	ACSIM	Displays the Acoustic Simulator settings screen.	"Adjusting Acoustic Piano Sound Characteristics (Acoustic Simulator)" (page EN-59)
Mixer	MIXER	Displays the Mixer settings screen.	"Using the Mixer" (page EN-65)
Song	SONG	Displays the SONG mode screen for song playback.	"Playing Back MIDI Data or Audio Data" (page EN-107)
Arpeggiator	ARPEG	Turns the Arpeggiator on and off. ◆Displays the Arpeggiator setting screen.	"Using the Arpeggiator" (page EN-84)
Duet	DUET	Turns the Duet function on and off. ◆Displays the Duet function setting screen.	"Splitting the Keyboard for Duet Play" (page EN-135)
Keyboard	KEYBD	Displays the "KEYBOARD" screen in the FUNCTION menu.	"Using the FUNCTION Menu" (page EN-33)
Knob	KNOB	Displays the KNOB setting screen. ◆Resets the parameters of the functions that are currently assigned to the knobs.	"Using the Knobs" (page EN-72)
Control	CTRL	Displays the CONTROL button setting screen.	"Using the CONTROL Button" (page EN-77)
Pedal	PEDAL	Displays the setting screen for the pedal connected to the EXPRESSION/ ASSIGNABLE jack.	"EXPRESSION/ ASSIGNABLE jack" (page EN-68)
Wheel	WHEEL	Displays the pitch bend wheel setting screen.	"Using the Pitch Bend Wheel" (page EN-79)

Function Name	F Button Display	Function	Reference
◀◀	◀◀	Backs up the song a little. ◆Rewinds the song.	"Playing Back MIDI Data or Audio Data" (page EN-107)
▶▶	▶▶	Advances the song a little. ◆Fast-forwards the song.	"Playing Back MIDI Data or Audio Data" (page EN-107)
⏸	⏸	Pauses the currently playing song.	"Playing Back MIDI Data or Audio Data" (page EN-107)
Song Type	STYPE	Displays the song setting screen.	"Playing Back MIDI Data or Audio Data" (page EN-107)
Transpose	TRANS	Displays the Transpose setting screen.	"Changing the Pitch in Semitone Steps (Transpose)" (page EN-130)
Tone Category	*	Recalls the specified tone.	"Assigning a tone to an F button" (page EN-99)
----	----	No function assigned to the F button.	–

* The tone number (3 digits) of the specified tone followed by the first two letters of the tone name are displayed.

Listening to Songs (SONG Mode)

MIDI and audio data can be played back in the SONG mode screen that appears when you touch the  button.

Data Types of Playable Songs

NOTE

- For details on saving MIDI and audio data that can be played back on this Digital Piano to a USB flash drive, see “[Saving MIDI Files or Audio Files for Playback on your Digital Piano to a USB Flash Drive](#)” (page EN-143).

■ MIDI Data

The table below shows the types of MIDI data saved in either the Digital Piano’s internal memory or USB flash drive that can be played back.

Song Number* ¹	Type of Song	File Extension* ²
001 to 010	User songs: Up to 10 of your favorite songs can be stored in the Digital Piano’s internal memory. The data can be transferred to the Digital Piano from a USB flash drive or smart device. For more information, see “ Loading USB Flash Drive Data into the Digital Piano’s Internal Memory ” (page EN-145) and “ Using the Dedicated App ” (page EN-155).	MID, CMF
011 to 015	MIDI recorder songs: Songs recorded by the Digital Piano’s MIDI recorder. For more information, see “ Using the MIDI Recorder to Record Performances ” (page EN-113).	MRF
016 to 999	USB flash drive songs: Standard MIDI files (SMF format 0/1) or CASIO MIDI files (CMF format) stored on a USB flash drive can be played back without having to transfer them to the Digital Piano.	MID, CMF

*¹ The song number is displayed to the left of the song data name in the SONG mode screen. You can identify the type of MIDI song by the song number.

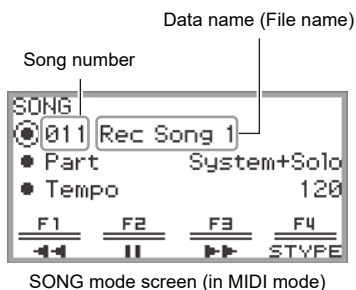

*² The extension is displayed when the file is viewed on a computer or other device. It does not appear in the SONG mode screen.

MID: Standard MIDI file (SMF format 0/1)

CMF: CASIO MIDI file (CASIO’s proprietary extended MIDI format)

MRF: Dedicated format for MIDI recorder songs recorded with this Digital Piano

■ Audio Data

The following audio data stored in a USB flash drive can be played back.

- WAV file (Linear PCM, 16-bit, 44.1kHz, stereo, file name extension: .WAV)
- MP3 file (MPEG-1 Audio Layer3, 44.1kHz/48kHz, 32 to 320kbps variable bit rate (VBR), monaural/stereo, file name extension: .MP3)

Audio recorder songs recorded with this Digital Piano are WAV files (file names “TAKE01.wav” to “TAKE99.wav”).

Playing Back MIDI Data or Audio Data

To play back songs stored on a USB flash drive, plug the USB flash drive into the **USB** Type A port of the Digital Piano in advance.

- When a USB flash drive is inserted, “MOUNTING” will be displayed briefly. It may take a minute or so for the message to disappear.
- For information on handling USB flash drives and plugging/unplugging them from the Digital Piano, see “[Preparing a USB Flash Drive](#)” (page EN-138).

NOTE

- For details on saving MIDI data and audio data to a USB flash drive for playback on this Digital Piano, see “[Saving MIDI Files or Audio Files for Playback on your Digital Piano to a USB Flash Drive](#)” (page EN-143).
- For details on loading MIDI data (user songs) from a USB flash drive to the internal memory of this Digital Piano, see “[Loading USB Flash Drive Data into the Digital Piano’s Internal Memory](#)” (page EN-145).
- The metronome can be used during MIDI data playback. For more information, see “[Changing the Metronome Settings \(Tempo, Beat, Pattern, etc.\)](#)” (page EN-81). In the “METRONOME” screen, set “While Playing” to “On”.

1. Touch the ►/■ button.

The SONG mode screen appears.

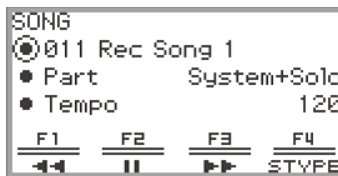

- If a song has been recorded (or played) since the Digital Piano was turned on, the last song recorded (or played) will be played. To stop playback, touch the ►/■ button.

NOTE

- The SONG mode screen can also be displayed by performing the following operations.
 - (1) Select the “05 Song Play” of the F button set. See “[To change the F Button Set](#)” (page EN-32).
 - (2) Touch the **F1** button (SONG).

2. Select “Song Type” according to the song you want to play.

- (1) Touch the **F4** button (STYPE).

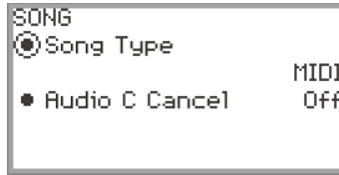

- (2) Trace the touch ring to select the “Song Type” setting from the following:
 “MIDI” ... Play MIDI data from the internal memory or a USB flash drive (MIDI Mode)
 “Audio(USB Drv)” ... Play audio data from a USB flash drive (Audio Mode)
- (3) Touch the **EXIT** button to return to the SONG mode screen.

3. Trace the touch ring to select the song you want to play.

- For MIDI data and audio data for each song, see “Data Types of Playable Songs” (page EN-106).

4. When playing back MIDI data, set the part and tempo to be played back as needed.

- Touch the top or bottom of the touch ring to select the item whose setting you want to change.

Setting item	Setting values and descriptions
Part	For user songs and USB flash drive songs L+R: Plays both parts L: Plays only the left-hand part R: Plays only the right-hand part
	For MIDI recorder songs System + Solo: Plays both tracks System: Plays only the system track Solo: Plays only the solo track
Tempo	Sets the tempo of the song between 20 and 255 (beats/minute)

5. To start playback, touch the ►/■ button.

- During playback, the following operations are available:
 - Touch the **F1** button (◀◀): Backs up the song a little.
 - Touch and hold the **F1** button (◀◀): While held down, the song will rewind.
 - Touch the **F2** button (■): Pauses the currently playing song. Touch while paused to resume playback.
 - Touch the **F3** button (▶▶): Advances the song a little.
 - Touch and hold the **F3** button (▶▶): While held down, the song will fast-forward.
- When the song reaches the end, playback will stop. Touch the ►/■ button to stop midway.

Operations While Playing Back MIDI Data

Sounding Metronome While Playing Back MIDI Data

In the “METRONOME” screen, turn “While Playing” to “On” to have the Metronome sound during MIDI data playback.

For more information, see “[Changing the Metronome Settings \(Tempo, Beat, Pattern, etc.\)](#)” (page EN-81).

Adjusting the Volume Level of MIDI Data Playback (MIXER Settings)

Use “MIXER” > “VOLUME” > “MIDI Song” to adjust the playback volume of MIDI data relative to the overall volume.

For more information, see “[Adjusting the Volume Level, Stereo Pan and Effects for Each Part](#)” (page EN-65).

Deleting a User Song

1. Follow steps 1 through 3 of “[Playing Back MIDI Data or Audio Data](#)” (page EN-107) to select the user song (song numbers 001 to 010) you want to delete.

2. Touch and hold the **●REC** button.

A confirmation screen will appear. To cancel the operation, touch the left of the touch ring (NO) at this point.



3. Touch the right of the touch ring (YES) to delete.

“Complete” is displayed and the display returns to the SONG mode screen.

NOTE

- For details on deleting a MIDI recorder song, see “[Deleting a MIDI Recorder Song \(Entire Song/ Individual Tracks\)](#)” (page EN-119).

Operations While Playing Back Audio Data

Audio Center Cancel (Vocal Cut)

Audio Center Cancel cuts (eliminates or reduces) vocals in the playback audio. Since this function cancels the center-localized sound, sounds other than vocals may also be cut. The degree of the effect depends on the audio data being played.

■ Enabling or Disabling Audio Center Cancel

1. Touch the **▶/■** button to display the SONG mode screen.
2. Touch the **F4** button (STYPE).
3. Touch the top or bottom of the touch ring to select “Audio C Cancel”.

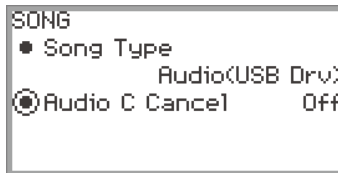

4. Trace the touch ring to toggle the setting between “On” and “Off”.
5. Touch the **EXIT** button to return to the SONG mode screen.

Adjusting the Volume Level or Effect Depth of Audio Data Playback (MIXER Settings)

See “[Adjusting the Volume Level, Stereo Pan and Effects for Each Part](#)” (page EN-65).

- Use “MIXER” > “VOLUME” > “Audio Song” to adjust the playback volume of audio data relative to the overall volume.
- Use “MIXER” > “HALL/REV.” > “AudioSongSend” to adjust the send value of audio data to the Hall Simulator/Reverb by changing the value of the “HALL/REV.” > “AudioSongSend” setting.

Recording Performances

Your Digital Piano can record what you play on the keyboard and play it back when you want. The Digital Piano has two recording functions: a MIDI Recorder and an Audio Recorder. Select the function that suits the needs for the type of recording you want to make.

IMPORTANT!

- CASIO COMPUTER CO., LTD. takes no responsibility for any damages, lost profits, or claims by third parties arising from the deletion of recorded data due to malfunction, repair, or for any other reason.
- Should power fail during recording, all of the data in the song you are recording will be deleted.

MIDI Recorder and Audio Recorder Features

Recording Features

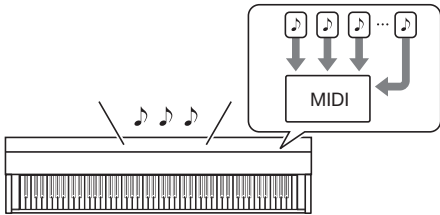
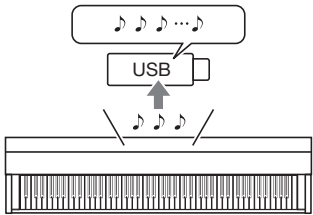
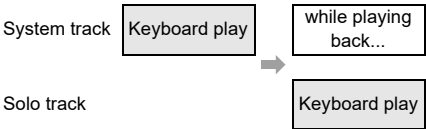
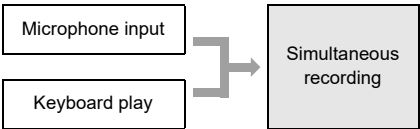
MIDI Recorder	Audio Recorder
<p>Keyboard performance information is recorded to the <u>Digital Piano's internal memory as MIDI data</u>*1 to two tracks (storage areas for keyboard performance data).</p>  <ul style="list-style-type: none"> • Keyboard performance information (keyboard keys press/ release, key velocity, etc.) is recorded as MIDI data. • The size of MIDI data is much smaller when compared with audio data, making it easier to edit later on a computer, etc. • Supported recording capacity: Up to five songs, each song up to approximately 30,000 notes (total of system track and solo track) 	<p>Keyboard performance information is recorded to a <u>USB flash drive as audio data</u>*2.</p>  <ul style="list-style-type: none"> • Like a portable music player or tape recorder, notes are recorded as audio data. • Audio data files are much larger compared to MIDI data files. The advantage of audio data files is that they can be easily played back on a computer, portable music player, etc. • Supported recording capacity: Up to 99 files, each song up to a maximum length of approximately 25 minutes
<p><u>What you can do...</u></p> <p>⇒ Record to one track while playing back from the other track</p> 	<p><u>What you can do...</u></p> <p>⇒ Connect a microphone to record vocals and the keyboard at the same time</p> 

■ Playback Features

MIDI Recorder	Audio Recorder						
<p>Plays back system track and solo track (simultaneously or individually).</p> <ul style="list-style-type: none"> With the MIDI Recorder, the Digital Piano automatically performs playback using its internal sound source in accordance with the performance information recorded as MIDI data. <div style="border: 1px solid black; padding: 5px; margin-top: 10px;"> <p><u>What you can do...</u></p> <p>⇒ Play on the keyboard along with playback of system track and solo track</p> <table style="width: 100%; border-collapse: collapse;"> <tr> <td style="width: 20%;">System track</td> <td style="border: 1px solid black; padding: 2px;">While playing back...</td> </tr> <tr> <td>Solo track</td> <td style="border: 1px solid black; padding: 2px;">While playing back...</td> </tr> <tr> <td></td> <td style="border: 1px solid black; padding: 2px; text-align: center;">Keyboard play</td> </tr> </table> <p>⇒ After recording, change the tempo For example, you can record at a slow tempo and then play back at a faster tempo.</p> </div>	System track	While playing back...	Solo track	While playing back...		Keyboard play	<p>You can play back audio data from a USB flash drive.</p> <ul style="list-style-type: none"> The Audio Recorder plays back the waveform of sound recorded as audio data. <div style="border: 1px solid black; padding: 5px; margin-top: 10px;"> <p><u>What you can do...</u></p> <p>⇒ Play along on the keyboard while the audio data is playing</p> <div style="display: flex; align-items: center; justify-content: center; margin-top: 10px;"> <div style="border: 1px solid black; padding: 5px; margin-right: 10px;">Playback of audio data</div> <div style="font-size: 2em; margin-right: 10px;">+</div> <div style="border: 1px solid black; padding: 5px; margin-left: 10px;">Keyboard play</div> </div> </div>
System track	While playing back...						
Solo track	While playing back...						
	Keyboard play						

*1 MIDI

MIDI is short for “Musical Instrument Digital Interface”. It is a universal standard that makes it possible for musical instruments, computers, and other devices to exchange performance information (keyboard key press/release, key velocity, etc.) regardless of manufacturer. Performance data in this case is called “MIDI data”.

*2 Audio data

Audio data recorded with this Digital Piano is saved in WAV file format (linear PCM, 16bit, 44.1kHz, stereo).



- For details about the file formats of data supported by this Digital Piano, see “[Data Types Supported by the Digital Piano](#)” (page EN-139).
- Data recorded on the Digital Piano can be saved to a USB flash drive. For more information, see “[Saving Digital Piano Data to a USB Flash Drive](#)” (page EN-143).

Using the MIDI Recorder to Record Performances

The MIDI recorder records keyboard performances and pedal operations as MIDI data.

Recording with the MIDI Recorder

1. Put the Digital Piano into MIDI Mode.

- Under the initial default settings, the Digital Piano is in MIDI Mode. In this case, proceed to step 2.
- (1) Touch the **FUNCTION** button to display the FUNCTION menu.
- (2) Use the touch ring to select “SONG” and touch the **ENTER** button.

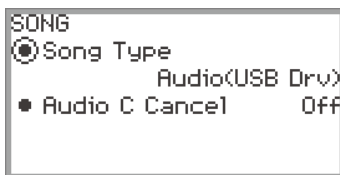

- (3) Trace the touch ring to set the “Song Type” to “MIDI” (MIDI Mode).
- (4) Touch and hold the **EXIT** button to exit the setup screen.

2. If necessary, set tones, effects, tempo, etc. for recording.

- See “[Changing the Metronome Settings \(Tempo, Beat, Pattern, etc.\)](#)” (page EN-81) for beat and tempo settings, and whether the metronome should sound during recording. To have the Metronome sound while recording, set “While Recording” to “On” in the “METRONOME” screen.
- A MIDI recorder song has two recording tracks (a system track and a solo track), and some settings (such as effects) are recorded only on the system track. For what’s recorded on each track, see “[Items Reflected in Contents When Recording to the MIDI Recorder Song](#)” (page EN-120).

3. If necessary, select the song number to record to before recording.

- This operation may be omitted.
- If you select a song number that has already been recorded, the previous recording will be overwritten. Only when you want to intentionally overwrite or select a specific song number, perform the following operation.
- (1) Touch the **▶/■** button to display the SONG mode screen.



(2) Trace the touch ring to select one of the song numbers 011 to 015.

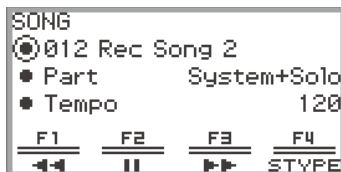

- See “NOTE” on page [EN-115](#) for the song number of the MIDI recorder song.

4. Touch the **●REC** button.

The **●REC** button flashes red and the Digital Piano is ready to record.



- Touching the **●REC** button again here exits record standby.
- Touch and hold the **●REC** button to select the recording track and pre-count settings. For more information, see “MIDI Recorder Recording Settings” (page [EN-116](#)).

5. To start recording, touch the **▶/■** button.

When recording starts, the **●REC** button lights up red.

- Recording can also be started automatically by pressing a keyboard key and starting to play. Recording can also be started with any of the following operations:
 - Pressing down on the pedal
 - Recalling a registration (page [EN-89](#))
 - Pressing the **CONTROL** button
 - Rotating either of the knob
 - Moving the pitch bend wheel up or down
- When the remaining available capacity is low during recording, the **●REC** button will flash. When no more capacity is available, the **●REC** button light will turn off and recording will stop.
- If you want to redo the recording due to a mistake while playing, touch and hold the **●REC** button during recording. The recorded data will be discarded, and the Digital Piano will return to recording standby.

6. To end recording, touch the ●REC button.

The ●REC button will show a white light once again and the SONG mode screen will appear.



- If you want to immediately play back the recorded MIDI recorder song, touch the ►/■ button.
- For more information on playback operations, see “[Playing Back MIDI Recorder Songs](#)” (page EN-118).

NOTE

- MIDI recorder songs are stored in song numbers 011 to 015, “011 Rec Song 1” to “015 Rec Song 5” in the internal memory. Up to five songs can be recorded. Each time you record, the lowest song number that has not yet been recorded is automatically selected. However, please note the following:
 - When the SONG mode screen is displayed in step 3 or step 6, and a song number between 011 and 015 is selected, touching the ●REC button to start recording will overwrite the selected song number.
 - If all five songs have been recorded and step 3 is omitted, when the ●REC button is touched in step 4, “Data Full” will be displayed and recording will not begin. See “[Deleting a MIDI Recorder Song \(Entire Song/Individual Tracks\)](#)” (page EN-119) to erase songs so that you can record again.
- The **FUNCTION** button is inoperative during recording. In addition, the function names of the functions in the F Button Menu that cannot be used are displayed as “----”.

■ MIDI Recorder Recording Settings

A MIDI recorder song has two recording tracks (system track and solo track), and you can choose which track to record to. A precount can also be set to indicate when recording will begin.

1. Perform the operation described in steps 1 through 4 of “Recording with the MIDI Recorder” (page EN-113).

The **●REC** button flashes red and the Digital Piano is ready to record.

2. Touch and hold the **●REC** button.

The “RECORD SETTING” screen appears (record standby is maintained).

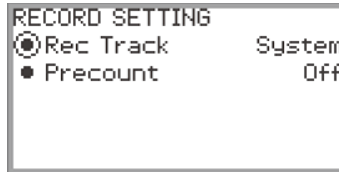

3. Touch the top or bottom of the touch ring to select the setting you want to change.

- The table below shows the setting values and settings for each setting item.

Setting item	Setting values and descriptions
Rec Track	System: Records to the system track. Solo: Records to the solo track. For the recording content of each track see “Items Reflected in Contents When Recording to the MIDI Recorder Song” (page EN-120).
Precount	Sets the pre-count before recording begins Off: Pre-count is not sounded 1 Measure: One-bar measure pre-count 2 Measures: Two-bar measure pre-count

4. Change the setting of the selected item.

- Trace the touch ring to change the desired setting.

5. Repeat steps 3 and 4 as necessary.

6. To start recording with the changed settings, resume operation from step 5 of “Recording with the MIDI Recorder” (page EN-113).

- To stop recording at this point, touch the **●REC** button. The **●REC** button will light up white again.

Recording a Second Track Over the First (System Track + Solo Track)

You can record to one track while playing back a pre-recorded track of a MIDI recorder song.

NOTE

- If you make a mistake while overdub recording, you can erase and re-record the overdubbed track. For more information, see “[Deleting a MIDI Recorder Song \(Entire Song/Individual Tracks\)](#)” (page [EN-119](#)).

1. See “[Playing Back MIDI Recorder Songs](#)” (page [EN-118](#)) to select a pre-recorded MIDI recorder song.
 - Play the selected song to check the recording and the tracks that have already been recorded.
2. Touch the **●REC** button.
The **●REC** button flashes red and the Digital Piano is ready to record.
3. Touch and hold the **●REC** button to display the “RECORD SETTING” screen.
4. Trace the touch ring to set the “Rec Track” to “System” or “Solo”.
 - Select “Solo” to record the solo track while playing the pre-recorded system track, or “System” to record the system track while playing the pre-recorded solo track.

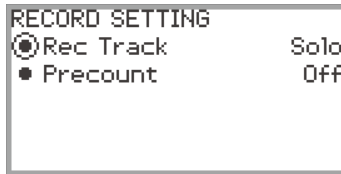

5. Start and stop recording as shown in step 5 and after in “[Recording with the MIDI Recorder](#)” (page [EN-113](#)).

Playing Back MIDI Recorder Songs

1. Touch the ►/■ button.

The SONG mode screen appears.

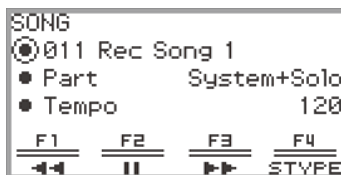

- If any songs have been recorded (or played) since the Digital Piano was turned on, the last song recorded (or played) will be played. To stop playback, touch the ►/■ button.
- From the SONG mode screen, you can play MIDI recorder songs as well as MIDI and audio data in various formats. For more information, see “[Listening to Songs \(SONG Mode\)](#)” (page EN-106).

2. If in Audio Mode, change to MIDI Mode.

- If “Part” and “Tempo” are not displayed in the SONG mode screen, the Digital Piano is in Audio Mode. Perform the following operation to change it to MIDI Mode.
 - (1) Touch the **F4** button (STYPE).
 - (2) Trace the touch ring to change the “Song Type” setting to “MIDI”.
 - (3) Touch the **EXIT** button to return to the SONG mode screen.

3. Trace the touch ring to select the MIDI recorder song you want to play.

The five MIDI recorder songs are named “011 Rec Song 1” to “015 Rec Song 5”. Select the number of a song that has already been recorded.

4. If necessary, set the part and tempo to be played.

Touch the top or bottom of the touch ring to select the setting you want to change.

Setting item	Setting values and descriptions
Part	System + Solo: Plays both tracks System: Plays only the system track Solo: Plays only the solo track
Tempo	Sets the playback tempo from 20 to 255 (beats/minute).

5. To start playback, touch the ►/■ button.

- During playback, the following operations are available.
 - Touch the **F1** button (◀◀): Backs up the song a little.
 - Touch and hold the **F1** button (◀◀): While held down, the song will rewind.
 - Touch the **F2** button (||): Pauses the currently playing song. Touch while paused to resume playback.
 - Touch the **F3** button (▶▶): Advances the song a little.
 - Touch and hold the **F3** button (▶▶): While held down, the song will fast-forward.
- When the song reaches the end, playback will stop. Touch the ►/■ button to stop midway.

Deleting a MIDI Recorder Song (Entire Song/Individual Tracks)

1. “**Playing Back MIDI Recorder Songs**” (page EN-118) operation to select the MIDI recorder song you want to erase.
2. Touch and hold the **●REC** button.
The “CLEAR” screen appears.

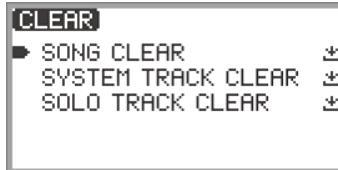

3. Touch the top or bottom of the touch ring to select the target (the entire song or a track) you want to erase.

Menu item	What will be erased
SONG CLEAR	Erases the entire song
SYSTEM TRACK CLEAR	Erases the system track only
SOLO TRACK CLEAR	Erases the solo track only

4. Touch the **ENTER** button.

A confirmation screen will appear. To cancel the operation, touch the left of the touch ring (NO) here.



5. To erase, touch the right of the touch ring (YES).
“Complete” is displayed and the display returns to the SONG mode screen.

Items Reflected in Contents When Recording to the MIDI Recorder Song

The symbols below are used in the “System” column to indicate items that can be recorded to the system track, and in the “Solo” column to indicate items that can be recorded to the solo track.

✓... Recorded — ... Not recorded

Operation or Setting	System	Solo
Keyboard operations	✓	✓
Pedal operations*1	✓*2	✓*2
Pitch Bend Wheel operations	✓	✓
Pitch bend range	✓	✓
The parameter settings with the knob operations (Portamento Time setting, etc.)	✓*3	✓*3 *4
CONTROL button operations	✓	✓
Acoustic Simulator settings	✓	—
Chorus type	✓	—
Brilliance setting	✓	—
Hall Simulator/Reverb settings		
On/Off	✓	—
Type	✓	—
Surround settings	✓	—
Portamento On/Off	✓	✓*5
Tone number	✓	✓*5
Layer, Split	✓	—
Mixer		
Volume		
Keyboard overall volume	✓	—
Upper1, Upper2, Lower part volume	✓	✓*5
Pan		
Upper1, Upper2, Lower part pan	✓	✓*5
Hall Simulator/Reverb		
Overall reverb depth (reverb return)	✓	—
Upper1, Upper2, Lower part send	✓	✓*5
Chorus		
Upper1, Upper2, Lower part send	✓	✓*5
Octave Shift	✓*6	✓*5 *6

Operation or Setting	System	Solo
Part Fine Tune	✓	✓*5
Scale settings	✓	—
Duet settings	✓	—
Metronome		
Tempo	✓	—
Beat	✓	—

*1 Operation of pedals connected to this Digital Piano

*2 Not recorded depending on the function assigned to the pedal that is connected to the **EXPRESSION/ASSIGNABLE** jack.

*3 Not recorded when one of the functions below is assigned to the knob.

“MIDISongVolume”, “WirelessAudioVol”, “AudioSongVolume”

*4 Not recorded when one of the functions below is assigned to the knob.

“Brilliance”, “Layer Balance”, “Upper2 Fine Tune”, “Upper2 Pan”, “Lower Volume”, “Lower Pan”, “KB Group Volume”

When one of the functions below is assigned to the knob, only the setting changes to the Upper 1 part are recorded.

“KB Reverb Send”, “KB Chorus Send”, “UpperPanBalance”

*5 Upper 1 only

*6 Octave-shifted notes are recorded.

Recording a Performance with the Audio Recorder

The audio recorder records the sound output from the Digital Piano as audio data, as shown below.

- Keyboard playing
- Audio input from microphone, etc.

Recording Using the Audio Recorder

1. Put the Digital Piano into Audio Mode.

- (1) Touch the **FUNCTION** button to display the FUNCTION menu.
- (2) Use the touch ring to select “SONG” then touch the **ENTER** button.

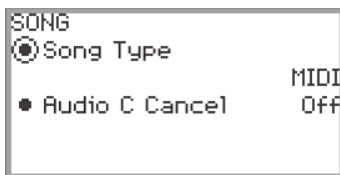

- (3) Trace the touch ring to set the “Song Type” to “Audio(USB Drv)” (Audio Mode).
- (4) Touch and hold the **EXIT** button to exit the setup.

2. Plug a **USB** flash drive into the **USB Type A** port on this Digital Piano.

- When a USB flash drive is plugged in, “MOUNTING” will be displayed for a while. It may take a minute or so for the display to disappear.
- For information on handling USB flash drives and installing and removing them from the Digital Piano, see “[Connecting a USB Flash Drive to and Detaching It from the Digital Piano](#)” (page EN-141).

3. Touch the **REC** button.

The **REC** button flashes red and the Digital Piano is ready to record.

- Touching the **REC** button again here cancels record standby.



4. To start recording, touch the ►/■ button.

When recording starts, the ●REC button lights up red.

- Recording can also be started automatically by pressing a keyboard key and starting to play. Recording can also be started with any of the following operations:
 - Pressing down on a foot pedal
 - Recalling a registration (page EN-89)
 - Pressing the **CONTROL** button
 - Rotating either of the knob
 - Moving the pitch bend wheel up or down
- When the remaining available capacity is low during recording, the ●REC button will flash. When no more capacity is available, the ●REC button light will turn off and recording will stop.
- If you want to redo the recording due to a mistake while playing, touch and hold the ●REC button during recording. The recorded data will be discarded, and the Digital Piano will return to recording standby.

5. To stop recording, touch the ●REC button.

The ●REC button will show a white light once again and the SONG mode screen will appear.

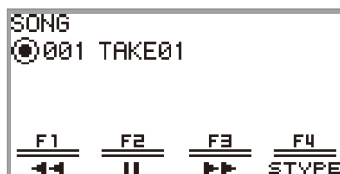

- If you want to play the recorded audio recorder song immediately, touch the ►/■ button.
- For more information on playback operations, see “Playing Back a Song from the Audio Recorder” (page EN-125).

NOTE

- Audio recorder songs are saved with the file name “TAKE**.wav” (where ** is 01 to 99). Up to 99 songs can be recorded to the USB flash drive. Each time a recording is made, a file is automatically created with the next number in sequence in the destination memory (internal or USB). For information on what to do if you get a “Too Many Files” message and cannot start recording, see “Error Messages” (page EN-168).
- The **FUNCTION** button is inoperative during recording. In addition, the function names of the functions in the F Button Menu that cannot be used are displayed as “----”.
- The Digital Piano’s audio recorder records in WAV format. Recording in MP3 format is not supported.
- The table below lists the audio data that can be recorded and played back on the Digital Piano.

WAV format (Record and playback)	<ul style="list-style-type: none"> • The maximum recorded length of a file is approximately 25 minutes, and up to 99 files can be recorded (however, this depends on the available capacity of the USB flash drive used). • There is no limit to the playback time of a single file (depends on the available capacity of the USB flash drive).
MP3 format (Playback only)	There is no limit to the playback time of a single file (depends on the available capacity of the USB flash drive).

- The formats of audio data that can be played on this Digital Piano are shown below. (For playback operations, see “[Playing Back a Song from the Audio Recorder](#)” (page EN-125).)

WAV format audio data

File name extension	.WAV
Format	Linear PCM
Sampling frequency	44.1kHz
Bit depth	16bit
Channel	Stereo

MP3 format audio data

File name extension	.MP3
Format	MPEG-1 Audio Layer3
Sampling frequency	44.1kHz/48kHz
Bit rate	32 to 320kbps variable bit rate (VBR)
Channel	Monaural/Stereo

Playing Back a Song from the Audio Recorder

1. Touch the ►/■ button.

The SONG mode screen appears.



- If any songs have been recorded (or played) since the Digital Piano was turned on, the last song recorded (or played) will be played. To stop playback, touch the ►/■ button.
- The SONG mode screen allows playback of MIDI data and audio data in various formats as well as audio recorder songs. For more information, see “[Listening to Songs \(SONG Mode\)](#)” (page EN-106).

2. If the Digital Piano is in MIDI Mode, change to Audio Mode.

- When “Part” or “Tempo” is displayed on the SONG mode screen, the Digital Piano is in MIDI Mode. Use the following operation to change to Audio Mode.
 - (1) Touch the **F4** (STYPE) button.
 - (2) Trace the touch ring to change the “Song Type” setting to “Audio(USB Drv)”.
 - (3) Touch the **EXIT** button to return to the SONG mode screen.

3. Trace the touch ring to select the audio recorder song you want to play.

4. To start playback, touch the ►/■ button.

- During playback, the following operations are available.
 - Touch the **F1** button (◀◀): Backs up the song a little.
 - Touch and hold the **F1** button (◀◀): While held down, the song will rewind.
 - Touch the **F2** button (||): Pauses the currently playing song. Touch while paused to resume playback.
 - Touch the **F3** button (▶▶): Advances the song a little.
 - Touch and hold the **F3** button (▶▶): While held down, the song will fast-forward.
- When the song reaches the end, playback will stop. Touch the ►/■ button to stop midway.

Deleting a Song from the Audio Recorder

1. See “[Playing Back a Song from the Audio Recorder](#)” (page [EN-125](#)) to select the audio recorder song you want to erase.

2. Touch and hold the **●REC** button.

A confirmation screen will appear. To cancel the operation, touch the left of the touch ring (NO) at this point.



3. To erase, touch the right of the touch ring (YES).

“Wait...” is displayed during the erase process. When done, “Complete” is displayed and the display returns to the SONG mode screen.

Adjusting Keyboard Sensitivity

Changing Keyboard Response to Key Velocity (Touch Response)

Touch Response alters tone volume in accordance with keyboard velocity (speed). This provides you some of the same expressivity you get on an acoustic piano.



Pressing fast produces louder notes.

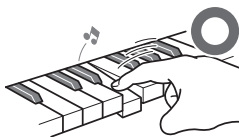

Pressing slowly produces softer notes.



Do not try to use too much pressure.

Changing Touch Response Sensitivity

1. Touch the **FUNCTION** button to display the **FUNCTION** menu.
2. Use the touch ring to select “**KEYBOARD**” > “**KBD SETTING**” then touch the **ENTER** button.

The “KBD SETTING” screen appears.

- Confirm that the cursor (○) is on “Touch Response”.

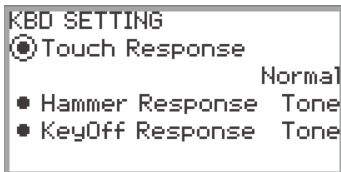

3. Change the value of the “Touch Response” setting.

Setting value	Description
Off	Disables Touch Response. Sound volume is fixed, regardless of key press speed.
Light 2 Light 1	Makes production of a louder sound easier, so touch feels lighter than “Normal”. “Light 2” is lighter to the touch than “Light 1”.
Normal	Specifies normal sensitivity.
Heavy 1 Heavy 2	Makes production of a louder sound more difficult, so touch Heavy feels heavier than “Normal”. “Heavy 2” is heavier to the touch than “Heavy 1”.

- Trace the touch ring to change the desired setting value.

Adjusting the Timing of Key Press to Sound (Hammer Response)

An acoustic piano has hammers of different sizes that strike the strings in different key ranges, so the timing of the sound is different for each key range. “Hammer Response” in the FUNCTION menu can be used to select the timing of the sound.

Adjusting the Hammer Response

1. Touch the **FUNCTION** button to display the FUNCTION menu.
2. Use the touch ring to select “KEYBOARD” > “KBD SETTING” > “Hammer Response”.

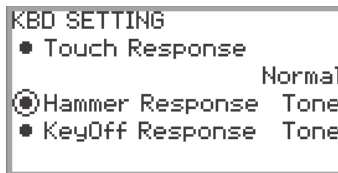

3. Change the “Hammer Response” setting.

Setting value	Description
Tone	A value appropriate for the selected tone is automatically set.
Off	Fastest response in all key ranges.
1 to 10	The higher the value, the slower the timing of the sound.

- Use the touch ring to change the desired value.

Adjusting the Timing of Key Release to Sound Damping (Key-off Response)

On a grand piano, when a key is released, the damper comes down on the strings and the note is damped. The Digital Piano's Key-off Response function simulates digitally the timing of the note damping based on how the key is released.

Using this function, you can set it to allow subsequent key strikes to sound even if the key is not fully released during a series of same-note hits – just like a grand piano. This makes possible detailed touch expressions such as whether notes are connected or cut off, allowing for a natural playing feel.

The “KeyOff Response” in the FUNCTION menu can be used to adjust the timing of the damping.

Adjusting the Key-off Response

1. Touch the **FUNCTION** button to display the FUNCTION menu.
2. Use the touch ring to select “KEYBOARD” > “KBD SETTING” > “KeyOff Response”.

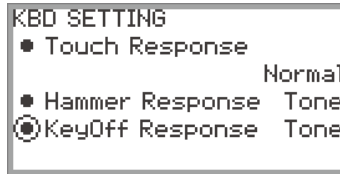

3. Change the “KeyOff Response” setting.

Setting value	Description
Tone	A value appropriate for the selected tone is automatically set.
1 to 3	The higher the value, the slower the timing of the sound.

- Use the touch ring to change the desired setting value.

Changing the Pitch

Changing the Pitch in Semitone Steps (Transpose)

Use the transpose feature to raise or lower the pitch of all notes in semitone steps. This allows you to transpose the key of your playing to another key.

Changing the Transpose Setting

1. Select the “12 Control” of the F Button Set. See “[To change the F Button Set](#)” (page [EN-32](#)).
2. Touch the **F2** button (TRANS).
The “TRANPOSE” screen appears.

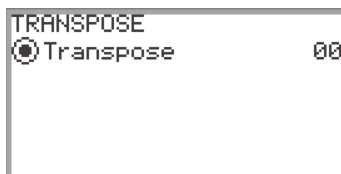

3. Trace the touch ring to change the setting value.
 - It can be changed to a value between -12 and +12 semitones.

Fine Tuning a Pitch (Master Tuning)

Use the tuning feature when you need to adjust the overall pitch of the Digital Piano.

- The tuning feature specifies the frequency of the A4 note. You can set a frequency within the range of 415.5 to 465.9 Hz. The initial default setting is 440.0 Hz.
- You can change the frequency in 0.1 Hz steps.

1. Touch the **FUNCTION** button to display the **FUNCTION** Menu.
2. Touch the top or bottom of the touch ring to select “**SYSTEM**”, then touch the **ENTER** button.

The “SYSTEM” screen appears.

- Confirm that the cursor (○) is on “Master Tuning”.

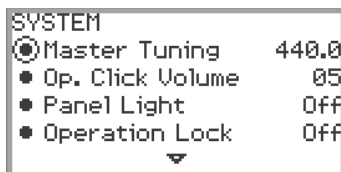

3. Change the value of the “**Master Tuning**” setting.
 - Trace the touch ring to change the desired setting value.

Adjusting the Tuning Separately for Each Part (Upper 1/Upper 2/Lower) (Part Fine Tune)

Each part can be individually fine-tuned between -99 and +99 cents (100 cents = 1 semitone) relative to the tuning of the entire instrument. By shifting the tuning of each part slightly, you can create a full-bodied ensemble feel.

NOTE

- For details on parts, see “[Sounding Two Different Tones at the Same Time \(Layer\)](#)” (page EN-44) and “[Splitting the Keyboard Between Two Tones \(Split\)](#)” (page EN-46).

1. Touch the **FUNCTION** button to display the **FUNCTION** Menu.
2. Use the touch ring to select “**KEYBOARD**” > “**PART FINE TUNE**”, then touch the **ENTER** button.

The “PART FINE TUNE” screen appears.

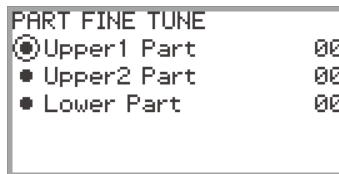

3. Touch the top or bottom of the touch ring to select the part you want to fine-tune.
4. Change the setting value of the selected part.
 - Trace the touch ring to change the desired setting value.
5. Repeat Steps 3 and 4 as necessary.

Changing the Pitch in Octave Units (Octave Shift)

Use the Octave Shift feature to raise or lower the pitch of all notes in octave units. Each part (Upper 1, Upper 2, Lower) can be set individually when using the Layer or Split functions.

NOTE

- For details on parts, see “[Sounding Two Different Tones at the Same Time \(Layer\)](#)” (page EN-44) and “[Splitting the Keyboard Between Two Tones \(Split\)](#)” (page EN-46).

Using Octave Shift Separately for Each Part (Upper 1/Upper 2/Lower)

1. Touch the **FUNCTION** button to display the FUNCTION Menu.
2. Use the touch ring to select “**KEYBOARD**” > “**PART OCT SHIFT**”, then touch the **ENTER** button.

The “PART OCT SHIFT” screen appears.

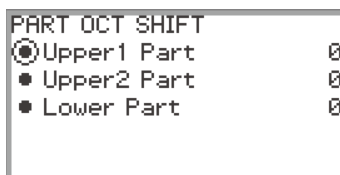

3. Touch the top or bottom of the touch ring to select the part to octave shift.
4. Change the setting value of the selected part.
 - Trace the touch ring to change the desired setting value.
5. Repeat Steps 3 and 4 as necessary.

Changing the Scale Tuning (Temperament) of the Keyboard

You can change the scale of the keyboard from the standard equal temperament to another tuning that is more suitable for playing Indian music, Arabic music, classical music, etc. You can select from among the 17 preset scales described below.

Changing the Scale

1. Touch the **FUNCTION** button to display the **FUNCTION** Menu.
2. Use the touch ring to select “**KEYBOARD**” > “**SCALE TUNING**”, then touch the **ENTER** button.

The “**SCALE TUNING**” screen appears.

- Confirm that the cursor (○) is on “Scale Type”.

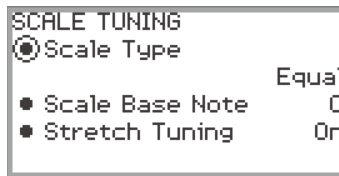

3. Change the “**Scale Type**” setting value.

- Trace the touch ring to change the desired setting value.
- You can choose from the temperaments in the table below.

Setting Value	Scale (Temperament) Name
Equal	Equal Temperament
Pure Major	Pure Major Temperament
Pure Minor	Pure Minor Temperament
Pythagorean	Pythagorean Temperament
Kirnberger 3	Kirnberger 3 Temperament
Werckmeister	Werckmeister Temperament
Mean-Tone	Mean-Tone Temperament
Rast	Rast
Bayati	Bayati
Hijaz	Hijaz
Saba	Saba
Dashti	Dashti
Chahargah	Chahargah
Segah	Segah
Gurjari Todi	Gurjari Todi
Chandrakauns	Chandrakauns
Charukeshi	Charukeshi

4. If necessary, change the base note of the scale.

- (1) In the “SCALE TUNING” screen, touch the top or bottom of the touch ring to select the “Scale Base Note”.
- (2) Trace the touch ring to change the desired base note.

Enabling or Disabling Piano Stretch Tuning

Generally, a piano is tuned so high notes are relatively higher and low notes are relatively lower. This type of tuning is called “stretch tuning”. You can disable Stretch Tuning, if you want.

1. Touch the **FUNCTION** button to display the **FUNCTION** Menu.
2. Use the touch ring to select “KEYBOARD” > “SCALE TUNING” > “Stretch Tuning”.

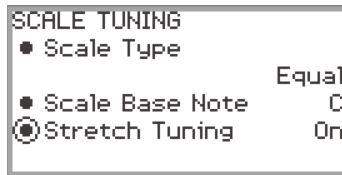

3. Trace the touch ring to toggle the setting value between “On” and “Off”.

Splitting the Keyboard for Duet Play

You can split the keyboard in the center for duet play so the left and right sides have the same ranges. The Duet function is the perfect way to conduct lessons, with the teacher playing on the left side as the student plays the same song on the right side. You can also change the ranges of the left and right keyboards in octave units from their initial default settings.

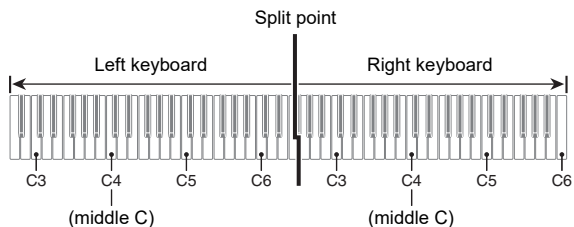

Using the Duet

1. Select the "14 Duet" of the F Button Set. See "[To change the F Button Set](#)" (page [EN-32](#)).
2. Touch the **F1** button (DUET).
Duet is turned on, and the **DM** indicator appears on the display.

Displayed when Duet is on

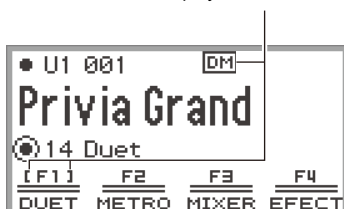

3. If necessary, change the settings for the Duet function.
 - The keyboard range can be changed in octave units, and the sound output by the left and right side of the keyboard can be split between the left and right speakers. For more information, see "[Configuring Duet Settings](#)" (page [EN-137](#)).

4. Play duets using the left and right sides of the keyboard.

- When Duet is active, the left and right pedals serve as damper pedals for the left and right-side of the keyboard, respectively, and the center pedal serves a damper pedal for both left and right.

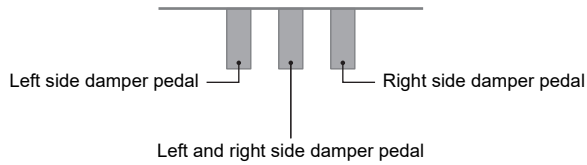

5. To turn off Duet, touch the **F1** button (DUET). The **DM** indicator disappears.

NOTE

- A sustain pedal (sold separately) can be connected to the **EXPRESSION/ASSIGNABLE** jack and used as a shared (left and right) damper pedal. Half-pedal operation is not supported.
- Some settings cannot be changed while Duet is active.
- The following functions are assigned to the **CONTROL** button, and **K1** and **K2** knobs, respectively, while Duet is active (they cannot be changed).

CONTROL button: Modulation

K1 knob: KB Group Volume

K2 knob: WirelesAudioVol

Configuring Duet Settings

1. Select the “14 Duet” of the F Button Set. See “[To change the F Button Set](#)” (page [EN-32](#)).
2. Touch and hold the **F1** button (DUET).
The “DUET” screen appears.

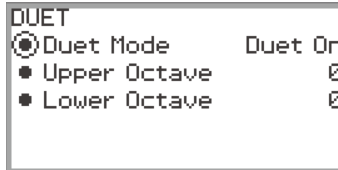

3. Touch the top or bottom of the touch ring to select the item whose setting value you want to change.
 - The table below shows the setting values and details for each setting item.

Setting Item	Setting Value	Description
Duet Mode	Duet On	Both speakers output sound from both the left and right sides of the keyboard.
	Duet Pan	The left speaker outputs sound from the left side of the keyboard only, and the right speaker outputs sound from the right side of the keyboard only.
Upper Octave, Lower Octave	-2, -1, 0, +1, +2	“Upper Octave” raises or lowers the range of the right side of the keyboard, while “Lower Octave” raises or lowers the range of the left side of the keyboard, both in octave units. Increasing the setting value by one raises the keys one octave. Decreasing it by one lowers the keys one octave (initial default setting: 0).

4. Change the setting value of the selected item.
 - Trace the touch ring to change the desired setting value.

5. Repeat Steps 3 and 4 as necessary.

NOTE

- When “Duet Mode” is set to “Duet Pan”, the Hall Simulator/Reverb (page [EN-49](#)), Surround (page [EN-49](#)), DSP (page [EN-52](#)), Chorus (page [EN-57](#)), and Acoustic Simulator (page [EN-59](#)) functions and some Mixer settings (page [EN-65](#)) are not available.

USB Flash Drive

Your Digital Piano supports the following USB flash drive operations.

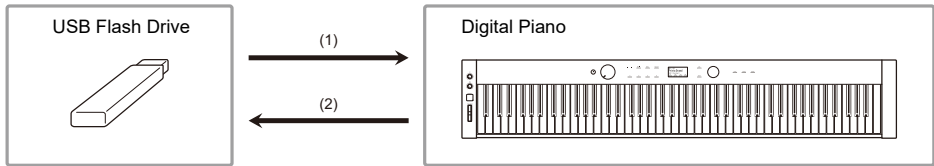

(1) USB Flash Drive on the Digital Piano

- Playing back audio data on a USB flash drive
“[Listening to Songs \(SONG Mode\)](#)” (page [EN-106](#))
- Playing back MIDI files on a USB flash drive
“[Listening to Songs \(SONG Mode\)](#)” (page [EN-106](#))
- Loading compatible files on a USB flash drive into the Digital Piano’s Internal Memory
“[Loading USB Flash Drive Data into the Digital Piano’s Internal Memory](#)” (page [EN-145](#))
- Deleting USB flash drive files
“[Deleting a USB Flash Drive File](#)” (page [EN-146](#))
- Renaming USB flash drive files
“[Renaming a USB Flash Drive File](#)” (page [EN-147](#))

(2) Saving Digital Piano Data to a USB Flash Drive

Saving the following data recorded by this Digital Piano to a USB flash drive allows you to load and use the data in the future.

- MIDI recorder songs
- Registration data
- All user data
“[Saving Digital Piano Data to a USB Flash Drive](#)” (page [EN-143](#))

Preparing a USB Flash Drive

This section explains the information below.

- USB flash drive supported for use with the Digital Piano
- Data types supported by the Digital Piano using a USB flash drive
- Connecting a USB flash drive to and detach it from the Digital Piano
- Formatting a USB flash drive

Supported USB Flash Drives

Capacity: 32GB or less recommended

IMPORTANT!

- Use a FAT (FAT32 or exFAT) format USB flash drive.
- You may not be able to use a USB flash drive that is recognized as multiple drives on your computer.
- A USB flash drive that is recognized as a CD-ROM on your computer is not supported.
- A USB flash drive with an anti-virus function and/or security functions is not supported.

Data Types Supported by the Digital Piano

Data from a USB flash drive that can be read by the Digital Piano includes song data (MIDI and audio data), registration data, and all user data stored in the Digital Piano.

■ Song Data

Audio Data

- WAV format:

This is a standard audio file format used primarily by Windows. The Digital Piano supports the following WAV file format:

Linear PCM, 16-bit, 44.1kHz, stereo, file name extension: .WAV

- MP3 format:

This is a common audio file format used widely in online music distribution, etc. This Digital Piano supports the following MP3 file formats:

MPEG-1 Audio Layer3, 44.1kHz/48kHz, 32 to 320kbps variable bit rate (VBR), monaural/stereo, file name extension: .MP3

MIDI Data

- MRF format (CASIO original file format):

MIDI data recorded with the Digital Piano's MIDI Recorder. (file name extension: .MRF)

- CMF format (CASIO original file format):

This file format adds CASIO proprietary data to MIDI data. (file name extension: .CMF)

- SMF (Standard MIDI File) Format 0/1:

Standard MIDI file format that can be exchanged with a compatible device from another manufacturer. (File name extension: .MID)

Data Type		File Name Extension	Save (Digital Piano → USB Flash Drive)	Load (USB Flash Drive → Digital Piano)	Direct Recording to USB Flash Drive	Direct USB Flash Drive Playback
Audio Data	Audio Recorder song file (page EN-122)	.WAV	—	—	Yes	Yes
	General audio file	.WAV	—	—	—	
		.MP3				
MIDI Data	MIDI Recorder song files (page EN-113)	.MRF	Yes*1	Yes	—	—
	CASIO MIDI file*2	.CMF	—	Yes*3	—	Yes
	Standard MIDI file (SMF format)	.MID				

*1 Can be converted to Standard MIDI file (SMF format 0, File name extension: .MID) for save.

- Saving as a MRF format file

In addition to performance information, model-specific settings (such as Acoustic Simulator) are also saved to the file, so you can reproduce the original performance in its entirety after reloading the data.

Note, however, that MRF file data is not compatible with other musical instrument types and models.

– Saving as an SMF format file

Performance information is saved, but models specific-settings are not saved. Because of this, playback of a reloaded file will be in accordance with the current Digital Piano setup, which may be different from the original setup. If you want to play with the original setup, you will need to configure it manually. Since this is an SMF file, it can be used on another musical instrument that supports SMF. Of course, playback will be somewhat different when played on another musical instrument.

*2 Songs downloaded from the CASIO website, etc.

*3 The song is loaded as a user song (song number 001 to 010). See “Data Types of Playable Songs” (page EN-106).

Copyrights

The rights of creators and copyright holders of music, images, computer programs, databases, and other data are protected by copyright laws. You are allowed to reproduce such works for personal or noncommercial use only. For any other purpose, all reproduction (including data format conversion), modification, transfer of reproductions, distribution over a network, or any other use without permission of the copyright holder exposes you to claims for damages and criminal prosecution for copyright infringement and violation of the author's personal rights. Be sure to reproduce and otherwise use copyrighted works only in accordance with applicable copyright laws.

■ Registration Data

Registration data from the Digital Piano can be saved to a USB flash drive as banks (extension: .RBK). RBK files can be loaded into the Digital Piano from a USB flash drive.

For details on registration, see “Saving and Recalling Performance Setups (Registration)” (page EN-86).

■ All User Data

All user data stored in the Digital Piano can be saved as a single file to a USB flash drive (extension: .DAL). Saved DAL files can be loaded into the Digital Piano from a USB flash drive.

Connecting a USB Flash Drive to and Detaching It from the Digital Piano

- Be sure to observe the precautions provided in the documentation that comes with the USB flash drive.
- Avoid using a USB flash drive under the following conditions. Such conditions can corrupt data stored on the USB flash drive.
 - Areas subjected to high temperature, high humidity, or corrosive gas
 - Areas subjected to strong electrostatic charge and electrical noise
- Never remove the USB flash drive while data is being written to or loaded from it. Doing so can corrupt the data on the USB flash drive and damage the **USB** Type A port.
- Never insert anything besides a USB device that is specified for use with this Digital Piano into the **USB** Type A port. Doing so creates the risk of malfunction.
- When you perform a USB flash drive operation while a USB flash drive is plugged in, the Digital Piano initially needs to perform a “mounting” sequence to prepare for data exchange with the USB flash drive. Digital Piano operations may be momentarily difficult while a mounting sequence is being performed. The message “MOUNTING” is displayed while the USB flash drive is being mounted. It may take up to 10 or 20 seconds or even longer for a USB flash drive to be mounted. We recommend that you do not attempt to perform any operation on the Digital Piano while a mounting sequence is in progress. A USB flash drive needs to be mounted each time it is connected to the Digital Piano.

■ To insert a USB flash drive

1. As shown in the illustration below, insert the USB flash drive into the Digital Piano's **USB** Type A port.

- Carefully push the USB flash drive in as far as it will go. Do not use undue force when inserting the USB flash drive.

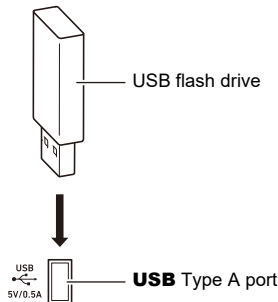

- Static electricity conducted to the **USB** Type A port from your hand or from a USB flash drive can cause malfunction of the Digital Piano. If this happens, turn the Digital Piano off and then back on again.

■ To remove a USB flash drive

1. Check to confirm that no data read/write operation is in progress.

- Do not proceed to step 2 if data is being read or written, as in the following cases:
 - If “MOUNTING” or “Wait...” is displayed on screen
 - If the USB flash drive is in use by the audio recorder or SONG mode.

2. Pull the USB flash drive straight out.

- A USB flash drive can become warm after very long use. This is normal and does not indicate malfunction.

Formatting a USB Flash Drive

Formatting a USB flash drive on the Digital Piano will create a folder named MUSICDAT in the drive's root directory if a MUSICDAT folder does not already exist there. Use this folder when exchanging data between the Digital Piano and USB flash drive.

IMPORTANT!

- Be sure to format a USB flash drive on the Digital Piano before using it for the first time.
- Formatting a USB flash drive deletes all data currently stored on it. Before formatting a USB flash drive, make sure it does not have any valuable data stored on it.
- The format operation performed by this Digital Piano is a “quick format”. If you want to completely delete all of the data in the USB flash drive, format it on your computer or some other device before formatting it with this Digital Piano.
- In the case of an exFAT format USB flash drive, the number of importable files may be limited if long file names are used.

1. Insert the USB flash drive you want to format into the **USB Type A** port on the Digital Piano.
2. Touch the **FUNCTION** button to display the **FUNCTION** Menu.
3. Use the touch ring to select “**MEDIA**” > “**FORMAT**”, then touch the **ENTER** button.

A confirmation screen appears. To cancel the operation, touch the left of the touch ring (NO).



4. To confirm the formatting, touch the right of the touch ring (**YES**).
 - Formatting begins and “Wait...” appears. Do not perform any action using the Digital Piano during this period. Formatting a large-capacity USB flash drive may take several minutes.
 - When formatting is complete, “Complete” appears.

Saving MIDI Files or Audio Files for Playback on your Digital Piano to a USB Flash Drive

The procedure below can be used to save MIDI files (SMF or CMF) and audio files (WAV or MP3) to a USB flash drive and play them back on the Digital Piano.

1. **Connect the USB flash drive to your computer.**
2. **Create a folder named MUSICDAT in the root directory of the USB flash drive.**
 - This step is not required if there is already a MUSICDAT folder in the USB flash drive's root directory.
3. **Move the MIDI files or audio files you want to play back to the MUSICDAT folder on the USB flash drive.**
 - For information about playback see "[Listening to Songs \(SONG Mode\)](#)" (page [EN-106](#)).

Copyrights

You are allowed to use recordings for your personal use. Any reproduction of an audio or music format file without the permission of its copyright holder is strictly prohibited under copyright laws and international treaties. Also, making such files available on the Internet or distributing them to third parties, regardless of whether such activities are conducted with or without compensation, is strictly prohibited under copyright laws and international treaties. CASIO COMPUTER CO., LTD. shall not be held in any way liable for any use of this Digital Piano that is illegal under copyright laws.

Saving Digital Piano Data to a USB Flash Drive

1. Touch the **FUNCTION** button to display the **FUNCTION** Menu.
2. Use the touch ring to select "**MEDIA**" > "**SAVE**", then touch the **ENTER** button.
The "MEDIA SAVE" screen displays a menu for selecting the type of data that can be saved.



"MIDI REC SONG" ... MIDI recorder songs

"REGIST BANK" ... Registration Bank

"ALL" ... All user data in the Digital Piano's internal memory

3. Touch the top or bottom of the touch ring to select the type of data to save, then touch the **ENTER** button.

- If you choose “ALL”, after touching the **ENTER** button the file name edit screen will be displayed so proceed to Step 5. Otherwise, the screen for selecting the type of data to save will be displayed so proceed to Step 4.

4. Perform the following actions depending on the type of data you selected.

■ If you selected “MIDI REC SONG”:

- (1) Touch the top or bottom of the touch ring to select the data to save, then touch the **ENTER** button.

A screen appears for selecting the file format (MRF or MID) to save the data in.

- (2) Touch the top or bottom of the touch ring to select “MRF” (dedicated format for this Digital Piano) or “MID” (SMF format), then touch the **ENTER** button.

The file name editing screen appears.

■ If you selected “REGIST BANK”:

- (1) Touch the top or bottom of the touch ring to select the data to save, then touch the **ENTER** button.

The file name editing screen appears.

5. Rename the file if necessary.

- For details, see “[To change a character](#)” (page EN-35), “[To insert a character](#)” (page EN-36), and “[To delete a character](#)” (page EN-36).

6. To confirm the file name, touch the **ENTER** button.

“Sure?” or “Replace?” appears in the screen confirming whether you want to save the file.

“Sure?” Appears when there are no files with the same name on the destination USB flash drive.

“Replace?” Confirms whether you want to overwrite an existing file with the same name on the destination USB flash drive.

- To exit the operation without saving, touch the left of the touch ring (NO).

7. To save, touch the right of the touch ring (YES).

“Wait...” is displayed during the save process. Do not perform any action on the Digital Piano while this is happening. When saving is complete, “Complete” appears.

- It may take several minutes to save all user data, depending on the size of the data.

Loading USB Flash Drive Data into the Digital Piano's Internal Memory

1. Touch the **FUNCTION** button to display the **FUNCTION** Menu.
2. Use the touch ring to select **"MEDIA"** > **"LOAD"**, then touch the **ENTER** button.
The "MEDIA LOAD" screen displays a menu for selecting the type of data you want to load.

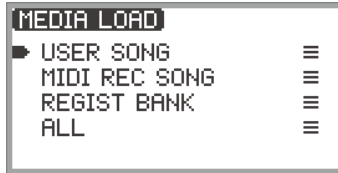

"USER SONG" ... User songs

"MIDI REC SONG" ... MIDI recorder songs

"REGIST BANK" ... Registration Bank

"ALL" ... All user data in the Digital Piano's internal memory

3. Touch the top or bottom of the touch ring to select the type of data, a file to load, then touch the **ENTER** button.

A screen appears to select which area of the Digital Piano to load.

- If "ALL" is selected, touching the **ENTER** button immediately displays the confirmation screen in Step 4 ("Replace?").

4. Touch the top or bottom of the touch ring to select the area to load from, then touch the **ENTER** button.

The "Sure?" or "Replace?" message appears in the screen confirming whether you want to load the file.

"Sure?" Appears when there is no data in the load destination.

"Replace?" Checks whether you want to overwrite the data, since there is data in the load destination.

- To exit the operation without loading any data, touch the left of the touch ring (NO).

5. To load a file into the Digital Piano, touch the right of the touch ring (**YES**).

"Wait..." is displayed during the loading process. Do not perform any action on the Digital Piano while this is happening. When loading is complete, "Complete" appears.

- It may take several minutes to load all user data, depending on the size of the data.

Deleting a USB Flash Drive File

1. Touch the **FUNCTION** button to display the **FUNCTION** Menu.
2. Use the touch ring to select “**MEDIA**” > “**DELETE**”, then touch the **ENTER** button.

The “**MEDIA DELETE**” screen displays a menu for selecting the types of files that can be deleted.



“**USER SONG**” ... User songs

“**MIDI REC SONG**” ... MIDI recorder songs

“**AUDIO REC SONG**” ... Audio recorder songs, general audio file

“**REGIST BANK**” ... Registration Bank

“**ALL**” ... All user data in the Digital Piano’s internal memory

3. Touch the top or bottom of the touch ring to select the type of file to delete, then touch the **ENTER** button.
4. Touch the top or bottom of the touch ring to select the file you want to delete.
5. Touch the **ENTER** button.
A screen (“**Sure?**”) appears to confirm whether you want to delete it.
 - To exit the operation without deleting it, touch the left of the touch ring (**NO**).
6. To delete it, touch the right of the touch ring (**YES**).

“**Wait...**” is displayed during the delete process. Do not perform any action on the Digital Piano while this is happening. When deletion is complete, “**Complete**” appears.

- It may take several minutes to delete audio recorder songs or all user data, depending on the size of the data.

Renaming a USB Flash Drive File

1. Touch the **FUNCTION** button to display the **FUNCTION** Menu.
2. Use the touch ring to select “**MEDIA**” > “**RENAME**”, then touch the **ENTER** button.

“**MEDIA RENAME**” screen appears with a menu to select the types of files that can be renamed.



“**USER SONG**” ... User songs

“**MIDI REC SONG**” ... MIDI recorder songs

“**AUDIO REC SONG**” ... Audio recorder songs, general audio file

“**REGIST BANK**” ... Registration Bank

“**ALL**” ... All user data in the Digital Piano’s internal memory

3. Touch the top or bottom of the touch ring to select the type of file to rename, then touch the **ENTER** button.
4. Touch the top or bottom of the touch ring to select the file to rename.
5. Touch the **ENTER** button.
The file name editing screen appears.
6. **Rename the file.**
 - For details of the procedure, see “[To change a character](#)” (page EN-35), “[To insert a character](#)” (page EN-36), and “[To delete a character](#)” (page EN-36).
7. **To confirm the file name, touch the ENTER button.**
The confirmation screen displays “Sure?” or “Replace?”.
“Sure?” Appears when there are no files with the same name on the destination USB flash drive.
“Replace?” Confirms whether you want to overwrite a file with the same file name on the destination USB flash drive.
 - To exit the operation without renaming (or without overwriting a file with the same name), touch the left of the touch ring (NO).
8. **To rename (or to overwrite a file with the same name), touch the right of the touch ring (YES).**

“Wait...” appears during the process. Do not perform any action on the Digital Piano while this is happening. When the process is complete, “Complete” appears.

Configuring MIDI Settings

To change the MIDI settings of the Digital Piano, use the setting items of the FUNCTION Menu (page EN-33) listed in the table below.

Setting Item	Setting Values and Descriptions
"MIDI" > "Keyboard Ch"	The keyboard channel is the MIDI channel that performance data of the Digital Piano is transmitted on to external devices. Set between 01 (default) and 16.
"MIDI" > "Local Control"	Using the Local Control setting, you can disconnect the Digital Piano's keyboard from the internal 'local' sound source so that MIDI data is only output to an external instrument. The initial default setting is "On". When set to "Off", the Digital Piano outputs performance data (MIDI data), but the Digital Piano itself does not produce any sound.
"MIDI" > "Hi-Reso MIDI Out"	Switches High Resolution Velocity MIDI Out on/off. Sets whether the key-on and key-off velocities are output as high-resolution MIDI output. <ul style="list-style-type: none">• When set to on, high-resolution velocity information compatible with the high-resolution velocity MIDI standard is sent to the MIDI OUT port.• When set to off, high-resolution velocity data is not sent to the MIDI OUT port. (Standard 127-step velocity data is sent to the MIDI OUT port.)• Turning this setting on/off only affects the data sent to the MIDI OUT port. The Digital Piano's built-in sound source always uses high-resolution velocity data.

Wireless Connections

The included Wireless MIDI & Audio Adaptor can be used to wirelessly connect the Digital Piano to external devices. This connection uses Bluetooth® wireless technology, and the following two types of connections are possible:

- Bluetooth Low Energy MIDI connection ... Transmits MIDI data between the Digital Piano and a smart device.*
- Bluetooth audio connection ... The Digital Piano produces the sound for playback of audio from the external device.

* This requires the dedicated app (page [EN-155](#)) to be installed.

Configuring Wireless (Bluetooth) Connection Settings

Checking the Wireless Connection Status

You can check the wireless connection status by referring to the indicator in the upper right corner of the top screen.



MLights while connected to a Bluetooth Low Energy MIDI-compatible device.

ALights while connected to a Bluetooth audio-compatible device.

Enabling and Disabling the Digital Piano's Wireless Function

The wireless functionality of this Digital Piano is turned on under the initial default settings. The wireless functionality can be turned off when necessary, such as when you do not want the Digital Piano to send out a signal.

1. Select the “04 Listening” of the F button set. See “[To change the F Button Set](#)” (page [EN-32](#)).

- When the wireless functionality is on, the **F1** button (ADPTR) in the F button menu is surrounded by brackets []. In addition, the indicator lights according to the status of the wireless connection. For more information, see “[Checking the Wireless Connection Status](#)” (page [EN-149](#)).



2. Touch the **F1** button (ADPTR).

The wireless functionality turns off.



- Touching the **F1** button (ADPTR) toggles the wireless functionality on and off.

Notification Tones

A change in the Bluetooth connection causes a notification tone to sound.

This type of connection:	Sounds this notification tone:
Connection with a Bluetooth audio device	Rising piano tone melody
Disconnection from a Bluetooth audio device	Falling piano tone melody
Connection with a Bluetooth Low Energy MIDI device	Rising vibraphone tone melody
Disconnection from a Bluetooth Low Energy MIDI device	Falling vibraphone tone melody

■ To adjust the notification tone volume level

1. Select the “04 Listening” of the F button set. See “[To change the F Button Set](#)” (page [EN-32](#)).

2. Touch and hold the **F1** button (ADPTR).

The “WIRELESS” screen appears.

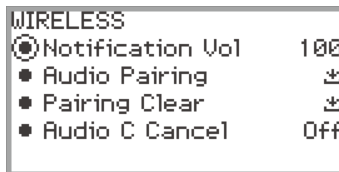

3. Trace the touch ring to change the “Notification Vol” setting value.

- The volume can be changed to a value between 0 and 127.

Connecting the Digital Piano with a Bluetooth Low Energy MIDI Device

Connecting the Digital Piano and a smart device over a Bluetooth Low Energy MIDI connection enables various actions using the dedicated app. For details about the dedicated app, see “[About the App for Smart Devices \(CASIO MUSIC SPACE\)](#)” (page EN-155).

1. If the Digital Piano’s wireless functionality is turned off, turn it on.
 - For more information, see “[Enabling and Disabling the Digital Piano’s Wireless Function](#)” (page EN-149).
2. Plug the included Wireless MIDI & Audio Adaptor into the Digital Piano’s **USB Type A port**.

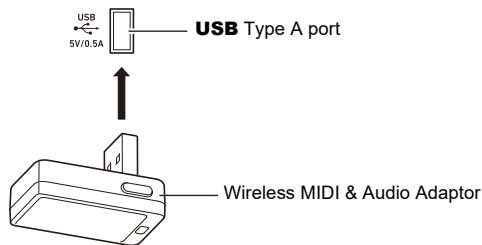

3. Open the settings screen of the smart device and turn on the **Bluetooth function** if it is off.
4. In the settings screen of the dedicated app installed on your smart device, select “**WU-BT10 MIDI**”.
 - Do not operate the Digital Piano while it is connecting to a smart device.
 - When connected, the **[M]** indicator appears in the upper right corner of the Digital Piano’s top screen and a notification tone sounds.

NOTE

- The procedure in Step 4 above is necessary every time you use the dedicated app.
- When this Digital Piano and an external device are connected via Bluetooth Low Energy MIDI and Bluetooth audio simultaneously, MIDI functionality may become unstable depending on the type of connected device, its OS version, etc. If this occurs, terminate the Bluetooth audio connection using the external device.

Connecting the Digital Piano with a Bluetooth Audio Device

Connecting this Digital Piano and an external device* over Bluetooth audio allows playback from the external device over the Digital Piano's speakers. To connect via Bluetooth audio, you must first perform a procedure called "audio pairing" between the Digital Piano and the external device.

* External devices include Bluetooth audio-compatible smart devices (e.g., iPhones, iPads, Android smartphones), iPods, MP3 players, etc.

Pairing the Digital Piano with a Bluetooth Audio Device

1. Plug the included Wireless MIDI & Audio Adaptor into the Digital Piano's **USB Type A** port.

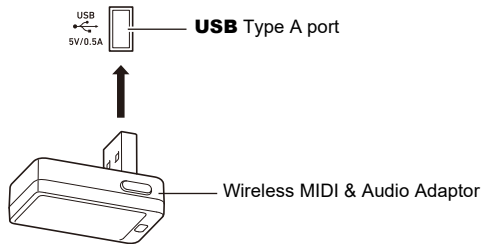

2. Open the settings screen of the external device and turn on the Bluetooth function if it is off.
3. Select the "04 Listening" of the F button set. See "[To change the F Button Set](#)" (page [EN-32](#)).
4. Touch and hold the **F1** button (ADPTR).
The "WIRELESS" screen appears.

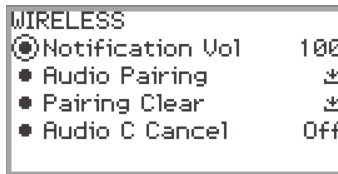

5. Use the touch ring to select "Audio Pairing" then touch the **ENTER** button.
"Pairing..." appears on the display of the Digital Piano, and it waits for the connection to be established.
 - If the Digital Piano's wireless functionality is off, it will automatically turn on.

6. Select “WU-BT10 AUDIO” on the Bluetooth settings screen of the external device.

- When pairing is complete, the  indicator appears in the upper right corner of the Digital Piano’s top screen and a notification tone sounds.

NOTE

- Information regarding the external device connected over Bluetooth audio is registered in the Wireless MIDI & Audio Adaptor. After the first time, the Bluetooth audio connection will be established automatically without the above procedure.
- If the Bluetooth audio connection cannot be established, try the following:
 - (1) Perform the operation described in “[Deleting Bluetooth Audio Device Pairing Registration](#)” (page [EN-153](#)).
 - (2) If the pairing registration information with this Digital Piano remains on the external device, delete it.
To do so, delete “WU-BT10 AUDIO” from the Bluetooth settings screen on the external device. For details on how to do this, see the instruction manual of the external device.
 - (3) Redo the procedure described in “[Pairing the Digital Piano with a Bluetooth Audio Device](#)” (page [EN-152](#)).

Deleting Bluetooth Audio Device Pairing Registration

The following procedure will delete the pairing registration between this Digital Piano and the external device connected over the Bluetooth audio connection.

NOTE

- After performing the procedure below, you should also delete the Digital Piano pairing registration information from external devices that have been connected to this Digital Piano via Bluetooth audio. To do this, delete “WU-BT10 AUDIO” from the Bluetooth settings screen of the external device. For details on how to do this, see the instruction manual of the external device.

- 1. Plug the included Wireless MIDI & Audio Adaptor into the **USB Type A** port.**
 - Bluetooth audio pairing registration information cannot be deleted unless connected.
- 2. Select the “04 Listening” of the F button set. See “[To change the F Button Set](#)” (page [EN-32](#)).**
- 3. Touch and hold the **F1** button (ADPTR).**
The “WIRELESS” screen appears.
- 4. Use the touch ring to select “Pairing Clear”, then touch the **ENTER** button.**
A confirmation screen appears. To cancel the operation, touch the left of the touch ring (NO).



- 5. To delete the pairing registration information, touch the right of the touch ring (YES).**

“Complete” appears, and the display returns to the “WIRELESS” screen.

Using the Dedicated App

This section describes the “CASIO MUSIC SPACE” dedicated app, which provides additional ways to enjoy your Digital Piano.

About the App for Smart Devices (CASIO MUSIC SPACE)

You can use the following functions on the Digital Piano when linked with the “CASIO MUSIC SPACE” dedicated app.

- Piano Roll
- Score Viewer
- Music Player
- Live Concert Simulator
- Piano Remote Controller
- Data Center

For details on each function, see the user’s manual of the dedicated app.

Follow the procedure below to use the dedicated app.

1. Install CASIO MUSIC SPACE on your smart device

- See the “Downloads” section of the website below.
<https://support.casio.com/global/en/emi/manual/PX-S6000/>



2. Connect this Digital Piano to your smart device

The available features depends on the connection method.

Never connect the Digital Piano with a Bluetooth Low Energy MIDI device and a USB MIDI device at the same time.

Available features	Wireless connection		Cable connection
	Bluetooth Low Energy MIDI connection ^{*2}	Bluetooth audio connection ^{*3}	USB MIDI connection ^{*4}
Piano Roll ^{*1}	✓	—	✓
Score Viewer	✓ (when using the pedal to turn the page)	✓	✓ (when using the pedal to turn the page)
Music Player	—	✓	—
Live Concert Simulator	✓	✓	✓
Piano Remote Controller	✓	—	✓
Data Center	✓	—	✓

*1 Use this function to transfer user songs (page [EN-106](#)) to the Digital Piano.

*2 See “[Connecting the Digital Piano with a Bluetooth Low Energy MIDI Device](#)” (page [EN-151](#)).

*3 See “[Connecting the Digital Piano with a Bluetooth Audio Device](#)” (page [EN-152](#)).

*4 See “[Connecting the Digital Piano with a Smart Device via USB MIDI](#)” (page [EN-161](#)).

Connecting with External Devices

This section describes the connection methods that can be used without using the dedicated app (page [EN-155](#)):

- Play sound from a smart device (Bluetooth audio connection)
Audio playback from a smart device or other Bluetooth audio-compatible device is played through the Digital Piano's speakers.
- Connect to a computer or smart device and use MIDI
MIDI data is transmitted between this Digital Piano and a computer or smart device.
- Output the sound of the Digital Piano to an amplifier or other audio equipment (**LINE OUT** jacks)
Sound from the Digital Piano is played through external equipment via the **LINE OUT** jacks using cables.

Playing Sound from a Smart Device on This Digital Piano (Bluetooth Audio Connection)

Connecting this Digital Piano and a smart device* over Bluetooth audio allows playback from the smart device over the Digital Piano's speakers.

* In addition to smart devices, many Bluetooth audio-compatible devices (iPods, MP3 players, etc.) can also be connected to this Digital Piano.

Playing Audio from a Smart Device or Other Bluetooth-compatible Device on this Digital Piano

- 1. Perform audio pairing between this Digital Piano and a smart device (or other Bluetooth audio-compatible device).**
 - See "[Pairing the Digital Piano with a Bluetooth Audio Device](#)" (page [EN-152](#)).
- 2. Play the song on the audio paired device.**

Adjusting the Volume Level or Effect Depth of Bluetooth Audio (MIXER Settings)

See "[Adjusting the Volume Level, Stereo Pan and Effects for Each Part](#)" (page [EN-65](#)).

- By changing the setting value of "MIXER" > "VOLUME" > "Wireless Audio", you can adjust the playback volume of audio data relative to the overall volume.
- By changing the setting value of "MIXER" > "HALL/REV." > "Wireless A Send", you can adjust the send value of the Hall Simulator/Reverb of the audio data.

Bluetooth Audio Center Cancel (Vocal Cut)

Turning on Audio Center Cancel cuts (reduces or eliminates) vocals in the playback sound. Since this function cancels the central sound, it may also cut sounds other than vocals. Its effectiveness depends on the input sound.

NOTE

- The Audio Center Cancel (page [EN-110](#)) when playing back audio data in SONG mode on this Digital Piano and the Center Cancel in this section differ in terms of settings.

■ To enable or disable Bluetooth audio center cancel

1. Select “04 Listening” from the F button set. See “[To change the F Button Set](#)” (page [EN-32](#)).
2. Touch and hold the **F1** button (ADPTR).
The “WIRELESS” screen appears.
3. Touch the top or bottom of the touch ring to select “Audio C Cancel”.



4. Trace the touch ring to toggle the setting value between “On” and “Off”.

Using MIDI with a Connected Computer or Smart Device

You can send and receive performance information (MIDI data) by connecting the Digital Piano to a computer or smart device. You can use music software on your computer or a smart device app to record your performance, or to send MIDI data from your computer or a smart device to the Digital Piano and play notes on the Digital Piano.

NOTE

- For detailed MIDI specifications relating to this Digital Piano and the latest support information, visit the CASIO website below.
<https://support.casio.com/global/en/emi/manual/PX-S6000/>



- For MIDI-related settings, see “Configuring MIDI Settings” (page EN-148).

Connecting the Digital Piano with a Computer via USB MIDI

■ Minimum Computer System Requirements

The minimum computer system requirements for sending and receiving MIDI data are shown below. Check to make sure that your computer complies with these requirements before connecting the Digital Piano to it.

- USB port
 - Operating System
 - Windows 10*
 - Windows 11
 - macOS 10.15, 11, 12, 13
- * Windows 10 (32-bit, 64-bit)

NOTE

- For the latest OS support information, please see the “Operating System Compatibility (Windows/macOS)” section on our website below.
<https://support.casio.com/global/en/emi/manual/PX-S6000/>



■ To connect the Digital Piano with your computer

IMPORTANT!





- Make sure you follow the steps of the procedure below exactly. Connecting incorrectly can make data send and receive impossible.
- Be sure to turn on the Digital Piano first before starting up your computer's music software.
- USB send and receive is disabled during playback of a song.

1. Turn off the Digital Piano and start up the computer.

- Do not start any music software yet on your computer.

2. Connect the **USB Type B** port of the Digital Piano to your computer using a commercially available **USB cable**.

- Use a USB 2.0 or 1.1 A-B connector type cable.

Computer port	Connection cable	Digital Piano port
USB Type A 		USB Type B  

3. Turn on the Digital Piano.

- When connecting for the first time, the driver required to send and receive data is automatically installed on the computer.

4. Start the (commercially available) music software on your computer.

5. Select “CASIO USB-MIDI” as the MIDI device in the settings of your computer’s music software.

- Refer to the user manual of the music software for information on how to select a MIDI device.

NOTE

- After one successful connection, the USB cable can be left connected and the computer or the Digital Piano can be turned on again.

Connecting the Digital Piano with a Smart Device via USB MIDI

Smart Device Operating Environment

You can use MIDI standard apps when the Digital Piano is connected with a smart device.

For a list of devices that can be used, please see the “Operating System Compatibility (iOS/Android)” section on the CASIO website below.

<https://support.casio.com/global/en/emi/manual/PX-S6000/>









- We recommend using devices listed in the “Tested devices (USB-MIDI connection)” section.
- Please note that listed devices are not guaranteed to work with all MIDI apps running on the device.
- Depending on the operating environment, it may not be possible to connect correctly.
- Even if the device has been tested, it may not work properly due to device or OS version upgrades, etc.

To connect the Digital Piano with your smart device

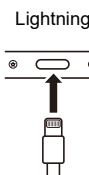



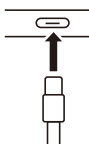

- Be sure to use a USB cable that supports data transfer.
- A USB cable exclusively for charging cannot be used for data transfer.

1. Turn on the Digital Piano and the smart device.
2. Connect the smart device to the **USB Type B** port of the Digital Piano using a connection cable.

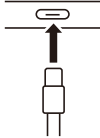
iPhone/iPad users

Device port	Connection cable	Digital Piano port
 <p>Lightning</p>	 <p>Apple Lightning - USB camera adaptor</p> <p>USB cable (A-B type)</p>	 <p>USB Type B</p>  <p>USB</p>
 <p>USB Type C</p>	 <p>Apple USB Type C - USB adaptor</p> <p>USB cable (A-B type)</p>	

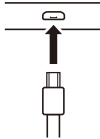
Android users

Device port	Connection cable	Digital Piano port
USB Type C 	 USB cable (C-B type) or  USB Type C - USB adaptor USB cable (A-B type)	USB Type B 
USB Micro-B 	 USB OTG cable (micro B-A type) USB cable (A-B type)	

3. Launch the MIDI-compatible app on your smart device.

- If you are using CASIO's dedicated app, the smart device screen will display "Connecting...". When a successful connection is made, the message "Connected" will be displayed.

Outputting Digital Piano Notes Through an Amplifier or Audio Equipment (LINE OUT jacks)

You can connect audio equipment or a music amplifier to the Digital Piano and then play through external speakers for more powerful volume and better sound quality. Use commercially available cable for connection.

IMPORTANT!

- Turn off the external device when making connections. After connecting, turn down the Digital Piano and external device volume levels to their minimum whenever turning power on or off.
- After connecting, turn on the Digital Piano and then the external device.
- If keyboard notes are distorted when they are sounded from external audio equipment, lower the Digital Piano's volume setting.

Connecting to Audio Equipment

LINE OUT R jack output is right channel sound, while **LINE OUT L/MONO** jack output is left channel sound. Use commercially available cables to connect the external audio equipment to the Digital Piano's LINE OUT jacks as shown in the figure below. Normally in this configuration you must set the audio equipment's input selector to the setting that specifies the terminal (such as AUX IN) to which the Digital Piano is connected.

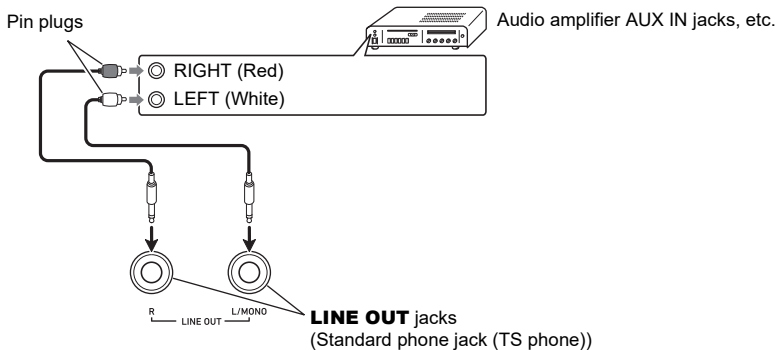

Connecting to a Musical Instrument Amplifier

Connecting to the **LINE OUT L/MONO** jack only outputs a mixture of both channels. Use commercially available cable to connect the amplifier to the Digital Piano's **LINE OUT L/MONO** jack as shown in the figure below.

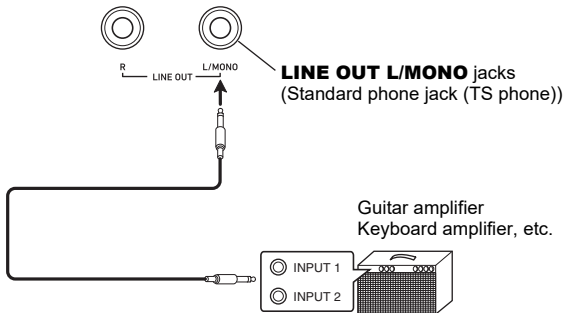

Deleting All Data in the Digital Piano's Internal Memory

All system contents, including data and settings, can be reset to their initial factory defaults.

- To return all Digital Piano settings and data to their initial factory defaults (Factory Reset)

IMPORTANT!

- Performing the following will also delete user songs, MIDI recorder songs, registration data and user F button sets. We recommend saving important data on a USB flash drive (page EN-143).

1. Touch the **FUNCTION** button to display the **FUNCTION** menu.
2. Using the touch ring, select “SYSTEM” > “Factory Reset”.

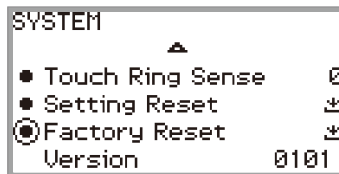

3. Touch the **ENTER** button.

A confirmation screen will appear. To cancel the operation, touch the left of the touch ring (NO).



4. To restore the Digital Piano to its initial factory defaults, touch the right of the touch ring (YES).

This restarts the Digital Piano, and then the display returns to the top screen.

- To return all Digital Piano settings to their initial factory defaults (Setting Reset)

This function allows you to restore all settings of the Digital Piano to the initial factory defaults. This operation resets only the settings and does not delete user songs, MIDI recorder songs or registration data.

In step 2 of “To return all Digital Piano settings and data to their initial factory defaults (Factory Reset)” (page EN-165), select “Setting Reset” instead of “Factory Reset”.

Troubleshooting

● The touch button does not respond.

- Reason:**
- The buttons were touched with a fingernail or stylus. The button was touched by a user wearing a glove that is not suitable for use with touch buttons.
 - The sensitivity of the touch buttons is set too low.

- Solution:**
- Touch the buttons firmly with bare fingers.
 - Change the sensitivity setting of the touch buttons. See “[Setting the Sensitivity of the Touch Buttons and Touch Ring](#)” (page [EN-26](#)).

● No sound is produced when the keyboard keys are pressed.

- Reason:**
- The volume has been turned down with the volume knob.
 - Headphones are connected. A headphone conversion plug has been left in the **PHONES** jack.
 - “Speaker Out” (page [EN-20](#)) is set to “Off”.
 - Local control setting is off.
 - The position of the expression pedal connected to the Digital Piano is at the position where it stops when depressed toward the heel (the minimum value).

- Solution:**
- Turn the volume knob.
 - Unplug the headphones or conversion plug from the **PHONES** jack.
 - Set “Speaker Out” to “Auto” or “On”.
 - Turn on the Local Control (page [EN-148](#)) setting.
 - If the “Expression” or “Master Vol” function is assigned to the expression pedal, sound will not be produced when the pedal is in the minimum value heel position. Press the pedal down toward the toe to increase the volume.

● The pitch sounds wrong.

- Reason:**
- The keyboard transpose setting has been changed from its initial value.
 - The master tuning setting is set to a frequency other than 440.0 Hz.
 - Octave Shift is enabled.
 - The Scale Tuning is set to something other than equal temperament.
 - The pitch bend wheel is not centered.

- Solution:**
- Reset transpose (page [EN-130](#)) to its initial value or turn the power off and then on again.
 - Set tuning (page [EN-130](#)) to 440.0 Hz. Or turn the power off and then on again.
 - Set octave shift (page [EN-132](#)) to “0”.
 - Set the Scale Tuning (page [EN-133](#)) to “equal temperament”.
 - Make sure nothing is touching the pitch bend wheel.

● The pedal has no effect.

- Reason:**
- The pedal cable is not properly plugged into the **PEDAL UNIT** or **EXPRESSION/ASSIGNABLE** jack. Or the plug is incompletely plugged in.
 - The pedal type assignment or function assignment to the jack to which the pedal is connected is incorrect.

- Solution:**
- Check that the pedal cable is properly connected and that the plug is firmly inserted into the jack.
 - Change to the correct settings. See “[EXPRESSION/ASSIGNABLE jack](#)” (page [EN-68](#)).
-

● The sound does not become louder or softer depending on how I play (touch).

- Reason:** “Touch Response” (page [EN-128](#)) is set to “Off”.

- Solution:** Set “Touch Response” to a setting other than “Off”.
-

● The sound tone, effects, etc. do not change even after turning the power off and then back on (the Digital Piano does not return to its initial default settings).

- Reason:** “Auto Resume” (page [EN-17](#)) is set to “On”.

- Solution:** Turn “Auto Resume” to “Off” and turn the power off and then back on.
-

● When connected to a computer, MIDI cannot be sent or received.

- Solution:**
- Check that the Digital Piano is properly connected to the computer with a USB cable and that the Digital Piano is correctly selected in the settings of the computer’s music software.
 - Try turning off the Digital Piano and closing the music software on the computer, then turn on the Digital Piano and restart the music software on the computer.
-

● Some tones are the same but have slightly different sound quality and volume depending on the keyboard position.

- Reason:** This is not a malfunction, but a result of an electronic process called digital sampling*.
- * A process whereby several tone registers (low, mid, high, etc.) of the original instrument are recorded to capture the sound quality in each of the original instrument sound registers. The samples are then processed to create a single tone.
-

● When the buttons are pressed, the sound that is being played is temporarily interrupted or the sound quality becomes slightly different.

- Reason:** When using the Layer function, Duet function, song playback, or recording function, multiple parts sound at the same time. Pressing the buttons in such cases will automatically change the internal effect settings specific to the tone and may cause this phenomenon to occur in some parts, but it is not a malfunction.
-

Error Messages

Display	Cause	Action
Limit	Recording of 1,000 measures or over was attempted with the MIDI recorder.	Use the MIDI recorder to record up to bar 999.
	The recording time limit was reached with the audio recorder.	Use the audio recorder to record up to approximately 25 minutes.
Memory Full	The per-song capacity (320KB) of the MIDI recorder was reached.	Record within the per-song capacity.
Data Full	The five-song limit was reached with the MIDI recorder.	Delete a song (page EN-119).
No Media	The USB flash drive is not properly plugged into the USB Type A port on the Digital Piano.	Plug the USB flash drive correctly into the USB Type A port.
	The USB flash drive was removed or inserted during the operation.	Do not touch the USB flash drive during operation of the Digital Piano.
	The USB flash drive is protected.	Unprotect the USB flash drive.
	The USB flash drive contains antivirus software.	Use a USB flash drive that does not contain antivirus software.
No File	There are no loadable/playable files in the "MUSICDAT" folder.	Move the file you want to load or play to the "MUSICDAT" folder (page EN-143).
No Data	An attempt was made to save a song number to the USB flash drive for which there was no recorded data.	Select a song number that has already been recorded.
Read Only	An attempt was made to save different data with the same name as a read-only file on the USB flash drive.	<ul style="list-style-type: none"> • Change the name to something else and save it. • Remove the read-only attribute from the file on the USB flash drive and overwrite the file. • Use a different USB flash drive.
Not Enough Memory	If this error appears, there is not enough free space on the USB flash drive.	Either delete the files stored on the USB flash drive to free up more space or use a different USB flash drive.

Display	Cause	Action
Too Many Files	When recording with the audio recorder, an attempt was made to start recording beyond the maximum number of songs (99), or there is a file called TAKE99.WAV in the "MUSICDAT" folder of the USB flash drive.	Use a computer to delete all or some of TAKE01.WAV to TAKE99.WAV in the "MUSICDAT" folder or move them to another folder or drive. When deleting or moving only some files, give priority to files with higher numbers*.
Not SMF 0/1	An attempt was made to read or play a file in SMF format 2.	The SMF format that can be read and played back by the Digital Piano is "0" or "1".
Large Size	The size of the SMF file on the USB flash drive is too large to play on this Digital Piano.	The Digital Piano can play back SMF files up to a maximum size of approximately 320 KB.
Wrong Data	Data on the USB flash drive is corrupted.	—
Version	The version of the file on the USB flash drive is not the version supported by this Digital Piano.	Use a version of the file that is supported by the Digital Piano.
Format	The format of the USB flash drive is not compatible with this Digital Piano.	Use a computer or other device to change the USB flash drive to a format compatible with this Digital Piano (page EN-142). Use another USB flash drive.
	The USB flash drive is corrupted.	Use another USB flash drive.
No Wireless Adptr	The Wireless MIDI & Audio Adaptor is not plugged into the USB Type A port.	Plug the Wireless MIDI & Audio Adaptor into the USB Type A port.

* Audio recorder songs are saved with the name "TAKE**" (** is 01 to 99). Whenever recording, data is automatically created by adding 1 to the highest number of ** in the USB flash drive. Therefore, if "TAKE99" in the SONG mode screen is marked with "*" (data of "TAKE99" exists), recording will not be able to start.

Reference

Product Specifications

Model	PX-S6000BK
Keyboard	88-key piano keyboard
Settings	Hammer Response, Key Off Response
Duet	Adjustable tone range (-2 to +2 octaves)
Transpose	-12 to 0 to +12 semitones
Octave Shift	-2 to 0 to +2 octaves
Sound Source	
Number of Tones	350, Layer, Split
Maximum Polyphony	256 notes
Touch Response	5 sensitivity levels, Off
Tuning	415.5Hz to 440.0Hz to 465.9Hz (0.1Hz units)
Temperament	Equal temperament plus 16 other types
Piano Position	4 types
Acoustic Simulator	Key Off Simulator, String Resonance, Damper Resonance, Damper Noise, Key On Action Noise, Key Off Action Noise
Sound Mode	Hall simulator (8 types), Reverb (8 types), Surround (3 types)
DSP	Built-in to each tone + 100 presets, editable
Effects	Chorus (12 types), Brilliance (-12 to 0 to +12)
Microphone Effect	25 types, editable effect parameter settings
Mixer	Volume, Pan, Hall Simulator/Reverb Send, Hall Simulator/Reverb Return, Chorus Send
Demo Song	3
Playback Function (SONG Mode)	
In the MIDI Mode	Playable songs: User song* ¹ (SMF* ² , CMF* ³), MIDI recorder song (MRF* ⁴), song data stored on USB flash drive (SMF* ² , CMF* ³) Playback parts: L+R, L, R (playback of both tracks at the same time or each track independently)
In the Audio Mode	Playable songs: audio recorder song (WAV* ⁵), general audio file (WAV* ⁵ , MP3* ⁶) Playback functions: Center cancel
Song Volume	Adjustable (MIDI Mode and Audio Mode individually)
MIDI Recorder	Real-time recording and playback as MIDI data
Number of Songs	5
File Format	MRF* ⁴
Number of Tracks	2
Capacity	Approximately 30,000 notes per song (total of two tracks)
Recording Medium	Internal memory (built-in flash memory)

Audio Recorder	Real-time recording and playback as audio data
Number of Songs	99 (files)
File Format	WAV*5
Maximum Recording Time	Approximately 25 minutes per file
Recording Medium	USB flash drive
Arpeggiator	50 types
Metronome	
Beat Bell	Off, 1 to 9 (beats)
Drum Patterns	20 types
Tempo Range	20 to 255
Tempo Markings	9 types
Metronome Volume Level	Adjustable
Registration Function	96 sets maximum (4 sets, 24 banks)
Pedals	
PEDAL UNIT jack	For connection of a separately available pedal unit Damper (continuously variable), sostenuto (off, on), soft (off, on)
EXPRESSION/ ASSIGNABLE jack	For connection of the included sustain pedal (SP-3), a commercially available expression pedal or a separately available CASIO sustain pedal, selectable function (expression, master volume, tempo, layer balance, damper (off, on), sostenuto (off, on), soft (off, on), arpeggio hold (off, on), play/stop, sequential recall of setup registrations)
Other Functions	Auto Resume, Operation Lock
MIDI	MIDI 16-channel multi-timbre receive; GM Level 1 standard
Pitch Bend Wheel	Pitch bend range: 0 to 24 semitones
Knobs	2 (function-assignable knobs)
CONTROL Button	1 (function-assignable button)
Inputs/Outputs	
PHONES jack	Stereo standard phone jack (TRS phone) × 1, Stereo mini phone jack (Mini TRS phone) × 1
Power	24V DC
LINE OUT R, L/MONO jacks	Standard phone jack (TS phone) × 2 (Output impedance: 470 Ω, Output voltage: 1.7 V (RMS) MAX)
MIC IN jack	Standard phone jack (TS phone) (Input impedance: 3 kΩ, Input voltage: 10 mV)
USB Ports	Type A, Type B
EXPRESSION/ ASSIGNABLE jack	Stereo standard phone jack (TRS phone)
PEDAL UNIT jack	Proprietary jack
Acoustics	
Amp output	8 W × 2 + 8 W × 2 (3 W × 2 + 3 W × 2 under battery power)
Speakers	16 cm × 8 cm (oval) × 2 + 16 cm × 8 cm (oval) × 2

Power Supply	2-way
Batteries	8 AA-size alkaline batteries or AA-size rechargeable nickel metal hydride batteries
Battery Continuous Operation	Approximately 4 hours (alkaline batteries), approximately 4 hours (rechargeable nickel metal hydride batteries) ^{*7} Actual continuous operation time may be shorter due to battery type and performance type.
AC Adaptor	AD-E24250LW
Auto Power Off	Approximately four hours (under AC adaptor power) or six minutes (under battery power) after last operation, can be disabled.
Power Consumption	24V --- 20W
Dimensions	134.0 (W) × 24.2 (D) × 10.2 (H) cm (52 3/4 × 9 1/2 × 4 inch)
Weight	Approximately 14.8 kg (32.6 lbs) (Excluding batteries)

*1 Storage of up to 10 songs in the internal memory, up to approximately 320KB per song (Based on 1KB = 1024 bytes, 1MB = 1024² bytes)

*2 Standard MIDI file (SMF format 0/1, file name extension: .MID)

*3 CASIO original file format. This file format adds CASIO proprietary data to MIDI data. (file name extension: .CMF)

*4 MIDI Recorder song file (file name extension: .MRF)

*5 WAV format audio file (Linear PCM, 16-bit, 44.1kHz, stereo, file name extension: .WAV)

*6 MP3 format audio file (MPEG-1 Audio Layer3, 44.1kHz/48kHz, 32-320kbps variable bit rate (VBR), monaural/stereo, file name extension: .MP3)

*7 Measured values while using eneloop batteries.
eneloop is a registered trademark of Panasonic Group.

- Specifications and designs are subject to change without notice.

Operating Precautions

■ Environment

- Place the Digital Piano onto a stable and flat surface. If you want to place the Digital Piano on a table or other surface instead of a separately available stand, place it on a stable and flat surface where the entire bottom of the Digital Piano fits within that surface.
- To prevent the formation of mold, set up the product in a well-ventilated location where the temperature and humidity ranges shown below are maintained.
 - Recommended temperature range: 15 to 25°C
 - Recommended humidity range: 40 to 60% RH
- Do not set up the product in locations subject to extreme variations in temperature and/or humidity. Doing so can cause metal components to rust, coatings to degrade, and components to warp and split.

■ User Maintenance

- Wipe the product with a soft, dry cloth. Do not use a tissue, which can cause scratching.
- When soiling is more serious, moisten a soft cloth with a weak solution of water and a mild neutral detergent, wring out all excess moisture from the cloth, and then wipe the product. After that, wipe again with a separate soft dry cloth.
- Do not use any cleaning agents, chlorine disinfectants, sanitizing wipes, or other items that include benzene, organic solvents, alcohol, or other solvents for cleaning. Doing so can cause discoloration, deformation, paint peeling, cracking, etc.

■ Sterilization and Disinfection

- After wiping the product two or three times with a non-alcohol sanitizing wipe, use a soft, dry cloth to wipe it dry.
- Note that failure to wipe the product dry can cause streaks to remain.
- If the product is used by multiple parties, hand disinfection before each use is recommended.

■ Included and Optional Accessories

Use only accessories that are specified for use with this product. Use of unauthorized accessories creates the risk of fire, electric shock, and personal injury.

■ Weld Lines

Lines may be visible on the exterior of the product. These are “weld lines” that result from the plastic molding process. They are not cracks or scratches.

■ AC Adaptor Handling Precautions

- Never connect the AC adaptor (JEITA Standard, with unified polarity plug) that is specified with this Digital Piano to any other device besides this Digital Piano.
Doing so creates the risk of malfunction.
- The AC adaptor cannot be repaired. If your AC adaptor malfunctions or becomes damaged, contact your original retailer or a CASIO Service Center.
- AC adaptor operating environment: Temperature: 0 to 40°C
Humidity: 10% to 90% RH
- Output polarity: 
- Use of a different type AC adaptor can cause smoking or malfunction.

■ Using Batteries

IMPORTANT!

- Close the battery case lid before using the Digital Piano. Failing to do so may cause injury.
- Note that the rear of the Digital Piano around the battery compartment may become hot in use.

■ Rechargeable Batteries

Note the precautions below when using rechargeable batteries.

(Models that support use of rechargeable batteries only)

- Use Panasonic Group AA-size eneloop rechargeable batteries.
Do not use any other type of batteries.
- Use only the specified charger to charge batteries.
- Rechargeable batteries must be removed from the product for charging.
- For information about using eneloop batteries or their specified charger, be sure to read the user documentation and precautions that come with each item, and use them only as directed.

Be sure to replace batteries at least once a year, even if there is no indication of low battery power.

Dead rechargeable batteries (eneloop) in particular may deteriorate if they are left in the product.

Remove rechargeable batteries from the product as soon as possible after they go dead.

■ About the front panel

Operating the front panel when it is dusty or dirty may scratch it.

Gently wipe the panel with a soft, clean cloth to remove dust and dirt before use.

Use your fingers to operate the front panel. Using fingernails or sharp objects may scratch the surface.

■ Moving or Installing the Product

When installing or moving this product, be sure to pick it up from below using both hands. Particularly on models with a stand, this product should always be moved by two adults holding the product level with one person at each end, after first disconnecting any cables.

Failure to do so could result in personal injury to those around you, the product being dropped, or other unexpected accidents.

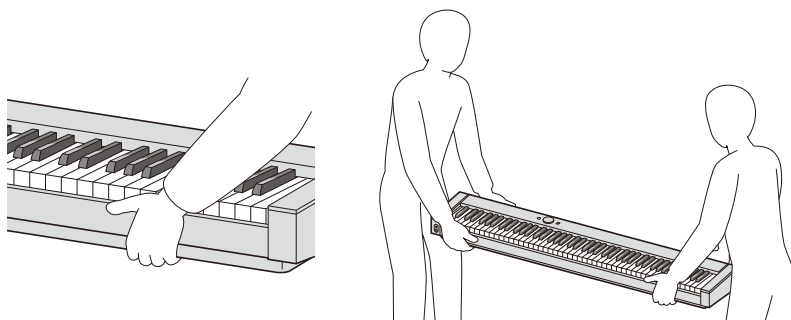

■ Plugging In and Unplugging the Product

- Grasp the base of the plug and keep it level as you push it into or pull it out of the socket.
- Do not unplug it by pulling on the cord.
- Before moving this product, be sure to unplug it from the socket.
Failure to do so could result in an accident or fault.

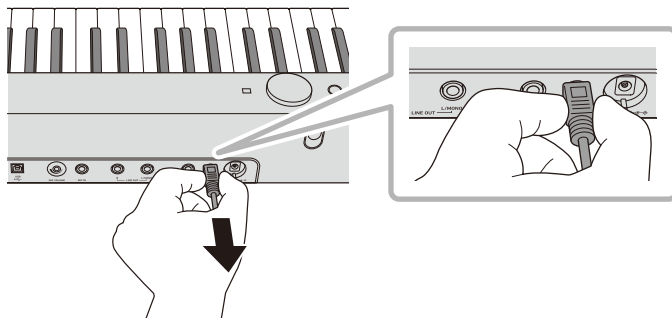

FUNCTION Menu Items

Listed below are all FUNCTION menu item names and setting values and references in this manual. Some menu items can be called up directly at the touch of a button. The following information is provided in the "Reference" column of the table below, in the following manner.

- Items below that start with "◆" indicate a button operation.
- Names enclosed in brackets [], such as "[WHEEL]", are the display name of the F button (page EN-94).
- "FUNCTION + F1" indicates "while touching the **FUNCTION** button, touch the **F1** button".

While touching the **FUNCTION** button, touch either up, down, left, or right of the touch ring to recall the initial value of each menu item.

Menu Item	Setting Values	Reference
SOUND		"Applying Effects" (page EN-49)
ACOUSTIC SIM.		"Adjusting Acoustic Piano Sound Characteristics (Acoustic Simulator)" (page EN-59) (◆[ACSIM])
String Reso.	Tone, Off, 1 - 10	"List of Acoustic Piano Sound Setting Items" (page EN-60)
Damper Reso.		
Damper Noise		
Key On Noise		
Key Off Noise		
EFFECT		(◆[EFFECT])
Chorus Type	Tone, other options*1	"Using Chorus (Chorus, Flanger, Short Delay)" (page EN-57)
Brilliance	-12 - 0 - +12	"Adjusting Brilliance" (page EN-58)
SOUND MODE		"Using the Sound Mode Effects (Hall Simulator/Reverb and Surround)" (page EN-49) (◆Touch and hold [SMODE])
Sound Mode	Off, Hall/Rev., Surround, Hall/Rev. + Srnd	"Enabling or Disabling the Hall Simulator/Reverb and Surround Effects" (page EN-49) (◆[SMODE])
Hall/Rev. Type	Options*1	"Specifying the Hall Simulator/Reverb Type" (page EN-50)
Surund Type	Type 1 - Type 3	"Specifying the Surround Type" (page EN-51)
DSP		"Configuring DSP Settings" (page EN-53) (◆Touch and hold [DSP])
DSP Type	Options*5	"Selecting a DSP Type" (page EN-53)
DSP On/Off	On, Off	"Configuring DSP Settings" (page EN-53)
M1 - M4	Options*6	

Menu Item	Setting Values	Reference
PIANO POSITION		(◆[PPOS])
Piano Position	Standard, Wall, Center, Table	“ Selecting the Piano Position Setting ” (page EN-38)
MIC FX		(◆Touch and hold [MICFX])
Mic Fx Type	Options*2	“ Specifying the Microphone Effect Type ” (page EN-62)
Fx On/Off	On, Off	“ Changing Microphone Effect Settings ” (page EN-63)
M1 – M3	Options*3	

MIXER		“ Using the Mixer ” (page EN-65) (◆[MIXER])
VOLUME		“ Adjusting the Volume Level, Stereo Pan and Effects for Each Part ” (page EN-65)
KB Group	0 - 127	“ List of Mixer Setting Items ” (page EN-66)
U1 Part		
U2 Part		
L Part		
Audio Song		
Wireless Audio		
Mic In		
MIDI Song		
PAN		“ Adjusting the Volume Level, Stereo Pan and Effects for Each Part ” (page EN-65)
U1 Part	-64 - 0 - +63	“ List of Mixer Setting Items ” (page EN-66)
U2 Part		
L Part		
Mic In		
HALL/REV.		“ Adjusting the Volume Level, Stereo Pan and Effects for Each Part ” (page EN-65)
Hall/Rev. Return	0 - 127	“ List of Mixer Setting Items ” (page EN-66)
U1 Part Send		
U2 Part Send		
L Part Send		
AudioSongSend	0 - 127	
Wireless A Send		
Mic In Send		

Menu Item	Setting Values	Reference
CHORUS		"Adjusting the Volume Level, Stereo Pan and Effects for Each Part" (page EN-65)
U1 Part Send	0 - 127	"List of Mixer Setting Items" (page EN-66)
U2 Part Send		
L Part Send		
KEYBOARD		(◆[KEYBD])
TRANSPOSE		—
Transpose	-12 - 0 - +12	"Changing the Pitch in Semitone Steps (Transpose)" (page EN-130) (◆[TRANS])
KBD SETTING		—
Touch Response	Off, Light 2, Light 1, Normal, Heavy 1, Heavy 2	"Changing Touch Response Sensitivity" (page EN-127)
Hammer Response	Tone, Off, 1 - 10	"Adjusting the Hammer Response" (page EN-128)
KeyOff Response	Tone, 1 - 3	"Adjusting the Key-off Response" (page EN-129)
PART OCT SHIFT		—
Upper1 Part	-2 - 0 - +2	"Using Octave Shift Separately for Each Part (Upper 1/Upper 2/Lower)" (page EN-132)
Upper2 Part		
Lower Part		
PART FINE TUNE		—
Upper1 Part	-99 - 0 - +99	"Adjusting the Tuning Separately for Each Part (Upper 1/Upper 2/Lower) (Part Fine Tune)" (page EN-131)
Upper2 Part		
Lower Part		
SCALE TUNING		"Changing the Scale Tuning (Temperament) of the Keyboard" (page EN-133)
Scale Type	Options* ¹	"Changing the Scale" (page EN-133)
Scale Base Note	C, C#, ... , Bb, B	
Stretch Tuning	Off, On	"Enabling or Disabling Piano Stretch Tuning" (page EN-134)
SPLIT POINT		"Changing the Split Point" (page EN-47)
Split Point	A0 - C8	(◆Touch and hold [SPLIT])

Menu Item	Setting Values	Reference
PEDAL/WHEEL		“Changing the Sound During a Performance” (page EN-67)
EXP/ASGN. PEDAL		“EXPRESSION/ASSIGNABLE jack” (page EN-68) (◆[PEDAL])
Pedal Type	SW, Exp.Type1, Exp.Type2	“To specify the pedal type” (page EN-68)
Pedal Target	Options*1	“To specify the pedal function” (page EN-69)
Upper1 Part	Off, On	“Enabling/Disabling the Pedal Operation for Each Part (Upper 1/Upper 2/Lower)” (page EN-71)
Upper2 Part		
Lower Part		
Exp Calibration	—	“Expression Pedal Calibration” (page EN-70)
PEDAL UNIT		“PEDAL UNIT jack” (page EN-67)
Upper1 Part	Off, On	“Enabling/Disabling the Pedal Operation for Each Part (Upper 1/Upper 2/Lower)” (page EN-71)
Upper2 Part		
Lower Part		
WHEEL		“Using the Pitch Bend Wheel” (page EN-79) (◆[WHEEL])
P Bend Range	0 - 24	“Changing the Pitch Bend Range” (page EN-79)
Upper1 Part	Off, On	“Enabling/Disabling the Pitch Bend Wheel Operation for Each Part (Upper 1/Upper 2/Lower)” (page EN-80)
Upper2 Part		
Lower Part		
KNOB		“Using the Knobs” (page EN-72) (◆[KNOB])
K1 Assign	Options*1	(◆FUNCTION + K1)
K2 Assign		(◆FUNCTION + K2)

Menu Item	Setting Values	Reference	
CONTROL		"Selecting the Function Assigned to the CONTROL Button" (page EN-77) (◆[CTRL])	
Control Assign	Options* ¹	"Selecting the Function Assigned to the CONTROL Button" (page EN-77) (◆FUNCTION + CONTROL)	
Mod Value	0 - 127		
Mod Upper1 Part	Off, On	"To change the Modulation settings" (page EN-78)	
Mod Upper2 Part			
Mod Lower Part			
F BUTTON SETTING		"Editing an F Button Set" (page EN-95)	
FB SET NAME EDIT		"Changing the Name of an F Button Set" (page EN-100)	
F BUTTON EDIT			
F1 {function}	Options* ¹	(◆FUNCTION + F1)	"Assigning a Function to an F Button (Creating a User F Button Set)" (page EN-95)
F2 {function}		(◆FUNCTION + F2)	
F3 {function}		(◆FUNCTION + F3)	
F4 {function}		(◆FUNCTION + F4)	
FB SET CLEAR		"Erasing an F Button Set" (page EN-102)	
DUET		"Splitting the Keyboard for Duet Play" (page EN-135) (◆Touch and hold [DUET])	
Duet Mode	Duet On, Duet Pan		
Upper Octave	-2 - 0 - +2	"Configuring Duet Settings" (page EN-137)	
Lower Octave			
ARPEGGIATOR		—	
Pattern	Options* ¹		
Recommended Setup	Off, On		
Arpeggio Hold	Off, On	"Changing the Arpeggiator Pattern and Other Settings" (page EN-84) (◆Touch and hold [ARPEG])	
Upper1 Part	Off, On		
Upper2 Part	Off, On		
Lower Part	Off, On		

Menu Item	Setting Values	Reference
REGISTRATION		“Saving and Recalling Performance Setups (Registration)” (page EN-86)
FREEZE		“Freeze Function” (page EN-90) (◆Touch and hold [FREEZ])
Pedal/Wheel	Off, On	“Registration Memory Data” (page EN-92)
Knob/CTRL		
Scale Tuning		
Touch Response		
Sound Mode		
Effect		
Transpose		
Split Point		
Arpeggiator		
Tempo		
Tone		
Mixer		
BANK NAME EDIT		“Changing a Registration Bank Name” (page EN-88)
SONG		“Listening to Songs (SONG Mode)” (page EN-106)
Song Type	MIDI, Audio (USB Drv)	“Playing Back MIDI Data or Audio Data” (page EN-107) (◆[STYPE])
Audio C Cancel	Off, On	“Audio Center Cancel (Vocal Cut)” (page EN-110) (◆[STYPE])
METRONOME		(◆[METRO])
Tempo	20 - 255	“Changing the Metronome Settings (Tempo, Beat, Pattern, etc.)” (page EN-81)
Tempo Mark	Options* ¹	
Guide Type	Metronome, Drum	
Pattern	Bell Off, 1 Beat - 9 Beat / Options* ¹	
Volume	0 - 127	
While Playing	Off, On	
While Recording	Off, On	

Menu Item	Setting Values	Reference
MEDIA		"USB Flash Drive" (page EN-138)
WIRELESS		(◆Touch and hold [ADPTR])
Notification Vol	0 - 127	"Notification Tones" (page EN-150)
Audio Pairing	—	"Pairing the Digital Piano with a Bluetooth Audio Device" (page EN-152)
Pairing Clear	—	"Deleting Bluetooth Audio Device Pairing Registration" (page EN-153)
Audio C Cancel	Off, On	"Bluetooth Audio Center Cancel (Vocal Cut)" (page EN-158)
MIDI		—
Keyboard Ch	1 - 16	"Configuring MIDI Settings" (page EN-148)
Local Control	Off, On	
Hi-Reso MIDI Out	Off, On	
SYSTEM		—
Master Tuning	415.5 - 465.9	"Fine Tuning a Pitch (Master Tuning)" (page EN-130)
Op. Click Volume	0 - 10	"Setting the Volume of the Sound Made When the Touch Ring is Used (Operation Click Volume)" (page EN-26)
Panel Light	Off, 5, 30, 60, 120	"Panel Lights Off" (page EN-18)
Operation Lock	Off, On, Auto	"Operation Lock" (page EN-22)
Speaker Out	Off, On, Auto	"Outputting From the Speakers While Headphones are Connected" (page EN-20)
Headphone Mode	Off, On	"Headphone Mode" (page EN-20)
Auto Resume	Off, On	"Auto Resume" (page EN-17)
Auto Power Off	Off, On	"Auto Power Off" (page EN-17)
Power On Alert	Off, On	"Power On Alert" (page EN-18)
Battery Type	Alkaline, Ni-MH	"To select the Battery Type" (page EN-14)
Close-up	Off, On	"Close-Up Screen" (page EN-29)
LCD Contrast	1 - 17	"Adjusting Display Contrast" (page EN-19)

Menu Item	Setting Values	Reference
Touch Btn Sense	-1, 0, +1	"Setting the Sensitivity of the Touch Buttons and Touch Ring" (page EN-26)
Touch Ring Sense	-3 - 0 - +3	"Setting the Sensitivity of the Touch Buttons and Touch Ring" (page EN-26)
Setting Reset	—	"To return all Digital Piano settings to their initial factory defaults (Setting Reset)" (page EN-165)
Factory Reset	—	"To return all Digital Piano settings and data to their initial factory defaults (Factory Reset)" (page EN-165)
Version*4	—	—

*1 For a list of options, see the "Reference" listed to the right of each item.

*2 See "[Microphone Effect Type List](#)" (page EN-226).

*3 See "[List of Effects in the Microphone Effects Module](#)" (page EN-227).

*4 The software version of the device is displayed.

*5 See "[Preset DSP List](#)" (page EN-184)

*6 See "[List of Effects in the DSP Modules](#)" (page EN-187)

DSP List

Preset DSP List

Listed below are the types of DSP and the effects contained in each module from M1 to M4 for each type.

For more information on the effects listed in the M1 to M4 columns, see “[List of Effects in the DSP Modules](#)” (page EN-187).

No.	Preset DSP Name (Display)	M1	M2	M3	M4
1	Mono 1BandEQ	Mono 1-Band EQ			
2	Mono 2BandEQ	Mono 2-Band EQ			
3	Mono 3BandEQ	Mono 3-Band EQ			
4	Stereo1BndEQ	Stereo 1-Band EQ			
5	Stereo2BndEQ	Stereo 2-Band EQ			
6	Stereo3BndEQ	Stereo 3-Band EQ			
7	Tone Control	Tone Control			
8	Compressor	Compressor			
9	Limiter	Limiter			
10	Enhancer	Enhancer			
11	Phaser	Phaser			
12	Chorus	Chorus			
13	Flanger	Flanger			
14	Tremolo	Tremolo			
15	Auto Pan	Auto Pan			
16	Rotary	Rotary			
17	Drive Rotary	Drive Rotary			
18	LFO Wah	LFO Wah			
19	Auto Wah	Auto Wah			
20	Modeling Wah	Modeling Wah			
21	Pitch	PitchShifter			
22	Ring Mod	Ring Modulator			
23	Piano Effect	Piano Effect			
24	Distortion	Distortion			
25	Drive	Drive	Tone Control		
26	Mono IR	Mono IR			
27	Re-Amp 1	Compressor	Mono IR	Enhancer	Tone Control
28	Re-Amp 2	Compressor	Limiter	Mono IR	Delay
29	Re-Amp 3	Compressor	Limiter	Mono IR	Delay
30	Re-Amp 4	Compressor	Limiter	Amp Cab	Delay

No.	Preset DSP Name (Display)	M1	M2	M3	M4
31	Re-Amp 5	Distortion	Delay		
32	Drive Amp 1	Mono 3-Band EQ	Drive	Tone Control	Mono IR
33	Drive Amp 2	Drive	Tone Control	Mono IR	Tremolo
34	Drive Amp 3	Drive	Tone Control	Mono IR	AutoPan
35	Drive Amp 4	Drive	Tone Control	Mono IR	Phaser
36	Drive Amp 5	Drive	Tone Control	Mono IR	Flanger
37	Drive Amp 6	Drive	Tone Control	Mono IR	PitchShifter
38	OctaveDrvAmp	PitchShifter	Drive	Tone Control	Mono IR
39	PhaseDrvAmp	Phaser	Drive	Tone Control	Mono IR
40	DelayDrvAmp	Drive	Tone Control	Mono IR	Delay
41	Comp Amp 1	Compressoor	Drive	Mono 1-Band EQ	Mono IR
42	Comp Amp 2	Drive	Compressoor	Mono 1-Band EQ	Mono IR
43	Deley OD Amp	Drive	Enhancer	Mono IR	Delay
44	Wah Drv Amp	Modeling Wah	Drive	Mono IR	
45	DelayWahAmp	LFO Wah	Drive	Mono IR	Delay
46	Auto Wah Amp	Auto Wah	Drive	Mono IR	Delay
47	DriveAmpMod1	Drive	Mono IR	Phaser	Flanger
48	DriveAmpMod2	LFO Wah	Drive	Mono IR	Tremolo
49	S/H DriveAmp	LFO Wah	Drive	Mono IR	Auto Pan
50	PhaseDrvAmp2	Drive	Mono IR	Phaser	Delay
51	FlngrDelyAmp	Drive	Mono IR	Flanger	Delay
52	PitchModAmp	Drive	Mono IR	PitchShifter	Delay
53	Drive Rotary	Drive	Rotary		
54	DrvRotaryEQ	Drive Rotary	Stereo 3-Band EQ		
55	DrvRotaryPan	Drive Rotary	Auto Pan		
56	PhaserAmpPan	Drive	Mono IR	Phaser	Auto Pan
57	FlangrAmpPan	Drive	Mono IR	Flanger	Auto Pan
58	ReflectAmpPan	Drive	Mono IR	Reflection	Auto Pan
59	DualDriveAmp	Drive	Drive	Mono IR	
60	DualDrvAmpDI	Drive	Drive	Mono IR	Delay
61	BassAmpAmbi	Tone Control	Compressor	Mono IR	Delay
62	Comp Ambi 1	Tone Control	Compressor	Enhancer	Reflection
63	Comp Ambi 2	Tone Control	Compressor	Mono IR	Delay
64	Comp Ambi 3	Drive	Compressor	Mono IR	Delay
65	Comp Ambi 4	Drive	Compressor	Mono IR	Delay
66	EnhanceAmbi1	Drive	Enhancer	Mono IR	Delay

No.	Preset DSP Name (Display)	M1	M2	M3	M4
67	EnhanceAmbi2	Drive	Reflection	Mono IR	Delay
68	Comp Mod 1	Tone Control	Compressor	Tremolo	Tone Control
69	Comp Mod 2	Tone Control	Compressor	Phaser	Reflection
70	Comp Mod 3	Compressor	Flanger	Phaser	
71	Comp Mod 4	Compressor	Tremolo	Flanger	Delay
72	VibraTremolo	Mono IR	Mono 3-Band EQ	Vibraphone Tremolo	Reflection
73	EQ Mod 1	Tone Control	Tone Control	Phaser	Mono IR
74	EQ Mod 2	Tone Control	Flanger	Tone Control	Delay
75	EQ Mod 3	Tone Control	Chorus	Tone Control	Delay
76	EQ Mod 4	Tone Control	Tremolo	Chorus	Delay
77	Double Phase	Mono IR	Phaser	Phaser	Enhancer
78	DoubleFlang1	Mono IR	Flanger	Flanger	Tone Control
79	DoubleFlang2	Mono IR	Flanger	Flanger	Phaser
80	Tremolo Spin	Tremolo	Drive Rotary	Tone Control	
81	AmbientEnh 1	Enhancer	Reflection	Delay	Tone Control
82	AmbientEnh 2	Tone Control	Enhancer	Reflection	Delay
83	AmbientEnh 3	Tone Control	Drive	Mono IR	Delay
84	AmbientEnh 4	Piano Effect	Delay	Tone Control	
85	AmbientEnh 5	Enhancer	Delay	Tone Control	
86	AmbientEnh 6	Drive	Delay	Tone Control	
87	Pitch Delay	Delay	Pitch	Phaser	Auto Pan
88	ReflectDelay	Reflection	Enhancer	Auto Pan	Delay
89	Drive Delay	Drive	Delay	Tone Control	
90	Pitch Mod 1	Tone Control	Phaser	Delay	Pitch
91	Pitch Mod 2	Pitch	Delay	Phaser	Tone Control
92	Double Enhan	Mono IR	Enhancer	Enhancer	
93	Drive Enhan	Drive	Enhancer	Enhancer	
94	Reflection 1	Reflection	Delay	Tone Control	
95	Reflection 2	Delay	Reflection	Enhancer	Tone Control
96	Mod Tremolo	Phaser	Chorus	Flanger	Tremolo
97	Wah Phase	LFO Wah	Phaser	Delay	Tone Control
98	Wah Flanger	Flanger	Flanger	LFO Wah	Tone Control
99	Lo Cut EQ	Tone Control	Tone Control	Tone Control	
100	Stereo IR+EQ	Reflect	Stereo IR	Stereo 3-Band EQ	

List of Effects in the DSP Modules

Listed below are all the effects included in the DSP modules.

For details on the parameters and setting ranges that can be set for each effect, see “[Parameter List of DSP Module Effects](#)” (page EN-189).

Module Number	Display	DSP Module Name	Description
①	Mono 1BandEQ	Mono 1-Band EQ	This is a single-band monaural equalizer.
②	Mono 2BandEQ	Mono 2-Band EQ	This is a dual-band monaural equalizer.
③	Mono 3BandEQ	Mono 3-Band EQ	This is a three-band monaural equalizer.
④	Streo1BandEQ	Stereo 1-Band EQ	This is a single-band stereo equalizer.
⑤	Streo2BandEQ	Stereo 2-Band EQ	This is a dual-band stereo equalizer.
⑥	Streo3BandEQ	Stereo 3-Band EQ	This is a three-band stereo equalizer.
⑦	Tone Control	Tone Control	Monaural tone control that adjusts low, mid, and high frequencies.
⑧	Tremolo	Tremolo	Uses an LFO to shift the volume of the input signal.
⑨	Auto Pan	Auto Pan	Uses an LFO to shift the phase of the input signal.
⑩	Compressor	Compressor	Compresses the input signal and suppresses level variation.
⑪	Limiter	Limiter	Limits the input signal level so it does not rise above a preset level.
⑫	Enhancer	Enhancer	Enhances the profiles of the low range and high range of the input signal.
⑬	Phaser	Phaser	Produces a distinctive pulsating, broad sound by using an LFO to change the phase of the input signal and then mixes it with the original input signal.
⑭	Chorus	Chorus	Gives notes depth and breadth.
⑮	Flanger	Flanger	Applies wildly pulsating and metallic reverberation to notes. Enables selection of the LFO waveform.
⑯	Rotary	Rotary	This effect is a rotary speaker simulator.
⑰	DriveRotary	Drive Rotary	A rotary speaker simulator that makes overdrive possible.
⑱	Pitch	PitchShifter	This effect transforms the pitch of the input signal.
⑲	Ring Mod	Ring Modulator	Multiplies the input signal with an internal oscillator signal to create a metallic sound.
⑳	Reflection	Reflection	An effect that simulates the initial reflection of reverberation. Applies acoustic ambiance and presence to notes.
㉑	Delay	Delay	Delays the input signal and feeds it back to create a repeating effect.
㉒	Piano Effect	Piano Effect	An effect suited to acoustic piano play.
㉓	LFO Wah	LFO Wah	“Wah” effect that can automatically affect the frequency using an LFO.

Module Number	Display	DSP Module Name	Description
②4	Auto Wah	Auto Wah	“Wah” effect that can automatically shift the frequency according to the input signal level.
②5	Modeling Wah	Modeling Wah	Simulates various types of wah pedals. An effect that can automatically shift the frequency according to the level of the input signal.
②6	Distortion	Distortion	Distortion, wah, and amp simulator combined into a single effect.
②7	Drive	Drive	Simulates the drive of a musical instrument amplifier.
②8	Amp Cab	Amp Cab	Simulates an amp without distortion-generating drive and speaker cabinet.
②9	VibraTremolo	Vibraphone Tremolo	An effect that simulates the tremolo effect of vibraphone.
③0	Mono IR	Mono IR	Simulates the acoustic characteristics by monaural IR (Impulse Response) data.
③1	Stereo IR	Stereo IR	Simulates the acoustic characteristics by stereo IR (Impulse Response) data.

Parameter List of DSP Module Effects

Effect		Description	Settings
Display	Parameter Name		
① Mono 1-Band EQ		This is a single-band monaural equalizer.	
EQ Freq	EQ Frequency	Adjusts the center frequency of Equalizer.	*1 (page EN-201)
EQ Gain	EQ Gain	Adjusts the gain of Equalizer.	-12 - 00 - 12
Input Level	Input Level	Adjusts the input level.	000 - 127
Wet Level	Wet Level	Adjusts the level of the effect sound.	000 - 127
Dry Level	Dry Level	Adjusts the level of the direct sound.	000 - 127
② Mono 2-Band EQ		This is a dual-band monaural equalizer.	
EQ1 Freq	EQ1 Frequency	Adjusts the center frequency of Equalizer 1.	*1 (page EN-201)
EQ1 Gain	EQ1 Gain	Adjusts the gain of Equalizer 1.	-12 - 00 - 12
EQ2 Freq	EQ2 Frequency	Adjusts the center frequency of Equalizer 2.	*1 (page EN-201)
EQ2 Gain	EQ2 Gain	Adjusts the gain of Equalizer 2.	-12 - 00 - 12
Input Level	Input Level	Adjusts the input level.	000 - 127
Wet Level	Wet Level	Adjusts the level of the effect sound.	000 - 127
Dry Level	Dry Level	Adjusts the level of the direct sound.	000 - 127
③ Mono 3-Band EQ		This is a three-band monaural equalizer.	
EQ1 Freq	EQ1 Frequency	Adjusts the center frequency of Equalizer 1.	*1 (page EN-201)
EQ1 Gain	EQ1 Gain	Adjusts the gain of Equalizer 1.	-12 - 00 - 12
EQ2 Freq	EQ2 Frequency	Adjusts the center frequency of Equalizer 2.	*1 (page EN-201)
EQ2 Gain	EQ2 Gain	Adjusts the gain of Equalizer 2.	-12 - 00 - 12
EQ3 Freq	EQ3 Frequency	Adjusts the center frequency of Equalizer 3.	*1 (page EN-201)
EQ3 Gain	EQ3 Gain	Adjusts the gain of Equalizer 3.	-12 - 00 - 12
Input Level	Input Level	Adjusts the input level.	000 - 127
Wet Level	Wet Level	Adjusts the level of the effect sound.	000 - 127
Dry Level	Dry Level	Adjusts the level of the direct sound.	000 - 127

Effect		Description	Settings
Display	Parameter Name		
④ Stereo 1-Band EQ		This is a single-band stereo equalizer.	
EQ Freq	EQ Frequency	Adjusts the center frequency of Equalizer.	*1 (page EN-201)
EQ Gain	EQ Gain	Adjusts the gain of Equalizer.	-12 - 00 - 12
Input Level	Input Level	Adjusts the input level.	000 - 127
Wet Level	Wet Level	Adjusts the level of the effect sound.	000 - 127
Dry Level	Dry Level	Adjusts the level of the direct sound.	000 - 127
⑤ Stereo 2-Band EQ		This is a dual-band stereo equalizer.	
EQ1 Freq	EQ1 Frequency	Adjusts the center frequency of Equalizer 1.	*1 (page EN-201)
EQ1 Gain	EQ1 Gain	Adjusts the gain of Equalizer 1.	-12 - 00 - 12
EQ2 Freq	EQ2 Frequency	Adjusts the center frequency of Equalizer 2.	*1 (page EN-201)
EQ2 Gain	EQ2 Gain	Adjusts the gain of Equalizer 2.	-12 - 00 - 12
Input Level	Input Level	Adjusts the input level.	000 - 127
Wet Level	Wet Level	Adjusts the level of the effect sound.	000 - 127
Dry Level	Dry Level	Adjusts the level of the direct sound.	000 - 127
⑥ Stereo 3-Band EQ		This is a three-band stereo equalizer.	
EQ1 Freq	EQ1 Frequency	Adjusts the center frequency of Equalizer 1.	*1 (page EN-201)
EQ1 Gain	EQ1 Gain	Adjusts the gain of Equalizer 1.	-12 - 00 - 12
EQ2 Freq	EQ2 Frequency	Adjusts the center frequency of Equalizer 2.	*1 (page EN-201)
EQ2 Gain	EQ2 Gain	Adjusts the gain of Equalizer 2.	-12 - 00 - 12
EQ3 Freq	EQ3 Frequency	Adjusts the center frequency of Equalizer 3.	*1 (page EN-201)
EQ3 Gain	EQ3 Gain	Adjusts the gain of Equalizer 3.	-12 - 00 - 12
Input Level	Input Level	Adjusts the input level.	000 - 127
Wet Level	Wet Level	Adjusts the level of the effect sound.	000 - 127
Dry Level	Dry Level	Adjusts the level of the direct sound.	000 - 127

Effect		Description	Settings
Display	Parameter Name		
⑦ Tone Control		Monaural tone control that adjusts low, mid, and high frequencies.	
Low Freq	Low Frequency	Adjusts the cutoff frequency of Low-range	*2 (page EN-201)
Low Gain	Low Gain	Adjusts the Low-range gain.	-12 - 00 - 12
Mid Freq	Mid Frequency	Adjusts the center frequency of Mid-range.	*1 (page EN-201)
Mid Gain	Mid Gain	Adjusts the Mid-range gain.	-12 - 00 - 12
High Freq	High Frequency	Adjusts the cutoff frequency of High-range	*3 (page EN-201)
High Gain	High Gain	Adjusts the High-range gain.	-12 - 00 - 12
Input Level	Input Level	Adjusts the input level.	000 - 127
Wet Level	Wet Level	Adjusts the level of the effect sound.	000 - 127
Dry Level	Dry Level	Adjusts the level of the direct sound.	000 - 127
⑧ Tremolo		Uses an LFO to shift the volume of the input signal.	
Rate	LFO Rate	Adjusts the LFO rate.	000 - 127
Depth	LFO Depth	Adjusts the LFO depth.	000 - 127
Waveform	LFO Waveform	Selects the LFO waveform.	Sine, Triangle, Trapzoid
Wet Level	Wet Level	Adjusts the level of the effect sound.	000 - 127
Dry Level	Dry Level	Adjusts the level of the direct sound.	000 - 127
⑨ Auto Pan		Uses an LFO to shift the phase of the input signal.	
Rate	LFO Rate	Adjusts the LFO rate.	000 - 127
Depth	LFO Depth	Adjusts the LFO depth.	000 - 127
Waveform	LFO Waveform	Selects the LFO waveform.	Sine, Triangle, Trapzoid, Trapzoid 1, Trapzoid 2, Trapzoid 3, Trapzoid 4
Manual	Manual	Adjusts the pan (stereo position). -64 is full left, 0 is center, and +63 is full right.	-64 - 00 - 63
Wet Level	Wet Level	Adjusts the level of the effect sound.	000 - 127
Dry Level	Dry Level	Adjusts the level of the direct sound.	000 - 127

Effect		Description	Settings
Display	Parameter Name		
⑩ Compressor		Compresses the input signal and suppresses level variation.	
Attack	Attack	Adjusts the time until compression goes into effect. A smaller value causes prompt compressor operation, which suppresses the attack of the input signal. A larger value delays compressor operation, which causes the attack of the input signal to be output as-is.	000 - 127
Release	Release	Adjusts the time until compression is released after the input signal drops below a prescribed level. When an attack feeling is desired (no compression at the onset of the sound), set this parameter to as low a value as possible. To have compression applied at all times, set a high value.	000 - 127
Ratio	Ratio	Adjusts the compression ratio of the audio signal.	1:1, 2:1, 4:1, 8:1, 16:1, 32:1, Inf:1
Wet Level	Wet Level	Adjusts the level of the effect sound. Output volume changes in accordance with the Ratio setting and the characteristics of the input tone.	000 - 127
Dry Level	Dry Level	Adjusts the level of the direct sound.	000 - 127
⑪ Limiter		Limits the input signal level so it does not rise above a preset level.	
Limit	Limit	Adjusts the volume level of the limit at which limiting is applied.	000 - 127
Attack	Attack	Adjusts the time until the compression effect starts. A smaller value causes prompt limiter operation, which suppresses the attack of the input signal. A larger value delays limiter operation, which causes the attack of the input signal to be output as-is.	000 - 127
Release	Release	Adjusts the time until compression is released after the input signal drops below a prescribed level.	000 - 127
Wet Level	Wet Level	Adjusts the level of the effect sound. Output volume changes in accordance with the Limit setting and the characteristics of the input tone. Use this parameter to correct for such changes.	000 - 127
Dry Level	Dry Level	Adjusts the level of the direct sound.	000 - 127

Effect		Description	Settings
Display	Parameter Name		
⑫ Enhancer		Enhances the profiles of the low range and high range of the input signal.	
Low Freq	Low Frequency	Adjusts the low range enhancer frequency.	000 - 127
Low Gain	Low Gain	Adjusts the low range enhancer gain.	000 - 127
High Freq	High Frequency	Adjusts the high range enhancer frequency.	000 - 127
High Gain	High Gain	Adjusts the high range enhancer gain.	000 - 127
Input Level	Input Level	Adjusts the input level.	000 - 127
Wet Level	Wet Level	Adjusts the level of the effect sound.	000 - 127
Dry Level	Dry Level	Adjusts the level of the direct sound.	000 - 127
⑬ Phaser		Produces a distinctive pulsating, broad sound by using an LFO to change the phase of the input signal and then mixes it with the original input signal.	
Resonance	Resonance	Adjusts the strength of feedback.	000 - 127
Manual	Manual	Adjusts the reference phaser shift amount.	-64 - 00 - 63
Rate	LFO Rate	Adjusts the LFO rate.	000 - 127
Depth	LFO Depth	Adjusts the LFO depth.	000 - 127
Waveform	LFO Waveform	Selects the LFO waveform.	Sine, Triangle, Random
Input Level	Input Level	Adjusts the input level.	000 - 127
Wet Level	Wet Level	Adjusts the level of the effect sound.	000 - 127
Dry Level	Dry Level	Adjusts the level of the direct sound.	000 - 127
⑭ Chorus		Gives notes depth and breadth.	
Rate	LFO Rate	Adjusts the LFO rate.	000 - 127
Depth	LFO Depth	Adjusts the LFO depth.	000 - 127
Waveform	LFO Waveform	Selects the LFO waveform.	Sine, Triangle
Feedback	Feedback	Adjusts the strength of feedback	-64 - 00 - 63
Wet Level	Wet Level	Adjusts the level of the effect sound.	000 - 127
Polarity	Polarity	Inverts the LFO of one channel.	Negative, Positive
Input Level	Input Level	Adjusts the input level.	000 - 127
Dry Level	Dry Level	Adjusts the level of the direct sound.	000 - 127

Effect		Description	Settings
Display	Parameter Name		
⑮ Flanger		Applies wildly pulsating and metallic reverberation to notes. Enables selection of the LFO waveform.	
Rate	LFO Rate	Adjusts the LFO rate.	000 - 127
Depth	LFO Depth	Adjusts the LFO depth.	000 - 127
Waveform	LFO Waveform	Selects the LFO waveform.	Sine, Triangle, Random
Feedback	Feedback	Adjusts the strength of feedback	-64 - 00 - 63
Wet Level	Wet Level	Adjusts the level of the effect sound.	000 - 127
Input Level	Input Level	Adjusts the input level.	000 - 127
Dry Level	Dry Level	Adjusts the level of the direct sound.	000 - 127
⑯ Rotary		This effect is a rotary speaker simulator.	
Type	Type	Selects the rotary speaker type.	0 - 3
Speed	Speed	Switches the speed mode between fast and slow.	Slow, Fast
Brake	Brake	Stops speaker rotation.	Rotate, Stop
Fall Accel	Fall Accel	Adjusts acceleration when the speed mode is switched from fast to slow.	000 - 127
Rise Accel	Rise Accel	Adjusts acceleration when the speed mode is switched from slow to fast.	000 - 127
Slow Rate	Slow Rate	Adjusts the speaker rotation speed in the slow speed mode.	000 - 127
Fast Rate	Fast Rate	Adjusts the speaker rotation speed in the fast speed mode.	000 - 127
Vib/Cho	Vibrato/Chorus	Selects the vibrato and the chorus type.	Off, Vibrato1, Chorus 1, Vibrato2, Chorus 2, Vibrato3, Chorus 3
Wet Level	Wet Level	Adjusts the level of the effect sound.	000 - 127
Dry Level	Dry Level	Adjusts the level of the direct sound.	000 - 127

Effect		Description	Settings
Display	Parameter Name		
⑰ Drive Rotary		A rotary speaker simulator that makes overdrive possible.	
Type	Type	Selects the rotary speaker type.	0 - 3
OD Gain	Overdrive Gain	Adjusts overdrive gain.	000 - 127
OD Level	Overdrive Level	Adjusts the overdrive output level.	000 - 127
Speed	Speed	Switches the speed mode between fast and slow.	Slow, Fast
Brake	Brake	Stops speaker rotation.	Rotate, Stop
Fall Accel	Fall Accel	Adjusts acceleration when the speed mode is switched from fast to slow.	000 - 127
Rise Accel	Rise Accel	Adjusts acceleration when the speed mode is switched from slow to fast.	000 - 127
Slow Rate	Slow Rate	Adjusts the speaker rotation speed in the slow speed mode.	000 - 127
Fast Rate	Fast Rate	Adjusts the speaker rotation speed in the fast speed mode.	000 - 127
Vib/Cho	Vibrato/Chorus	Selects the vibrato and the chorus type.	Off, Vibrato1, Chorus 1, Vibrato2, Chorus 2, Vibrato3, Chorus 3
Wet Level	Wet Level	Adjusts the level of the effect sound.	000 - 127
Dry Level	Dry Level	Adjusts the level of the direct sound.	000 - 127
⑱ PitchShifter		This effect transforms the pitch of the input signal.	
PitchQuarter	Pitch	Adjusts the pitch shift amount in quarter tone steps.	-24 - 00 - 24
High Damp	High Damp	Adjusts the high-range damp. A smaller number increases damping.	000 - 127
Feedback	Feedback	Adjusts the feedback amount.	000 - 127
Input Level	Input Level	Adjusts the input level.	000 - 127
Wet Level	Wet Level	Adjusts the level of the effect sound.	000 - 127
Dry Level	Dry Level	Adjusts the level of the direct sound.	000 - 127
Pitch Fine	Fine	Adjusts the pitch shift amount. -50 is a quarter note decrease, while +50 is a quarter note increase.	-50 - 00 - 50

Effect		Description	Settings
Display	Parameter Name		
⑲ Ring Modulator		Multiplies the input signal with an internal oscillator signal to create a metallic sound.	
OSC Freq	OSC Frequency	Sets the reference frequency of the internal oscillator.	000 - 127
Rate	LFO Rate	Adjusts the LFO rate.	000 - 127
Depth	LFO Depth	Adjusts the LFO depth.	000 - 127
Tone	Tone	Adjusts the timbre of the ring modulator input sound.	000 - 127
Wet Level	Wet Level	Adjusts the level of the effect sound.	000 - 127
Dry Level	Dry Level	Adjusts the level of the direct sound.	000 - 127
⑳ Reflection		An effect that simulates the initial reflection of reverberation. Applies acoustic ambiance and presence to notes.	
Wet Level	Wet Level	Adjusts the level of the effect sound.	000 - 127
Feedback	Feedback	Adjusts the repeat of the reflected sound.	000 - 127
Tone	Tone	Adjusts the tone of the reflected sound.	000 - 127
Input Level	Input Level	Adjusts the input level.	000 - 127
Dry Level	Dry Level	Adjusts the level of the direct sound.	000 - 127
㉑ Delay		Delays the input signal and feeds it back to create a repeating effect.	
Time	Delay Time	Adjusts the total delay time in 1 ms units.	0001 - 1099
L.Time Ratio	Delay Ratio L	Adjusts the ratio of the left channel relative to the total delay time.	000 - 127
R.Time Ratio	Delay Ratio R	Adjusts the ratio of the right channel relative to the total delay time.	000 - 127
L.Level	Delay Level L	Adjusts the level of the left channel.	000 - 127
R.Level	Delay Level R	Adjusts the level of the right channel.	000 - 127
FeedbackType	Feedback Type	Selects the feedback type. Stereo: Stereo feedback Cross: Cross feedback	Stereo, Cross
Feedback Lvl	Feedback	Adjusts the feedback amount.	000 - 127
High Damp	High Damp	Adjusts the high-range damp. A smaller number increases damping.	000 - 127
Tmpo Sync	Delay Tempo Sync	Specifies how the actual total delay time is synced with tempo. Off: Uses Delay Time value. 1/4 to 1: Uses value in accordance with number of beats.	Off, 1/4, 1/3, 3/8, 1/2, 2/3, 3/4, 1

Effect		Description	Settings
Display	Parameter Name		
Input Level	Input Level	Adjusts the input level.	000 - 127
Dry Level	Dry Level	Adjusts the level of the direct sound.	000 - 127
Wet Level	Wet Level	Adjusts the level of the effect sound.	000 - 127
②② Piano Effect		An effect suited to acoustic piano play.	
Lid Type	Lid Type	Adjusts how sound resonates in accordance with the opening state of a piano lid.	Closed, SemiOpen, FullOpen
ReflectLevel	Reflection Level	Adjusts the level of the initial reflection.	000 - 127
Input Level	Input Level	Adjusts the input level.	000 - 127
Wet Level	Wet Level	Adjusts the level of the effect sound.	000 - 127
Dry Level	Dry Level	Adjusts the level of the direct sound.	000 - 127
②③ LFO Wah		"Wah" effect that can automatically affect the frequency using an LFO.	
Input Level	Input Level	Adjusts the input level. The input signal can become distorted when the level of the sound being input, the number of chords, or the Resonance value is large. Adjust this parameter to eliminate such distortion.	000 - 127
Resonance	Resonance	Adjusts the strength of feedback	000 - 127
Manual	Manual	Adjusts the wah filter reference frequency.	000 - 127
Rate	LFO Rate	Adjusts the LFO rate.	000 - 127
Depth	LFO Depth	Adjusts the LFO depth.	000 - 127
Waveform	LFO Waveform	Selects the LFO waveform.	Sine, Triangle, Random
Wet Level	Wet Level	Adjusts the level of the effect sound.	000 - 127
Dry Level	Dry Level	Adjusts the level of the direct sound.	000 - 127

Effect		Description	Settings
Display	Parameter Name		
②4 Auto Wah		“Wah” effect that can automatically shift the frequency according to the input signal level.	
Input Level	Input Level	Adjusts the input level. The input signal can become distorted when the level of the sound being input, the number of chords, or the Resonance value is large. Adjust this parameter to eliminate such distortion.	000 - 127
Resonance	Resonance	Adjusts the strength of feedback	000 - 127
Manual	Manual	Adjusts the wah filter reference frequency.	000 - 127
Depth	Depth	Adjusts the depth of the wah in accordance with the level of the input signal. Setting a positive value causes the wah filter to open in direct proportion with the size of the input signal, producing a bright sound. Setting a negative value causes the wah filter to close in direct proportion with the size of the input signal, producing a dark sound.	-64 - 00 - 63
Wet Level	Wet Level	Adjusts the level of the effect sound.	000 - 127
Dry Level	Dry Level	Adjusts the level of the direct sound.	000 - 127
②5 Modeling Wah		Simulates various types of wah pedals. An effect that can automatically shift the frequency according to the level of the input signal.	
Output Level	Level	Adjusts the wah level.	000 - 127
Type	Type	Selects the wah type.	CAE, CRY, IBZ, VO, FAT, LIGHT, 7STR, RESO
Manual	Manual	Adjusts the wah filter reference frequency.	000 - 127
Depth	Depth	Adjusts the depth of the wah in accordance with the level of the input signal. Setting a positive value causes the wah filter to open in direct proportion with the size of the input signal, producing a bright sound. Setting a negative value causes the wah filter to close in direct proportion with the size of the input signal, producing a dark sound.	-64 - 00 - 63
Wet Level	Wet Level	Adjusts the level of the effect sound.	000 - 127
Dry Level	Dry Level	Adjusts the level of the direct sound.	000 - 127

Effect		Description	Settings
Display	Parameter Name		
Ⓔ Distortion		Distortion, wah, and amp simulator combined into a single effect.	
Dist Gain	Dist Gain	Adjusts the distortion input signal gain.	000 - 127
Dist Level	Dist Level	Adjusts the distortion output level.	000 - 127
Dist Low	Dist Low	Adjusts the distortion low-range gain.	000 - 127
Dist High	Dist High	Adjusts the distortion high-range gain.	000 - 127
Wah Type	Wah Type	Specifies the wah type.	LPF, C-Wah, V-Wah, F-Wah, L-Wah, H-Wah
Wah Depth	Wah Depth	Adjusts the depth of the wah in accordance with the level of the input signal.	-64 - 00 - 63
Wah Manual	Wah Manual	Adjusts the wah filter reference frequency.	000 - 127
Routing	Routing	Specifies the distortion and wah connection.	Dist, Wah, Wah-Dist, Dist-Wah
Amp Type	Amp	Specifies the amp type.	Bypass, FD-PRNST, FD-TWRV1, RL-J12, FD-TWD, FD-DXRV, VX-AC3, ML-DC3, MB-MK1, MS-STK, FD-TWRV2, SL-SLO, MB-RCTF, PV-51-SK, BASS-CMB, FD-BMAN, BASS-STK
Wet Level	Wet Level	Adjusts the level of the effect sound.	000 - 127
Dry Level	Dry Level	Adjusts the level of the direct sound.	000 - 127

Effect		Description	Settings
Display	Parameter Name		
⑳ Drive		Simulates the drive of a musical instrument amplifier.	
Type	Drive Type	Selects the drive type.*4	(page EN-201)
Gain	Gain	Adjusts the driver input signal gain.	000 - 127
Output Level	Level	Adjusts the drive output level.	000 - 127
Wet Level	Wet Level	Adjusts the level of the effect sound.	000 - 127
Dry Level	Dry Level	Adjusts the level of the direct sound.	000 - 127
㉑ Amp Cab		Simulates an amp without distortion-generating drive and speaker cabinet.	
Type	Type	Selects the amp cabinet type.	(page EN-202)
Variation	Variation	Selects a variation that changes the setup of the currently selected amp. The number of variations (page EN-202) depends on the amp type.	1 - 4
Wet Level	Wet Level	Adjusts the level of the effect sound.	000 - 127
Dry Level	Dry Level	Adjusts the level of the direct sound.	000 - 127
㉒ Vibraphone Tremolo		An effect that simulates the tremolo effect of vibraphone.	
Rate	LFO Rate	Adjusts the LFO rate.	000 - 127
Depth	LFO Depth	Adjusts the LFO depth.	000 - 127
Input Level	Input Level	Adjusts the input level.	000 - 127
Wet Level	Wet Level	Adjusts the level of the effect sound.	000 - 127
Dry Level	Dry Level	Adjusts the level of the direct sound.	000 - 127
㉓ Mono IR		Simulates the acoustic characteristics by monaural IR (Impulse Response) data.	
Categ	Category	Selects the IR data category.*5	*7
Type	Type	Selects the IR data type.*6	*8
Wet Level	Wet Level	Adjusts the level of the effect sound.	000 - 127
Dry Level	Dry Level	Adjusts the level of the direct sound.	000 - 127

Effect		Description	Settings
Display	Parameter Name		
③ Stereo IR		Simulates the acoustic characteristics by stereo IR (Impulse Response) data.	
L.Category	Left Category	Selects the IR data category of the left channel.*5	*7
L.Type	Left Type	Selects the IR data type of the left channel.*6	*8
R.Category	Right Category	Selects the IR data category of the right channel.*5	*7
R.Type	Right Type	Selects the IR data type of the right channel.*6	*8
Wet Level	Wet Level	Adjusts the level of the effect sound.	000 - 127
Dry Level	Dry Level	Adjusts the level of the direct sound.	000 - 127

*1 100Hz, 125Hz, 160Hz, 200Hz, 250Hz, 315Hz, 400Hz, 500Hz, 630Hz, 800Hz, 1.0kHz, 1.3kHz, 1.6kHz, 2.0kHz, 2.5kHz, 3.2kHz, 4.0kHz, 5.0kHz, 6.3kHz, 8.0kHz

*2 50Hz, 63Hz, 80Hz, 100Hz, 125Hz, 160Hz, 200Hz, 250Hz, 315Hz, 400Hz, 500Hz, 630Hz, 800Hz

*3 2.0kHz, 2.5kHz, 3.2kHz, 4.0kHz, 5.0kHz, 6.0kHz, 8.0kHz, 10kHz, 13kHz, 16kHz

*4

Drive Type	Display	Description
Clean1 - 4	Clean1 - 4	Simulates a clean sound with little distortion.
Crunch1 - 4	Crunch1 - 4	Simulates a crisp crunch sound with little distortion.
Overdrive1 - 4	Overdrv1 - 4	Simulates an overdrive sound with mellow distortion.
Distortion1 - 4	Distort1 - 4	Simulates a hard, straight distortion sound.
Metal1 - 4	Metal1 - 4	Simulates an extreme and weighty distortion sound that is suitable for heavy metal music.

*5 Refer to the "Category" column of "IR Type List" (page EN-204).

*6 Refer to the "Type" column of "IR Type List" (page EN-204).

*7 26 categories in all.

*8 The number of types differs from categories (1 to 121 types).

Amp Cab Type List

Display	Number of variations	Display	Number of variations
FD-PRNST	1	FD-TWRV3	3
FD-TWRV1	1	FU-OD	2
RL-J12	1	GB-LANC	2
FD-TWD	1	HK-TM18	3
FD-DXRV	1	HK-SBL	3
VX-AC3	1	KH-STDT	2
ML-DC3	1	KR-RV	3
MB-MK1	1	LY-IRST	4
MS-STK	1	MB-MK3	3
FD-TWRV2	1	MB-F3+DI	3
SL-SLO	1	MB-D5	1
MB-RCTF	1	MB-DRCT	4
PV-51-SK	1	MB-TX+.5	1
BASS-CMB	1	MB-TX+DI	4
FD-BMAN	1	MS-VS80	4
BASS-STK	1	MS-J800	4
65-MQ	3	MS-J2401	2
AD-MP+CA	3	MS-J2000	3
BC-HC30	2	MS-J2+MB	2
BN-SHV	3	MS-PLX	3
BN-ECS	3	MS-J1+DI	2
BN-UBR	3	MT-CFT	4
CV-LG3	3	OR-O15	4
DR-MZ38	2	PN-P7	2
DZ-V4	2	PR-SE3	3
DZ-HA	2	PV-51II	4
EG-TWK	4	PV-65MH	4
EG-VEN	3	RA-NBK	3
EN-G15	2	RL-J20	2
EN-INV	1	RL-J120	2
EN-BM	1	RV-30	2
EN-53+DI	2	SA-PS1	4
EV-51III	4	SL-X8	2
FD-CHMP	3	SL-X9	2
FD-TWN	3	SP-1624	3

Display	Number of variations
SP-1695	3
SU-BGR3	3
VH-SP6	2
VX-A15	3
VX-A15TB	2
VX-A30	3
VX-A30TB	3
YM-DG8	4
YM-F112	4
YM-F115	4
RD-PET-PRE	4
RD-PET-PRE-TRM	4
RD-MK1-PRE	4
RD-MK1-PRE-TRM	4
RD-MK2-PRE	4
RD-MK2-PRE-TRM	4
RD-DMY-PRE	4
RD-PRE-STWT	4
YM-CP-PRE	4
YM-CP-PRE-TRM	4
WR-200-PRE	4
CLV-TAB-PRE	4
CLV-CMB-PRE	4
LES-CMB-PRE	4
RL-VP-PRE	4
AC-360	2
AP-SV4DI	2
EB-C450	2
FD-BMNtw	2
FD-BMNsv	2
FD-BMNbk	2
FD-STBAS	2
GK-150	3
MK-T501	3
SW-PB20	3
SW-SM50	3

Display	Number of variations
RL-CBKB	1
LY-3C-AC	1
AC-SIM	4
AP-EXT-VIN	4
STR-EXT	4
MG-MIN-VCF-NEG	4
MG-MIN-VCF-POS	4
MG-MIN-VCF-TOP	3
MG-MIN-VCF-OVL	4
MG-MIN-VCF-OVL-T	4
SSL-LCUT	4
SSL-LMCUT	4
HI-BST	4
PARA-BST	4
BASFIL-DEP	4
BASFIL-SHL	4
EH-SS-SPRK	4

IR Type List

Category	Type
Guitar Amp 1	FD-PRNST
Guitar Amp 1	FD-TWNRV1
Guitar Amp 1	RL-J12
Guitar Amp 1	FD-TWD
Guitar Amp 1	FD-DXRV
Guitar Amp 1	VX-AC3
Guitar Amp 1	ML-DC3
Guitar Amp 1	MB-MK1
Guitar Amp 1	MS-J8
Guitar Amp 1	FD-TWNRV2
Guitar Amp 1	SL-SLO
Guitar Amp 1	MB-RCTF
Guitar Amp 1	PV-51-SK
Guitar Amp 1	65-MQ cl
Guitar Amp 1	65-MQ cr
Guitar Amp 1	65-MQ od
Guitar Amp 1	AD-MP+CAB cl
Guitar Amp 1	AD-MP+CAB ds
Guitar Amp 1	AD-MP+CAB mt
Guitar Amp 1	BC-HC30 cr
Guitar Amp 1	BC-HC30 od
Guitar Amp 1	BN-SHV cl
Guitar Amp 1	BN-SHV od
Guitar Amp 1	BN-SHV ds
Guitar Amp 1	BN-ECS od
Guitar Amp 1	BN-ECS ds
Guitar Amp 1	BN-ECS mt
Guitar Amp 1	BN-UBR cl
Guitar Amp 1	BN-UBR od
Guitar Amp 1	BN-UBR mt
Guitar Amp 1	CV-LG3 cr
Guitar Amp 1	CV-LG3 ds1
Guitar Amp 1	CV-LG3 ds2
Guitar Amp 1	DR-MZ38 cl
Guitar Amp 1	DR-MZ38 cr
Guitar Amp 1	DZ-V4 cr

Category	Type
Guitar Amp 1	DZ-V4 mt
Guitar Amp 1	DZ-HA ds1
Guitar Amp 1	DZ-HA ds2
Guitar Amp 1	EG-TWK cl
Guitar Amp 1	EG-TWK cr
Guitar Amp 1	EG-TWK od
Guitar Amp 1	EG-TWK ds
Guitar Amp 1	EG-VEN cl
Guitar Amp 1	EG-VEN cr
Guitar Amp 1	EG-VEN ds
Guitar Amp 1	EN-G15 cl
Guitar Amp 1	EN-G15 ds
Guitar Amp 1	EN-INV
Guitar Amp 1	EN-BM
Guitar Amp 1	EV-51III cl
Guitar Amp 1	EV-51III od
Guitar Amp 1	EV-51III ds
Guitar Amp 1	EV-51III mt
Guitar Amp 1	FD-CHMP cl
Guitar Amp 1	FD-CHMP cr
Guitar Amp 1	FD-CHMP od
Guitar Amp 1	FD-TWN cl
Guitar Amp 1	FD-TWN cr
Guitar Amp 1	FD-TWN od
Guitar Amp 1	FD-TWRV3 cl
Guitar Amp 1	FD-TWRV3 cr
Guitar Amp 1	FD-TWRV3 od
Guitar Amp 1	FU-OD cr
Guitar Amp 1	FU-OD od
Guitar Amp 1	GB-LANC cl
Guitar Amp 1	GB-LANC od
Guitar Amp 1	HK-TM18 cl
Guitar Amp 1	HK-TM18 cr
Guitar Amp 1	HK-TM18 od
Guitar Amp 1	HK-SBL ds1
Guitar Amp 1	HK-SBL ds2

Category	Type
Guitar Amp 1	HK-SBL ds3
Guitar Amp 1	KH-STDT cl
Guitar Amp 1	KH-STDT od
Guitar Amp 1	KR-RV ds
Guitar Amp 1	KR-RV mt1
Guitar Amp 1	KR-RV mt2
Guitar Amp 1	LY-IRST cl
Guitar Amp 1	LY-IRST cr
Guitar Amp 1	LY-IRST ds
Guitar Amp 1	LY-IRST mt
Guitar Amp 1	MB-MK3 cl
Guitar Amp 1	MB-MK3 od
Guitar Amp 1	MB-MK3 ds
Guitar Amp 1	MB-D5 ds
Guitar Amp 1	MB-DRCT ds
Guitar Amp 1	MB-DRCT mt1
Guitar Amp 1	MB-DRCT mt2
Guitar Amp 1	MB-DRCT mt3
Guitar Amp 1	MB-TX+.5 ds
Guitar Amp 1	MS-VS80 cl
Guitar Amp 1	MS-VS80 cr
Guitar Amp 1	MS-VS80 od
Guitar Amp 1	MS-VS80 ds
Guitar Amp 1	MS-J800 cl
Guitar Amp 1	MS-J800 cr
Guitar Amp 1	MS-J800 ds
Guitar Amp 1	MS-J800 f10
Guitar Amp 1	MS-J2401 od
Guitar Amp 1	MS-J2401 ds
Guitar Amp 1	MS-J2000 cl
Guitar Amp 1	MS-J2000 cr
Guitar Amp 1	MS-J2000 ds
Guitar Amp 1	MS-J2+MB ds
Guitar Amp 1	MS-J2+MB mt
Guitar Amp 1	MS-PLX cr
Guitar Amp 1	MS-PLX od
Guitar Amp 1	MS-PLX ds
Guitar Amp 1	MT-CFT cl1

Category	Type
Guitar Amp 1	MT-CFT cl2
Guitar Amp 1	MT-CFT cr
Guitar Amp 1	MT-CFT od
Guitar Amp 1	OR-O15 cl
Guitar Amp 1	OR-O15 cr
Guitar Amp 1	OR-O15 od
Guitar Amp 1	OR-O15 ds
Guitar Amp 1	PN-P7 cl
Guitar Amp 1	PN-P7 ds
Guitar Amp 1	PR-SE3 cl
Guitar Amp 1	PR-SE3 cr
Guitar Amp 1	PR-SE3 ds
Guitar Amp 2	PV-51II ds1
Guitar Amp 2	PV-51II ds2
Guitar Amp 2	PV-51II ds3
Guitar Amp 2	PV-51II ds4
Guitar Amp 2	PV-65MH cr
Guitar Amp 2	PV-65MH od
Guitar Amp 2	PV-65MH ds1
Guitar Amp 2	PV-65MH ds2
Guitar Amp 2	RA-NBK cl
Guitar Amp 2	RA-NBK cr
Guitar Amp 2	RA-NBK ds
Guitar Amp 2	RL-J20 cl
Guitar Amp 2	RL-J20 ds
Guitar Amp 2	RL-J120 cl
Guitar Amp 2	RL-J120 ds
Guitar Amp 2	RV-30 cl
Guitar Amp 2	RV-30 cr
Guitar Amp 2	SA-PS1 cl
Guitar Amp 2	SA-PS1 od
Guitar Amp 2	SA-PS1 ds
Guitar Amp 2	SA-PS1 mt
Guitar Amp 2	SL-X8 cl
Guitar Amp 2	SL-X8 cr
Guitar Amp 2	SL-X9 ds1
Guitar Amp 2	SL-X9 ds2
Guitar Amp 2	SP-1624 cl

Category	Type
Guitar Amp 2	SP-1624 cr
Guitar Amp 2	SP-1624 od
Guitar Amp 2	SP-1695 cl
Guitar Amp 2	SP-1695 cr
Guitar Amp 2	SP-1695 od
Guitar Amp 2	SU-BGR3 cl
Guitar Amp 2	SU-BGR3 od
Guitar Amp 2	SU-BGR3 ds
Guitar Amp 2	VH-SP6 cl
Guitar Amp 2	VH-SP6 od
Guitar Amp 2	VX-A15 cl
Guitar Amp 2	VX-A15 cr
Guitar Amp 2	VX-A15 od
Guitar Amp 2	VX-A15TB cl
Guitar Amp 2	VX-A15TB cr
Guitar Amp 2	VX-A30 cl
Guitar Amp 2	VX-A30 cr
Guitar Amp 2	VX-A30 od
Guitar Amp 2	VX-A30TB cl
Guitar Amp 2	VX-A30TB cr
Guitar Amp 2	VX-A30TB od
Guitar Amp 2	YM-DG8 cl
Guitar Amp 2	YM-DG8 cr
Guitar Amp 2	YM-DG8 od
Guitar Amp 2	YM-DG8 ds
Guitar Amp 2	YM-F112 cl
Guitar Amp 2	YM-F112 cl 87
Guitar Amp 2	YM-F112 cr
Guitar Amp 2	YM-F112 crD12
Guitar Amp 2	YM-F112 od
Guitar Amp 2	YM-F112 od 87
Guitar Amp 2	YM-F112a3
Guitar Amp 2	YM-F112a5
Guitar Amp 2	YM-F112a5 br
Guitar Amp 2	YM-F112a5 t-
Guitar Amp 2	YM-F112a5 b-
Guitar Amp 2	YM-F112a5 tb-
Guitar Amp 2	YM-F112a5 rv

Category	Type
Guitar Amp 2	YM-F112a5 fu
Guitar Amp 2	YM-F112a7
Guitar Amp 2	YM-F112aX
Guitar Amp 2	YM-F112aX fu
Guitar Amp 2	YM-F112A3
Guitar Amp 2	YM-F112A5
Guitar Amp 2	YM-F112A5 br
Guitar Amp 2	YM-F112A5 t-
Guitar Amp 2	YM-F112A5 b-
Guitar Amp 2	YM-F112A5 tb-
Guitar Amp 2	YM-F112A5 fu
Guitar Amp 2	YM-F112A5fubr
Guitar Amp 2	YM-F112A7
Guitar Amp 2	YM-F112AX
Guitar Amp 2	YM-F112AXfubr
Guitar Amp 2	YM-F112b35
Guitar Amp 2	YM-F112b3X
Guitar Amp 2	YM-F112b55
Guitar Amp 2	YM-F112b5X
Guitar Amp 2	YM-F112b5X br
Guitar Amp 2	YM-F112b5X t-
Guitar Amp 2	YM-F112b5X b-
Guitar Amp 2	YM-F112b5Xtb-
Guitar Amp 2	YM-F112b5X rv
Guitar Amp 2	YM-F112b5X fu
Guitar Amp 2	YM-F112b75
Guitar Amp 2	YM-F112b7X
Guitar Amp 2	YM-F112bX3tb-
Guitar Amp 2	YM-F112bX5
Guitar Amp 2	YM-F112bXX
Guitar Amp 2	YM-F112bXX fu
Guitar Amp 2	YM-F112bXXfub
Guitar Amp 2	YM-F112B3X
Guitar Amp 2	YM-F112B5X
Guitar Amp 2	YM-F112B5X br
Guitar Amp 2	YM-F112B5X t-
Guitar Amp 2	YM-F112B5X b-
Guitar Amp 2	YM-F112B5Xtb-

Category	Type
Guitar Amp 2	YM-F112B5X rv
Guitar Amp 2	YM-F112B7X
Guitar Amp 2	YM-F112BXX
Guitar Amp 2	YM-F112BXXfub
Guitar Amp 2	YM-F115 cl
Guitar Amp 2	YM-F115 clD12
Guitar Amp 2	YM-F115 cr
Guitar Amp 2	YM-F115 cr 87
Guitar Amp 2	YM-F115 od
Guitar Amp 2	YM-F115 odD12
Guitar Amp 3	FRMS-M06dps L
Guitar Amp 3	FRMS-M06dpa R
Guitar Amp 3	MRS-HG06dpa L
Guitar Amp 3	MRS-HG06dpa R
Guitar Amp 3	MS-59SLdpa01L
Guitar Amp 3	MS-59SLdpa01R
Guitar Amp 3	MS-59SLdpa06L
Guitar Amp 3	MS-59SLdpa06R
Guitar Amp 3	MS-59SLdpa15L
Guitar Amp 3	MS-59SLdpa15R
Guitar Amp 3	MAES-60m02rvL
Guitar Amp 3	MAES-60m02rvR
Guitar Amp 3	PEG-60t5m1rvL
Guitar Amp 3	PEG-60t5m1rvR
Guitar Amp 3	FD-PRNC2ful1L
Guitar Amp 3	FD-PRNC2ful1R
Guitar Amp 3	FD-PRNC2ful2L
Guitar Amp 3	FD-PRNC2ful2R
Guitar Amp 3	FD-TRV4c15d6L
Guitar Amp 3	FD-TRV4c15d6R
Guitar Amp 3	GIB-GA06_M1 L
Guitar Amp 3	GIB-GA06_M1 R
Guitar Amp 3	GIB-GA06_M2 L
Guitar Amp 3	GIB-GA06_M2 R
Guitar Amp 3	GIB-GA20_M1 L
Guitar Amp 3	GIB-GA20_M1 R
Guitar Amp 3	GIB-GA20_M2 L
Guitar Amp 3	GIB-GA20_M2 R

Category	Type
Guitar Amp 3	RL-J12-5-L
Guitar Amp 3	RL-J12-5-R
Guitar Amp 3	RL-J12-FIF-L
Guitar Amp 3	RL-J12-FIF-R
Guitar Amp 3	RL-J12-Lo5-L
Guitar Amp 3	RL-J12-Lo5-R
Guitar Amp 3	RL-J12-LCB5-L
Guitar Amp 3	RL-J12-LCB5-R
Guitar Amp 3	RL-J12-Br5-L
Guitar Amp 3	RL-J12-Br5-R
Guitar Amp 3	RL-J12-BrF-L
Guitar Amp 3	RL-J12-BrF-R
Guitar Amp 3	RL-J12-Co5-L
Guitar Amp 3	RL-J12-Co5-R
Guitar Preamp	EN-53+DI cl
Guitar Preamp	EN-53+DI mt
Guitar Preamp	MB-F3+DI cl
Guitar Preamp	MB-F3+DI cr
Guitar Preamp	MB-F3+DI ds
Guitar Preamp	MB-TX+DI cl
Guitar Preamp	MB-TX+DI cr
Guitar Preamp	MB-TX+DI od
Guitar Preamp	MB-TX+DI ds
Guitar Preamp	MS-J1+DI cr
Guitar Preamp	MS-J1+DI ds
Guitar Preamp	YM-F112PRE
Guitar Preamp	YM-F115PRE
Guitar Preamp	RL-J12PrT-251
Guitar Preamp	RL-J12PrT-252
Guitar Preamp	RL-J12PrT-253
Guitar Preamp	RL-J12PrT-2F
Guitar Preamp	RL-J12PrTB2F
Guitar Preamp	RL-J12PrT-25c
Guitar Preamp	RL-J12PrT-25v
Guitar Preamp	RL-J12PrT-2Fc
Guitar Preamp	RL-J12PrT-2Fv
Guitar Preamp	RL-J12Pr1-25
Guitar Preamp	RL-J12Pr1-2F

Category	Type
Guitar Preamp	RL-J12Pr1B25
Guitar Preamp	RL-J12Pr1B2F
Guitar Preamp	RL-J12Pr2B35d
Guitar Preamp	RL-J12Pr2-25r
Guitar Preamp	RL-J12Pr2B25c
Guitar Preamp	RL-J12Pr2B25v
Guitar Preamp	RL-J12Sp-5-L
Guitar Preamp	RL-J12Sp-5-R
Guitar Preamp	RL-J12Sp-F-L
Guitar Preamp	RL-J12Sp-F-R
Guitar Preamp	RL-J12Sp-Co5L
Guitar Preamp	RL-J12Sp-Co5R
Guitar Preamp	RL-J12Sp-CB5L
Guitar Preamp	RL-J12Sp-CB5R
Guitar Preamp	RL-J12Sp-CoFL
Guitar Preamp	RL-J12Sp-CoFR
Acou Amp	LY-3C-AC
Bass Amp	BASS-CMB
Bass Amp	FD-BMAN
Bass Amp	BASS-STK
Bass Amp	AC-360 cl1
Bass Amp	AC-360 cl2
Bass Amp	EB-C450 cl
Bass Amp	EB-C450 cr
Bass Amp	FD-BMNtw cr
Bass Amp	FD-BMNtw od
Bass Amp	FD-BMNs v cl1
Bass Amp	FD-BMNs v cl2
Bass Amp	FD-BMNbk cl1
Bass Amp	FD-BMNbk cl2
Bass Amp	FD-STBAS cl1
Bass Amp	FD-STBAS cl2
Bass Amp	GK-150 cl1
Bass Amp	GK-150 cl2
Bass Amp	GK-150DI
Bass Amp	MK-T501 cl1
Bass Amp	MK-T501 cl2
Bass Amp	MK-T501 cl3

Category	Type
Bass Amp	SW-PB20 cl1
Bass Amp	SW-PB20 cl2
Bass Amp	SW-PB20 cl3
Bass Amp	SW-SM50 cl1
Bass Amp	SW-SM50 cl2
Bass Amp	SW-SM50 cl3
Bass Preamp	AP-SV4DI cl1
Bass Preamp	AP-SV4DI cl2
EP Preamp 1	RD-PRE-FF00
EP Preamp 1	RD-PsvCenter
EP Preamp 1	RD-FD-RrSp0L
EP Preamp 1	RD-FD-RrSp0R
EP Preamp 1	RD-FD-RrSp3L
EP Preamp 1	RD-FD-RrSp3R
EP Preamp 1	RD-FD-Sp0L
EP Preamp 1	RD-FD-Sp0R
EP Preamp 1	RD-FD-Sp4L
EP Preamp 1	RD-FD-Sp4R
EP Preamp 1	RD-SvPRE-05-L
EP Preamp 1	RD-SvPRE-05-R
EP Preamp 1	RD-SvPRE-0F-L
EP Preamp 1	RD-SvPRE-0F-R
EP Preamp 1	RD-SvPRE-5F-L
EP Preamp 1	RD-SvPRE-5F-R
EP Preamp 1	RD-SvPRE-FF-L
EP Preamp 1	RD-SvPRE-FF-R
EP Preamp 1	RD-PETPRE cnt
EP Preamp 1	RD-PETPRE tbF
EP Preamp 1	RD-PETPRE lo-
EP Preamp 1	RD-PETPREIo-2
EP Preamp 1	RD-PETPRE nrm
EP Preamp 1	RD-PETPREI-t+
EP Preamp 1	RD-PETPRE t+2
EP Preamp 1	RD-PETPRI-t+2
EP Preamp 1	RD-PETPREtrm1
EP Preamp 1	RD-PETPREtrm2
EP Preamp 1	RD-PETPREtrm3
EP Preamp 1	RD-PETPREtrmf

Category	Type
EP Preamp 1	RD-PETPRE-1FL
EP Preamp 1	RD-PETPRE-1FR
EP Preamp 1	RD-PETPRE-55L
EP Preamp 1	RD-PETPRE-55R
EP Preamp 1	RD-PETPRE-5FL
EP Preamp 1	RD-PETPRE-5FR
EP Preamp 1	RD-PETPRE-FFL
EP Preamp 1	RD-PETPRE-FFR
EP Preamp 1	RD-MK1PRE fit
EP Preamp 1	RD-MK1PRE nrm
EP Preamp 1	RD-MK1PREt+b-
EP Preamp 1	RD-MK1PRE tbF
EP Preamp 1	RD-MK1PRE tb2
EP Preamp 1	RD-MK1PRE tb3
EP Preamp 1	RD-MK1PRE tb5
EP Preamp 1	RD-MK1PRt5b-5
EP Preamp 1	RD-MK1PREtb-3
EP Preamp 1	RD-MK1PREtb-5
EP Preamp 1	RD-MK1PRE vb
EP Preamp 1	RD-MK1PRE fvb
EP Preamp 1	RD-MK1PREsetB
EP Preamp 1	RD-MK1PRE-05L
EP Preamp 1	RD-MK1PRE-05R
EP Preamp 1	RD-MK1PRE-0FL
EP Preamp 1	RD-MK1PRE-0FR
EP Preamp 1	RD-MK1PRE-55L
EP Preamp 1	RD-MK1PRE-55R
EP Preamp 1	RD-MK1PRE-5FL
EP Preamp 1	RD-MK1PRE-5FR
EP Preamp 1	RD-MK2PRE cnt
EP Preamp 1	RD-MK2PRE lo-
EP Preamp 1	RD-MK2PRE hi+
EP Preamp 1	RD-MK2PRE nrm
EP Preamp 1	RD-MK2PRE 0vb
EP Preamp 1	RD-MK2PRE Fvb
EP Preamp 1	RD-MK2PRE hi-
EP Preamp 1	RD-MK2PRE hl-
EP Preamp 1	RD-MK2PRE lo+

Category	Type
EP Preamp 1	RD-MK2PRE-5F
EP Preamp 1	RD-MK2PRE-FF
EP Preamp 1	RD-MK2PREMinF
EP Preamp 1	RD-MK2PRE-0FL
EP Preamp 1	RD-MK2PRE-0FR
EP Preamp 1	RD-MK2PRE-55L
EP Preamp 1	RD-MK2PRE-55R
EP Preamp 1	RD-MK2PRE-5FL
EP Preamp 1	RD-MK2PRE-5FR
EP Preamp 1	RD-MK2PRE-FFL
EP Preamp 1	RD-MK2PRE-FFR
EP Preamp 1	RD-DMYPRE bs+
EP Preamp 1	RD-DMYPREbsmd
EP Preamp 1	RD-DMYPRE ot+
EP Preamp 1	RD-DMYPREovtm
EP Preamp 1	RD-DMYPREovtF
EP Preamp 1	RD-DMYPRE nrm
EP Preamp 1	RD-DMYPREaltB
EP Preamp 1	RD-DMYP-Tpn3L
EP Preamp 1	RD-DMYP-Tpn3R
EP Preamp 1	RD-STWPRE nrm
EP Preamp 1	RD-STWPRE min
EP Preamp 1	RD-STWPRE hi+
EP Preamp 1	RD-STWPRE hiF
EP Preamp 1	RD-STWPREh+l+
EP Preamp 1	RD-STWPREhFl-
EP Preamp 2	WR-200PRE po
EP Preamp 2	WR-200PRE po2
EP Preamp 2	WR-200PRE spo
EP Preamp 2	WR-200PREspo2
EP Preamp 2	WR-200PREtrm1
EP Preamp 2	WR-200PREtrm2
EP Preamp 2	WR-200PREtrpo
EP Preamp 2	WR-200PRtrspo
EP Preamp 2	WR-200PRE-3dB
EP Preamp 2	WR-200PRE-Ful
EP Preamp 2	VV-RdMonFF00
EP Preamp 2	YM-CPPRE nrm

Category	Type
EP Preamp 2	YM-CPPRE flt
EP Preamp 2	YM-CPPRE lo-
EP Preamp 2	YM-CPPRE bs-
EP Preamp 2	YM-CPPRE mid-
EP Preamp 2	YM-CPPRE tb-
EP Preamp 2	YM-CPPREbass+
EP Preamp 2	YM-CPPRE full
EP Preamp 2	YM-CPPREtrm
EP Preamp 2	YM-CPPREtrml-
EP Preamp 2	YM-CPPREtrmm+
EP Preamp 2	YM-CPPREtrmt+
EP Preamp 2	YM-CPPRE-00FL
EP Preamp 2	YM-CPPRE-00FR
EP Preamp 2	YM-CPPRE-05FL
EP Preamp 2	YM-CPPRE-05FR
EP Preamp 2	YM-CPPRE-22FL
EP Preamp 2	YM-CPPRE-22FR
EP Preamp 2	CLV-TABPREful
EP Preamp 2	CLV-TABPREbri
EP Preamp 2	CLV-TABPREtrb
EP Preamp 2	CLV-TABPREsft
EP Preamp 2	CLV-CMBPREnbr
EP Preamp 2	CLV-CMBPREntb
EP Preamp 2	CLV-CMBPREnmd
EP Preamp 2	CLV-CMBPREnsf
EP Preamp 2	CLV-CMBPREmed
EP Preamp 2	CLV-CMBPREsft
EP Preamp 2	CLV-CMBPRmsft
EP Preamp 2	CLV-CMBPRtsft
EP Preamp 2	CLV-CMBPbtsft
Organ Amp	LES-Mc1mHnOfL
Organ Amp	LES-Mc1mHnOfR
Organ Amp	LES-Mc1mHnOnL
Organ Amp	LES-Mc1mHnOnR
Organ Amp	LES-McHiHnOfL
Organ Amp	LES-McHiHnOfR
Organ Amp	LES-McHiHnOnL
Organ Amp	LES-McHiHnOnR

Category	Type
Organ Amp	LES-McLoHnOfL
Organ Amp	LES-McLoHnOfR
Organ Amp	LES-McLoHnOnL
Organ Amp	LES-McLoHnOnR
Organ Amp	LES-McMxHnOfL
Organ Amp	LES-McMxHnOfR
Organ Amp	LES-McMxHnOnL
Organ Amp	LES-McMxHnOnR
Inst Amp	RL-CBKB
Audio Device	SPK-7VINT L
Audio Device	SPK-7VINT R
Audio Device	SPK-DTOP-2B L
Audio Device	SPK-DTOP-2B R
Audio Device	SPK-DSCPOOL L
Audio Device	SPK-DSCPOOL R
Audio Device	SPK-SILmicroL
Audio Device	SPK-SILmicroR
Audio Device	TOYSP-RNGO L
Audio Device	TOYSP-RNGO R
Audio Device	TOYSP-SYUBO L
Audio Device	TOYSP-SYUBO R
Audio Device	MEGAPH-FET L
Audio Device	MEGAPH-FET R
Audio Device	TV-37 L
Audio Device	TV-37 R
Audio Device	TV-SAMS-50 L
Audio Device	TV-SAMS-50 R
Audio Device	RADIO-SailBkL
Audio Device	RADIO-SailBkR
Audio Device	RADIO-NICO L
Audio Device	RADIO-NICO R
Audio Device	RADIO-NOVK L
Audio Device	RADIO-NOVK R
Audio Device	RADIO-TELF L
Audio Device	RADIO-TELF R
Audio Device	RADIO-TSTR L
Audio Device	RADIO-TSTR R
Audio Device	RADIO-ZENT L

Category	Type
Audio Device	RADIO-ZENT R
Audio Device	RECPL-DANS L
Audio Device	RECPL-DANS R
Audio Device	RECPL-EDN L
Audio Device	RECPL-EDN R
Audio Device	RECPL-JOPH L
Audio Device	RECPL-JOPH R
Audio Device	RECPL-REDH L
Audio Device	RECPL-REDH R
Audio Device	RECPL-REEL L
Audio Device	RECPL-REEL R
Audio Device	PC-McMini L
Audio Device	PC-McMini R
Audio Device	PC-LAPTOP15 L
Audio Device	PC-LAPTOP15 R
Audio Device	TABLT-iPD3 L
Audio Device	TABLT-iPD3 R
Audio Device	TABLT-9G L
Audio Device	TABLT-9G R
Audio Device	PHONE-iPh5 L
Audio Device	PHONE-iPh5 R
Audio Device	PHONE-AK L
Audio Device	PHONE-AK R
Audio Device	EARP-WH L
Audio Device	EARP-WH R
Audio Device	HDPH-AV35BL L
Audio Device	HDPH-AV35BL R
Audio Device	CAR-OPL L
Audio Device	CAR-OPL R
Audio Device	CAR-SednPassL
Audio Device	CAR-SednPassR
Audio Device	GNL-Mic-0-L
Audio Device	GNL-Mic-0-R
Audio Device	GNL-Mic-3-L
Audio Device	GNL-Mic-3-R
Audio Device	GNL-Mic-6-L
Audio Device	GNL-Mic-6-R
Other Preamp	LES-CMBPREnrm

Category	Type
Other Preamp	LES-CMBPREdrv
Other Preamp	LES-CMBPREbas
Other Preamp	LES-CMBPREclp
Other Preamp	LES-CMBPRE od
Other Preamp	LES-CMBPREodF
Other Preamp	RL-VPPRE drv
Other Preamp	RL-VPPRE ful
Other Preamp	RL-VPPRE nrm
Other Preamp	RL-VPPRE toff
Other Preamp	CountryM-DI
Other Preamp	RadiJDV-DI
Other Preamp	RadiPro48-DI
Other Preamp	RadiPro48-Pad
Other Preamp	RetroTube
Other Preamp	RetroTubeWt
Other Preamp	RetroTubeWtOd
Other Preamp	TTNX-LA2-00dB
Other Preamp	TTNX-LA2-03dB
Other Preamp	NEV-1272-3dbL
Other Preamp	NEV-1272-3dbR
Other Preamp	NEV-1272-6dbL
Other Preamp	NEV-1272-6dbR
Synth Module	MG-M-VCF co00
Synth Module	MG-M-VCF co01
Synth Module	MG-M-VCF co02
Synth Module	MG-M-VCF co03
Synth Module	MG-M-VCF co04
Synth Module	MG-M-VCF co05
Synth Module	MG-M-VCF co06
Synth Module	MG-M-VCF co07
Synth Module	MG-M-VCF co08
Synth Module	MG-M-VCF co09
Synth Module	MG-M-VCF co10
Synth Module	MG-M-VCFco0ol
Synth Module	MG-M-VCFco1ol
Synth Module	MG-M-VCFco2ol
Synth Module	MG-M-VCFco3ol
Synth Module	MG-M-VCFco4ol

Category	Type
Synth Module	MG-M-VCFco5ol
Synth Module	MG-M-VCFco6ol
Synth Module	MG-M-VCFco7ol
Synth Module	MG-M-VCFco8ol
Synth Module	MG-M-VCFco9ol
Synth Module	MG-M-VCFc10ol
Synth Module	MG-M-VCFc00nk
Synth Module	MG-M-VCFc01nk
Synth Module	MG-M-VCFc02nk
Synth Module	MG-M-VCFc03nk
Synth Module	MG-M-VCFc04nk
Synth Module	MG-M-VCFc05nk
Synth Module	MG-M-VCFc06nk
Synth Module	MG-M-VCFc07nk
Synth Module	MG-M-VCFc08nk
Synth Module	MG-M-VCFc09nk
Synth Module	MG-M-VCFc10nk
Synth Module	MG-Pha06P-Lo1
Synth Module	MG-Pha06P-Hi1
Synth Module	MG-Pha12P-Lo1
Synth Module	MG-Pha12P-Hi1
Effect 1	AC-SIM-CUB
Effect 1	AC-SIM-CDH
Effect 1	AC-SIM-ZOM1
Effect 1	AC-SIM-ZOM2
Effect 1	APX-EXT-RED
Effect 1	APX-EXT-RED05
Effect 1	APX-EXT-RED07
Effect 1	APX-EXT-RED09
Effect 1	APX-EXT-VIN
Effect 1	APX-EXT-VIN05
Effect 1	APX-EXT-VIN07
Effect 1	APX-EXT-VIN09
Effect 1	APX-A602B-50L
Effect 1	APX-A602B-50R
Effect 1	APX-A602B-90L
Effect 1	APX-A602B-90R
Effect 1	APX-ST2-FIHIL

Category	Type
Effect 1	APX-ST2-FIHIR
Effect 1	APX-ST2-MoHiL
Effect 1	APX-ST2-MoHiR
Effect 1	STR-EXT gin-
Effect 1	STR-EXT gin+
Effect 1	STR-EXT nsgn-
Effect 1	STR-EXTAnsgn-
Effect 1	NSF-EXT gin+
Effect 1	NSF-EXTA gin+
Effect 1	SS-RED cl-off
Effect 1	SS-RED cloff1
Effect 1	SS-RED cloff2
Effect 1	SS-RED cloffS
Effect 1	SS-RED cloffF
Effect 1	SS-RED cl-on
Effect 1	SS-RED cl-on1
Effect 1	SS-RED cl-on2
Effect 1	SS-RED clonSI
Effect 1	SS-RED clonFs
Effect 1	SS-OLD cl-off
Effect 1	SS-OLD cloff1
Effect 1	SS-OLD cloff2
Effect 1	SS-OLD cloffS
Effect 1	SS-OLD cloffF
Effect 1	SS-OLD cl-on
Effect 1	SS-OLD cl-on1
Effect 1	SS-OLD cl-on2
Effect 1	SS-OLD cl-onS
Effect 1	SS-OLD cl-onF
Effect 1	EPX-PRE-DI1
Effect 1	EPX-PRE-DI2
Effect 1	EPX-PRE-Dry1
Effect 1	EPX-PRE-Dry2
Effect 1	EPX-PRELGDI1
Effect 1	EPX-PREShDIy1
Effect 1	EPX-PRELGDIy1
Effect 1	MAE-Pha-1
Effect 1	MAE-Pha-2

Category	Type
Effect 1	MAE-Pha-SI
Effect 1	MAE-Pha-Fs
Effect 1	MXO-Pha-1
Effect 1	MX-Cho120012L
Effect 1	MX-Cho120012R
Effect 1	MX-Cho121200L
Effect 1	MX-Cho121200R
Effect 1	MX-Cho121212L
Effect 1	MX-Cho121212R
Effect 1	MX-Cho12FF12L
Effect 1	MX-Cho12FF12R
Effect 1	MX-Pha90-Blk1
Effect 1	MX-Pha90-BlkS
Effect 1	MX-Pha90-Led1
Effect 1	MX-Pha90-LedS
Effect 1	MX-Pha90-Old1
Effect 1	MX-Pha90-OldS
Effect 1	MX-Pha-Blkm 1
Effect 1	MX-Pha-Scrp 1
Effect 1	OBH-Pha 1
Effect 1	OBH-Pha SI
Effect 1	OBH-Pha Fs1
Effect 2	UVB-PhaCho 1
Effect 2	UVB-PhaChoSI
Effect 2	UVB-PhaChoMo1
Effect 2	UVB-PhaChoMoS
Effect 2	UVB-PhaVib
Effect 2	UVB-PhaVibSI
Effect 2	UVB-PhaVibMoS
Effect 2	SEI-Fuz Soft
Effect 2	SEI-Fuz Hard
Effect 2	SEI-SFuzTonDI
Effect 2	SEI-SFuzTonUp
Effect 2	VX-FuzDown 1
Effect 2	VX-FuzUp 1
Effect 2	BOS-CE1-F5-L
Effect 2	BOS-CE1-F5-R
Effect 2	BOS-CE1-FMaxL

Category	Type
Effect 2	BOS-CE1-FMaxR
Effect 2	BOS-CE1-OvidL
Effect 2	BOS-CE1-OvidR
Effect 2	RL-DIMEN-SW1L
Effect 2	RL-DIMEN-SW1R
Effect 2	RL-DIMEN-SW2L
Effect 2	RL-DIMEN-SW2R
Effect 2	RL-DIMEN-SW3L
Effect 2	RL-DIMEN-SW3R
Effect 2	RL-DIMEN-SW4L
Effect 2	RL-DIMEN-SW4R
Effect 2	TCE-1210St1-L
Effect 2	TCE-1210St1-R
Effect 2	TCE-1210St2-L
Effect 2	TCE-1210St2-R
Effect 3	DEK-Cas-Dk10L
Effect 3	DEK-Cas-Dk10R
Effect 3	DEK-Cas-MdFIL
Effect 3	DEK-Cas-MdFIR
Effect 3	DEK-Cas-BrFIL
Effect 3	DEK-Cas-BrFIR
Effect 3	DEK-Stu-Dk10L
Effect 3	DEK-Stu-Dk10R
Effect 3	DEK-Stu-MdFIL
Effect 3	DEK-Stu-MdFIR
Effect 3	DEK-Stu-BrFIL
Effect 3	DEK-Stu-BrFIR
Effect 3	STEC-AN2-55-L
Effect 3	STEC-AN2-55-R
Effect 3	STEC-AN2-FF-L
Effect 3	STEC-AN2-FF-R
Equalizer 1	Flat
Equalizer 1	SSL lcut00
Equalizer 1	SSL lcut10
Equalizer 1	SSL lcut20
Equalizer 1	SSL lcut40
Equalizer 1	SSL lcut70
Equalizer 1	SSL lcut120

Category	Type
Equalizer 1	SSL lmcut160
Equalizer 1	SSL lmcut200
Equalizer 1	SSL lmcut300
Equalizer 1	SSL lmcut400
Equalizer 1	SSL air med
Equalizer 1	SSL air ful
Equalizer 1	TRB-BSTslight
Equalizer 1	TRB-BST half
Equalizer 1	TRB-BST med
Equalizer 1	TRB-BST full
Equalizer 1	PARA-BST h
Equalizer 1	PARA-BST h+
Equalizer 1	PARA-BST h+m+
Equalizer 1	PARA-BST h++
Equalizer 1	PARA-BST hm
Equalizer 1	PARA-BSThm ms
Equalizer 1	BASFIL flat
Equalizer 1	BASFIL shl00
Equalizer 1	BASFIL shl10
Equalizer 1	BASFIL shl20
Equalizer 1	BASFIL shl30
Equalizer 1	BASFIL shl40
Equalizer 1	BASFIL shl50
Equalizer 1	BASFIL shl60
Equalizer 1	BASFIL shl70
Equalizer 1	BASFIL shl80
Equalizer 1	BASFIL shl90
Equalizer 1	BASFIL dep00
Equalizer 1	BASFIL dep10
Equalizer 1	BASFIL dep20
Equalizer 1	BASFIL dep30
Equalizer 1	BASFIL dep40
Equalizer 1	BASFIL dep50
Equalizer 1	BASFIL dep60
Equalizer 1	BASFIL dep75
Equalizer 1	BASFIL dep90
Equalizer 1	SPRK-EQ w/b
Equalizer 1	SPRK-EQ med

Category	Type
Equalizer 1	SPRK-EQup bas
Equalizer 1	SPRK-EQup w/b
Equalizer 2	E-Hb6Q10-04KL
Equalizer 2	E-Hb6Q10-04KR
Equalizer 2	E-Hb6Q10-05KL
Equalizer 2	E-Hb6Q10-05KR
Equalizer 2	E-Hb6Q10-06KL
Equalizer 2	E-Hb6Q10-06KR
Equalizer 2	E-Hb6Q10-07KL
Equalizer 2	E-Hb6Q10-07KR
Equalizer 2	E-Hb6Q10-08KL
Equalizer 2	E-Hb6Q10-08KR
Equalizer 2	E-Hb6Q10-09KL
Equalizer 2	E-Hb6Q10-09KR
Equalizer 2	E-Hb6Q10-10KL
Equalizer 2	E-Hb6Q10-10KR
Equalizer 2	E-Hb6Q10-11KL
Equalizer 2	E-Hb6Q10-11KR
Equalizer 2	E-Hb6Q10-12KL
Equalizer 2	E-Hb6Q10-12KR
Equalizer 2	E-Hb6Q10-13KL
Equalizer 2	E-Hb6Q10-13KR
Equalizer 2	E-Hb6Q10-14KL
Equalizer 2	E-Hb6Q10-14KR
Equalizer 2	E-Hb6Q10-15KL
Equalizer 2	E-Hb6Q10-15KR
Equalizer 2	E-Hb6Q10-16KL
Equalizer 2	E-Hb6Q10-16KR
Equalizer 2	E-Hb6Q10-17KL
Equalizer 2	E-Hb6Q10-17KR
Equalizer 2	E-Hb6Q10-18KL
Equalizer 2	E-Hb6Q10-18KR
Equalizer 2	E-Hb6Q10-19KL
Equalizer 2	E-Hb6Q10-19KR
Equalizer 2	E-Hb6Q10-20KL
Equalizer 2	E-Hb6Q10-20KR
Equalizer 2	E-Hb6Q14-04KL
Equalizer 2	E-Hb6Q14-04KR

Category	Type
Equalizer 2	E-Hb6Q14-05KL
Equalizer 2	E-Hb6Q14-05KR
Equalizer 2	E-Hb6Q14-06KL
Equalizer 2	E-Hb6Q14-06KR
Equalizer 2	E-Hb6Q14-07KL
Equalizer 2	E-Hb6Q14-07KR
Equalizer 2	E-Hb6Q14-08KL
Equalizer 2	E-Hb6Q14-08KR
Equalizer 2	E-Hb6Q14-09KL
Equalizer 2	E-Hb6Q14-09KR
Equalizer 2	E-Hb6Q14-10KL
Equalizer 2	E-Hb6Q14-10KR
Equalizer 2	E-Hb6Q14-11KL
Equalizer 2	E-Hb6Q14-11KR
Equalizer 2	E-Hb6Q14-12KL
Equalizer 2	E-Hb6Q14-12KR
Equalizer 2	E-Hb6Q14-13KL
Equalizer 2	E-Hb6Q14-13KR
Equalizer 2	E-Hb6Q14-14KL
Equalizer 2	E-Hb6Q14-14KR
Equalizer 2	E-Hb6Q14-15KL
Equalizer 2	E-Hb6Q14-15KR
Equalizer 2	E-Hb6Q14-16KL
Equalizer 2	E-Hb6Q14-16KR
Equalizer 2	E-Hb6Q14-17KL
Equalizer 2	E-Hb6Q14-17KR
Equalizer 2	E-Hb6Q14-18KL
Equalizer 2	E-Hb6Q14-18KR
Equalizer 2	E-Hb6Q14-19KL
Equalizer 2	E-Hb6Q14-19KR
Equalizer 2	E-Hb6Q14-20KL
Equalizer 2	E-Hb6Q14-20KR
Equalizer 2	E-Hb6Q20-04KL
Equalizer 2	E-Hb6Q20-04KR
Equalizer 2	E-Hb6Q20-05KL
Equalizer 2	E-Hb6Q20-05KR
Equalizer 2	E-Hb6Q20-06KL
Equalizer 2	E-Hb6Q20-06KR

Category	Type
Equalizer 2	E-Hb6Q20-07KL
Equalizer 2	E-Hb6Q20-07KR
Equalizer 2	E-Hb6Q20-08KL
Equalizer 2	E-Hb6Q20-08KR
Equalizer 2	E-Hb6Q20-09KL
Equalizer 2	E-Hb6Q20-09KR
Equalizer 2	E-Hb6Q20-10KL
Equalizer 2	E-Hb6Q20-10KR
Equalizer 2	E-Hb6Q20-11KL
Equalizer 2	E-Hb6Q20-11KR
Equalizer 2	E-Hb6Q20-12KL
Equalizer 2	E-Hb6Q20-12KR
Equalizer 2	E-Hb6Q20-13KL
Equalizer 2	E-Hb6Q20-13KR
Equalizer 2	E-Hb6Q20-14KL
Equalizer 2	E-Hb6Q20-14KR
Equalizer 2	E-Hb6Q20-15KL
Equalizer 2	E-Hb6Q20-15KR
Equalizer 2	E-Hb6Q20-16KL
Equalizer 2	E-Hb6Q20-16KR
Equalizer 2	E-Hb6Q20-17KL
Equalizer 2	E-Hb6Q20-17KR
Equalizer 2	E-Hb6Q20-18KL
Equalizer 2	E-Hb6Q20-18KR
Equalizer 2	E-Hb6Q20-19KL
Equalizer 2	E-Hb6Q20-19KR
Equalizer 2	E-Hb6Q20-20KL
Equalizer 2	E-Hb6Q20-20KR
Equalizer 3	E-LoCt00 BypL
Equalizer 3	E-LoCt00 BypR
Equalizer 3	E-LoCt06 BypL
Equalizer 3	E-LoCt06 BypR
Equalizer 3	E-LoCt06 020L
Equalizer 3	E-LoCt06 020R
Equalizer 3	E-LoCt06 030L
Equalizer 3	E-LoCt06 030R
Equalizer 3	E-LoCt06 040L
Equalizer 3	E-LoCt06 040R

Category	Type
Equalizer 3	E-LoCt06 050L
Equalizer 3	E-LoCt06 050R
Equalizer 3	E-LoCt06 060L
Equalizer 3	E-LoCt06 060R
Equalizer 3	E-LoCt06 070L
Equalizer 3	E-LoCt06 070R
Equalizer 3	E-LoCt06 080L
Equalizer 3	E-LoCt06 080R
Equalizer 3	E-LoCt06 090L
Equalizer 3	E-LoCt06 090R
Equalizer 3	E-LoCt06 100L
Equalizer 3	E-LoCt06 100R
Equalizer 3	E-LoCt06 110L
Equalizer 3	E-LoCt06 110R
Equalizer 3	E-LoCt06 120L
Equalizer 3	E-LoCt06 120R
Equalizer 3	E-LoCt06 130L
Equalizer 3	E-LoCt06 130R
Equalizer 3	E-LoCt06 140L
Equalizer 3	E-LoCt06 140R
Equalizer 3	E-LoCt06 150L
Equalizer 3	E-LoCt06 150R
Equalizer 3	E-LoCt06 160L
Equalizer 3	E-LoCt06 160R
Equalizer 3	E-LoCt06 170L
Equalizer 3	E-LoCt06 170R
Equalizer 3	E-LoCt06 180L
Equalizer 3	E-LoCt06 180R
Equalizer 3	E-LoCt06 190L
Equalizer 3	E-LoCt06 190R
Equalizer 3	E-LoCt06 200L
Equalizer 3	E-LoCt06 200R
Equalizer 3	E-LoCt06 210L
Equalizer 3	E-LoCt06 210R
Equalizer 3	E-LoCt06 220L
Equalizer 3	E-LoCt06 220R
Equalizer 3	E-LoCt06 230L
Equalizer 3	E-LoCt06 230R

Category	Type
Equalizer 3	E-LoCt06 240L
Equalizer 3	E-LoCt06 240R
Equalizer 3	E-LoCt06 250L
Equalizer 3	E-LoCt06 250R
Equalizer 3	E-LoCt06 260L
Equalizer 3	E-LoCt06 260R
Equalizer 3	E-LoCt06 270L
Equalizer 3	E-LoCt06 270R
Equalizer 3	E-LoCt06 280L
Equalizer 3	E-LoCt06 280R
Equalizer 3	E-LoCt06 290L
Equalizer 3	E-LoCt06 290R
Equalizer 3	E-LoCt06 300L
Equalizer 3	E-LoCt06 300R
Equalizer 3	E-LoCt06 310L
Equalizer 3	E-LoCt06 310R
Equalizer 3	E-LoCt06 320L
Equalizer 3	E-LoCt06 320R
Equalizer 3	E-LoCt06 330L
Equalizer 3	E-LoCt06 330R
Equalizer 3	E-LoCt06 340L
Equalizer 3	E-LoCt06 340R
Equalizer 3	E-LoCt06 350L
Equalizer 3	E-LoCt06 350R
Equalizer 3	E-LoCt06 360L
Equalizer 3	E-LoCt06 360R
Equalizer 3	E-LoCt06 370L
Equalizer 3	E-LoCt06 370R
Equalizer 3	E-LoCt06 380L
Equalizer 3	E-LoCt06 380R
Equalizer 3	E-LoCt06 390L
Equalizer 3	E-LoCt06 390R
Equalizer 3	E-LoCt06 400L
Equalizer 3	E-LoCt06 400R
Equalizer 3	E-LoCt06 410L
Equalizer 3	E-LoCt06 410R
Equalizer 3	E-LoCt06 420L
Equalizer 3	E-LoCt06 420R

Category	Type
Equalizer 3	E-LoCt06 430L
Equalizer 3	E-LoCt06 430R
Equalizer 3	E-LoCt06 440L
Equalizer 3	E-LoCt06 440R
Equalizer 3	E-LoCt06 450L
Equalizer 3	E-LoCt06 450R
Equalizer 3	E-LoCt06 460L
Equalizer 3	E-LoCt06 460R
Equalizer 3	E-LoCt06 470L
Equalizer 3	E-LoCt06 470R
Equalizer 3	E-LoCt06 480L
Equalizer 3	E-LoCt06 480R
Equalizer 4	E-40Q2-3-04KL
Equalizer 4	E-40Q2-3-04KR
Equalizer 4	E-40Q2-3-05KL
Equalizer 4	E-40Q2-3-05KR
Equalizer 4	E-40Q2-3-06KL
Equalizer 4	E-40Q2-3-06KR
Equalizer 4	E-40Q2-3-07KL
Equalizer 4	E-40Q2-3-07KR
Equalizer 4	E-40Q2-3-08KL
Equalizer 4	E-40Q2-3-08KR
Equalizer 4	E-40Q2-3-09KL
Equalizer 4	E-40Q2-3-09KR
Equalizer 4	E-40Q2-3-10KL
Equalizer 4	E-40Q2-3-10KR
Equalizer 4	E-40Q2-3-11KL
Equalizer 4	E-40Q2-3-11KR
Equalizer 4	E-40Q2-3-12KL
Equalizer 4	E-40Q2-3-12KR
Equalizer 4	E-40Q2-3-13KL
Equalizer 4	E-40Q2-3-13KR
Equalizer 4	E-40Q2-3-14KL
Equalizer 4	E-40Q2-3-14KR
Equalizer 4	E-40Q2-3-15KL
Equalizer 4	E-40Q2-3-15KR
Equalizer 4	E-40Q2-3-16KL
Equalizer 4	E-40Q2-3-16KR

Category	Type
Equalizer 4	E-40Q2-3-17KL
Equalizer 4	E-40Q2-3-17KR
Equalizer 4	E-40Q2-3-18KL
Equalizer 4	E-40Q2-3-18KR
Equalizer 4	E-40Q2-3-19KL
Equalizer 4	E-40Q2-3-19KR
Equalizer 4	E-40Q2-3-20KL
Equalizer 4	E-40Q2-3-20KR
Equalizer 4	E-40Q2-6-04KL
Equalizer 4	E-40Q2-6-04KR
Equalizer 4	E-40Q2-6-05KL
Equalizer 4	E-40Q2-6-05KR
Equalizer 4	E-40Q2-6-06KL
Equalizer 4	E-40Q2-6-06KR
Equalizer 4	E-40Q2-6-07KL
Equalizer 4	E-40Q2-6-07KR
Equalizer 4	E-40Q2-6-08KL
Equalizer 4	E-40Q2-6-08KR
Equalizer 4	E-40Q2-6-09KL
Equalizer 4	E-40Q2-6-09KR
Equalizer 4	E-40Q2-6-10KL
Equalizer 4	E-40Q2-6-10KR
Equalizer 4	E-40Q2-6-11KL
Equalizer 4	E-40Q2-6-11KR
Equalizer 4	E-40Q2-6-12KL
Equalizer 4	E-40Q2-6-12KR
Equalizer 4	E-40Q2-6-13KL
Equalizer 4	E-40Q2-6-13KR
Equalizer 4	E-40Q2-6-14KL
Equalizer 4	E-40Q2-6-14KR
Equalizer 4	E-40Q2-6-15KL
Equalizer 4	E-40Q2-6-15KR
Equalizer 4	E-40Q2-6-16KL
Equalizer 4	E-40Q2-6-16KR
Equalizer 4	E-40Q2-6-17KL
Equalizer 4	E-40Q2-6-17KR
Equalizer 4	E-40Q2-6-18KL
Equalizer 4	E-40Q2-6-18KR

Category	Type
Equalizer 4	E-40Q2-6-19KL
Equalizer 4	E-40Q2-6-19KR
Equalizer 4	E-40Q2-6-20KL
Equalizer 4	E-40Q2-6-20KR
Equalizer 4	E-001Lo12 L
Equalizer 4	E-001Lo12 R
Equalizer 4	E-001Lo16 L
Equalizer 4	E-001Lo16 R
Equalizer 4	E-002LoMd12 L
Equalizer 4	E-002LoMd12 R
Equalizer 4	E-002LoMd16 L
Equalizer 4	E-002LoMd16 R
Equalizer 4	E-003HiMd12 L
Equalizer 4	E-003HiMd12 R
Equalizer 4	E-003HiMd16 L
Equalizer 4	E-003HiMd16 R
Equalizer 4	E-004Hi12 L
Equalizer 4	E-004Hi12 R
Equalizer 4	E-004Hi16 L
Equalizer 4	E-004Hi16 R
Song 1	S-Albeniz L
Song 1	S-Albeniz R
Song 1	S-Bch-FrnchL
Song 1	S-Bch-FrnchR
Song 1	S-Bch-FrnchEL
Song 1	S-Bch-FrnchER
Song 1	S-Bet-Sn2301L
Song 1	S-Bet-Sn2301R
Song 1	S-Bet-Sn2302L
Song 1	S-Bet-Sn2302R
Song 1	S-Bet-Sn2303L
Song 1	S-Bet-Sn2303R
Song 1	S-Bet-Sn3201L
Song 1	S-Bet-Sn3201R
Song 1	S-Bet-Sn3202L
Song 1	S-Bet-Sn3202R
Song 1	S-Biz-HorrowL
Song 1	S-Biz-HorrowR

Category	Type
Song 1	S-Brm-HangarL
Song 1	S-Brm-HangarR
Song 1	S-Brm-IntermL
Song 1	S-Brm-IntermR
Song 1	S-Brm-VWaltzL
Song 1	S-Brm-VWaltzR
Song 1	S-Brm-VariatL
Song 1	S-Brm-VariatR
Song 1	S-Chp-Etude9L
Song 1	S-Chp-Etude9R
Song 1	S-Chp-EtudeFL
Song 1	S-Chp-EtudeFR
Song 1	S-Chp-MazulkL
Song 1	S-Chp-MazulkR
Song 1	S-Chp-TarantL
Song 1	S-Chp-TarantR
Song 1	S-Chp-WaltzDL
Song 1	S-Chp-WaltzDR
Song 1	S-Chp-WalzDbL
Song 1	S-Chp-WalzDbR
Song 1	S-Chp-WaltzGL
Song 1	S-Chp-WaltzGR
Song 1	S-Deb-Etude L
Song 1	S-Deb-Etude R
Song 1	S-Deb-Pre113L
Song 1	S-Deb-Pre113R
Song 1	S-Deb-PreludL
Song 1	S-Deb-PreludR
Song 1	S-Gsh-NobodyL
Song 1	S-Gsh-NobodyR
Song 1	S-Gsh-TheManL
Song 1	S-Gsh-TheManR
Song 1	S-Grn-Goya L
Song 1	S-Grn-Goya R
Song 1	S-Grg-Lyric L
Song 1	S-Grg-Lyric R
Song 1	S-Hyd-SonataL
Song 1	S-Hyd-SonataR

Category	Type
Song 1	S-Lzt-Annee L
Song 1	S-Lzt-Annee R
Song 1	S-Lzt-Etude L
Song 1	S-Lzt-Etude R
Song 1	S-Lzt-Garop L
Song 1	S-Lzt-Garop R
Song 1	S-Lzt-Valse L
Song 1	S-Lzt-Valse R
Song 1	S-Prk-Etude L
Song 1	S-Prk-Etude R
Song 1	S-Rvl-Valse L
Song 1	S-Rvl-Valse R
Song 1	S-ScI-SonataL
Song 1	S-ScI-SonataR
Song 1	S-Sch-Inter L
Song 1	S-Sch-Inter R
Song 1	S-Sch-KinderL
Song 1	S-Sch-KinderR
Song 1	S-Sch-Scene L
Song 1	S-Sch-Scene R
Song 1	S-Tch-SeasonL
Song 1	S-Tch-SeasonR
Song 2	S-AllMyLov L
Song 2	S-AllMyLov R
Song 2	S-AllTheTngsL
Song 2	S-AllTheTngsR
Song 2	S-BegnTheBegL
Song 2	S-BegnTheBegR
Song 2	S-BirdLndSuiL
Song 2	S-BirdLndSuiR
Song 2	S-CountryIntL
Song 2	S-CountryIntR
Song 2	S-Country L
Song 2	S-Country R
Song 2	S-FutureMem L
Song 2	S-FutureMem R
Song 2	S-Hubris L
Song 2	S-Hubris R

Category	Type
Song 2	S-IIIINevSmilL
Song 2	S-IIIINevSmilR
Song 2	S-ItsTalkTwnL
Song 2	S-ItsTalkTwnR
Song 2	S-LadyBGood L
Song 2	S-LadyBGood R
Song 2	S-LovBloom L
Song 2	S-LovBloom R
Song 2	S-MistyCd L
Song 2	S-MistyCd R
Song 2	S-MistyRe L
Song 2	S-MistyRe R
Song 2	S-MyFavor L
Song 2	S-MyFavor R
Song 2	S-MySongInt L
Song 2	S-MySongInt R
Song 2	S-MySong L
Song 2	S-MySong R
Song 2	S-OneOclk L
Song 2	S-OneOclk R
Song 2	S-RusanLulbyL
Song 2	S-RusanLulbyR
Song 2	S-SundaySng L
Song 2	S-SundaySng R
Song 2	S-ThtOldFeelL
Song 2	S-ThtOldFeelR
Song 2	S-WhatNotSo L
Song 2	S-WhatNotSo R
Song 2	S-WhereWereUL
Song 2	S-WhereWereUR
Song 2	S-KJKolnP1 L
Song 2	S-KJKolnP1 R
Song 2	S-KJKolnP2 L
Song 2	S-KJKolnP2 R
Song 2	S-KJKolnP3 L
Song 2	S-KJKolnP3 R
Song 2	S-KJKolnP4 L
Song 2	S-KJKolnP4 R

Category	Type
Song 2	S-SoftAs L
Song 2	S-SoftAs R
Song 2	S-SpkLike L
Song 2	S-SpkLike R
Song 2	S-Longing L
Song 2	S-Longing R
Song 2	S-Woods L
Song 2	S-Woods R
Song 2	S-CoronationL
Song 2	S-CoronationR
Song 2	S-Entertain L
Song 2	S-Entertain R
Song 2	S-Fatrances L
Song 2	S-Fatrances R
Song 2	S-MapleLfDryL
Song 2	S-MapleLfDryR
Song 2	S-MapleLfHalL
Song 2	S-MapleLfHalR
Song 2	S-NumbFum L
Song 2	S-NumbFum R
Song 2	S-Paragon L
Song 2	S-Paragon R
Song 2	S-RiffsSp L
Song 2	S-RiffsSp R
Song 2	S-SingRain L
Song 2	S-SingRain R
Song 2	S-SomeStool L
Song 2	S-SomeStool R
Song 2	S-Spaghetti L
Song 2	S-Spaghetti R
Song 3	S-Bhm-Tst L
Song 3	S-Bhm-Tst R
Song 3	S-Bhm-Edt L
Song 3	S-Bhm-Edt R
Song 3	S-Bhm-PfTst L
Song 3	S-Bhm-PfTst R
Song 3	S-Bhm-PfTst0L
Song 3	S-Bhm-PfTst0R

Category	Type
Song 3	S-Bhm-PfTs1bL
Song 3	S-Bhm-PfTs1bR
Song 3	S-Bhm-PfTst1L
Song 3	S-Bhm-PfTst1R
Song 3	S-Bhm-PfTst2L
Song 3	S-Bhm-PfTst2R
Song 3	S-Bhm-IntF1 L
Song 3	S-Bhm-IntF1 R
Song 3	S-Bhm-IntF2 L
Song 3	S-Bhm-IntF2 R
Song 3	S-Bhm-IntNz1L
Song 3	S-Bhm-IntNz1R
Song 3	S-Bhm-IntNz2L
Song 3	S-Bhm-IntNz2R
Song 3	S-Bhm-IntNz3L
Song 3	S-Bhm-IntNz3R
Song 3	S-BhmRePffItL
Song 3	S-BhmRePffItR
Song 3	S-Clk-IntFItL
Song 3	S-Clk-IntFItR
Song 3	S-BhmRe-F1 L
Song 3	S-BhmRe-F1 R
Song 3	S-BhmRe-F2 L
Song 3	S-BhmRe-F2 R
Song 3	S-BhmRe-Nz L
Song 3	S-BhmRe-Nz R
Song 3	S-BhmReFul12L
Song 3	S-BhmReFul12R
Song 3	S-BhmRe-FIt L
Song 3	S-BhmRe-FIt R
Song 3	S-BhmJp-Pf06L
Song 3	S-BhmJp-Pf06R
Song 3	S-BhmJpPffItL
Song 3	S-BhmJpPffItR
Song 3	S-BhmJpInt12L
Song 3	S-BhmJpInt12R
Song 3	S-BhmJpFul12L
Song 3	S-BhmJpFul12R

Category	Type
Song 3	S-BhmJp-Fit L
Song 3	S-BhmJp-Fit R
Song 3	S-ImgIntFit L
Song 3	S-ImgIntFit R
Song 3	S-ImgFulFit L
Song 3	S-ImgFulFit R
Song 3	S-Img-Int12 L
Song 3	S-Img-Int12 R
Song 3	S-Img-Ful12 L
Song 3	S-Img-Ful12 R
Song 3	S-ImgCd-Int L
Song 3	S-ImgCd-Int R
Song 3	S-ImgCd-Ful L
Song 3	S-ImgCd-Ful R
Song 3	S-ImgNw-Int L
Song 3	S-ImgNw-Int R
Song 3	S-ImgNw-Ful L
Song 3	S-ImgNw-Ful R
Song 3	S-ImgRe-Int L
Song 3	S-ImgRe-Int R
Song 3	S-ImgRe-Ful L
Song 3	S-ImgRe-Ful R
Song 3	S-LdyM-Int12L
Song 3	S-LdyM-Int12R
Song 3	S-LdyM-Int14L
Song 3	S-LdyM-Int14R
Song 3	S-LdyM-A12 L
Song 3	S-LdyM-A12 R
Song 3	S-LdyM-B12 L
Song 3	S-LdyM-B12 R
Song 3	S-LdyMIntFitL
Song 3	S-LdyMIntFitR
Song 3	S-LdyM-Fit L
Song 3	S-LdyM-Fit R
Song 3	S-LdyM-Ful10L
Song 3	S-LdyM-Ful10R
Song 3	S-LdyMBC-IntL
Song 3	S-LdyMBC-IntR

Category	Type
Song 3	S-LdyMBC-Full
Song 3	S-LdyMBC-FulR
Song 3	S-LdyM1c-IntL
Song 3	S-LdyM1c-IntR
Song 3	S-LdyM1c-FulL
Song 3	S-LdyM1c-FulR
Song 3	S-LdyMEdF12L
Song 3	S-LdyMEdF12R
Song 3	S-LIB-Fit L
Song 3	S-LIB-Fit R
Song 3	S-LIBBc-Int L
Song 3	S-LIBBc-Int R
Song 3	S-LIBBc-Ful L
Song 3	S-LIBBc-Ful R
Song 3	S-LIBCd-Int L
Song 3	S-LIBCd-Int R
Song 3	S-LIBCd-Ful L
Song 3	S-LIBCd-Ful R
Song 3	S-LIBmIntFitL
Song 3	S-LIBmIntFitR
Song 3	S-LIBMo-Int L
Song 3	S-LIBMo-Int R
Song 3	S-LIBMoInt16L
Song 3	S-LIBMoInt16R
Song 3	S-LIBMo-Ful L
Song 3	S-LIBMo-Ful R
Song 3	S-LIBSIntFitL
Song 3	S-LIBSIntFitR
Song 3	S-LIBStInt16L
Song 3	S-LIBStInt16R
Song 4	S-ClkCd-Int1L
Song 4	S-ClkCd-Int1R
Song 4	S-ClkCd-Int2L
Song 4	S-ClkCd-Int2R
Song 4	S-ClkCd-Ful L
Song 4	S-ClkCd-Ful R
Song 4	S-Clk-IntFitL
Song 4	S-Clk-IntFitR

Category	Type
Song 4	S-Clk-FulFitL
Song 4	S-Clk-FulFitR
Song 4	S-Clk-Flnt12L
Song 4	S-Clk-Flnt12R
Song 4	S-Clk-Full12L
Song 4	S-Clk-Full12R
Song 4	S-PfManPffitL
Song 4	S-PfManPffitR
Song 4	S-PfMan-Int L
Song 4	S-PfMan-Int R
Song 4	S-PfMan-Ful L
Song 4	S-PfMan-Ful R
Song 4	S-PfMan-Flt L
Song 4	S-PfMan-Flt R
Song 4	S-PfManInt12L
Song 4	S-PfManInt12R
Song 4	S-PfMan-Ful6L
Song 4	S-PfMan-Ful6R
Song 4	S-VInsIntRe9L
Song 4	S-VInsIntRe9R
Song 4	S-VInsCdPFitL
Song 4	S-VInsCdPFitR
Song 4	S-VInsCd-IntL
Song 4	S-VInsCd-IntR
Song 4	S-VInsCd-FulL
Song 4	S-VInsCd-FulR
Song 4	S-VInsCd-FltL
Song 4	S-VInsCd-FltR
Song 4	S-VInsRePFitL
Song 4	S-VInsRePFitR
Song 4	S-VInsRe-IntL
Song 4	S-VInsRe-IntR
Song 4	S-VInsRelnt9L
Song 4	S-VInsRelnt9R
Song 4	S-VInsRe-FulL
Song 4	S-VInsRe-FulR
Song 4	S-VInsRe-FltL
Song 4	S-VInsRe-FltR

Category	Type
Song 4	S-VInsRe-Fl6L
Song 4	S-VInsRe-Fl6R
Song 4	S-VInsReFl12L
Song 4	S-VInsReFl12R
Song 4	S-UrSgIntFitL
Song 4	S-UrSgIntFitR
Song 4	S-UrSg-Int12L
Song 4	S-UrSg-Int12R
Song 4	S-UrSg-1VFitL
Song 4	S-UrSg-1VFitR
Song 4	S-UrSg-1V06 L
Song 4	S-UrSg-1V06 R
Song 4	S-UrSgFulFitL
Song 4	S-UrSgFulFitR
Song 4	S-UrSg-Ful6 L
Song 4	S-UrSg-Ful6 R
Song 4	S-UrSg-Ful8 L
Song 4	S-UrSg-Ful8 R
Song 4	S-UrSg-Ful10L
Song 4	S-UrSg-Ful10R
Song 4	S-UrSgCd-IntL
Song 4	S-UrSgCd-IntR
Song 4	S-UrSgCd-FulL
Song 4	S-UrSgCd-FulR
Song 4	S-UrSgPs-IntL
Song 4	S-UrSgPs-IntR
Song 4	S-UrSgPs-FulL
Song 4	S-UrSgPs-FulR
Song 4	S-HTS-Pffit L
Song 4	S-HTS-Pffit R
Song 4	S-HTS-Int06 L
Song 4	S-HTS-Int06 R
Song 4	S-HTS-Int12 L
Song 4	S-HTS-Int12 R
Song 4	S-HTS-FulFitL
Song 4	S-HTS-FulFitR
Song 4	S-HTS-Full12L
Song 4	S-HTS-Full12R

Category	Type
Song 4	S-Mst-10 L
Song 4	S-Mst-10 R
Song 4	S-Mst-12 L
Song 4	S-Mst-12 R
Song 4	S-MplR1-12 L
Song 4	S-MplR1-12 R
Song 4	S-MplR2-12 L
Song 4	S-MplR2-12 R
Song 4	S-MplR3-12 L
Song 4	S-MplR3-12 R
Song 4	S-MplHi-12 L
Song 4	S-MplHi-12 R
Song 4	S-SLY-Int12 L
Song 4	S-SLY-Int12 R
Song 4	S-SLY-Ful9 L
Song 4	S-SLY-Ful9 R
Song 4	S-ThM-FulHi7L
Song 4	S-ThM-FulHi7R
Song 4	S-SLY-FulHi9L
Song 4	S-SLY-FulHi9R
Song 4	S-ThMcd-Pf9 L
Song 4	S-ThMcd-Pf9 R
Song 4	S-ThMcd-Hi10L
Song 4	S-ThMcd-Hi10R
Song 4	S-WLT-4 L
Song 4	S-WLT-4 R
Song 4	S-WLT-Hi7 L
Song 4	S-WLT-Hi7 R
Song 4	S-WLT-PfHi10L
Song 4	S-WLT-PfHi10R
Song 5	S-GrtLoveIntL
Song 5	S-GrtLoveIntR
Song 5	S-GrtLove L
Song 5	S-GrtLove R
Song 5	S-JstWay L
Song 5	S-JstWay R
Song 5	S-JstWayReInL
Song 5	S-JstWayReInR

Category	Type
Song 5	S-JstWayRe L
Song 5	S-JstWayRe R
Song 5	S-MySwtBstInL
Song 5	S-MySwtBstInR
Song 5	S-MySwtBst L
Song 5	S-MySwtBst R
Song 5	S-MySwtCdIn L
Song 5	S-MySwtCdIn R
Song 5	S-MySwtCd L
Song 5	S-MySwtCd R
Song 5	S-MySwtCpIn L
Song 5	S-MySwtCpIn R
Song 5	S-MySwtCp L
Song 5	S-MySwtCp R
Song 5	S-NtLkThsIntL
Song 5	S-NtLkThsIntR
Song 5	S-NtLkThs L
Song 5	S-NtLkThs R
Song 5	S-SvMyLovIntL
Song 5	S-SvMyLovIntR
Song 5	S-SvMyLov L
Song 5	S-SvMyLov R
Song 5	S-CzyAftIntL
Song 5	S-CzyAftIntR
Song 5	S-CzyAft L
Song 5	S-CzyAft R
Song 5	S-CzyAftReInL
Song 5	S-CzyAftReInR
Song 5	S-CzyAftRe L
Song 5	S-CzyAftRe R
Song 5	S-SumMadCdInL
Song 5	S-SumMadCdInR
Song 5	S-SumMadCd L
Song 5	S-SumMadCd R
Song 5	S-SumMadReInL
Song 5	S-SumMadReInR
Song 5	S-SumMadRe L
Song 5	S-SumMadRe R

Category	Type
Song 5	S-NoQtrUsIntL
Song 5	S-NoQtrUsIntR
Song 5	S-NoQtrUs L
Song 5	S-NoQtrUs R
Song 5	S-NoQtrJpIntL
Song 5	S-NoQtrJpIntR
Song 5	S-NoQtrJp L
Song 5	S-NoQtrJp R
Song 5	S-NoQtrReIntL
Song 5	S-NoQtrReIntR
Song 5	S-NoQtrRe L
Song 5	S-NoQtrRe R
Song 5	S-ImNtOly1InL
Song 5	S-ImNtOly1InR
Song 5	S-ImNtOly1 L
Song 5	S-ImNtOly1 R
Song 5	S-ScientstInL
Song 5	S-ScientstInR
Song 5	S-Scientst L
Song 5	S-Scientst R
Song 5	S-SkyFullStrL
Song 5	S-SkyFullStrR
Song 5	S-Som1LkIn L
Song 5	S-Som1LkIn R
Song 5	S-Som1LkInHiL
Song 5	S-Som1LkInHiR
Song 5	S-Som1Lk L
Song 5	S-Som1Lk R
Song 5	S-StayInt L
Song 5	S-StayInt R
Song 5	S-Stay L
Song 5	S-Stay R
Song 5	S-1000miln L
Song 5	S-1000miln R
Song 5	S-1000milnDwL
Song 5	S-1000milnDwR
Song 5	S-1000mi L
Song 5	S-1000mi R

Category	Type
Song 5	S-1000miUpGnL
Song 5	S-1000miUpGnR
Song 5	S-WhenLvTkInL
Song 5	S-WhenLvTkInR
Song 5	S-WhenLvTk L
Song 5	S-WhenLvTk R
Song 5	S-UArReasnInL
Song 5	S-UArReasnInR
Song 5	S-UArReasn L
Song 5	S-UArReasn R
Song 5	S-Crystal L
Song 5	S-Crystal R
Song 5	S-Matrix L
Song 5	S-Matrix R
Song 5	S-NowHeSngs L
Song 5	S-NowHeSngs R
Song 5	S-ReturnToInL
Song 5	S-ReturnToInR
Song 5	S-ReturnTo L
Song 5	S-ReturnTo R
Song 5	S-Steps L
Song 5	S-Steps R
Song 5	S-WhatGame L
Song 5	S-WhatGame R
Song 5	S-Windows L
Song 5	S-Windows R
Song 5	S-CarolineInL
Song 5	S-CarolineInR
Song 5	S-Caroline L
Song 5	S-Caroline R
Song 5	S-Dreamers L
Song 5	S-Dreamers R
Song 5	S-LogicSong L
Song 5	S-LogicSong R

Microphone Effects List

Microphone Effect Type List

Listed below are the types of microphone effects and the effects contained in each module from M1 to M3 for each type.

For more information on the effects listed in the M1 to M3 columns, see “[List of Effects in the Microphone Effects Module](#)” (page EN-227).

No.	Microphone Effect Type Name (Displayed)	M1	M2	M3
1	Powerful	Mono 3-Band EQ	Mono 3-Band EQ	Delay
2	Presence	Mono 3-Band EQ	Mono 3-Band EQ	Delay
3	Clear	Mono 3-Band EQ	Mono 3-Band EQ	Delay
4	Soft	Limiter	Mono 3-Band EQ	Delay
5	Rock	Limiter	Mono 3-Band EQ	Delay
6	Bright Enh	Enhancer	Mono 3-Band EQ	Delay
7	Presence Enh	Enhancer	Mono 3-Band EQ	Delay
8	AmbientDelay	Mono 3-Band EQ	Mono 3-Band EQ	Delay
9	Short Delay	Mono 3-Band EQ	Mono 3-Band EQ	Delay
10	Echo	Mono 3-Band EQ	Mono 3-Band EQ	Delay
11	Middle Delay	Mono 3-Band EQ	Mono 3-Band EQ	Delay
12	Long Delay	Mono 3-Band EQ	Mono 3-Band EQ	Delay
13	Pan Delay	Mono 3-Band EQ	Auto Pan	Delay
14	Chorus	Mono 3-Band EQ	Chorus	Delay
15	Phaser	Mono 3-Band EQ	Phaser	Delay
16	Deep Phaser	Mono 3-Band EQ	Phaser	Delay
17	PhaserChorus	Mono 3-Band EQ	Phaser	Chorus
18	FlangerDelay	Mono 3-Band EQ	Flanger	Delay
19	FlangerPhase	Mono 3-Band EQ	Flanger	Phaser
20	Upper Octave	Mono 3-Band EQ	PitchShifter	Delay
21	Lower Octave	Mono 3-Band EQ	PitchShifter	Delay
22	Tremolo	Mono 3-Band EQ	Tremolo	Delay
23	Vibrato	Mono 3-Band EQ	Chorus	Delay
24	Distortion	Drive	Mono 3-Band EQ	Mono 3-Band EQ
25	RingMod LoFi	Drive	Ring Modulator	Mono 3-Band EQ

List of Effects in the Microphone Effects Module

Listed below are all the effects included in the Microphone Effects module.

For details on the parameters and setting ranges that can be set for each effect, see “[Parameter List of Module Effects](#)” (page EN-228).

No.	Display	Name	Description
①	Mono 3BandEQ	Mono 3-Band EQ	This is a three-band monaural equalizer.
②	Tremolo	Tremolo	Shifts the volume of the input signal using an LFO.
③	Auto Pan	Auto Pan	Shifts the continual left-right panning of the input signal using an LFO.
④	Limiter	Limiter	Limits the input signal level so it does not rise above a preset level.
⑤	Enhancer	Enhancer	Enhances the profiles of the low range and high range of the input signal.
⑥	Phaser	Phaser	Produces a distinctive pulsating, broad sound by using an LFO to change the phase of the input signal and then mixes it with the original input signal.
⑦	Chorus	Chorus	Gives notes depth and breadth.
⑧	Flanger	Flanger	Applies wildly pulsating and metallic reverberation to notes. Selects the LFO waveform.
⑨	Pitch	PitchShifter	This effect transforms the pitch of the input signal.
⑩	Ring Mod	Ring Modulator	Multiplies the input signal with an internal oscillator signal to create a metallic sound.
⑪	Delay	Delay	Delays the input signal and feeds it back to create a repeating effect.
⑫	Drive	Drive	Simulates the drive of a musical instrument amplifier.

Parameter List of Module Effects

Effect		Description	Settings
Display	Parameter Name		
① Mono 3-Band EQ		This is a three-band monaural equalizer.	
EQ1 Freq	EQ1 Frequency	Adjusts the center frequency of Equalizer 1.	*1
EQ1 Gain	EQ1 Gain	Adjusts the gain of Equalizer 1.	-12 - 00 - 12
EQ2 Freq	EQ2 Frequency	Adjusts the center frequency of Equalizer 2.	*1
EQ2 Gain	EQ2 Gain	Adjusts the gain of Equalizer 2.	-12 - 00 - 12
EQ3 Freq	EQ3 Frequency	Adjusts the center frequency of Equalizer 3.	*1
EQ3 Gain	EQ3 Gain	Adjusts the gain of Equalizer 3.	-12 - 00 - 12
Input Level	Input Level	Adjusts the input level.	000 - 127
Wet Level	Wet Level	Adjusts the level of the effect sound.	000 - 127
Dry Level	Dry Level	Adjusts the level of the direct sound.	000 - 127
② Tremolo		Shifts the volume of the input signal using an LFO.	
Rate	LFO Rate	Adjusts the LFO rate.	000 - 127
Depth	LFO Depth	Adjusts the LFO depth.	000 - 127
Waveform	LFO Waveform	Selects the LFO waveform.	Sine, Triangle, Trapezoid
Wet Level	Wet Level	Adjusts the level of the effect sound.	000 - 127
Dry Level	Dry Level	Adjusts the level of the direct sound.	000 - 127
③ Auto Pan		Shifts the continual left-right panning of the input signal using an LFO.	
Rate	LFO Rate	Adjusts the LFO rate.	000 - 127
Depth	LFO Depth	Adjusts the LFO depth.	000 - 127
Waveform	LFO Waveform	Selects the LFO waveform.	Sine, Triangle, Trapezoid 1, Trapezoid 2, Trapezoid 3, Trapezoid 4
Manual	Manual	Adjusts the pan (stereo position). -64 is full left, 0 is center, and +63 is full right.	-64 - 00 - 63
Wet Level	Wet Level	Adjusts the level of the effect sound.	000 - 127
Dry Level	Dry Level	Adjusts the level of the direct sound.	000 - 127

Effect		Description	Settings
Display	Parameter Name		
④ Limiter		Limits the input signal level so it does not rise above a preset level.	
Limit	Limit	Adjusts the volume level of the limit at which limiting is applied.	000 - 127
Attack	Attack	Adjusts the time until the compression effect starts. A smaller value causes prompt limiter operation, which suppresses the attack of the input signal. A larger values delays limiter operation, which causes the attack of the input signal to be output as-is.	000 - 127
Release	Release	Adjusts the time until compression is released after the input signal drops below a prescribed level.	000 - 127
Wet Level	Wet Level	Adjusts the level of the effect sound. Output volume changes in accordance with the Limit setting and the characteristics of the input tone. Use this parameter to correct for such changes.	000 - 127
Dry Level	Dry Level	Adjusts the level of the direct sound.	000 - 127
⑤ Enhancer		Enhances the profiles of the low range and high range of the input signal.	
Low Freq	Low Frequency	Adjusts the low range enhancer frequency.	000 - 127
Low Gain	Low Gain	Adjusts the low range enhancer gain.	000 - 127
High Freq	High Frequency	Adjusts the high range enhancer frequency.	000 - 127
High Gain	High Gain	Adjusts the high range enhancer gain.	000 - 127
Input Level	Input Level	Adjusts the input level.	000 - 127
Wet Level	Wet Level	Adjusts the level of the effect sound.	000 - 127
Dry Level	Dry Level	Adjusts the level of the direct sound.	000 - 127
⑥ Phaser		Produces a distinctive pulsating, broad sound by using an LFO to change the phase of the input signal and then mixes it with the original input signal.	
Resonance	Resonance	Adjusts the strength of feedback.	000 - 127
Manual	Manual	Adjusts the reference phaser shift amount.	-64 - 00 - 63
Rate	LFO Rate	Adjusts the LFO rate.	000 - 127
Depth	LFO Depth	Adjusts the LFO depth.	000 - 127
Waveform	LFO Waveform	Selects the LFO waveform.	Sine, Triangle, Random
Input Level	Input Level	Adjusts the input level.	000 - 127
Wet Level	Wet Level	Adjusts the level of the effect sound.	000 - 127
Dry Level	Dry Level	Adjusts the level of the direct sound.	000 - 127

Effect		Description	Settings
Display	Parameter Name		
⑦ Chorus		Gives notes depth and breadth.	
Rate	LFO Rate	Adjusts the LFO rate.	000 - 127
Depth	LFO Depth	Adjusts the LFO depth.	000 - 127
Waveform	LFO Waveform	Selects the LFO waveform.	Sine, Triangle
Feedback	Feedback	Adjusts the strength of feedback.	-64 - 00 - 63
Wet Level	Wet Level	Adjusts the level of the effect sound.	000 - 127
Polarity	Polarity	Inverts the LFO of one channel.	Negative, Positive
Input Level	Input Level	Adjusts the input level.	000 - 127
Dry Level	Dry Level	Adjusts the level of the direct sound.	000 - 127
⑧ Flanger		Applies wildly pulsating and metallic reverberation to notes. Selects the LFO waveform.	
Rate	LFO Rate	Adjusts the LFO rate.	000 - 127
Depth	LFO Depth	Adjusts the LFO depth.	000 - 127
Waveform	LFO Waveform	Selects the LFO waveform.	Sine, Triangle, Random
Feedback	Feedback	Adjusts the strength of feedback.	-64 - 00 - 63
Wet Level	Wet Level	Adjusts the level of the effect sound.	000 - 127
Input Level	Input Level	Adjusts the input level.	000 - 127
Dry Level	Dry Level	Adjusts the level of the direct sound.	000 - 127
⑨ PitchShifter		This effect transforms the pitch of the input signal.	
PitchQuarter	PitchQuarter	Adjusts the pitch shift amount in quarter tone steps.	-24 - 00 - 24
High Damp	High Damp	Adjusts the high-range damp. A smaller number increases damping.	000 - 127
Feedback	Feedback	Adjusts the feedback amount.	000 - 127
Input Level	Input Level	Adjusts the input level.	000 - 127
Wet Level	Wet Level	Adjusts the level of the effect sound.	000 - 127
Dry Level	Dry Level	Adjusts the level of the direct sound.	000 - 127
Pitch Fine	Pitch Fine	Adjusts the pitch shift amount. -50 is a quarter note decrease, while +50 is a quarter note increase.	-50 - 00 - 50

Effect		Description	Settings
Display	Parameter Name		
⑩ Ring Modulator		Multiplies the input signal with an internal oscillator signal to create a metallic sound.	
OSC Freq	OSC Frequency	Sets the reference frequency of the internal oscillator.	000 - 127
Rate	LFO Rate	Adjusts the LFO rate.	000 - 127
Depth	LFO Depth	Adjusts the LFO depth.	000 - 127
Tone	Tone	Adjusts the timbre of the ring modulator input sound.	000 - 127
Wet Level	Wet Level	Adjusts the level of the effect sound.	000 - 127
Dry Level	Dry Level	Adjusts the level of the direct sound.	000 - 127
⑪ Delay		Delays the input signal and feeds it back to create a repeating effect.	
Time	Delay Time	Adjusts the total delay time in 1 ms units.	0001 - 1099
L.Time Ratio	Delay Ratio L	Adjusts the ratio of the left channel relative to the total delay time.	000 - 127
R.Time Ratio	Delay Ratio R	Adjusts the ratio of the right channel relative to the total delay time.	000 - 127
L.Level	Delay Level L	Adjusts the level of the left channel.	000 - 127
R.Level	Delay Level R	Adjusts the level of the right channel.	000 - 127
FeedbackType	Feedback Type	Selects the feedback type. Stereo: Stereo feedback Cross: Cross feedback	Stereo, Cross
Feedback Lvl	Feedback	Adjusts the feedback amount.	000 - 127
High Damp	High Damp	Adjusts the high-range damp. A smaller number increases damping.	000 - 127
Tmpo Sync	Delay Tempo Sync	Specifies how the actual total delay time is synced with tempo. Off: Uses Delay Time value. 1/4 to 1: Uses value in accordance with number of beats.	Off, 1/4, 1/3, 3/8, 1/2, 2/3, 3/4, 1
Input Level	Input Level	Adjusts the input level.	000 - 127
Dry Level	Dry Level	Adjusts the level of the direct sound.	000 - 127
Wet Level	Wet Level	Adjusts the level of the effect sound.	000 - 127

Effect		Description	Settings
Display	Parameter Name		
⑫ Drive		Simulates the drive of a musical instrument amplifier.	
Type	Drive Type	Selects the drive type.*2	1 - 20
Gain	Gain	Adjusts the driver input signal gain.	000 - 127
Output Level	Level	Adjusts the drive output level.	000 - 127
Wet Level	Wet Level	Adjusts the level of the effect sound.	000 - 127
Dry Level	Dry Level	Adjusts the level of the direct sound.	000 - 127

*1 100Hz, 125Hz, 160Hz, 200Hz, 250Hz, 315Hz, 400Hz, 500Hz, 630Hz, 800Hz, 1.0kHz, 1.3kHz, 1.6kHz, 2.0kHz, 2.5kHz, 3.2kHz, 4.0kHz, 5.0kHz, 6.3kHz, 8.0kHz

*2

Settings	Drive Type	Display	Description
1 - 4	Clean1 - 4	Clean 1 - 4	Simulates a clean sound with little distortion.
5 - 8	Crunch1 - 4	Crunch 1 - 4	Simulates a crisp crunch sound with little distortion.
9 - 12	Overdrive1 - 4	Overdrive 1 - 4	Simulates an overdrive sound with mellow distortion.
13 - 16	Distortion1 - 4	Distort 1 - 4	Simulates a hard, straight distortion sound.
17 - 20	Metal1 - 4	Metal 1 - 4	Simulates an extreme and weighty distortion sound that is suitable for heavy metal music.

Arpeggiator List

Listed below are the Arpeggiator patterns. When the “Recommended Setup” is “On”, when the Arpeggiator is switched from off to on, or when “Pattern” is switched while the Arpeggiator is on, the “Recommended Setup” listed are automatically applied.

No.	Pattern Name (Pattern)	Recommended Setup					Remarks
		The Arpeggiator's target part			Split Point sound name*1	Arpeggio Hold	
		Upper 1	Upper 2	Lower			
01	Piano Sequence 1	✓			F#3		*2
02	Piano Sequence 2			✓	C5	✓	*2
03	Piano Sequence 3		✓		F#3	✓	*2
04	Piano Sequence 4		✓		F#3	✓	*2
05	Piano Sequence 5	✓			F#3		
06	Piano Triplet Sequence	✓			F#3		*2
07	Piano Odd Sequence	✓			F#3	✓	*2
08	Chordal Phrase 1	✓			F#3	✓	
09	Chordal Phrase 2		✓		F#3	✓	*2
10	Chordal Phrase 3		✓		F#3	✓	*2
11	Ambient FX 1	✓			F#3	✓	*2
12	Ambient FX 2	✓			F#3	✓	*2
13	Single Note Sequence		✓		F#3		
14	Lower EP Phrase			✓	C3	✓	
15	Layered EP Phrase		✓		F#3	✓	
16	Layered EP Arpeggio		✓		F#3	✓	
17	Layered Arpeggio 1		✓		F#3	✓	
18	Layered Arpeggio 2		✓		F#3	✓	*2
19	Layered Arpeggio 3		✓		F#3	✓	*2
20	Layered Arpeggio 4		✓		F#3	✓	
21	Synth Sequence	✓			F#2	✓	
22	Lower Strings Phrase			✓	C3	✓	
23	Walking Bass			✓	C3	✓	
24	Simple Bass			✓	C3	✓	
25	Odd Phrase Bass			✓	C3	✓	
26	Latin Piano	✓	✓		F#3	✓	
27	Screw Up	✓	✓		F#3		
28	Screw Down	✓	✓		F#3		
29	Skip Up	✓	✓		F#3		
30	Skip Down	✓	✓		F#3		

No.	Pattern Name (Pattern)	Recommended Setup					Remarks
		The Arpeggiator's target part			Split Point sound name* ¹	Arpeggio Hold	
		Upper 1	Upper 2	Lower			
31	Up Up Down	✓	✓		F#3		
32	Down Down Up	✓	✓		F#3		
33	Sequence Line 1	✓	✓		F#3		
34	Sequence Line 2	✓	✓		F#3		
35	Sequence Line 3	✓	✓		F#3		
36	Arpeggio 2Octave	✓	✓		F#3		*2
37	9th Arpeggio	✓	✓		F#3		
38	Ragtime	✓	✓		F#3		
39	8 Beat	✓			F#3		
40	12/8	✓	✓		F#3		
41	Waltz	✓	✓		F#3		
42	Shuffle Pop	✓			F#3	✓	*2
43	Up 1Octave 1	✓	✓		F#3		
44	Up 2Octave 1	✓	✓		F#3		
45	Up 1Octave 2	✓	✓		F#3		
46	Up 2Octave 2	✓	✓		F#3		
47	Down 1Octave 1	✓	✓		F#3		
48	Down 2Octave 1	✓	✓		F#3		
49	Down 1Octave 2	✓	✓		F#3		
50	Down 2Octave 2	✓	✓		F#3		

*1 When "Recommended Setup" is "On", the Split Point is automatically set to the keyboard key in this row when switching patterns. Therefore, the key range in which the Arpeggiator is reproduced varies with the pattern.

*2 These patterns have the appropriate sustain effect added to the notes played by the Arpeggiator.

MIDI Implementation Chart

Function		Transmitted	Recognized	Remarks
Basic Channel	Default	1	1 - 16	
	Changed	1 - 16	1 - 16	
Mode	Default	Mode 3	Mode 3	
	Messages Altered	X * * * * *	X * * * * *	
Note Number		0 - 127	0 - 127	
	True voice	* * * * *	0 - 127*1	
Velocity	Note ON	○ 9nH v = 1 - 127	○ 9nH v = 1 - 127	
	Note OFF	○ 8nH v = 0 - 127	○ 9nH v = 0, 8nH v = 0 - 127	
After Touch	Key's	X	X	
	Ch's	X	○	
Pitch Bender		○	○	
Control Change	0, 32	○	○	Bank select LSB/MSB Modulation Portamento time Data entry LSB/MSB Volume Pan Expression Hold 1 Portamento switch Sostenuto Soft pedal Filter resonance Release time Attack time Brightness Vibrato rate Vibrato depth Vibrato delay Portamento control High resolution velocity prefix Reverb send level Chorus send level Delay send level RPN LSB/MSB
	1	○	○	
	5	○	○	
	6, 38	○*3	○*3	
	7	○	○	
	10	○	○	
	11	○	○	
	64	○*2	○	
	65	○	○	
	66	○	○	
	67	○*2	○	
	71	○	○	
	72	○	○	
	73	○	○	
	74	○	○	
	76	○	○	
77	○	○		
78	○	○		
84	○	○		
88	○	○		
91	○*4	○		
93	○	○		
94	○	○		
100, 101	○*3	○*3		
Program Change	True #	○	○	
		* * * * *	0 - 127	
Exclusive		○*3	○*3	
System Common	Song Pos	X	X	
	Song Sel	X	X	
	Tune	X	X	
System Real Time	Clock	X	X	
	Commands	X	X	
Aux Messages	All sound off	X	○	
	Reset all controller	X	○	
	Local ON/OFF	X	X	
	All notes OFF	X	○	
	Active Sense	X	○	
	System Reset	X	X	
Remarks		*1: Depends on tone. *2: Depends on the setup of the pedal connected to the EXPRESSION/ASSIGNABLE jack. *3: For details about RPN and system exclusive messages, see MIDI Implementation at https://support.casio.com/global/en/emi/manual/PX-S6000/ *4: Depends on the knobs and the CONTROL button settings. • The MIDI messages marked with "x" in the "Transmitted" column of the above chart may be output along with certain operations.		

Mode 1 : OMNI ON, POLY
Mode 3 : OMNI OFF, POLY

Mode 2 : OMNI ON, MONO
Mode 4 : OMNI OFF, MONO

○ : Yes
X : No

CASIO®

CASIO COMPUTER CO., LTD.

6-2, Hon-machi 1-chome
Shibuya-ku, Tokyo 151-8543, Japan

PXS6000-E-2B

MA2311-B

© 2022 CASIO COMPUTER CO., LTD.