



EN

CDP-S90

CASIO

Quick Start Guide

Please keep all information for future reference.
Be sure to read the separate "Safety Precautions" and use the Digital Piano correctly.

These instructions provide general information about Digital Piano operations. For more detailed information, refer to the User's Guide available on the CASIO website, which you can access using the nearby QR code or the URL below.
<https://support.casio.com/global/en/em/manual/CDP-S90/>



Supported Operations

✓ A choice of different tones

Select from among 10 different tones, including grand piano and more. You can even layer two different tones for simultaneous play.
* THESE INSTRUCTIONS: Selecting a Tone

✓ Metronome

The metronome can be used to help maintain the correct tempo. You can select from among nine different time signatures for the metronome.
* THESE INSTRUCTIONS: Using the Metronome

✓ Play along with sound data from an externally connected device

A portable audio player or other device can be connected to the Digital Piano's AUDIO IN jack for play along with device playback on the keyboard.
* THESE INSTRUCTIONS: Playing an External Device from the Digital Piano

✓ Smart device linking for enhanced function

Digital Piano function can be controlled from the screen of a linked smart device and more.
* THESE INSTRUCTIONS: Linking with a Smart Device (APP Function)

✓ Other useful features

- Changing the Keyboard Touch Response
- Tone effects
- Changing the Pitch in Semitone Steps (Transpose)
- Fine Tuning a Pitch (Tuning)
- Computer connectivity for MIDI data exchange

* CASIO WEBSITE: User's Guide

✓ Troubleshooting

* CASIO WEBSITE: User's Guide

General Guide

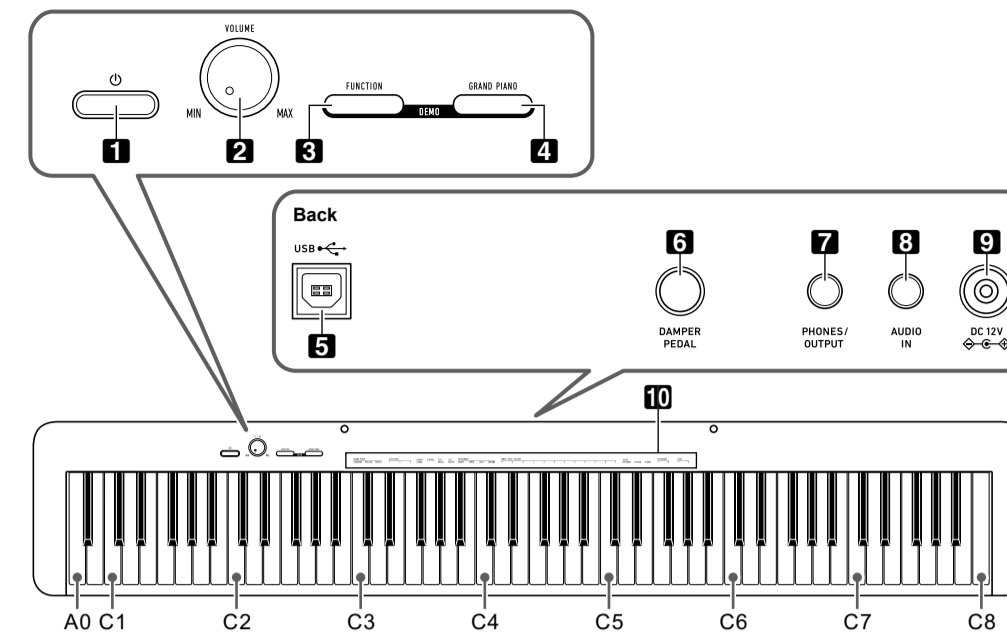

1 (Power) button

2 VOLUME knob

3 FUNCTION button

4 GRAND PIANO button

5 USB port

6 DAMPER PEDAL jack

7 PHONES/OUTPUT jack

8 AUDIO IN jack

9 DC 12V terminal

10 Functions assigned to keys*

* Functions assigned to keys

While holding down the **3 FUNCTION** button, you can use these keys to change settings, such as the currently selected tone, etc. Most of the functions that can be changed using keyboard keys are marked above the keyboard. For example, tone names assigned to the TONE setting keys (C3 to A3) are marked above the keys.

■ Preparing the Music Stand

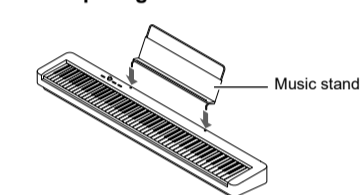

■ Returning the Digital Piano to Its Factory Default Settings

Refer to "Returning the Digital Piano to Its Factory Default Settings" on the back of these instructions.

Keyboard Function List

Note name	Assigned function (marked above the keyboard key)
C3	Standard (STANDARD)
C#3	Mellow (MELLOW)
D3	Bright (BRIGHT)
E#3	1
E3	2
F3	3
F#3	Harpischord (HARPSICHORD)
G3	Strings (STRINGS)
A#3	Pipe Organ (PIPE ORGAN)
A3	Jazz Organ (JAZZ ORGAN)
B#3	Metronome (METRONOME)
B3	On/Off (ON/OFF)
C4	Tempo (TEMPO)
C#4	Beat (BEAT)
D4	Volume (VOLUME)
E#4	-
E4	+
F4	0
F#4	1
G4	2
A#4	3
A4	4
B#4	5
B4	6
C5	7
C#5	8
D5	9
E#5	Touch Response (TOUCH RESPONSE)
E5	Reverb (REVERB)
F5	Chorus (CHORUS)
F#5	Transpose (TRANPOSE)
G5	-
A#5	+
A5	Tune (TUNE)
G6	Keyboard Channel
A6	Local Control
B6	Auto Power Off
E7	Factory Reset
G7	Execute
B7	Beep

* * CASIO WEBSITE: User's Guide

Keyboard note names and pitches

The keyboard note names and pitches used in these instructions follow the international standard. Middle C is C4, the lowest C is C1, and the highest C is C8. The illustration below (C4 through C5) shows keyboard key note names.

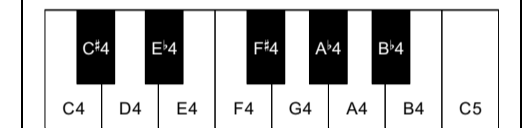

Included Accessories

- Music Stand
- AC adaptor
- Power cord
- Pedal
- Leaflets
 - Safety Precautions
 - Other (Warranty, etc.)

Items included as accessories are subject to change without notice.

Separately Available Accessories

You can get information about accessories that are separately for this product from the CASIO catalog available from your retailer, and from the CASIO website at the URL below.
<https://support.casio.com/global/en/em/manual/CDP-S90/>



Getting Ready

Preparing a Power Supply

■ Using the AC Adaptor

Make sure that you use only the AC adaptor specified for this Digital Piano. Use of a different type of AC adaptor can cause malfunction.

Specified AC Adaptor: AD-A12150LW (JEITA Standard plug)

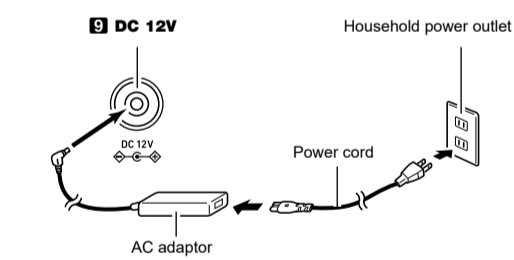

IMPORTANT!

- Never connect the AC adaptor (JEITA Standard, with unified polarity plug) that comes with this Digital Piano to any other device besides this Digital Piano. Doing so creates the risk of malfunction.
- Be sure to turn off Digital Piano power before connecting or disconnecting the AC adaptor.
- The AC adaptor will become warm to the touch after very long use. This is normal and does not indicate malfunction.

■ Using Batteries

IMPORTANT!

- Be sure to turn off power before loading batteries.
 - It is up to you to prepare six commercially available batteries. Do not use oxyride batteries or any other nickel based batteries.
 - Note the precautions below while the Digital Piano is turned upside down to load batteries.
 - Take care to avoid injury due to pinching your fingers under the Digital Piano.
 - Do not allow the Digital Piano to tip over or otherwise be subjected to strong impact. Impact can damage the volume knob and keyboard keys.
1. Open the battery cover on the bottom of the Digital Piano.
 2. Load six AA-size batteries into the battery compartment. Make sure the positive (+) and negative (-) ends of the batteries are facing as marked on the Digital Piano.
 3. Insert the tabs of the battery cover into the holes along the side of the battery compartment, and close the cover.

■ Low Battery Indication

Low batteries are indicated by the **1 (Power)** button lamp flashing. When this happens, replace batteries.

IMPORTANT!

- Continued use with low batteries will cause Digital Piano power to turn off automatically. This can cause data stored in Digital Piano memory to be corrupted or lost.

Connecting a Pedal

Connecting the supplied pedal (SP-3) to the **6 DAMPER PEDAL** jack makes it possible to use the pedal as a damper pedal. Pressing the damper pedal while playing will cause the notes you play to reverberate.

Back

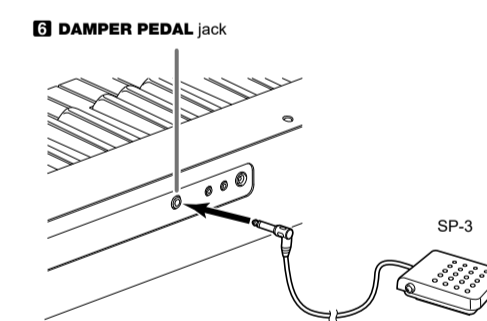

Using Headphones

Using headphones cuts off output from the built-in speakers, which means you can practice playing even late at night without disturbing others.

- Be sure to turn down the volume level before connecting headphones.

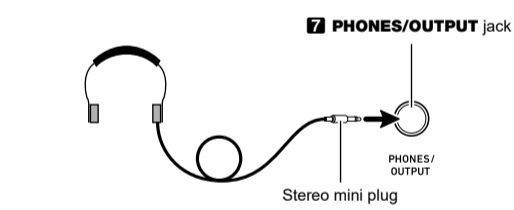

NOTE

- Headphones do not come with the Digital Piano.
- Use commercially available headphones. See "Separately Available Accessories" for information about options.

IMPORTANT!

- Do not listen to very high volume output over headphones for long period. Doing so creates the risk of hearing damage.
- If you are using headphones that require an adaptor plug, make sure you do not leave the adaptor plugged in when you unplug the headphones. If you do, nothing will sound from the speakers when you play.

Turning Power On or Off

1. Press the **1 (Power)** button to turn on Digital Piano power.

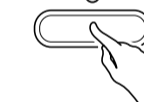

2. To turn off the Digital Piano, hold down the **1 (Power)** button until the power lamp goes out.

NOTE

- Pressing the **1 (Power)** button to turn off power actually puts the Digital Piano into a standby state. Minute amounts of current continue to flow within the Digital Piano in the standby state. If you do not plan to use the Digital Piano for a long time or if there is a lightning storm in your area, be sure to unplug the AC adaptor from the power outlet.
- Turning off power causes the Digital Piano settings to return to their initial defaults. The tuning setting, however, is retained.

Auto Power Off

This Digital Piano is designed to turn off automatically to avoid wasting power after no operation is performed for a preset amount of time. The Auto Power Off trigger time is about four hours when power is being supplied by the AC adaptor, or six minutes under battery power.

■ To enable or disable Auto Power Off

- If you don't know what keyboard keys are required to perform a desired operation, refer to the "Keyboard Function List" in these instructions.
1. While holding down **3 FUNCTION**, press the **B6 (Auto Power Off)** keyboard key.
 - Each press of the B6 keyboard key causes a short beep to sound. A low beep sounds when Auto Power Off is disabled, and a high beep sounds when it is enabled.

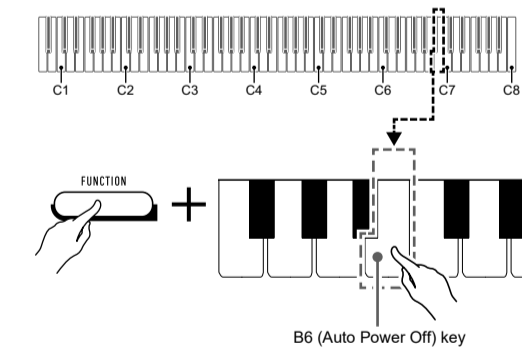

2. After the setting is the way you want, release **3 FUNCTION**.

Adjusting Volume

Use the **2 VOLUME** knob to adjust the volume of speaker and headphone output.

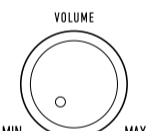

Selecting a Tone

The Digital Piano has 10 built-in tones. In addition to using a single tone, you can also select two different tones and sound them together.

Selecting the GRAND PIANO STANDARD Tone

Press **[4] GRAND PIANO**. This causes the button lamp to light.



To select a single tone

- While holding down **[3] FUNCTION**, press one of the **Tone** keyboard keys (C3 through A3).

- To select HARPSICHORD, for example, hold down **[3] FUNCTION** and press the HARPSICHORD keyboard key (F#3). A short beep will sound to confirm the setting.

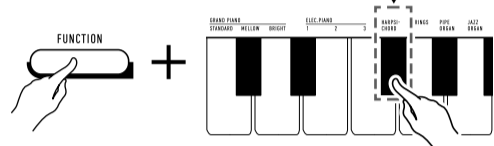
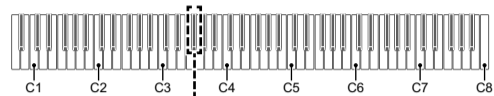

- Release **[3] FUNCTION**.

To layer two tones

- While holding down **[3] FUNCTION**, press the **Tone** keyboard keys (C3 through A3) of the first tone and then the second tone you want to layer.

- To layer HARPSICHORD and STRINGS, for example, hold down **[3] FUNCTION** and press the HARPSICHORD keyboard key (F#3), and then the STRINGS key (G3).

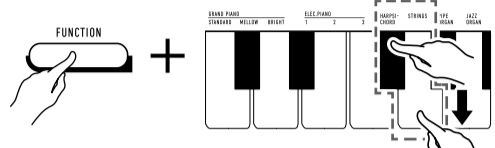
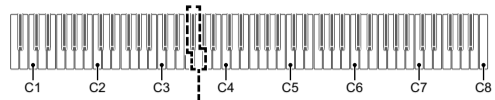

- Pressing the first keyboard key for the first tone will cause a short beep to sound, and press the key for the second tone will cause a short and then long beep to sound, indicating that the tones whose keys you pressed have been layered.

- Release **[3] FUNCTION**.

- Now pressing a single keyboard key will sound both the HARPSICHORD and STRINGS tones at the same time.

- To cancel tone layering, perform the procedure under "To select a single tone". Or you could press **[4] GRAND PIANO**, which changes the keyboard tone to GRAND PIANO STANDARD only.

Tone List

Tone Name	Program Change	Bank Select MSB
GRAND PIANO STANDARD	0	0
GRAND PIANO MELLOW	1	0
GRAND PIANO BRIGHT	2	0
ELEC.PIANO 1	3	0
ELEC.PIANO 2	4	0
ELEC.PIANO 3	5	0
HARPSICHORD	6	0
STRINGS	7	0
PIPE ORGAN	8	0
JAZZ ORGAN	9	0

Listening to Demo Play

- Press **[3] FUNCTION** and **[4] GRAND PIANO** at the same time.



This starts playback of the two demo songs.

- To stop demo song play, press **[3] FUNCTION** or **[4] GRAND PIANO**.

Demo Song List

Song No.	Song Name	Tone Name
1	Prélude [Suite bergamasque]	GRAND PIANO STANDARD
2	Original	ELEC.PIANO 1

Using the Metronome

The metronome sounds a regular tone to mark time. Use the metronome when you want to practice playing at a regular tempo.

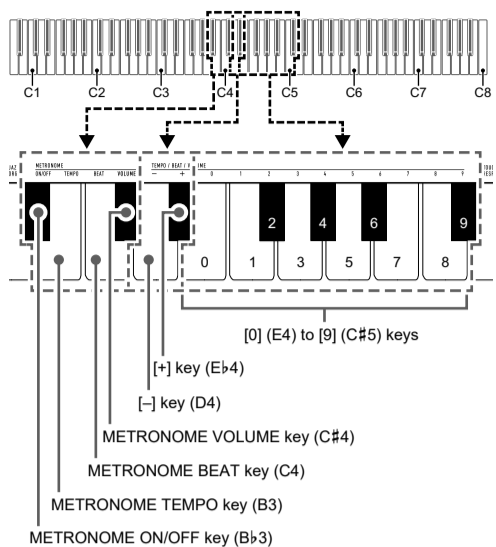

To start or stop the metronome

- While holding down **[3] FUNCTION**, press the **METRONOME ON/OFF** keyboard key (**B3**).

To change the metronome beat

- While holding down **[3] FUNCTION**, perform steps (1) and (2) below.
 - Press the **METRONOME BEAT** keyboard key (C4).
 - Press a keyboard key within the range of [0] (E4) to [9] (C#5) to specify the beat you want.

Setting	Description
0	All beats unaccented.
1	All beats accented.
2-9	Specifies beats per measure value from 2 to 9 (Default: 4). An accent sounds on the first beat only.

- To return to the initial default setting, hold down the keyboard **[+] (E#4)** and **[-] (D4)** keys at the same time until a long beep sounds.

- Release **[3] FUNCTION**.

To change the metronome tempo

- You can specify a metronome tempo in the range of 20 to 255 beats per minute (bpm). Always input three digits. To specify a two-digit value, input zero (0) for the unused leading digit.

- While holding down **[3] FUNCTION**, perform steps (1) and (2) below.

- Press the **METRONOME TEMPO** keyboard key (B3).

- Use the [0] (E4) through [9] (C#5) keyboard keys to input the three-digit tempo value.

For example, to specify a tempo of 80 bpm, press keyboard keys in the following sequence: [0] (E4) → [8] (C5) → [0] (E4). Inputting the third and final digit will cause a short and then long beep to sound, indicating that the value you input was applied.

- You can also raise or lower the tempo by pressing the keyboard **[+] (E#4)** or **[-] (D4)** key.

- To return to the initial default setting (120 bpm), hold down the keyboard **[+] (E#4)** and **[-] (D4)** keys at the same time until a long beep sounds.

- Release **[3] FUNCTION**.

To adjust the metronome volume

NOTE

- You can adjust the metronome value within the range of 0 (muted) and 42 (maximum). Always input two digits. To specify a one-digit value, input zero (0) for the unused leading digit.

- While holding down **[3] FUNCTION**, perform steps (1) and (2) below.

- Press the **METRONOME VOLUME** keyboard key (C#4).

Use the [0] (E4) through [9] (C#5) keyboard keys to input a two-digit volume value. For example, to specify a volume value of 8, press keyboard keys in the following sequence: [0] (E4) → [8] (C5). Inputting the second and final digit will cause a short and then long beep to sound, indicating that the value you input was applied.

- You can also raise or lower the volume by pressing the keyboard **[+] (E#4)** or **[-] (D4)** key.

- To return to the initial default setting (36), hold down the keyboard **[+] (E#4)** and **[-] (D4)** keys at the same time until a long beep sounds.

- Release **[3] FUNCTION**.

Playing an External Device from the Digital Piano

Connection requires commercially available connecting cords, supplied by you.

- The connecting cords should have a stereo mini plug on one end and a plug that matches the configuration of the external device on the other end.

IMPORTANT!

- Turn off the Digital Piano when making connections. After connecting, turn down the Digital Piano and external device volume levels whenever turning power on or off.
- After connecting, turn on the external device and then the Digital Piano.
- If external device notes that sound through the Digital Piano speakers are distorted, lower the external device's volume level setting.

Digital Piano **[3] AUDIO IN** jack

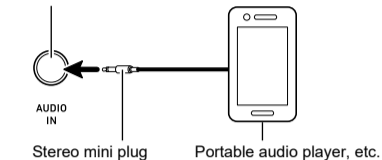

Returning the Digital Piano to Its Factory Default Settings

Perform the procedure below when you want to return the Digital Piano's stored data and settings to their initial factory defaults.

- If you don't know what keyboard keys are required to perform a desired operation, refer to the "Keyboard Function List" in these instructions.

- While holding down **[3] FUNCTION**, perform steps (1) and (2) below.

- Press the **E7 (Factory Reset)** keyboard key.
 - This will cause a short beep to sound.
 - Performing step (2) below will initialize the Digital Piano and return it to its factory default settings. If you want to cancel initialization at this point, release **[3] FUNCTION**.
- Press the **G7 (Execute)** keyboard key.

- This causes a short and then long beep to sound, indicating that the operation is complete and that initialization has started.
- The initialization operations takes some time to complete.
- After settings are returned to their initial factory defaults, Digital Piano power will turn off automatically.

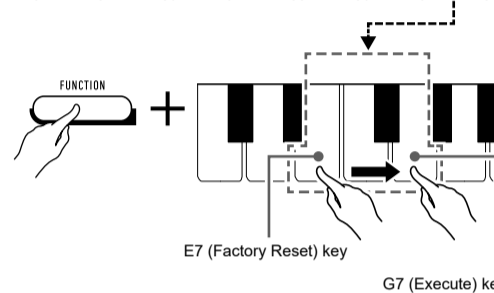
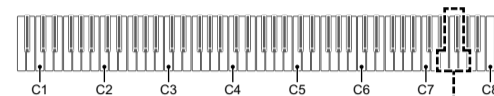

- Release **[3] FUNCTION**.

Product Specifications

Model: CDP-S90BK
Keyboard: 88-key piano keyboard, with Touch Response
Maximum Polyphony: 64 notes
Tones: 10, Layer
Effects: Reverb (4 types), Chorus (4 types)
Metronome:
 • Beat bell: 0 (Off), 1 to 9 (beats)
 • Tempo Range: 20 to 255

Demo Songs: 2
Pedals: Damper
Other Functions:

- Touch Response: 3 types, Off
- Transpose: 2 octaves (-12 to 0 to 12 semitones)
- Tuning: A4 = 415.5 Hz to 465.9 Hz (Initial Default: 440.0 Hz), variable in 0.1 Hz steps

MIDI: 16-channel multi-timbre receive

Inputs/Outputs:

- PHONES/OUTPUT jack: Stereo mini jack (Output Voltage: 1.2V (RMS) MAX)
- Power: 12V DC
- AUDIO IN jack: Stereo mini jack (Input impedance: 10kΩ, Input voltage: 200mV)
- USB port: TYPE B
- DAMPER PEDAL jack: Standard jack

Speakers: 12cm × 6cm (Oval) × 2 (Output 8W + 8W)

Power Supply: 2-way

- Batteries: 6 AA-size alkaline batteries
- Battery Life: Approximately 13 hours continuous operation on alkaline batteries
- AC Adaptor: AD-A12150LW
- Auto Power Off: Approximately 4 hours (AC Adaptor) / 6 minutes (batteries) after last operation; can be disabled.

Power Consumption: 12V --- 8W

Dimensions: 132.2 (W) × 23.2 (D) × 9.9 (H) cm (52 1/16 × 9 1/8 × 3 7/8 inch)

Weight: Approximately 10.5kg (23.1 lbs) (without batteries)

- Specifications and designs are subject to change without notice.

Linking with a Smart Device (APP Function)

After you link the Digital Piano with a smartphone, tablet, or other smart device, you can control the Digital Piano with the linked smart device (Piano Remote Controller).

To download the smart device app

Download the Chordana Play for Piano app from the CASIO website and install it on the smart device.

<https://support.casio.com/global/en/emi/manual/CDP-S90/>



To link to a smart device

After installing the Chordana Play for Piano app on a smart device, use a commercially available USB cable to connect the smart device's USB port with the Digital Piano's USB port. After connecting the smart device to the Digital Piano, use the smart device app to perform operations. For details about operations, refer to the user documentation of the app.

Operating Precautions

Be sure to read and observe the following operating precautions.

Location

Avoid the following locations for this product.

- Areas exposed to direct sunlight and high humidity
 - Areas subjected to temperature extremes
 - Near a radio, TV, video deck, or tuner
- The above devices will not cause malfunction of the product, but the product can cause interference in the audio or video of a nearby device.

User Maintenance

- Never use benzene, alcohol, thinner, or other chemical agents to clean the product.
- To clean the product or its keyboard, wipe with a soft cloth moistened in a weak solution of water and a mild neutral detergent. Wring all excess moisture from the cloth before wiping.

Included and Optional Accessories

Use only accessories that are specified for use with this product. Use of unauthorized accessories creates the risk of fire, electric shock, and personal injury.

Weld Lines

Lines may be visible on the exterior of the product. These are "weld lines" that result from the plastic molding process. They are not cracks or scratches.

Musical Instrument Etiquette

Always be aware of others around you whenever using this product. Be especially careful when playing late at night to keep the volume at levels that do not disturb others. Other steps you can take when playing late at night are closing the window and using headphones.

AC Adaptor Handling Precautions

- Never insert metal, pencils, or any other objects into the product's DC12V terminal. Doing so creates the risk of accident.
- Do not try to use the power cord that comes with the product with another device.
- Use a power outlet that is easily accessible so you can unplug the AC adaptor when a malfunction occurs or whenever else you need to do so.
- The AC adaptor is intended for indoor use only. Do not use it where it might be exposed to splashing or moisture. Do not place any container, such as a flower vase, that contains liquid on the AC adaptor.
- Never cover the AC adaptor with newspaper, a table cloth, a curtain, or any other similar item.
- Unplug the AC adaptor from the power outlet if you do not plan to use the Digital Piano for a long time.
- The AC adaptor cannot be repaired. If your AC adaptor malfunctions or becomes damaged, you need to purchase a new one.
- AC adaptor operating environment
 - Temperature: 0 to 40°C
 - Humidity: 10% to 90% RH
- Output polarity:

NOTICE

This equipment has been tested and found to comply with the limits for a Class B digital device, pursuant to Part 15 of the FCC Rules. These limits are designed to provide reasonable protection against harmful interference in a residential installation. This equipment generates, uses and can radiate radio frequency energy and, if not installed and used in accordance with the instructions, may cause harmful interference to radio communications. However, there is no guarantee that interference will not occur in a particular installation. If this equipment does cause harmful interference to radio or television reception, which can be determined by turning the equipment off and on, the user is encouraged to try to correct the interference by one or more of the following measures:

- Reorient or relocate the receiving antenna.
- Increase the separation between the equipment and receiver.
- Connect the equipment into an outlet on a circuit different from that to which the receiver is connected.
- Consult the dealer or an experienced radio/TV technician for help.

FCC CAUTION

Changes or modifications not expressly approved by the party responsible for compliance could void the user's authority to operate the equipment.

Declaration of Conformity

Model Number: CDP-S90
 Trade Name: CASIO COMPUTER CO., LTD.
 Responsible party: CASIO AMERICA, INC.
 Address: 570 MT. PLEASANT AVENUE, DOVER, NEW JERSEY 07801
 Telephone number: 973-361-5400
 This device complies with Part 15 of the FCC Rules, Operation is subject to the following two conditions:
 (1) This device may not cause harmful interference, and (2) this device must accept any interference received, including interference that may cause undesired operation.

Important!

Please note the following important information before using this product.

- Before using the AD-A12150LW Adaptor to power the unit, be sure to check the AC Adaptor for any damage first. Carefully check the power cord for breakage, cuts, exposed wire and other serious damage. Never let children use an AC adaptor that is seriously damaged.
- The product is not intended for children under 3 years.
- Use only CASIO AD-A12150LW adaptor.
- The AC adaptor is not a toy.
- Be sure to disconnect the AC adaptor before cleaning the product.

Declaration of Conformity According to EU Directive

CE Manufacturer: CASIO COMPUTER CO., LTD. 6-2, Hon-machi 1-chome, Shibuya-ku, Tokyo 151-8543, Japan

Responsible within the European Union: Casio Europe GmbH Casio-Platz 1, 22848 Norderstedt, Germany www.casio-europe.com

Company and product names used in this manual may be registered trademarks of others.

About the AC adaptor that comes with the Digital Piano

Note the following important precautions to avoid damage to the AC adaptor and power cord.

- Never pull on the cord with excessive force.
- Never repeatedly pull on the cord.
- Never twist the cord at the base of the plug or connector.
- Before moving the Digital Piano, be sure to unplug the AC adaptor from the power outlet.
- Loop and bundle the power cord, but never wind it around the AC adaptor.

Any reproduction of the contents of this manual, either in part or its entirety, is prohibited. Except for your own, personal use, any other use of the contents of this manual without the consent of CASIO is prohibited under copyright laws. IN NO EVENT SHALL CASIO BE LIABLE FOR ANY DAMAGES WHATSOEVER (INCLUDING, WITHOUT LIMITATION, DAMAGES FOR LOSS OF PROFITS, BUSINESS INTERRUPTION, LOSS OF INFORMATION) ARISING OUT OF THE USE OF OR INABILITY TO USE THIS MANUAL OR PRODUCT, EVEN IF CASIO HAS BEEN ADVISED OF THE POSSIBILITY OF SUCH DAMAGES. The contents of this manual are subject to change without notice.