

# DATA PROJECTOR

## XJ-A130V/XJ-A135V\*

## XJ-A140V/XJ-A145V\*

## XJ-A150V/XJ-A155V\*

## XJ-A230V/XJ-A235V\*

## XJ-A240V/XJ-A245V\*

## XJ-A250V/XJ-A255V\*

- \* USB端子付きモデル
- \* USB port models
- \* Modelle mit USB-Port
- \* Modèles à port USB
- \* Modelos con puerto USB
- \* Modelli con porta USB
- \* Modeller med USB-port
- \* 配備USB端口的型號
- \* USB 포트 모델

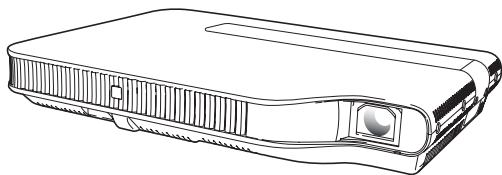

- 地域により販売されていないモデルもあります。
- Some models covered by this User's Guide may not be available in certain geographic areas.
- Einige der in diese Bedienungsanleitung einbezogenen Modelle sind in bestimmten Gebieten eventuell nicht erhältlich.
- Certains modèles couverts par ce mode d'emploi peuvent ne pas être commercialisés dans certaines zones géographiques.
- Algunos modelos cubiertos por esta Guía del usuario pueden no estar disponibles en determinadas áreas geográficas.
- Alcuni modelli riportati da questa Guida dell'utilizzatore potrebbero non essere disponibili in determinate aree geografiche.
- Vissa modeller som beskrivs i detta instruktionshäfte saluförs inte i vissa områden.
- 本ユーザー説明書で紹介の投影機中、有些型號可能未在某些地區銷售。
- 사용설명서의 일부 모델은 특정 지역에서는 이용할 수 없을 수도 있습니다.

### 取扱説明書（基本編）

本書はお読みになった後も大切に保管してください。

日本語

### User's Guide (Basic Operations)

Be sure to keep all user documentation handy for future reference.

English

### Bedienungsanleitung (Grundbedienung)

Bitte bewahren Sie die gesamte Benutzerdokumentation für späteres Nachschlagen auf.

Deutsch

### Mode d'emploi (Opérations de base)

Conservez la documentation à portée de main pour toute référence future.

Français

### Guía del usuario (Operaciones básicas)

Asegúrese de tener a mano toda la documentación del usuario para futuras consultas.

Español

### Guida dell'utilizzatore (Operazioni di base)

Conservare l'intera documentazione dell'utente a portata di mano per riferimenti futuri.

Italiano

### Instruktionshäfte (Grundläggande anvisningar)

Förvara all användardokumentation nära till hands för framtida referens.

Svenska

### 用戶說明書（基本操作）

請務必將所有用戶文件妥善保管以便日後需要時查閱。

中文（繁）

### 사용설명서 (기본 조작)

만약을 대비하여 사용설명서 등은 소중히 보관해 주십시오.

한국어

# User's Guide (Basic Operations)

English

English

- Be sure to read the “Safety Precautions” on page E-2 and “Operating Precautions” on page E-7 before trying to use this projector.
- This manual covers only basic operations, including how to set up the projector, how to connect a computer or video device to the projector, and basic projector operations. For more detailed information, see the User's Guide (UsersGuide\_English.pdf) on the CD-ROM that comes with the projector.

## Contents

<b>Safety Precautions</b> .....	<b>E-2</b>	<b>Projector Basics</b> .....	<b>E-21</b>
<b>Operating Precautions</b> .....	<b>E-7</b>	Selecting the Input Source .....	E-21
About the Light Source Unit .....	E-7	Adjusting the Projected Image .....	E-21
Other Precautions .....	E-7	Keystone Correction (KEYSTONE) .....	E-22
<b>Unpacking</b> .....	<b>E-9</b>	<b>Using the Setup Menu</b> .....	<b>E-23</b>
<b>Using the CD-ROM</b> .....	<b>E-9</b>	<b>User Maintenance</b> .....	<b>E-24</b>
Using the CD-ROM that comes with the XJ-A130V, XJ-A140V, XJ-A150V, XJ-A230V, XJ-A240V, XJ-A250V .....	E-9	Cleaning the Projector .....	E-24
Using the CD-ROM that comes with the XJ-A135V, XJ-A145V, XJ-A155V, XJ-A235V, XJ-A245V, XJ-A255V .....	E-10	About the Light Source Unit .....	E-24
<b>General Guide</b> .....	<b>E-11</b>	<b>Troubleshooting</b> .....	<b>E-24</b>
Preparing the Remote Controller .....	E-12	Indicators .....	E-24
<b>Getting Ready</b> .....	<b>E-14</b>	Projector Troubleshooting .....	E-25
Setting Up the Projector .....	E-14	<b>Specifications</b> .....	<b>E-28</b>
Setup Precautions .....	E-15		
Adjusting the Projector Elevation Angle .....	E-16		
Connecting a Computer to the Projector .....	E-17		
Connecting to a Standard Video Device .....	E-17		
Turning On the Projector .....	E-18		
Turning Off the Projector .....	E-20		

- DLP is a registered trademark of Texas Instruments Incorporated of the United States.
- Microsoft, Windows, Windows Vista, and PowerPoint are registered trademarks or trademarks of Microsoft Corporation in the United States and other countries.
- HDMI, the HDMI Logo and High-Definition Multimedia Interface are trademarks or registered trademarks of HDMI Licensing LLC.
- Apple and Macintosh are registered trademarks of Apple Inc. of the United States.
- Adobe and Reader are registered trademarks of Adobe Systems Incorporated.
- XGA is a registered trademark of IBM Corporation of the United States.
- ArcSoft and the ArcSoft logo are trademarks or registered trademarks of ArcSoft, Inc. in the United States and other countries.
- Other company and product names may be registered trademarks or trademarks of their respective owners.



- The contents of this User's Guide are subject to change without notice.
- Copying of this manual, either in part or its entirety, is forbidden. You are allowed to use this manual for your own personal use. Any other use is forbidden without the permission of CASIO COMPUTER CO., LTD.
- CASIO COMPUTER CO., LTD. shall not be held liable for any lost profits or claims from third parties arising out of the use of this product or this manual.
- CASIO COMPUTER CO., LTD. shall not be held liable for any loss or lost profits due to loss of data caused by malfunction or maintenance of this product, or any other reason.
- The sample screens shown in this manual are for illustrative purposes only, and may not be exactly the same as the screens actually produced by the product.

# Safety Precautions

Thank you for selecting this CASIO product. Be sure to read these “Safety Precautions” before trying to use it. After reading this User’s Guide, keep it in a safe place for future reference.

## About safety symbols

Various symbols are used in this User’s Guide and on the product itself to ensure safe use, and to protect you and others against the risk of injury and against material damage. The meaning of each of the symbols is explained below.

 <b>Danger</b>	This symbol indicates information that, if ignored or applied incorrectly, creates the risk of death or serious personal injury.
 <b>Warning</b>	This symbol indicates information that, if ignored or applied incorrectly, could possibly create the risk of death or serious personal injury.
 <b>Caution</b>	This symbol indicates information that, if ignored or applied incorrectly, could possibly create the risk of personal injury or material damage.

## Icon Examples



A triangle indicates a situation against which you need to exercise caution. The example shown here indicates you should take precaution against electric shock.



A circle with a line through it indicates information about an action that you should not perform. The specific action is indicated by the figure inside the circle. The example shown here means disassembly is prohibited.



A black circle indicates information about an action that you must perform. The specific action is indicated by the figure inside the circle. The example shown here indicates you must unplug the power cord from the power outlet.

## Precautions During Use

### **Warning**

#### ● **Smoke, odor, heat, and other abnormalities**



Should you ever notice smoke, strange odor, or any other abnormality, immediately stop using the projector. Continued use creates the risk of fire and electric shock. Immediately perform the following steps.

1. Unplug the projector.
2. Contact your original dealer or authorized CASIO service center.

#### ● **Malfunction**



Immediately stop using the projector if the screen appears abnormal, or if any other abnormal operation occurs even though you are operating the projector correctly. Continued use creates the risk of fire and electric shock. Immediately perform the following steps.

1. Turn off the projector.
2. Unplug the projector.
3. Contact your original dealer or authorized CASIO service center.

#### ● **Power cord**



Misuse of the power cord creates the risk of fire and electric shock. Make sure that you always observe the following precautions.

- Make sure that you use a power source with the same voltage as that specified for the projector.
- Do not overload a power outlet with too many devices.



A damaged power cord creates the risk of fire and electric shock. Make sure that you always observe the following precautions.

- Never place heavy objects on the power cord and never expose it to heat.
- Make sure the power cord is not pinched between the wall and the rack or table where the projector is located, and never cover the power cord with a cushion or other object.
- Never try to modify the power cord, allow it to become damaged, or subject it to excessive bending.
- Do not twist the power cord or pull on it.



Never touch the power cord or plug while your hands are wet. Doing so creates the risk of electric shock.

- When using this projector in the country where you purchased it, be sure to use the power cord that came with it. Whenever using the projector in another country, be sure to purchase and use a power cord that is rated for the voltage of that country. Also make sure that you are aware of the Safety Standards that apply in that country.

**● Water and foreign matter**



Never allow water to get on the projector. Water creates the risk of fire and electric shock.



Never place a vase or any other container of water on top of the projector. Water creates the risk of fire and electric shock.



Water or other liquid, or foreign matter (metal, etc.) getting into the projector creates the risk of fire and electric shock. Should anything get inside the projector, immediately perform the following steps.

1. Turn off the projector.
2. Unplug the projector.
3. Contact your original dealer or authorized CASIO service center.

**● Disassembly and modification**



Never try to take the projector apart or modify it in any way. The projector contains a large number of high-voltage components that create the risk of electric shock and burn injury. Also, note that problems caused by unauthorized projector disassembly or modification are not covered by the warranty and are not eligible for repair by CASIO.

Be sure to leave all internal inspection, adjustment, and repair up to your original dealer or authorized CASIO service center.

**● Dropping and impact**



Continued use of the projector after it has been damaged by dropping or other mistreatment creates the risk of fire and electric shock. Immediately perform the following steps.

1. Turn off the projector.
2. Unplug the projector.
3. Contact your original dealer or authorized CASIO service center.

**● Disposal by burning**



Never try to dispose of the projector by burning it. Doing so can cause an explosion, which creates the risk of fire and personal injury.

**● Looking into the lens or vents while light source unit is on**



Never look directly into the lens or vents while light source unit is on. The strong light emitted by the projector creates the risk of eye damage.

**● Blocking the vents**



Never allow the intake vents or the exhaust vents to become blocked. Doing so causes internal heat build up, which creates the risk of fire and breakdown of the projector. Touching the projector while it is hot creates the risk of burn injury. Make sure that you always observe the following precautions.

- Allow at least 30cm (11.8 inches) between the projector and walls.
- Do not insert the projector into any space where air circulation is poor.
- Never cover the projector with a blanket or any similar item.
- Locate the projector on a firm, flat surface during use. Never use the projector while it is on a carpet, blanket, towel, seat cushion, or other pliable surface.
- Never stand the projector up on either end during use.

## Safety Precautions

---

### ● Projector cabinet



Never open the projector's cabinet. Doing so creates the risk of electric shock.

### ● Cleaning



Before cleaning the projector, be sure to turn it off and unplug it from the power outlet. Failure to do so creates the risk of electric shock.

### ● Exhaust vents

The exhaust vents become very hot while the projector is running. Never touch them. Doing so creates the risk of burn injury. The areas near the exhaust vents also become quite hot. Never locate objects made of plastic or other heat-sensitive materials near or under the projector. Doing so creates the risk of deformation and discoloration of the object.

### ● Lens cover

Be sure to remove the lens cover before turning on the projector. Never leave the lens cover attached while the projector is in use.

### ● Location

Never locate the projector in any of the following types of locations. Doing so creates the risk of fire and electric shock.

- Near an area subject to strong vibration
- An area subject to large amounts of moisture or dust
- In a kitchen or other area exposed to oil smoke
- Near a heater, on a heated carpet, or in an area exposed to direct sunlight
- An area subject to temperature extremes (Operating temperature range is 5°C to 35°C (41°F to 95°F)).

### ● Heavy objects

Never place heavy objects on the projector or climb on top of the projector. Doing so creates the risk of fire and electric shock.

### ● Water

Never locate the projector in a bathroom or anywhere else there is the chance that it will be splashed with water.

### ● Unstable location



Never place the projector on an unstable surface or on a high shelf. Doing so can cause it to fall, creating the risk of personal injury.

### ● Using the projector on a base with casters

Whenever using the projector on a base that has casters, make sure that you lock the casters when not moving the base.

### ● Lightening

During a lightning storm, do not touch the plug of the projector's power cord.

### ● Remote controller



Never try to take the remote controller apart or modify it in any way. Doing so creates the risk of electric shock, burn injury, and other personal injury. Be sure to leave all internal inspection, adjustment, and repair up to your original dealer or authorized CASIO service center.



Never allow the remote controller to become wet. Water creates the risk of fire and electric shock.

### ● Radio waves emitted by the wireless adapter (which is provided with or built into some projector models)



Never use this product inside of an aircraft or medical facility, or in any other location where use of such devices is prohibited. Radio waves can have an effect on the operation of electronic equipment and medical equipment, and cause accidents.



Do not use this product in the vicinity of high-precision electronic instruments or electronic devices that handle weak radio signals. Radio waves can have an effect on the operation of such equipment, and cause accidents.

- If you are using a pace maker or any other electronic medical device, be sure to consult your physician or device manufacturer before using this product.

**⚠ Caution**

● **Power cord**



Misuse of the power cord creates the risk of fire and electric shock. Make sure that you always observe the following precautions.

- Do not locate the power cord near a stove.
- When unplugging the power cord, always grasp the plug, and do not pull on the power cord.
- Insert the plug into the power outlet as far as it will go.
- After using the projector, unplug it from the power outlet.
- Unplug the projector from the power outlet if you do not plan to use it for a long time.
- At least once a year, unplug the power plug and use a dry cloth or vacuum cleaner to clear dust from the area around the prongs of the power plug.
- Never use detergent to clean the power cord, especially the power plug and jack.
- Before moving the projector, be sure to turn it off and unplug it from the power outlet first.

● **Backup of important data**



Be sure to keep separate written records of all data stored in projector memory. Memory data can be lost due to breakdown, maintenance, etc.

● **Lens effect**

Never have an aquarium or any other object that produces a lens effect in front of the projector while the light source unit is on. Such an object creates the risk of fire.

● **Lens**

Never touch the lens with your hand.

● **Wireless adapter (provided with or built into some projector models)**



Keep the wireless adapter out of the reach of small children. Accidental swallowing of a wireless adapter can interfere with proper breathing and create a life-threatening situation.

**Battery Precautions**

**⚠ Warning**

Misuse of batteries can cause them to leak and stain the area around them, or to explode, creating the risk of fire and personal injury. Make sure that you always observe the following precautions.



- Never try to take batteries apart and do not allow them to become shorted.
- Never expose batteries to heat or throw them into fire.
- Never mix old batteries and new ones.
- Never mix batteries of different types.
- Never try to charge batteries.
- Take care that batteries are oriented correctly when you load them.



**⚠ Caution**

Misuse of batteries can cause them to leak and stain the area around them, or to explode, creating the risk of fire and personal injury. Make sure that you always observe the following precaution.



- Use only the type of batteries that is specified for the remote controller.

● **Dead batteries**

Be sure to remove batteries from the remote controller as soon as they go dead.



- Remove batteries from the remote controller if you do not plan to use it for a long time.

● **Disposing of batteries**

Make sure that you dispose of used batteries in accordance with the rules and regulations in your local area.

## Safety Precautions

---

### Lens Cover

#### Warning



The lens cover of this Data Projector uses a magnetic attachment. Because of this, it should not be used in the vicinity of anyone wearing a pacemaker or any other electric medical device. Should any problem arise, move the lens cover away from the person experiencing the problem and consult a physician.

#### Caution



Keep the lens cover away from floppy disks, magnetic cards, magnetic tapes, prepaid cards, checks, and any other media that uses magnetic recording. The lens cover can corrupt data recorded on magnetic media.

### Other

#### Caution

Allowing dust to build up inside the projector for long periods without cleaning creates the risk of fire and breakdown. Contact your original dealer or authorized CASIO service center once a year about having the interior of the projector cleaned. Note that you will be charged for cleaning.

# Operating Precautions

## About the Light Source Unit

- The projector's light source unit uses a laser and LED.
- The life of the light source unit is rated at approximately 20,000 hours. The actual life will depend on use conditions, the settings configured on the setup menu, and differences between each individual light source unit.
- The light source unit is warranted for the period noted on the warranty certificate or for 6,000 hours, whichever comes first.
- The failure of the light source unit to light or a noticeable drop in light source unit brightness indicates the end of the light source unit's life. Contact your original dealer or authorized CASIO service center for replacement.

## Other Precautions

This projector is made of precision components. Failure to observe the following precautions can result in inability to correctly save data and malfunction.

### ● Never use or store the projector in the following locations. Doing so creates the risk of malfunction of and damage to the projector.

- Locations subjected to electrostatic charge
- Locations subjected to temperature extremes
- Locations where there is extreme moisture
- Locations subjected to sudden temperature changes
- Locations where there is a lot of dust
- On a shaky, slanted, or otherwise unstable surface
- Locations where there is the danger of getting wet

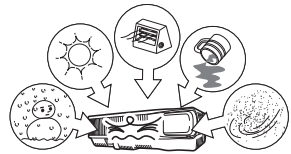

### ● Avoid using the projector under the following conditions. Such conditions create the risk of malfunction of and damage to the projector.

- Avoid areas subject to temperature extremes (operating temperature range is 5°C to 35°C (41°F to 95°F)).
- Never place heavy objects on the projector or climb on top of the projector.
- Never insert or allow foreign objects to drop into the projector.
- Never place a vase or any other container of water on top of the projector.



### ● Never leave a dead battery inside the remote controller for a long time.

A dead battery can leak, which leads to malfunction of and damage to the remote controller.

### ● Clean with a soft, dry cloth.

When very dirty, use a soft cloth that has been dampened in a weak solution of water and a mild neutral detergent. Wring all excess water from the cloth before wiping. Never use thinner, benzine, or any other volatile agent to clean the projector. Doing so can remove its markings and cause staining of the case.

### ● Missing Screen Dots

Though this projector is manufactured using the most advanced digital technology available today, some of the dots on the screen may be missing. This is normal, and does not indicate malfunction.



## Operating Precautions

---

### ● Never subject the projector to strong impact while it is projecting.

If the projector is accidentally subjected to strong impact, the projection image will momentarily go blank. The image will reappear after some time, but it may be the wrong color or it may be accompanied by an error message.

If the projected image is the wrong color, re-select the current input source. If this does not return the projected image to its proper color, use the procedure under "To turn off the projector" on page E-20 to turn projector power off and then back on again.

If the image reappears with an error message, correct the problem in accordance with the indicator explanations under "Error Indicators and Warning Messages" in the User's Guide on the CD-ROM that comes with the projector.

### ● Keystone Correction and Image Quality

Performing keystone correction causes the image to be compressed before it is projected. This can result distortion of the image or a loss of image quality. If this happens, change orientation of the projector and/or screen so it conforms as much as possible to the illustration under "Setting Up the Projector" on page E-14.

If image quality is the highest priority, turn off auto keystone correction and position the projector so it is pointed straight at the screen.

- Even if your projector is still within the warranty period, you will be charged for repair if a problem is due to running the projector non-stop for very long periods (like 24 hours) or if the projector was set up and used without following the "Setup Precautions" on page E-15 of this manual.

### ● Precaution when Handling the Projector after Use

The projector's exhaust vents and the area around the vents become very hot during operation, and will still be hot immediately after turning off the projector. Because of this, you should hold the sides of the projector as shown in the illustration whenever moving it.

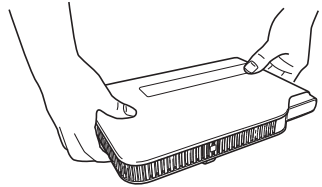

### ● Stowing the Projector in the Carrying Bag

Make sure the projector is no longer warm before stowing it in the carrying bag.

# Unpacking

As you unpack the projector, check to make sure that all of the items listed below are present.

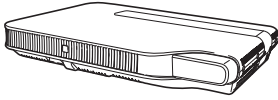

DATA PROJECTOR



Remote Controller  
(YT-100)

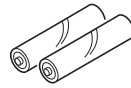

Test Batteries  
(AAA-size x 2)



AC Power Cord



Special AV Cable



Mini D-Sub Cable

- Carrying Bag
- CD-ROM
- User's Guide (Basic Operations)
- "Read this first" Sheet
- Warranty
- Wireless adapter (Provided with or built into models equipped with USB ports only.)

## Using the CD-ROM

What you need to do to use the CD-ROM that comes with the projector depends on your projector model.

### Using the CD-ROM that comes with the XJ-A130V, XJ-A140V, XJ-A150V, XJ-A230V, XJ-A240V, XJ-A250V

The CD-ROM that comes with the projector has a PDF file "User's Guide" that contains detailed explanations about projector operations. In order to read the User's Guide, you need to have Adobe® Reader® installed on your computer.

#### To read the User's Guide contents

1. Place the bundled CD-ROM into your computer's CD-ROM drive.
2. Navigate to the CD-ROM, and open the "User's Guide" folder.
3. Double-click "UsersGuide\_English.pdf".
  - This starts up Adobe Reader and displays the contents of the manual whose icon you clicked.
  - On some systems, the ".pdf" extension may not appear at the end of the file name.

## Using the CD-ROM

### Using the CD-ROM that comes with the XJ-A135V, XJ-A145V, XJ-A155V, XJ-A235V, XJ-A245V, XJ-A255V

The CD-ROM contains software for each projector model and PDF files with User's Guides. In order to read the User's Guide, you need to have Adobe® Reader® installed on your computer.

#### To view the contents of a User's Guide (PDF)

1. Place the CD-ROM that comes with the projector into your computer's CD-ROM drive.
  - This will automatically display the CD-ROM menu screen.
2. On the menu screen, click the [Open Folder] button to the right of the "User's Guide".
  - This will open the "User's Guide" folder.
3. In the "User's Guide" folder, open the "English" folder.
4. Double-click the name of the manual you want to view.
  - The table below describes the contents of the manuals.

Manual Name	Description	File Name
User's Guide	Contains detailed information about the projector.	UsersGuide_English.pdf
USB Function Guide	Explains operations when connecting USB memory, a CASIO Multi Projection Camera (YC-400, YC-430), or a graphic scientific calculator to the USB port on the back of the projector.	USB_Guide_English.pdf
Wireless Function Guide	Explains operations when establishing a wireless LAN connection between the projector and a computer and projecting the computer's display contents.	WirelessGuide_English.pdf

- Double-clicking a file name starts up Adobe Reader and displays the contents of the applicable manual.
- On some systems, the ".pdf" extension may not be displayed at the end of the file name.

#### Installing the Software

The software described in the table below can be installed from the CD-ROM menu screen that appears when you place the CD-ROM that comes with the projector into your computer's CD-ROM drive. For details about installing the software, see the manuals in the "Refer to:" column of the table.

Software Name	Description	Refer to:
Wireless Connection 3	Software that makes it possible to establish a wireless connection between a projector and computer.	Wireless Function Guide (WirelessGuide_English.pdf)
EZ-Converter FA	Software that converts PowerPoint files to ECA files.	USB Function Guide (USB_Guide_English.pdf)
ArcSoft MediaConverter 3 for CASIO Projector	Software for converting movie files.	
Multi Projection Camera Update Software	Software for updating the firmware of the YC-400 Multi Projection Camera.	

#### Important!

- The latest version of the computer software included on the CD-ROM that comes with this product is available for download at the CASIO website URL below:  
<http://www.casio.com/support/driverdownloads/>

Be sure to download and use the latest version of the software.

[ Home - Support - Drivers/Downloads - Projectors ]

# General Guide

## [Front/Top/Left Side]

**CLASS 1 LASER PRODUCT**

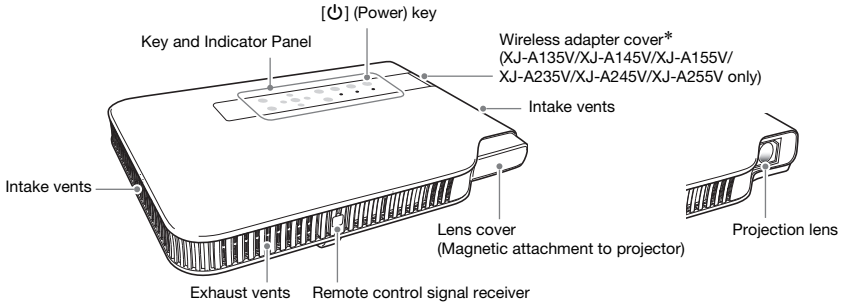

## [Bottom]

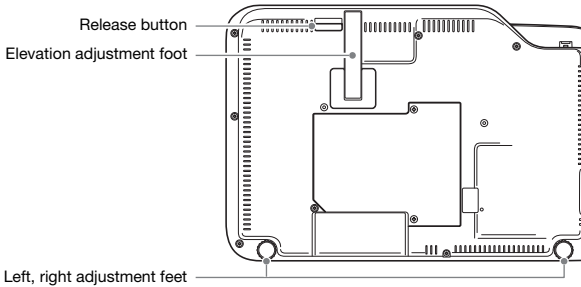

# General Guide

## [Back, Terminals]

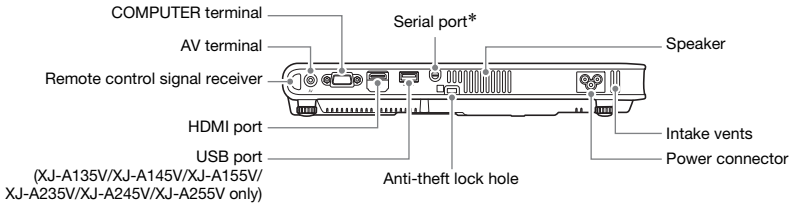

\* This serial port is for connecting a separately available special cable (YK-5) to control the projector from a computer.

### NOTE

- The anti-theft lock hole is provided for connection of an anti-theft chain. Visit the Kensington Lock Website at <http://www.kensington.com/> for more information.

## Preparing the Remote Controller

The remote controller does not come with batteries loaded. You need to load the two supplied batteries before use.

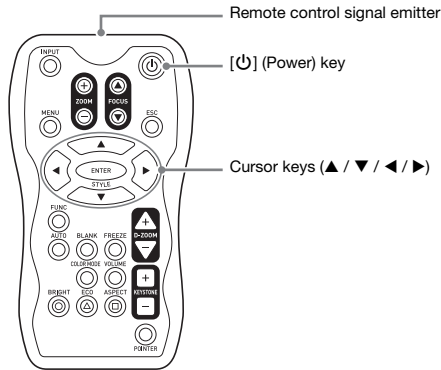

## Loading Remote Controller Batteries

### Important!

- Be sure to use alkaline batteries only.

 <b>Caution</b>	RISK OF EXPLOSION IF BATTERY IS REPLACED BY AN INCORRECT TYPE. DISPOSE OF USED BATTERIES ACCORDING TO THE INSTRUCTIONS.
--	---

 <b>Caution</b>	<p>Misuse of batteries can cause them to leak and stain of the area around them, or to explode, creating the risk of fire and personal injury. Make sure that you always observe the following precautions.</p> <ul style="list-style-type: none"> <li>● Take care that batteries are oriented correctly when you load them.</li> <li>● Never mix old batteries and new ones.</li> <li>● Never mix batteries of different types.</li> <li>● Use only battery type that is specified for use with the remote controller.</li> </ul>
--	--

1. Open the battery cover on the back of the remote controller.
2. Load two new batteries into the case, making sure that their positive (+) and negative (-) ends are facing correctly.

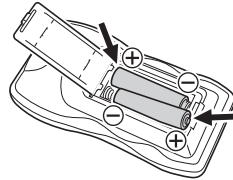
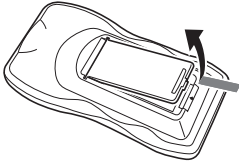

3. Close the battery cover on the back of the remote controller.

### Replacing Remote Controller Batteries

Open the battery cover on the back of the remote controller, replace the old batteries with new ones, and then close the battery cover.

### Important!

- To avoid running down the batteries, store the remote control unit so its buttons are not pressed inadvertently.

# Getting Ready

## Setting Up the Projector

Locate the projector on a desk, table, or stand that is firm and level. Make sure to allow sufficient space around the sides and back of the projector for proper ventilation.

- The following illustrations show how the projector should be oriented for optimum projection relative to the screen.

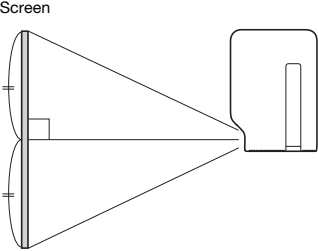
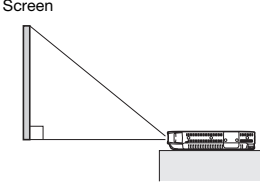
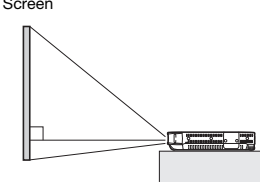
Viewed from Above	Viewed from the Side (XJ-A130V/XJ-A135V/XJ-A140V/ XJ-A145V/XJ-A150V/XJ-A155V)
 <p data-bbox="154 432 204 448">Screen</p> <p data-bbox="120 703 460 735">The center of the projector's lens should be aligned with the horizontal center of the screen.</p>	 <p data-bbox="743 389 796 405">Screen</p> <p data-bbox="553 485 736 539">Make sure the projector is at a right angle to the screen.</p>
	<b>Viewed from the Side (XJ-A230V/XJ-A235V/XJ-A240V/ XJ-A245V/XJ-A250V/XJ-A255V)</b>
	 <p data-bbox="743 683 796 699">Screen</p> <p data-bbox="553 778 736 833">Position the projector so the lens side is at the edge of the table, etc.</p>

### Important!

- The projector can be oriented at an angle so its lens is pointing up to 30 degrees upwards (+30°) or 30 degrees downwards (-30°).  
Note that orienting the projector at a greater angle will shorten light source unit life and cause malfunction.  
There is no limit on how much the projector can be angled horizontally (left and right).
- The projector's auto keystone correction range is 0 to +30 degrees. If the surface you are projecting onto is angled downwards from horizontal, use manual keystone correction (page E-22) to correct the image.
- Turn on the "Option Settings 2 → High Altitude" setting on the setup menu when using the projector in a high altitude (1,500 to 3,000 meters (5,000 to 10,000 feet) above sea level) area where air is thin. For details, see the User's Guide on the CD-ROM that comes with the projector.

### NOTE

- The projector can be configured for projection from the back of a screen. For details, see the User's Guide on the CD-ROM that comes with the projector.

## Setup Precautions

Note that operating conditions greatly affects the performance of the projector. Make sure you only operate the projector in the type of environment described below.

- Use a conveniently located power outlet that you can reach easily when you need to unplug the projector.
- Do not place any objects within the area indicated by the dashed line in the illustration below. Keep all items at least 30cm (11.8 inches) away from the intake and exhaust vents.

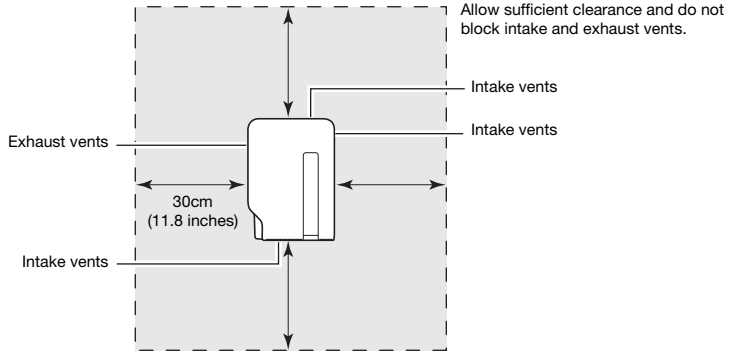

- The vents become quite hot while the projector is in use. Never touch the vents with your hands. Also, the areas near the exhaust vents become quite hot. Never locate objects made of plastic or other heat-sensitive materials near or under the projector. Doing so creates the risk of deformation and discoloration of the object.
- Avoid placing the projector on a surface that is unstable or prone to vibration. Never place the projector on top of a carpet, blanket, towel, or other soft material.
- Do not locate the projector where it will be exposed to direct sunlight.
- Avoid locations where there are large amounts of dust and moisture.
- Keep the projector away from speakers, TVs, radios, and other devices that generate magnetism, as well as from heaters.
- Over time, use of the projector can cause dust and dirt to build up in and around the fan's intake vents, which can lead to malfunction of the projector. Be sure to check the intake vents for dust build up each time before you use the projector. If you see dirt or dust in or around the intake vents, remove it by wiping with a cloth, etc.
- When positioning the projector, make sure you do so in such a way that the intake vents do not become blocked. Blocked intake vents can shorten the life of the light source unit.
- Airflow from air conditioning equipment can blow the heat being exhausted from the area around the projector's lens in a way that causes heat ripples to appear in the projected image. If this happens, adjust the airflow of the air conditioning equipment or move the projector.



### Adjusting the Projector Elevation Angle

You can change the elevation angle of the projector in a range of 0 to 20 degrees. You can also make fine adjustments to the left and right side elevation angle when necessary.

#### To change the projector elevation angle

1. Lift up the front of the projector and press the release button ①.
  - This causes the elevation adjustment foot ② to drop from the bottom of the projector.
  - Be sure to press the release button before trying to lower the elevation adjustment foot. Pulling on the foot without pressing the release button can damage the foot.
2. While holding down the release button, raise and lower the front of the projector until the elevation adjustment foot is approximately the length you need.
3. Release the release button to lock the elevation adjustment foot in its current position.
4. Use the left and right adjustment feet ③ to further fine adjust the elevation angle.
  - The left and right adjustment feet are for fine adjustment only. Do not try to rotate them too far. Doing so can cause an adjustment foot to detach. Tightening an adjustment foot too strongly can cause it to become stuck.

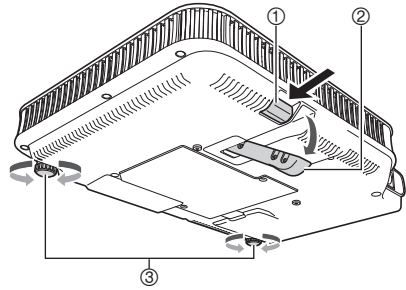

#### Important!

- To retract the elevation adjustment foot, hold down the release button and slide the elevation adjustment foot back into the projector. Never try to forcibly change the elevation adjustment foot position without pressing the release button.

## Connecting a Computer to the Projector

You can use the projector to project an image of analog RGB output from a computer.

### Important!

- Always turn off the projector and the computer before connecting them.
- Take care so the volume level of the computer is not set too high.

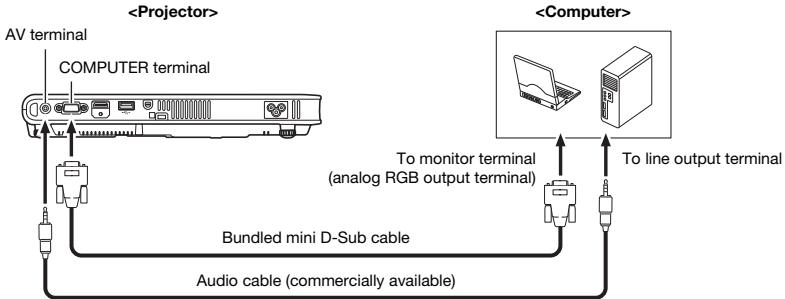

## Connecting to a Standard Video Device

You can use the projector to project an image from a video deck, TV, video camera, or other video device.

### Important!

- Always turn off the projector and the video device before connecting them.

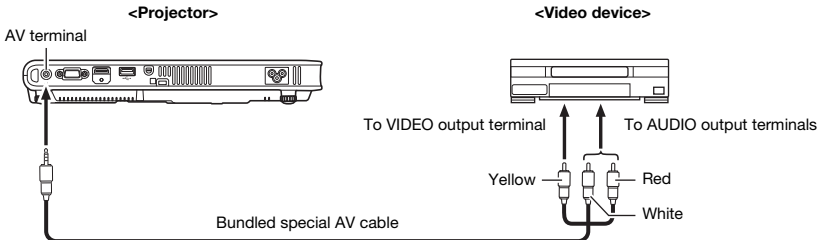

- You can use the bundled special AV cable to connect to a pin jack (RCA) type VIDEO output terminal. When connecting a video camera or other video device with a special video output terminal, use the special cable that comes with the video device. For details, see the documentation that comes with the video device.

### NOTE

For details about the following types of connections, see the User's Guide on the CD-ROM that comes with the projector.

- Projector and component video output of video device
- Projector and HDMI output of video device or computer

### Turning On the Projector

Before performing any of the operations in this section, make sure you first set up the projector and connect to an output device.

#### AC Power Cord Precautions

- Use the AC power cord that comes with the projector.
- Make sure that you use a power source with the same voltage as that specified for the projector.
- Do not share the outlet supplying power to the projector with other devices. If you are using an extension cord, make sure that the ampere rating of the extension cord is compatible with the power consumption value of this projector.
- Never use the power cord while it is still bundled together.
- Never place objects on top of the power cord and do not step on it.
- Never pull on the power cord. When unplugging it, grasp the plug.
- Use a conveniently located power outlet that you can reach easily when you need to unplug the projector.
- If you need more information about the power supply, contact your original dealer or authorized CASIO service center.

#### To turn on the projector

1. Use the bundled AC power cord to plug the projector into a power outlet.

- Plugging into a power outlet causes the three indicators on the top of the projector to light amber. After a short while, two of the indicators will go out and only the POWER/STANDBY indicator will remain lit amber, which indicates the standby state.
- Note that the projector will not turn on if you press the [⏻] (Power) key while all three indicators are lit amber. Wait until the projector is in the standby state before trying to turn it on.

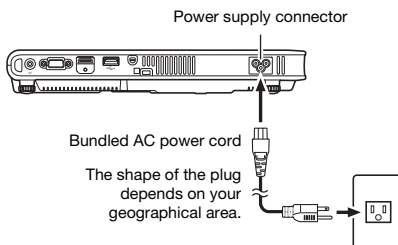

#### NOTE

- This product is also designed for IT power distribution system with phase-to-phase voltage 230V.

2. Turn on the computer or video device that is connected to the projector.

3. If the projector lens cover is covering the lens, remove it.

4. Press the [⏻] (Power) key.

- This causes the POWER/STANDBY indicator to flash green.
- Within a few seconds, POWER/STANDBY indicator stops flashing and remains lit green, and the projector starts projecting an image from the device connected to it.
- A “Language” window will be projected the first time you turn on the projector. Use the procedure under “Specifying the Display Message Language” on the page E-19 to configure the language settings.

#### NOTE

- If the Eco Mode is turned on, the LIGHT indicator will light green when the projector is turned on.

## Specifying the Display Message Language

A “Language” window will be projected the first time you turn on the projector. Use the menu on this screen to specify the display language you want to use.

1. Use the cursor [▲] and [▼] keys to highlight the language you want to use.



2. Press the [ENTER] key.

### Turning Off the Projector

#### Caution

- The projector may remain quite hot for a while after you turn it off. Take care when moving the projector or otherwise handling it after use. See “Precaution when Handling the Projector after Use” (page E-8) for more information.
- Make sure that the projector is cooled down sufficiently before storing it.

#### To turn off the projector

1. Press the [⏻] (Power) key.
  - This causes the confirmation message “Do you want to turn off the projector?” to appear in the center of the projection screen.
  - If you do not turn off the projector the confirmation message will disappear automatically after about 10 seconds. The confirmation message will also disappear if you press the [ESC] key.
2. To turn off the projector, press the [⏻] (Power) key again in response to the confirmation message.
  - This causes the projector light source unit to go out and stops projection.
3. After checking to make sure that the POWER/STANDBY indicator has stopped flashing amber and remains lit, unplug the AC power cord from the power outlet.
  - This causes the POWER/STANDBY indicator to go out.
4. After ensuring that the projector and the connected computer or video device are turned off, disconnect the connecting cables from the projector and the connected device.
5. Close the lens cover.

#### NOTE

- You can turn off the projector by simply unplugging the power cord without pressing the [⏻] (Power) key (Direct Power Off). Note, however, that doing so while Zoom Memory (Option Settings 2 → Zoom Memory) is enabled will not save the current projection size setting. For more information, see the User’s Guide on the CD-ROM that comes with the projector.
- The projector turns off automatically after a certain amount of time of key operation and input signal inactivity (Auto Power Off). The Auto Power Off trigger time can be specified on the setup menu. The initial default setting is 10 minutes.

## Selecting the Input Source

Turning on the projector initially causes the same input source that was selected the last time it was turned off to be selected. You can perform the following steps to select a different input source.

1. Press the [INPUT] key.
  - This displays the input source selection screen.
2. Use the [▲] and [▼] keys to select the name of the input source you want to select and then press the [ENTER] key.
  - The name of the input source you select appears in the upper right corner of the projection screen for a few seconds.
  - The message “No signal input.” will appear if no input signal can be selected.

### Important!

#### ● Resolution

Depending on the projector model, its video resolution will be fixed at XGA (1024 × 768 pixels) or WXGA (1280 × 800 pixels). Images may appear coarse, text and other figures may be difficult to read or a moire pattern may appear when the input signal from a computer does not match the projector's video resolution. If this happens, try doing the following.

- Change the computer's output resolution setting so it matches the projector's video resolution.

For information about the video resolution of your projector, see the “DLP chip” item of the “Specifications” (page E-28). See the user documentation that comes with your computer for details about changing its settings.

- Change the “Aspect Ratio” setting to “True” (Applies only to models that support WXGA video resolution).

With the “True” setting, the projector projects the input signal at its actual size (1 input source dot equal to one projector output pixel dot).

For information about configuring the Aspect Ratio setting, see “Changing the aspect ratio of the projected image” in the User's Guide on the CD-ROM that comes with the projector.

## Adjusting the Projected Image

### To adjust the size of the projected image

Hold down the [ZOOM +] key to increase the size of the image or the [ZOOM -] key to decrease it. When the image is the size you want, release the key.

#### Projector key operation

Press the [ZOOM] key and then hold down the [➤] or [↗] key to increase the size of the image, press the [ZOOM] key and then hold down the [⏪] or [↘] key to decrease it. When the image is the size you want, release the key.

### To adjust image focus

Hold down the [FOCUS ▲] or [FOCUS ▼] key. When the focus is the way you want, release the key.

#### Projector key operation

Press the [FOCUS] key and then hold down the [⏪] ([↘]) or [➤] ([↗]) key to focus. When focus is the way you want, release the key.

## Projector Basics

---

### Auto Adjustment of an RGB Image

The projector automatically adjusts vertical and horizontal positioning, frequency, and phase whenever it starts projecting an RGB signal (following input source selection, power up, etc.). You can also execute an automatic adjustment operation by pressing the [AUTO] key when the input source is RGB.

#### NOTE

- When you want to disable auto adjustment and maintain manual settings, you can turn off auto adjustment by selecting “Off” for the “Option Settings 1 → Auto Adjust” setting on the setup menu.
- The projected image may become distorted while an auto adjustment operation is in progress.
- If an image is unclear following the auto adjustment operation, you can use the menu to adjust items manually.

### Keystone Correction (KEYSTONE)

When the projector is at an angle to the screen it is projecting on, the projected image may have different length top and bottom edges. This phenomenon is called, “keystoning”. This projector comes with functions for automatic as well as manual keystone correction, which provides a regularly shaped projected image.

#### **Important!**

- **Keystone correction can cause the corrected image to be smaller than the original (uncorrected) image, or it can cause distortion of the image. If the projected image becomes difficult to view, try moving the screen and/or projector so they are oriented close to the configuration shown under “Setting Up the Projector” on page E-14.**
- **The projector does not support horizontal keystone correction. The center of the projector’s lens should be aligned with the horizontal center of the screen (page E-14).**

### Automatic Keystone Correction

When “On” is selected for the “Option Settings 1 → Auto Keystone Correction” setting on the setup menu, the projector will detect the vertical orientation of the object in the image and adjust its shape automatically so it appears as a rectangle. The message “Auto Keystone Corrected.” appears in the center of the projected image when the projector performs auto keystone correction.

- The projector’s auto keystone correction range is 0 to +30 degrees. If the surface you are projecting onto is angled downwards from horizontal, use manual keystone correction to correct the image.

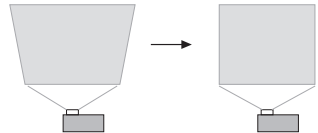

#### NOTE

- Auto keystone correction is performed by detecting the elevation angle of the projector. This means that the surface you are projecting onto needs to be standing straight up. If the surface you are projecting onto is not straight, use manual keystone correction to correct the image.

### To use manual keystone correction

1. Press the [KEYSTONE +] or [KEYSTONE -] key.
  - This causes the keystone correction screen to appear on the projected image.
2. Use the [KEYSTONE +] and [KEYSTONE -] keys to correct for keystoning.
  - Correction can be performed for keystoning within  $\pm 30^\circ$ .
3. To close the setup screen, press the [ESC] key.

# Using the Setup Menu

Pressing the [MENU] key while an image is being projected displays the setup menu on the projected image. The setup menu can be used to configure a variety of different projector settings. Use the cursor keys [▲]/[▼]/[◀]/[▶] and [ENTER] key to select and configure settings.

- For detailed information about settings and how they are configured, see the User's Guide (UsersGuide\_English.pdf) on the CD-ROM that comes with the projector.
- If your projector is equipped with a USB port, see the user documentation on the CD-ROM that comes with it for information about the "USB" main menu item (USB Function Guide) and the "Wireless" main menu item (Wireless Function Guide).

## Setup Menu List

Main menu	Sub-menu
<b>Image Adjustment 1</b>	Brightness
	Contrast
	Sharpness
	Saturation
	Tint
	Color Mode
	Color Balance
	Eco Off Mode
	Restore Menu Defaults
<b>Image Adjustment 2</b>	Vertical Position
	Horizontal Position
	Frequency
	Phase
	Restore Menu Defaults
<b>Volume Adjustment</b>	Volume
	Restore Menu Defaults
<b>Screen Settings</b>	Keystone Correction
	Aspect Ratio
	Projection Mode
	Ceiling Mount
	Startup Screen
	No Signal Screen
	Blank Screen
	Restore Menu Defaults
<b>Input Settings</b>	COMPUTER Terminal
	Video Signal
	Signal Name Indicator
	Restore Menu Defaults

Main menu	Sub-menu
<b>Option Settings 1</b>	Auto Keystone Correction
	Auto Adjust
	Eco Mode
	Auto Power Off
	Power On Password
	Direct Power On
	Language
	Restore Menu Defaults
	<b>Option Settings 2</b>
Pointer	
Plug and Play (USB port models only)	
USB Audio Out (USB port models only)	
HDMI Audio Out	
High Altitude	
Restore Menu Defaults	
<b>USB (USB port models only)</b>	
<b>Wireless (USB port models only)</b>	
<b>Operational Info</b>	Input Signal
	Signal Name
	Resolution
	Horizontal Frequency
	Vertical Frequency
	Scan System
	Light Time
<b>Restore All Defaults</b>	Unit Operating Time
	Restore All Defaults



# User Maintenance

## Cleaning the Projector

Periodically clean the projector exterior, lens, intake vents, and exhaust vents on a regular basis.

### Cleaning Intake and Exhaust Vents

Dust and dirt tend to collect around the intake vents. Because of this, you should use a vacuum cleaner to clean away accumulated dust and dirt periodically.

#### Important!

- **Continued use of the projector after dust has accumulated around the intake vents can cause overheating of internal components and lead to malfunction.**
- **Certain operating conditions also can cause dirt and dust to accumulate around the projector's exhaust vents on the front. If this happens, use the same procedure as that described above to clean the exhaust vents.**

## About the Light Source Unit

Should the light source unit stop working, contact your original dealer or authorized CASIO service center for replacement. Note that problems caused by unauthorized projector disassembly or modification are not covered by the warranty and are not eligible for repair by CASIO.

# Troubleshooting

## Indicators

Indicators keep you informed about the current operational status of the projector. The following shows what the indicators look like when operation is normal.

When this indicator:	Is this:	It means this:
POWER :	Amber steady	You have just plugged the AC power cord into a power outlet. Wait until the projector enters the standby state (see below) before trying to turn on power.
TEMP :	Amber steady	
LIGHT :	Amber steady	
POWER :	Amber steady	Standby state: The AC power cord is plugged in and the projector is in standby.
POWER :	Green flashing	Projector is warming up after being turned on.
POWER :	Green steady	Projector is on and standing by for use.
POWER :	Amber flashing	Projector is performing internal power down processes.
LIGHT :	Green steady	The projector's Eco Mode is turned on.

- When a warning message appears on the projection screen, or when the POWER, TEMP, and LIGHT indicators are lit or flashing in a pattern other than those shown above, it means that a projector error has occurred. For details about indicators and warning messages, see the User's Guide on the CD-ROM that comes with the projector.

## Projector Troubleshooting

Check the following items whenever you experience any problem with the projector.

Problem	Cause and Recommended Action	See
The projector does not turn on when I press the [⏻] (Power) key.	If the POWER/STANDBY indicator is not lit, the AC power cord may not be connected correctly. → <b>Make sure the AC power cord is connected correctly to the projector and the power outlet (see “Turning On the Projector”).</b>	page E-18
	If the TEMP or LIGHT indicator remains flashing or lit, it means some type of error has occurred. → <b>See “Error Indicators and Warning Messages”.</b>	User’s Guide (UsersGuide_English.pdf)
The projector does not project any image from the connected device.	The connected computer or video device may not be turned on, or it may not be outputting a video signal. → <b>Make sure the connected computer or video device is turned on, and perform the required operation on it to output a video signal.</b>	—
	The correct input source is not selected on the projector. → <b>On the projector, select the input source that corresponds to the device whose image you are trying to project (see “Selecting the Input Source”).</b>	page E-21
The projector does not correctly project the image from the connected video device.	Images may not project correctly when you have the component output terminal of a video device connected to the COMPUTER terminal of the projector. → <b>Try using the projector’s AV terminal (see “Connecting to a Standard Video Device”).</b>	page E-17
When RGB/Component is selected as the input source, the color of the projected image or the image itself is abnormal.	The wrong option (“Component” or “RGB”) may be selected for the “Input Settings → COMPUTER Terminal” setting on the setup menu. The image will not be projected correctly if “Component” is selected while the projector’s COMPUTER terminal is connected to the RGB output terminal of a computer, or if “RGB” is selected while the projector’s COMPUTER terminal is connected to the component video output terminal of a video device. → <b>Use the setup menu to change the “Input Settings → COMPUTER Terminal” setting to “Auto” to correct the problem.</b>	User’s Guide (UsersGuide_English.pdf)
I can’t understand messages or menus because they are the wrong language.	Perform the following operation to select the language you want. 1. Press the [MENU] key to display the setup menu. 2. If the input signal is HDMI, press [▼] four times and then press the [ENTER] key. If the input signal is not HDMI, press [▼] five times and then press the [ENTER] key. 3. Display the language selection menu. ● If the input signal is RGB, press [▼] six times and then press the [ENTER] key. ● If the input signal is not RGB, press [▼] five times and then press the [ENTER] key. 4. Use the [▼] and [▲] keys to move the highlighting to the language you want to select and then press the [ENTER] key. 5. Press the [MENU] key to exit the setup menu.	User’s Guide (UsersGuide_English.pdf)

## Troubleshooting

Problem	Cause and Recommended Action	See
No sound comes out of the projector after I connect it to another device.	The projector's volume level setting may be too low or muted. → <b>Press the remote controller [VOLUME] key and use [▶] and [◀] to adjust the volume level.</b>	User's Guide (UsersGuide_English.pdf)
	The volume level setting of the device connected to the computer may be too low or the other device is not outputting audio. → <b>Adjust the volume level of the connected device.</b>	Device user documentation
	The audio output of the connected device may not be connected correctly to the projector's AV terminal. → <b>Refer to one of the following (depending on the type of connected device) to check the connection.</b> "Connecting a Computer to the Projector" "Connecting to a Standard Video Device" "Connecting to a Component Video Output Device"	page E-17 page E-17 User's Guide (UsersGuide_English.pdf)
	When a video device's or computer's HDMI output is connected to the HDMI port of the projector, "Line" may be selected for the "Option Settings 2 → HDMI Audio Out" setting on the setup menu. → <b>Change the "HDMI Audio Out" setting on the setup menu to "Speaker".</b>	User's Guide (UsersGuide_English.pdf)
The color of the projected image is strange.	The input signal may not match projector settings. Try doing the following. → <b>Use the [BRIGHT] key to adjust image brightness.</b> → <b>Use the [COLOR MODE] key to change the color mode.</b> → <b>On the setup menu, use the "Image Adjustment 1 → Color Balance" setting to adjust the color balance.</b>	User's Guide (UsersGuide_English.pdf)
Text in the projected image is broken up.	The image may be out of focus. → <b>On the remote controller, use the [FOCUS ▲] and [FOCUS ▼] keys to adjust image focus.</b>	page E-21
	If text is broken up even though the image is in focus and the input source is RGB, the projector's frequency and/or phase setting may not be compatible with the input signal. → <b>Press the [AUTO] key to execute an automatic adjustment operation. If this does not correct the problem, use the setup menu to adjust the "Image Adjustment 2 → Frequency" and "Image Adjustment 2 → Phase" settings manually.</b>	page E-22 User's Guide (UsersGuide_English.pdf)
	If the input source is a video camera or document camera, check to make sure there is no problem with the input source device.	Device user documentation
The message "Please input the password." appears and further operation is not possible.	The "Option Settings 1 → Power On Password" setting on the setup menu is turned on, so the projector is password protected. → <b>Input the correct password, and then press the [ENTER] key.</b>	User's Guide (UsersGuide_English.pdf)

Problem	Cause and Recommended Action	See
The remote controller does not work.	The remote controller batteries may be dead. → <b>Replace the batteries (see “Replacing Remote Controller Batteries”).</b>	page E-13
	The remote controller may be too far from the projector. → <b>Make sure the remote controller is within the allowable range when you operate it.</b>	User’s Guide (UsersGuide_English.pdf)
The TEMP or LIGHT indicator is flashing or lit.	→ <b>See “Error Indicators and Warning Messages”.</b>	User’s Guide (UsersGuide_English.pdf)
Light source unit does not light.	The light source unit may be defective. → <b>Contact your original dealer or authorized CASIO service center for replacement.</b>	

**Important!**

- Try performing the following steps, which may or may not return the projector to normal operation.
  1. Unplug the AC power cord and wait for at least 10 minutes.
  2. Plug the power cord back in and turn the projector back on again.
- If normal operation does not resume after you perform the above steps, take the projector to your retailer or authorized CASIO service center.

# Specifications

Model Name	XJ-A130V	XJ-A135V	XJ-A230V	XJ-A235V	XJ-A140V	XJ-A145V	XJ-A240V	XJ-A245V	XJ-A150V	XJ-A155V	XJ-A250V	XJ-A255V
Brightness (ANSI Lumens)*1	2000				2500				3000			
Projection System	DLP											
DLP chip	Size: 0.55 inch, Number of Pixels: XGA (1024 × 768)	Size: 0.65 inch, Number of Pixels: WXGA (1280 × 800)	Size: 0.55 inch, Number of Pixels: XGA (1024 × 768)	Size: 0.65 inch, Number of Pixels: WXGA (1280 × 800)	Size: 0.55 inch, Number of Pixels: XGA (1024 × 768)	Size: 0.65 inch, Number of Pixels: WXGA (1280 × 800)	Size: 0.55 inch, Number of Pixels: XGA (1024 × 768)	Size: 0.65 inch, Number of Pixels: WXGA (1280 × 800)	Size: 0.55 inch, Number of Pixels: XGA (1024 × 768)	Size: 0.65 inch, Number of Pixels: WXGA (1280 × 800)	Size: 0.55 inch, Number of Pixels: XGA (1024 × 768)	Size: 0.65 inch, Number of Pixels: WXGA (1280 × 800)
Projection Lens	Optical 2X zoom, electric focus											
Light Source	Laser and LED											
COMPUTER terminal	RGB mini D-Sub 15-pin × 1 (Also used as component signal input terminal.)											
AV terminal	Audio (stereo) input/output and video input, 3.5ϕ mini jack × 1											
HDMI port	HDMI TYPE A port × 1											
USB TYPE A port	No	Yes	No	Yes	No	Yes	No	Yes	No	Yes	No	Yes
Serial port	For RS-232C control, special terminal × 1											
Wireless LAN adapter	*2	*3	*2	*3	*2	*3	*2	*3	*2	*3	*2	*3
Environment	Operating Temperature: 5 to 35°C (41 to 95°F) Operating Humidity: 20 to 80% (non-condensation) Operating Altitude: 0 to 3,000 meters (0 to 10,000 feet) above sea level											
Power	Requirements 100-240V AC, 50/60Hz, 3.3A-1.4A											
Approximate Dimensions	297 (W) × 210 (D) × 43 (H) mm (11.7" × 8.3" × 1.7")											
Weight	Approximately 2.3kg (5.1lbs)											
Display Languages	English, French, German, Italian, Spanish, Swedish, Chinese (Simplified), Chinese (Traditional), Korean, Japanese											

\*1: Compliance with ISO21118-2005

\*2: Not supported

\*3: Included (Connect to projector's special YW-3 port.)

- CASIO COMPUTER CO., LTD. makes no guarantees concerning the operation or suitability of any USB device that you connect to the projector's USB port.
- Specifications are subject to change without notice.



This mark applies in EU countries only.  
Diese Markierung trifft nur auf EU-Länder zu.  
Cette marque ne s'applique qu'aux pays de l'UE.  
Este símbolo es válido sólo en países de la UE.  
Questo marchio vale soltanto nei paesi dell'UE.  
Detta märke gäller enbart i EU-länder.

此标志仅适用于EU各国。  
此標誌僅適用於EU各國。  
본 마크는 EU 국가내에서만 적용됩니다.

## Deutsch

### Entsorgung von elektrischen & elektronischen Produkten für den Haushaltsgebrauch

(anzuwenden nur in den Ländern der Europäischen Union)

Dieses Symbol (ausgekreuzte Mülltonne) auf dem Produkt bezeichnet, dass Altgeräte usw. nicht wie normaler Haushaltsabfall in den Müll gegeben werden dürfen, sondern zum Recycling an einer hierfür vorgesehenen Annahmestelle abzugeben ist.

Für nähere Informationen wenden Sie sich bitte an die für Müllentsorgung zuständigen örtlichen Behörden. Bei unsachgemäßer Entsorgung besteht das Risiko nachteiliger Auswirkungen auf Umwelt und Gesundheit durch potentiell gefährliche Substanzen. Durch Ihre Kooperation zur ordnungsgemäßen Entsorgung fördern Sie die Wiederverwendung, das Recycling und die Rückgewinnung von Stoffen und tragen zum Umweltschutz bei.

### Entsorgung von elektrischen & elektronischen Produkten durch gewerbliche Benutzer

(anzuwenden nur in den Ländern der Europäischen Union)

Für nähere Informationen zur Entsorgung durch gewerbliche Benutzer wenden Sie sich bitte an Ihren Händler oder den zuständigen Vertrieb. Das Produkt darf nicht in den normalen Gewerbemüll gegeben werden.

## Italiano

### Smaltimento di rifiuti costituiti da prodotti elettrici e elettronici per uso domestico

(applicabile soltanto nell'Unione Europea)

Il simbolo (un bidone con ruote sbarrato da una croce) sul prodotto indica che il prodotto non deve essere mescolato o smaltito con i rifiuti domestici, alla fine della sua durata.

Questo prodotto deve essere consegnato al punto di raccolta rifiuti della propria comunità locale per il suo riciclaggio.

Per ulteriori informazioni, rivolgersi all'organo statale preposto allo smaltimento dei rifiuti nel proprio paese. Uno smaltimento dei rifiuti inappropriato può avere effetti negativi sull'ambiente e sulla salute umana a causa di sostanze potenzialmente pericolose. Collaborando allo smaltimento corretto di questo prodotto, si contribuisce al riutilizzo, al riciclaggio e al recupero del prodotto, e alla protezione del nostro ambiente.

### Smaltimento di rifiuti costituiti da prodotti elettrici e elettronici per uso commerciale

(applicabile soltanto nell'Unione Europea)

Per ulteriori informazioni riguardanti lo smaltimento di prodotti per uso commerciale, rivolgersi al proprio rivenditore o distributore nel proprio paese. Questo prodotto non deve essere mescolato o smaltito con i rifiuti commerciali.

## ENGLISH

### Disposal of Waste Electrical & Electronic Equipment of products for Household use

(Applicable in the European Union only)

The symbol (crossed out wheeled-bin) on your product indicates that the product shall not be mixed or disposed with your household waste, at their end of use.

This product shall be handed over to your local community waste collection point for the recycling of the product.

For more information, please contact your Government Waste-Disposal department in your country. Inappropriate waste handling could possibly have a negative effect on the environment and human health due to potential hazardous substances. With your cooperation in the correct disposal of this product, you contribute to reuse, recycle and recover the product and our environment will be protected.

### Disposal of Waste Electrical & Electronic Equipment of products for business use

(Applicable in the European Union only)

For further information regarding the disposal of products for business purposes, please contact your dealer or distributor in your country. This product shall not be mixed or disposed with commercial waste.

## Français

### Traitement des appareils électriques et électroniques en fin de vie par les particuliers

(Applicable dans les pays de l'Union Européenne seulement)

Ce symbole (poubelle interdite) apposé sur le produit indique qu'en fin de vie ce produit ne doit pas être traité avec les déchets ménagers.

Il doit être remis à un point de collecte approprié pour le recyclage des appareils électriques et électroniques.

Pour de plus amples informations, veuillez contacter le service de collecte des déchets ménagers local. Ce produit contient des substances potentiellement dangereuses qui peuvent avoir des effets néfastes sur l'environnement et la santé humaine. En veillant à la mise au rebut correcte de ce produit, vous contribuerez à assurer le traitement, la récupération et le recyclage de ce produit et à protéger l'environnement.

### Traitement des appareils électriques et électroniques en fin de vie par les entreprises

(Applicable dans les pays de l'Union Européenne seulement)

Pour de plus amples informations sur la collecte des déchets des professionnels, veuillez contacter votre revendeur ou distributeur local. Ce produit ne doit pas être traité avec les déchets d'entreprises.

## Español

### Disposición sobre Residuos de aparatos eléctricos y electrónicos para los productos de uso doméstico

(Aplicable sólo a la Unión Europea)

Los productos identificados con este símbolo (papelera tachada) no deben eliminarse como residuos domésticos una vez finalizada su vida útil.

Este producto debe entregarse a un punto de recogida de la comunidad local para su recuperación y reciclado.

Para mayor información, sírvase ponerse en contacto con el Departamento de Disposición de Desechos de su Ayuntamiento. El manejo inadecuado de los residuos supone riesgos para la salud humana o el medio ambiente. Con la reutilización, el reciclado de los materiales u otras formas de valorización de tales productos usted contribuye de manera importante a la protección de nuestro medio ambiente.

### Disposición de Residuos aparatos eléctricos y electrónicos para los productos de uso comercial

(Aplicable sólo a la Unión Europea)

Para mayor información sobre la disposición de productos para fines comerciales, sírvase ponerse en contacto con el concesionario o distribuidor de su país. Este producto no debe mezclarse ni desecharse junto con los residuos comerciales.

## Nederlasnds

### Afvalverwijdering van Elektrische & Elektronische Apparatuur voor Huishoudelijk Gebruik (Alleen van toepassing in de Europese Unie)

Het symbool (doorgekruisde afvalbak op wielen) op het product geeft aan dat het product aan het einde van haar levensduur niet samen met of in de vorm van huishoudafval mag worden weggegooid.

Het product moet naar een verzamelpaats (milieudepot) worden gebracht waar dergelijke producten worden gerecycled.

Neem voor meer informatie contact op met de relevante overheidsafdeling voor afval/vulnis die in uw land bestaat. Het kan nadelige gevolgen hebben op voor mens en milieu als afval op een verkeerde manier wordt behandeld waardoor potentieel schadelijke stoffen vrij komen. Door uw medewerking te verlenen en dit product op de juiste wijze wegwerpt, kunt u een bijdrage leveren aan het herstellen, hergebruiken en recycleren van dit product om zo ons milieu te beschermen.

### Afvalverwijdering van Elektrische & Elektronische Apparatuur voor Zakelijk Gebruik (Alleen van toepassing in de Europese Unie)

Voor nadere informatie aangaande het wegwerpen van producten voor zakelijke doeleinden, wordt u verzocht contact op te nemen met uw dealer of de distributeur in uw land. Dit product mag niet samen met of in de vorm van commercieel afval worden weggegooid.

## Magyar

### Házartásban használt elektromos és elektronikus készülékek hulladékként való eltávolítása

(Csak az Európai Unióban alkalmazható)

A készüléken lévő szimbólum (keresztben áthúzott kuka) azt jelzi, hogy a terméket használat után ne keverje, illetve ne helyezze el háztartási hulladékkal.

A termék újabli hasznosításra le kell adnia a kijelölt hulladékgyűjtő helyen.

További információért kérjük, forduljon az országában lévő illetékes állami hulladékeltávolítási szervhez.

Nem megfelelő hulladékkezelésnek potenciálisan veszélyes anyagok miatt negatív hatása lehet a környezetre és az emberi egészségre. A termék helyes elhelyezésében való közreműködéssel Ön hozzájárul annak újrafelhasználásához, újrafeldolgozásához és visszanyeréséhez, és védi a környezetünket.

### A gazdaságban használt elektromos és elektronikus készülékek hulladékként való eltávolítása

(Csak az Európai Unióban alkalmazható)

Az üzleti célú termékek ártalmatlanításával kapcsolatos további információért kérjük, forduljon az országában lévő kereskedőhöz vagy forgalmazóhoz. A terméket ne keverje, illetve ne helyezze el háztartási hulladékkal.

## Dansk

### Bortskaffelse af udtjent elektrisk og elektronisk udstyr i produkter til hjembrug (Gælder kun i EU)

Symbolet (en overstreget affaldsspand med hjul) på produktet angiver, at produktet ikke må blandes med eller bortskaffes sammen med almindeligt husholdningsaffald, når det er udtjent.

Produktet skal afleveres til det lokale affaldsindleveringssted til genbrug.

Kontakt venligst afdelingen for bortskaffelse af affald i din kommune angående yderligere information.

U hensigtsmæssig bortskaffelse af affald kan have en negativ virkning på miljøet og folks helbred, da det kan indeholde potentielle, farlige substanser. Med din medvirken i hensende til forskriftsmæssig bortskaffelse af dette produkt, kan du bidrage til genbrug, recirkulering og genindvinde produkterne og samtidig medvirke til, at vores miljø vil blive beskyttet.

### Bortskaffelse af udtjent elektrisk og elektronisk udstyr i produkter til forretningsbrug (Gælder kun i EU)

Kontakt venligst din forhandler eller distributør der, hvor du bor, angående yderligere information om bortskaffelse af produkter til forretningsbrug. Dette produkt må ikke blandes med eller bortskaffes sammen med kommercielt affald.

## Polski

### Usuwanie odpadów sprzętu elektrycznego & elektronicznego produktów pochodzących z gospodarstw domowych (Stosowane jedynie w Unii Europejskiej)

Symbol (przekreślony pojemnik samojedyny) na Twoim produkcie oznacza, że produkt nie powinien być mieszany lub usuwany z Twoimi odpadami pochodzącymi z gospodarstwa domowego, po jego zużyciu.

Produkt ten powinien zostać dostarczony do lokalnego komunalnego punktu zbiórki odpadów, w celu recyklingu produktu.

W celu uzyskania większej ilości informacji, prosimy o skontaktowanie się z krajowym Wydziałem Zarządzania Gospodarką Odpadami w Twoim kraju. Niewłaściwe manipulowanie odpadami może negatywnie oddziaływać na środowisko i zdrowie ludzi, wskutek potencjalnych substancji niebezpiecznych.

Współpracując przy prawidłowym usunięciu tego produktu, przyczyniasz się do ponownego użycia, recyklingu i odzysku produktu i w ten sposób nasze środowisko będzie chronione.

### Usuwanie odpadów sprzętu elektrycznego & elektronicznego produktów do użytku przedsiębiorstwa (Stosowane jedynie w Unii Europejskiej)

W celu uzyskania dalszych informacji odnośnie usuwania produktów używanych do celów przedsiębiorstwa, należy skontaktować się z Twoim sprzedawcą lub dystrybutorem w Twoim kraju. Produkt ten nie powinien być mieszany i usuwany z odpadami komunalnymi.

## Svenska

### Bortskaffning av förbrukade elektriska & elektroniska produkter för hushållsbruk

(Gäller enbart i den Europeiska Unionen)

Denna symbol (en överkorsad soptunna) på produkten innebär att produkten ej ska blandas eller slängas med ditt hushållsavfall när den är förbrukad.

Produkten ska lämnas till en lokal insamlingsplats för denna slags produkter för återvinning.

Kontakta kommunikontoret för närmare detaljer om var du finner sådana insamlingsplatser.

Olämplig avfallshantering kan få negativa effekter på miljön och på mänsklig hälsa då en produkt kan innehålla farliga ämnen. Vi ber om ditt samarbete i bortskaffningen av denna produkt för att bidra till återvinning, återanvändning och en hälsosammare miljö.

### Bortskaffning av förbrukade elektriska & elektroniska produkter för affärsbruk

(Gäller enbart i den Europeiska Unionen)

Kontakta din handlare eller distributör för närmare detaljer om bortskaffning av produkter som använts i affärsyfte. Denna produkt får inte blandas eller slängas med annat affärsavfall.

## Česky

### Nakládání s nepotřebnými domácími elektrickými a elektronickými zařízeními

(Pouze pro Evropskou unii)

Symbol (přeskrtnutá popelnice na kolečkách) na Vašem výrobku označuje, že výrobek se po ukončení jeho používání nesmí míchat a vyhazovat společně s běžným odpadem z domácnosti.

Tento výrobek je třeba odložit na určené sběrné místo ve vaší oblasti pro provedení recyklace tohoto výrobku.

Pro další informace se obraťte na místní orgány státní správy zabezpečující sběr a likvidaci odpadů. Nesprávné nakládání s odpady by mohlo mít za následek negativní vliv na životní prostředí a lidské zdraví z důvodu možného vzniku škodlivých látek. Pomocí vaší spolupráce při správném způsobu znehodnocení tohoto výrobku přispějete ke znovu využití, recyklaci a obnově výrobku přičemž naše životní prostředí bude ochráněno.

### Nakládání s nepotřebnými elektrickými a elektronickými zařízeními pro obchodní účely

(Pouze pro Evropskou unii)

Pro další informace o nakládání s odpady v podobě výrobků pro obchodní účely se obraťte na vašeho prodejce nebo distributora ve vaší zemi. Tento výrobek se nesmí míchat a vyhazovat společně s běžným obchodním odpadem.

## Português

### Eliminação de Equipamentos Eléctricos e Electrónicos para Uso Doméstico

(Aplicável somente na União Europeia)

O símbolo (caixote de lixo de rodas com uma linha cruzada) em seu produto indica que o produto, no fim da sua vida útil, não deve ser misturado ou eliminado com o lixo doméstico comum.

Este produto deverá ser entregue a uma estação de recolha de lixo da comunidade local para a reciclagem do produto.

Para mais informações, entre em contacto com o Departamento de Tratamento de Lixo do Governo do seu país.

O tratamento de lixo incorrecto poderia provocar um efeito negativo no meio ambiente e saúde humana devido a substâncias potencialmente perigosas. Com a sua cooperação para a eliminação correcta deste produto, contribuirá para a reutilização, reciclagem e recuperação do produto, e nosso meio ambiente será protegido.

### Eliminação de Equipamentos Eléctricos e Electrónicos para Uso Comercial

(Aplicável somente na União Europeia)

Para mais informações sobre a eliminação de produtos para propósitos comerciais, entre em contacto o seu revendedor ou distribuidor em seu país. Este produto não deverá ser misturado ou eliminado com lixo comercial.

## Ελληνικά

### Διάθεση Αποβλήτων Ηλεκτρικού & Ηλεκτρονικού Εξοπλισμού Οικιακής χρήσης

(Εφαρμόζεται μόνο στην Ευρωπαϊκή Ένωση)

Το σύμβολο (διαγραμμένος τροχίλατος κάδος απορριμμάτων) πάνω στο προϊόν σας υποδεικνύει ότι αυτό το προϊόν, με τη λήξη της χρήσης του, δεν πρέπει να αναμιχθεί ή να απορριφθεί μαζί με οικιακά απορρίμματα.

Αυτό το προϊόν πρέπει να παραδοθεί στο σημείο συλλογής αποβλήτων της περιοχής σας για την ανακύκλωσή του.

Για περισσότερες πληροφορίες, παρακαλείσθε να επικοινωνήσετε με τη Δημόσια Υπηρεσία Διάθεσης Αποβλήτων της χώρας σας. Η μη ορθή διαχείριση των αποβλήτων μπορεί να έχει αρνητικές επιπτώσεις στο περιβάλλον και στην ανθρώπινη υγεία λόγω της ενδεχόμενης ύπαρξης επικινδύνων ουσιών. Με τη συνεργασία σας στη σωστή διάθεση αυτού του προϊόντος, συμβάλλετε στην επαναχρησιμοποίηση, ανακύκλωση και αξιοποίηση του προϊόντος και προστατεύετε το περιβάλλον.

### Διάθεση Αποβλήτων Ηλεκτρικού & Ηλεκτρονικού Εξοπλισμού επαγγελματικής χρήσης

(Εφαρμόζεται μόνο στην Ευρωπαϊκή Ένωση)

Για περισσότερες πληροφορίες σχετικά με τη διάθεση των προϊόντων που προορίζονται για επαγγελματική χρήση, παρακαλείσθε να επικοινωνήσετε με τον έμπορο ή τον αντιπρόσωπο της χώρας σας. Αυτό το προϊόν δεν πρέπει να αναμιχθεί ή να απορριφθεί μαζί με αποβλήτα εμπορικής προέλευσης.

## Slovenščina

### Odlaganje odpadkov električne in elektronske opreme izdelkov za gospodinjstvo

(Uporabno samo v Evropski Uniji)

Oznaka (prekrižan smetnjak na kolesih) na vašem izdelku označuje, da se tega izdelka po končani uporabi ne sme mešati ali odvračati z ostalimi gospodinjstvenimi odpadki.

Ta izdelek je potrebno oddati vaši lokalni deponiji z odpadki za predelavo takšnih izdelkov.

Za podrobnejše podatke se obrnite na državni urad za odstranjevanje odpadkov v vaši državi.

Zaradi nevarnih snovi ima lahko napravo upravljanje z odpadki negativne posledice na okolje in zdravje ljudi. Z vašim sodelovanjem pri pravilnem odstranjevanju tega izdelka, pripomorete k ponovni uporabi, recikliranju in nadomestitvi izdelka. Naše okolje bo tako zavarovano.

### Odlaganje odpadkov električne in elektronske opreme izdelkov za poslovno uporabo

(Uporabno samo v Evropski Uniji)

Za podrobnejše podatke od odstranjevanju izdelkov za poslovno uporabo, se obrnite na prodajalca ali dobavitelja v vaši državi. Tega izdelka se ne sme mešati ali odvračati z ostalimi komercialnimi odpadki.

## Suomi

### Sähkö- ja elektroniikkatuotteiden hävitysohjeet kotitalouksia varten

(Vain Euroopan Unionia varten)

Tuotteeseen merkitty symboli (ylitse ruksattu jätessäiliö) osoittaa, että tuotetta ei saa sekoittaa eikä hävittää talousjätteiden kanssa.

Tuote on luovutettava sopivaan tällaisten laitteiden kierrätyksestä huolehtivaan hävityspisteeseen.

Pyydä lisätietoja jätteasioista vastaavilta paikallisilta viranomaisilta. Tämän tuotteen asianmukaisen hävittämisen varmistamisella autetaan estämään sen mahdolliset ympäristön ja terveyteen kohdistuvat haittavaikutukset, joita voi aiheutua muussa tapauksessa tämän tuotteen epäasianmukaisesta käsittelystä. Hävittämällä tuotteen asianmukaisesti autat varmistamaan, että tuote uudelleenkäytetään, kierrätetään ja kerätään ja ympäristöä suojellaan.

### Sähkö- ja elektroniikkatuotteiden hävitysohjeet yrityskäyttäjille

(Vain Euroopan Unionia varten)

Lisätietoja tuotteiden hävitysohjeista yrityskäyttäjille antavat jälleenmyyjät tai edustajat kussakin maassa. Tätä tuotetta ei saa sekoittaa eikä hävittää kaupallisten jätteiden kanssa.

## Slovenčina

### Likvidácia elektrického a elektronického zariadenia výrobnou určených pre domáce použitie

(platné len v Európskej Únii)

Symbol (prečiarknutý odpadkový kôš) na výrobku znamená, že daný výrobok nie je možné po skončení používania zmiešať a vyhodiť spolu s bežným domácim odpadom.

Výrobok je nutné odovzdať do zberne odpadu vo vašej lokalite, kde dôjde k jeho recyklácii.

Presné informácie Vám poskytne úrad štátnej správy zodpovedný za zber a likvidáciu odpadu.

Nesprávna likvidácia odpadu môže mať negatívny dopad na životné prostredie a ohroziť ľudské zdravie nebezpečnými látkami. Naopak správny postupom pri likvidácii odpadu umožní jeho opätovné použitie, recykláciu a obnovenie výrobku, čím prispějete k ochrane životného prostredia.

### Likvidácia elektrického a elektronického zariadenia výrobnou určených pre priemyselné použitie

(platné len v Európskej Únii)

Presnejšie informácie oľhľadom likvidácie odpadov výrobnou určených pre priemyselné použitie Vám poskytne predajca alebo distribútor vo Vašej krajine. Výrobok by nemal byť zmiešaný a vyhodnený spolu s ostatným priemyselným odpadom.

## Lietuvių

### Elektros ir elektroninės įrangos, naudotos buityje, šalinimas

(galioja tik Europos Sąjungoje)

Simbolis (perbraukta šiukšlių dėžė su ratukais), esantis ant jūsų įsigytos įrangos, reiškia, kad įrangą, pasibaigus jos naudojimui, negali būti maišoma ar šalinama kartu su buitinėmis atliekomis.

Tokia įranga turi būti perduota jūsų vietos bendruomenės atliekų surinkimo centrui, kad būtų panaudota kaip antrinė žaliava.

Daugiau informacijos galite gauti jūsų šalies vyriausybės atliekų tvarkymo departamente.

Netinkamas atliekų šalinimas gali neigiamai veikti aplinką ir žmonių sveikatą, nes atliekose gali būti pavojingų medžiagų. Teisingai šalinami šią įrangą, jus prisidedate prie pakartotinio įrangos panaudojimo, perdūrimo ir regeneracijos ir taip apsaugote aplinką.

### Elektras ir elektroninės įrangos, naudotos komercinėje veikloje, šalinimas

(galioja tik Europos Sąjungoje)

Daugiau informacijos apie komercinėje veikloje naudotos įrangos šalinimą galite gauti iš prekybininkų ar platintojų jūsų šalyje. Ši įranga negali būti maišoma ar išmetama kartu su komercinėmis atliekomis.



## Eesti

### Kodusse majapidamises kasutuskölbmatuks muutunud elektri- ja elektroonikatarvete kõrvaldamisest.

(Kehtiv vaid Euroopa Ühenduse liikmesriikides)

Sümbol (ristiga maha tõmmatud vagun) tootel osutab, et käesolevat toodet ei tohi peale selle kasutuskölbmatuks muutmist visata ära koos muu majapidamises tekkiva prüügiga.

Käesolev toode on ümbertöödeldav ning tuleb viia kohaliku prügikogumis- või ümbertöötlemiskeskusesse.

Täpsema informatsiooni saamiseks palume pöörduda selle riigiasutuse poole Teie riigis, mis tegeleb prügimajandusse puutuvate regulatsioonidega.

Käesoleva toote vale käsitlemine selle kõrvaldamisel võib põhjustada võimalikest riskiainetest tulenevat negatiivset mõju nii keskkonnale kui ka Teie tervisele. Toote korrektne käsitlemine ka peale selle kasutuskölbmatuks muutmist ja Teie kaasabi käesoleva toote kordvkasutusse või ümbertöötlusesse saatmisel avab Teile lisavõimaluse kaitssta ühist looduskeskkonda.

### Kasutuskölbmatuks muutunud elektri- ja elektroonikatarvete kõrvaldamisest firmades ja asutustes.

(Kehtiv vaid Euroopa Ühenduse liikmesriikides)

Täpsemate juhiste hankimiseks palume pöörduda Teie riigis asuva edasimüüja või vahendaja poole. Käesolevat toodet ei ole lubatud ära visata koos muu prüügiga.

## Latviešu

### Atbrīvošanās no Elektriskajiem Atkritumiem un Elektroniskām Mājsaimniecību Ierīcēm

(Direktīva ir spēkā tikai Eiropas Savienībā)

Simbols (pārsvītrotā atkritumu tvertne), uz jūsu produkta, nozīmē, ka produktu nedrīkst izmest, pēc derīguma termiņa beigām, kopā ar parastajiem mājās atkritumiem.

Šis produkts tiks nodots vietējā kārtīgo atkritumu savākšanas punktā tā pārstrādāšanai.

Lai iegūtu plašāku informāciju, lūdzu, sazinieties ar jūsu Valsts atkritumu pārstrādes nodaļu.

Nepareiza atbrīvošanas no šī produkta var atstāt negatīvu ietekmi uz apkārtējo vidi un cilvēku Veselību potenciālā kaitīgā sastāva dēļ. Ar jūsu sadarbību šī produkta pareizā pārstrādē, jūs palīdzas aizsargāt apkārtējo vidi un atbalstāt produktu vairākkārtēju izmantošanu.

### Atbrīvošanās no Elektroniskajiem Atkritumiem un Elektroniskā ekpējuma biznesa klases produktiem

(Direktīva ir spēkā tikai Eiropas Savienībā)

Lai iegūtu plašāku informāciju par biznesa klases produktu pārstrādi, griezieties pie vietējā izplatītāja vai pārdevēja jūsu valstī. Šo produktu nedrīkst izmest kopā ar tirdzniecības atkritumiem.

## Malti

### Skart ta' Prodotti Elettriċi u Elettronīċi għal użu Domestiku

(Applikabbli biss fl-Unjoni Ewropea)

Is-simbolu (*wheeled-bin* maqtugh) fuq il-prodott tieghek jindika li l-prodott m'għandux jiġi imħallat jew mormi ma' skart domestiku.

Dan il-prodott għandu jiġi rritornat lill-aġenzija li tiehu hsieb il-ġbir ta' skart domestiku fil-komunita' tieghek, sabieix jiġi riċiklat.

Għal aktar informazzjoni int mitlub tikkuntattja il-Government Waste Disposal department f' pajjizek.

Minħabba xi kimiċi, jekk dan il-prodott ma jiġix skartat kif indikat, jista' ikun hemm effetti negattivi fuq l-ambjent u s-saħħa. Bil-koperazzjoni tieghek fil-skart ta' dan il-prodott tkun qed tikkontribwixxi għall-protezzjoni tal-ambjent tagħna lkoll.

### Skart ta' Prodotti Elettriċi u Elettronīċi għal użu Kummerċjali

(Applikabbli biss fl-Unjoni Ewropea)

Tista' tikseb aktar informazzjoni dwar kif għandek tiddispondi minn dan il-tip ta' skart mingħand id-distributur lokali ta' dan il-prodott. Meta jiġi mormi, dan il-prodott m'għandux jiġi mħallat ma' tipi ta' skart kummerċjali oħra.

**GUIDELINES LAID DOWN BY FCC RULES FOR USE OF THIS UNIT IN THE U.S.A. (not applicable to other areas).**

**NOTICE**

This equipment has been tested and found to comply with the limits for a Class B digital device, pursuant to Part 15 of the FCC Rules. These limits are designed to provide reasonable protection against harmful interference in a residential installation. This equipment generates uses and can radiate radio frequency energy and, if not installed and used in accordance with the instructions, may cause harmful interference to radio communication. However, there is no guarantee that interference will not occur in a particular installation. If this equipment does cause harmful interference to radio or television reception, which can be determined by turning the equipment off and on, the user is encouraged to try to correct the interference by one or more of the following measures:

- Reorient or relocate the receiving antenna.
- Increase the separation between the equipment and receiver.
- Connect the equipment into an outlet on a circuit different from that to which the receiver is connected.
- Consult the dealer or an experienced radio/TV technician for help.

**FCC WARNING**

Changes or modifications not expressly approved by the party responsible for compliance could void the user's authority to operate the equipment.

Proper connectors must be used for connection to host computer and/or peripherals in order to meet FCC emission limits.

Connector cable....XJ-A130V/XJ-A135V/XJ-A140V/XJ-A145V/XJ-A150V/XJ-A155V/XJ-A230V/  
XJ-A235V/XJ-A240V/XJ-A245V/XJ-A250V/XJ-A255V unit to PC

**Declaration of Conformity**

Model Number: XJ-A130V/XJ-A135V/XJ-A140V/XJ-A145V/XJ-A150V/XJ-A155V/XJ-A230V/  
XJ-A235V/XJ-A240V/XJ-A245V/XJ-A250V/XJ-A255V

Trade Name: CASIO COMPUTER CO., LTD.

Responsible party: CASIO AMERICA, INC.

Address: 570 MT. PLEASANT AVENUE, DOVER, NEW JERSEY 07801

Telephone number: 973-361-5400

This device complies with Part 15 of the FCC Rules, Operation is subject to the following two conditions:

(1) This device may not cause harmful interference, and (2) this device must accept any interference received, including interference that may cause undesired operation.

## FCC Information

This device, IEEE 802.11g Wireless LAN USB Adapter, complies with Part 15 of the FCC Rules. Operation is subject to the following two conditions: (1) this device may not cause harmful interference, and (2) this device must accept any interference received; including interference that may cause undesired operation.

### Federal Communications Commission (FCC) Statement

This Equipment has been tested and found to comply with the limits for a Class B digital device, pursuant to Part 15 of the FCC rules. These limits are designed to provide reasonable protection against harmful interference in a residential installation. This equipment generates, uses and can radiate radio frequency energy and, if not installed and used in accordance with the instructions, may cause harmful interference to radio communications. However, there is no guarantee that interference will not occur in a particular installation. If this equipment does cause harmful interference to radio or television reception, which can be determined by turning the equipment off and on, the user is encouraged to try to correct the interference by one or more of the following measures:

- Reorient or relocate the receiving antenna.
- Increase the separation between the equipment and receiver.
- Connect the equipment into an outlet on a circuit different from that to which the receiver is connected.
- Consult the dealer or an experienced radio/TV technician for help.

**Warning: Changes or modifications to this unit not expressly approved by the party responsible for compliance could void the user authority to operate the equipment.**

Tested to comply with FCC standard. FOR HOME OR OFFICE USE.



### FCC RF Radiation Exposure Statement:

1. This equipment complies with FCC RF radiation exposure limits set forth for an uncontrolled environment, under 47 CFR 2.1093 paragraph (d)(2).
2. This Transmitter must not be co-located or operating in conjunction with any other antenna or transmitter.

The **IEEE 802.11g Wireless LAN USB Adapter** has been tested to the FCC exposure requirements (Specific Absorbion Rate).



#### FOR CALIFORNIA USA ONLY

Perchlorate Material – special handling may apply.  
See [www.dtsc.ca.gov/hazardouswaste/perchlorate](http://www.dtsc.ca.gov/hazardouswaste/perchlorate).

This Class B digital apparatus complies with Canadian ICES-003.  
Cet appareil numérique de la classe B est conforme à la norme NMB-003 du Canada.

## レーザーに関するご注意

- 本機は、IEC 60825-1 に適合したクラス1 レーザー製品です。
- 本機はレーザーモジュールを内蔵しています。分解・改造は危険ですので行わないでください。
- 取扱説明書に指定した以外の手順で操作や調整を行うと、危険なレーザー放射にさらされる原因となることがあります。

## Laser Precautions

- This projector is a Class 1 laser device that conforms with IEC 60825-1.
- This projector has a built-in laser module. Disassembly or modification is very dangerous and should never be attempted.
- Any operation or adjustment not specifically instructed by the user's guide creates the risk of hazardous laser radiation exposure.

## Vorsichtsmaßregeln zum Laser

- Dieser Projektor ist ein mit IEC 60825-1 konformes Lasergerät der Klasse 1.
- Dieser Projektor besitzt ein eingebautes Lasermodul. Ein Zerlegen oder Modifizieren ist sehr gefährlich und sollte auf keinen Fall versucht werden.
- Wenn das Gerät anders als in der Bedienungsanleitung angewiesen betrieben oder eingestellt wird, besteht die Gefahr, sich gefährlicher Laserstrahlung auszusetzen.

## Précautions concernant le laser

- Ce projecteur est un dispositif laser de Classe 1 conforme à la norme IEC 60825-1.
- Ce projecteur intègre un module laser. Ne jamais essayer de démonter ou modifier ce module car ceci est très dangereux.
- Toute opération ou tout réglage non mentionné spécifiquement dans le mode d'emploi crée un risque d'exposition dangereuse aux radiations du laser.

## Precauciones sobre el láser

- Este proyector es un dispositivo láser de Clase 1 que cumple con la norma IEC 60825-1.
- Este proyector cuenta con un módulo láser incorporado. El desarmado o modificación puede resultar muy peligroso y nunca debe intentarlo.
- Cualquier operación o ajuste no indicado específicamente en la guía del usuario crea el riesgo de exposición a radiación láser peligrosa.

## Precauzioni per il laser

- Questo proiettore è un dispositivo laser di classe 1 che è conforme a IEC 60825-1.
- Questo proiettore è dotato di un modulo laser incorporato. Lo smontaggio o la modifica è molto pericoloso e non deve essere tentato.
- Qualsiasi operazione o regolazione non specificatamente istruita dalla guida dell'utilizzatore, crea il rischio di esposizione a radiazione laser pericolosa.

## Att observera angående laser

- Denna projektor är en laserapparat av klass 1 i enlighet med IEC 60825-1.
- Projektorn har en inbyggd lasermodul. Isärtagning eller modifiering är mycket farligt och bör aldrig försöka göras.
- En manövrering eller justering som inte specifikt anges i instruktionshäftet skapar risk för exponering för farlig laserstrålning.

## 激光須知

- 本投影机為符合 IEC 60825-1 的 1 類激光裝置。
- 本投影机內置激光模塊。拆解或改造投影机是極為危險的，切勿進行嘗試。
- 進行本用戶說明書未說明的任何操作或調整都有造成有害激光輻射的危險。

## 激光須知

- 本投影机为符合 IEC 60825-1 的 1 类激光装置。
- 本投影机内置激光模块。拆解或改造投影机是极为危险的，切勿进行尝试。
- 进行本用户说明书未说明的任何操作或调整都有造成有害激光辐射的危险。

## 레이저 주의사항

- 본 프로젝터는 IEC 60825-1에 따르는 클래스1 레이저 장치입니다.
- 본 프로젝터에는 레이저 모듈이 내장되어 있습니다. 분해 또는 개조는 매우 위험하므로 절대로 해서는 안됩니다.
- 사용설명서에서 특별히 지정하지 않은 조작 또는 조정을 하면 위험한 레이저에 노출될 위험이 있습니다.

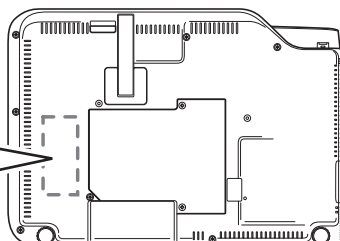

**[底面]**  
**[Bottom]**  
**[Unterseite]**  
**[Dessous]**  
**[Parte interior]**  
**[Fondo]**  
**[Undersida]**  
[ 底部 ]  
[ 底部 ]  
[ 저면 ]

**HDMI**<sup>®</sup>  
HIGH-DEFINITION MULTIMEDIA INTERFACE

EEE Yönetmeliğine Uygundur



Manufacturer:  
CASIO COMPUTER CO.,LTD.  
6-2, Hon-machi 1-chome, Shibuya-ku, Tokyo 151-8543, Japan  
Responsible within the European Union:  
CASIO EUROPE GmbH  
Casio-Platz 1, 22848 Norderstedt, Germany

**CASIO®**

**カシオ計算機株式会社**

〒151-8543 東京都渋谷区本町1-6-2

**CASIO COMPUTER CO.,LTD.**

6-2, Hon-machi 1-chome  
Shibuya-ku, Tokyo 151-8543, Japan