

fx-8200 AU

User's Guide

CASIO Worldwide Education Website

<https://edu.casio.com>

Manuals are available in multi languages at

<https://world.casio.com/manual/calc/>

Table of Contents

| | |
|--|-----------|
| Before Using the Calculator | 5 |
| Read This First | 5 |
| About This Manual | 5 |
| Key Operations | 5 |
| Menu Operations | 6 |
| Ⓚ Key and ⓧ Key | 7 |
| Examples | 7 |
| Initializing the Calculator | 7 |
| Calculator "Get Started" Screen | 7 |
| Precautions | 8 |
| Safety Precautions | 8 |
| Handling Precautions | 9 |
| Getting Started | 10 |
| Attaching and Removing the Front Cover | 10 |
| Turning Power On and Off | 11 |
| HOME Screen | 12 |
| Adjusting Display Contrast | 12 |
| Key Markings | 12 |
| Indicators | 13 |
| Using Menus | 13 |
| Calculator Apps and Menus | 16 |
| Calculator Apps | 16 |
| Selecting a Calculator App | 16 |
| Installed Calculator App List | 16 |
| Using the SETTINGS Menu | 17 |
| Changing Calculator Settings | 18 |
| Items and Available Setting Options | 19 |
| Using the CATALOG Menu | 23 |
| Using the TOOLS Menu | 23 |
| Inputting Expressions and Values | 25 |
| Basic Input Rules | 25 |
| Inputting an Expression Using Natural Textbook Format (MathI/MathO or MathI/DecimalO Only) | 26 |
| Undo Operations | 27 |
| Using Values and Expressions as Arguments | 27 |
| Overwrite Input Mode (LineI/LineO or LineI/DecimalO Only) | 27 |
| Basic Calculations | 28 |
| Arithmetic Calculations | 28 |
| Fraction Calculations | 28 |
| Powers, Power Roots, and Reciprocals | 30 |

| | |
|---|-----------|
| Pi, Natural Logarithm Base e | 32 |
| Pi | 32 |
| Natural Logarithm Base e | 32 |
| Calculation History and Replay | 32 |
| Calculation History | 32 |
| Replay | 33 |
| Using Memory Functions | 33 |
| Answer Memory (Ans) / Previous Answer Memory (PreAns) | 33 |
| Variables (A, B, C, D, E, F, x, y, z) | 35 |
| Clearing the Contents of All Memories | 37 |
| Changing Calculation Result Format | 38 |
| Using the FORMAT Menu | 38 |
| FORMAT Menu List | 38 |
| Conversion Sample Operation | 39 |
| Standard and Decimal Conversion | 39 |
| Prime Factorization | 40 |
| Recurring Decimal Conversion (Recurring Decimal Calculations) | 41 |
| Converting a Calculation Result to a Recurring Decimal Value | 41 |
| Inputting a Recurring Decimal | 41 |
| Recurring Decimal Calculation Example | 42 |
| Rectangular and Polar Coordinate Conversion | 43 |
| Improper Fraction and Mixed Fraction Conversion | 43 |
| Engineering Notation | 43 |
| Sexagesimal Conversion (Degree, Minute, Second Calculations) | 45 |
| Converting a Decimal Value Calculation Result to a Sexagesimal Value | 45 |
| Inputting and Calculating with a Sexagesimal Value | 45 |
| Advanced Calculations | 46 |
| Function Analysis | 46 |
| Summation(Σ) | 46 |
| Product(Π) | 47 |
| Logarithm(\log_{ab}), Logarithm(\log) | 48 |
| Natural Logarithm | 49 |
| Probability | 49 |
| % | 49 |
| Factorial(!) | 49 |
| Permutation(P), Combination(C) | 50 |
| Random Number | 50 |
| Random Integer | 50 |
| Numeric Calculations | 51 |
| GCD, LCM | 51 |
| Absolute Value | 51 |
| Recurring Decimal | 51 |
| Round Off | 52 |
| Angle Unit, Polar/Rectangular Coordinate, Sexagesimal | 52 |
| Degrees, Radians, Gradians | 52 |

| | |
|---|-----------|
| Rect to Polar, Polar to Rect | 53 |
| Degrees, Minutes, Seconds | 53 |
| Hyperbolic, Trigonometric | 54 |
| Hyperbolic Functions | 54 |
| Trigonometric Functions | 54 |
| Others | 55 |
| Registering and Using Defining Equations for $f(x)$ and $g(x)$ | 56 |
| | |
| Registering and Using Defining Equations for $f(x)$ and $g(x)$ | 56 |
| Registering a Defining Equation | 56 |
| Performing a Calculation by Assigning a Value to the Registered Defining Equation | 57 |
| Registering a Composite Function | 57 |
| Data Retention | 58 |
| Using Verify | 59 |
| Verify Overview | 59 |
| Enabling and Disabling Verify | 59 |
| Using Verify with the Calculate App | 60 |
| Verify Sample Operation | 60 |
| Verifiable Expressions | 61 |
| Performing a Sequential Verification Operation on the Right Side of an Expression | 61 |
| Using QR Code Functions | 63 |
| Using QR Code Functions | 63 |
| Displaying a QR Code | 63 |
| If You Experience Difficulty Scanning a QR Code | 64 |
| Using Calculator Apps | 65 |
| Statistical Calculations | 65 |
| General Procedure for Performing a Statistical Calculation | 65 |
| Inputting Data with Statistics Editor | 66 |
| Displaying Statistical Calculation Results | 69 |
| Using Statistical Calculation Screen | 73 |
| Statistical Calculation Formula | 78 |
| Distribution Calculations | 81 |
| General Procedure for Performing a Distribution Calculation | 81 |
| Parameter List | 83 |
| List Screen | 84 |
| Editing the List Screen Contents | 85 |
| Calculation Example | 85 |
| Creating a Number Table | 86 |
| General Procedure for Creating a Number Table | 86 |
| Maximum Number of Rows in a Number Table According to Table Type | 87 |
| Defining Equation Registration | 88 |
| Editing Number Table Screen Data | 88 |

| | |
|---|------------|
| $f(x)$ and $g(x)$ Update Timing | 89 |
| Using Verify with the Table App | 89 |
| Data Retention | 91 |
| Complex Number Calculations | 92 |
| Inputting Complex Numbers | 92 |
| Complex App Calculation Examples | 92 |
| Using Verify with the Complex App | 94 |
| Vector Calculations | 95 |
| General Procedure for Performing a Vector Calculation | 95 |
| Vector Variable List Screen | 97 |
| Vector Answer Memory (VctAns) | 99 |
| Vector Calculation Examples | 100 |
| Technical Information | 102 |
| Errors | 102 |
| Displaying the Location of an Error | 102 |
| Error Messages | 102 |
| Before Assuming Malfunction of the Calculator... .. | 105 |
| Replacing the Battery | 105 |
| Calculation Priority Sequence | 107 |
| Calculation Ranges, Number of Digits, and Precision | 108 |
| Calculation Range and Precision | 108 |
| Function Calculation Input Ranges and Precision | 108 |
| Specifications | 110 |
| Frequently Asked Questions | 112 |
| Frequently Asked Questions | 112 |

Before Using the Calculator

Read This First

About This Manual

- In no event shall CASIO Computer Co., Ltd. be liable to anyone for special, collateral, incidental, or consequential damages in connection with or arising out of the purchase or use of this product and items that come with it. Moreover, CASIO Computer Co., Ltd. shall not be liable for any claim of any kind whatsoever by any other party arising out of the use of this product and the items that come with it.
- The contents of this manual are subject to change without notice.
- The displays and illustrations (such as key markings) shown in this manual are for illustrative purposes only, and may differ somewhat from the actual items they represent.
- QR Code is a registered trademark of DENSO WAVE INCORPORATED in Japan and in other countries.
- Company and product names used in this manual may be registered trademarks or trademarks of their respective owners.

Key Operations

The example below shows how key operations are represented in this manual.

Example 1: AC $\sqrt{\square}$ 9 EXE

Keys should be pressed in the sequence shown above (left to right).

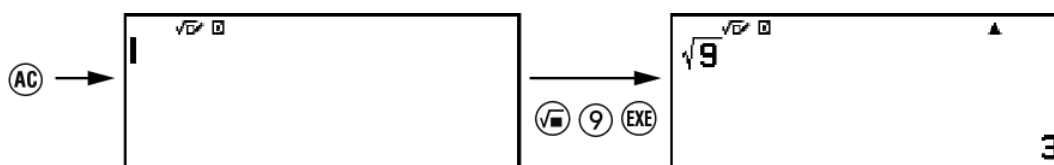

Example 2: \uparrow 7 $(\pi)^*$

The above indicates you should press \uparrow and then 7 , which will input a π symbol. All multiple-key input operations are indicated like this. Key cap markings are shown, followed by the input character or command in parentheses.

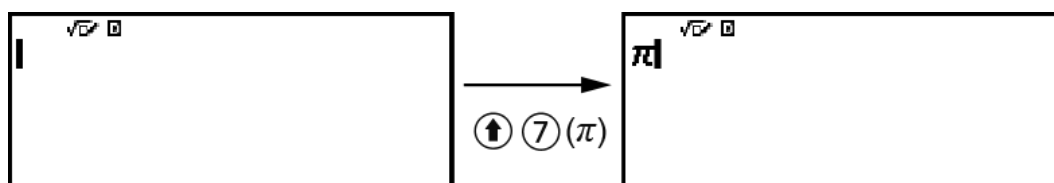

* Refer to "**Key Markings**" (page 12) for more information about the key symbols used in this example.

Example 3: ⤴, ⤵, ⤶, ⤷, ⤸, ⤹

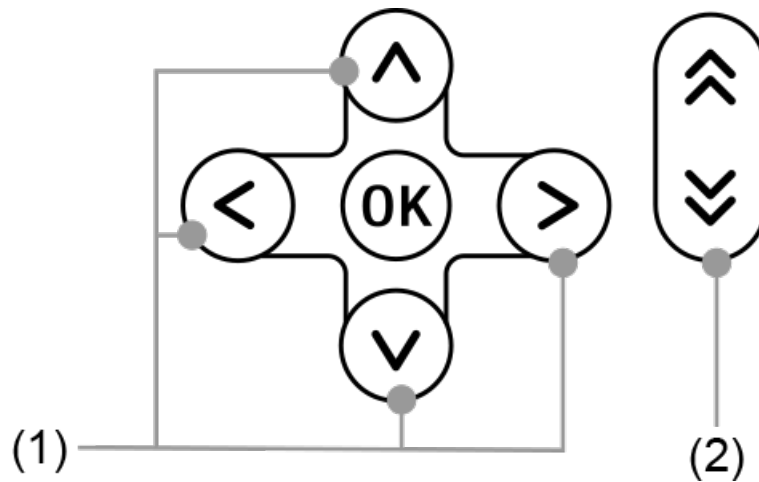

- Individual cursor keys indicated by (1) are represented as ⤴, ⤵, ⤶, ⤷.
- Individual page scroll keys indicated by (2) are represented as ⤸, ⤹.

Menu Operations

Some operations in this manual use a simplified form of menu operations, as shown in the examples below.

Example 1

⊞ – [Other] > [π]

or

Press ⊞, and then select [Other] > [π].



Actual Operation 1

1. Press ⊞.
2. Use ⤴ and ⤵ to select [Other], and then press OK.
3. Use ⤴ and ⤵ to select [π], and then press OK.







Example 2

⊞ - Calculate









or

Press , select the Calculate app icon, and then press .

Actual Operation 2

1. Press .
2. Use the cursor keys (, , , ) to select the Calculate app icon, and then press .

Key and Key

The  key and  key perform the same operation. In this manual,  is used for selecting or applying a setting, while  is used for executing a calculation. Note, however, that it makes no difference whether you press  or  for operations where either  or  is shown.

Examples

If you are not instructed to use a specific calculator app or to configure particular settings for an example operation, the app and settings below are assumed.

Calculator app: Calculate







Settings: Initial default calculator settings

For information about returning the calculator to its initial default settings, see ["Initializing the Calculator" \(page 7\)](#).

Initializing the Calculator

Important!

- The procedure below initializes all calculator settings, except for Contrast and Auto Power Off. Also clears all data stored in calculator memory.

1. Press  to display the HOME screen.
2. Use the cursor keys (, , , ) to select a calculator app icon, and then press .
3. Press , and then select [Reset] > [Initialize All] > [Yes].
 - This displays the HOME screen.

Calculator "Get Started" Screen

While the HOME screen is displayed, pressing the  key will display the "Get Started" screen, which includes the information below.

- QR Code for accessing the "Get Started" webpage of the Worldwide Education Service (<https://wes.casio.com/calc/cw/>)
The Get Started webpage gives you access to the User's Guide and other related information to help you get started with your calculator.
- Calculator ID number (24-character string)

Press  to return to the HOME screen.

Note

- You can also display the Get Started screen, by selecting it from the SETTINGS menu.
See "[Using the SETTINGS Menu](#)" (page 17).

Precautions

Safety Precautions

Thank you for purchasing this CASIO product.

Be sure to read the "Safety Precautions" before using this product to ensure that you use it correctly. Be sure to keep all user documentation handy for future reference.

Warning

Indicates something that creates the risk of death or serious personal injury.

■ Display Screen

 **Do not press the LCD or subject it to strong impact.**

Doing so can cause the LCD glass to crack, creating the risk of personal injury.

 **Should the LCD become cracked, never touch any of the liquid inside.**

LCD liquid getting on the skin creates the risk of skin irritation.

Should LCD liquid get into your mouth, immediately rinse your mouth out and contact your physician.

Should LCD liquid get in your eyes or on your skin, rinse with clean water and then contact your physician.

■ Battery Precautions



Should fluid leaking from a battery get on your skin or clothing, immediately rinse it off with clean water.

Battery fluid getting into the eyes creates the risk of eyesight loss, etc. Rinse the eyes and then immediately contact a physician.



Caution

Indicates something that creates the risk of minor personal injury or physical damage.

Observe the precautions below. Failure to do so can cause a battery to rupture, creating the risk of fire, personal injury, and soiling of nearby objects by leaking fluid.



- Do not try to take a battery apart and never allow a battery to become shorted.
- Do not charge a non-rechargeable battery.
- Do not expose a battery to heat or throw it into fire.



- Use only the specified type of battery.
- Load a battery with its poles (plus (+) and minus (-)) facing correctly.
- Replace the battery as soon as possible after it goes dead.



Battery Precautions



Observe the precautions below. Failure to do so can cause the battery to explode or leak flammable liquid or gas.

- Use only the type of battery that is specified for this product.
- Do not burn a battery or dispose of it in an incinerator, or by mechanical crushing or cutting.
- Do not subject a battery to excessively high or low temperatures during use, storage, or transport.
- Do not subject a battery to excessively low barometric pressure during use, storage, or transport.

■ Handling Precautions

- Even if the calculator is operating normally, replace the battery at least once every two years (R03).

- You will be charged for malfunction or damage due to battery leakage, which is not covered by the warranty.
- The battery that comes with the calculator discharges slightly during shipment and storage. Because of this, it may require replacement sooner than the normal expected battery life.
- Avoid use and storage of the calculator in areas subjected to temperature extremes, and large amounts of humidity and dust.
- Do not subject the calculator to excessive impact, pressure, or bending.
- Never try to take the calculator apart.
- Use a soft, dry cloth to clean the exterior of the calculator.
- Whenever discarding the calculator or batteries, be sure to do so in accordance with the laws and regulations in your particular area.

Getting Started

Attaching and Removing the Front Cover

To remove the front cover

Before using the calculator, remove the front cover (①) and attach it to the back (②).

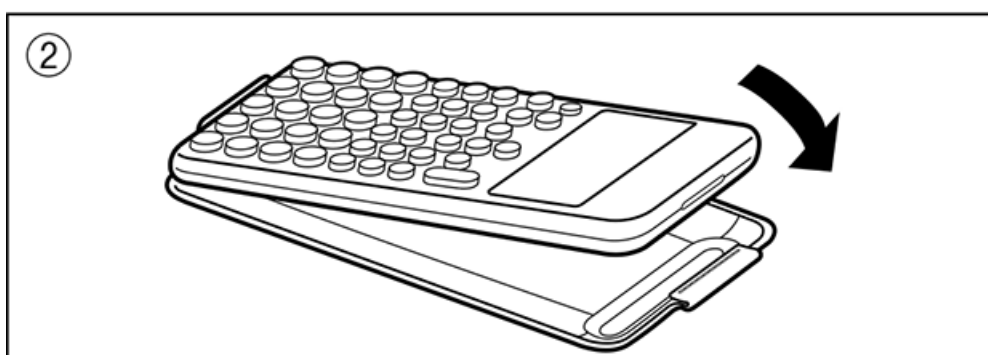
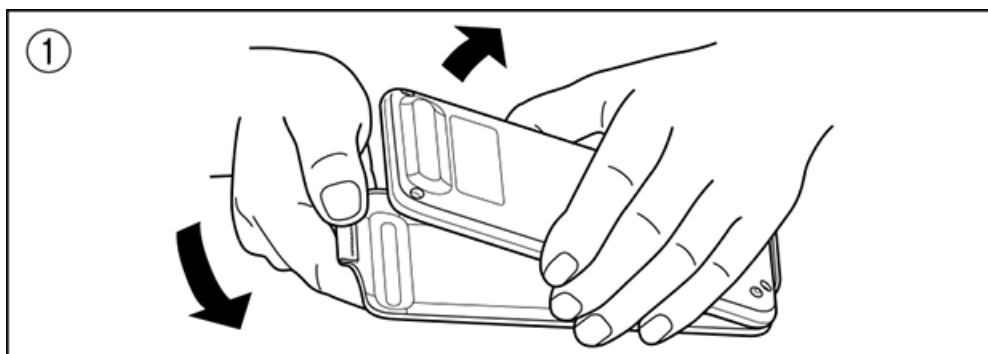

To attach the front cover

When you are not using the calculator, remove the front cover (①) and attach it to the front (②).

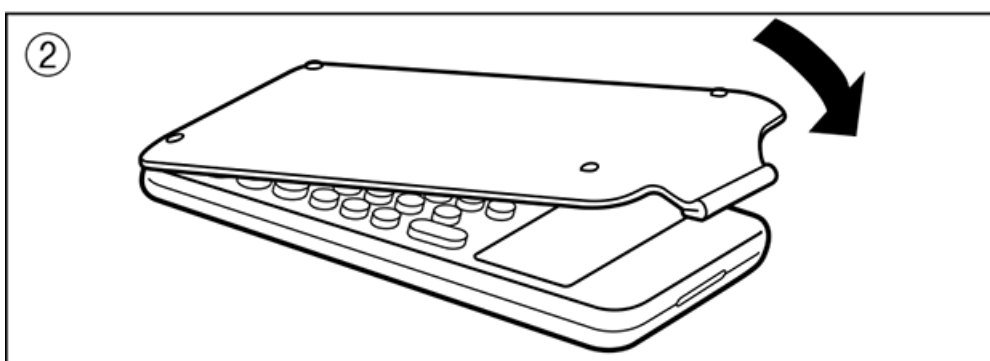
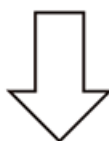
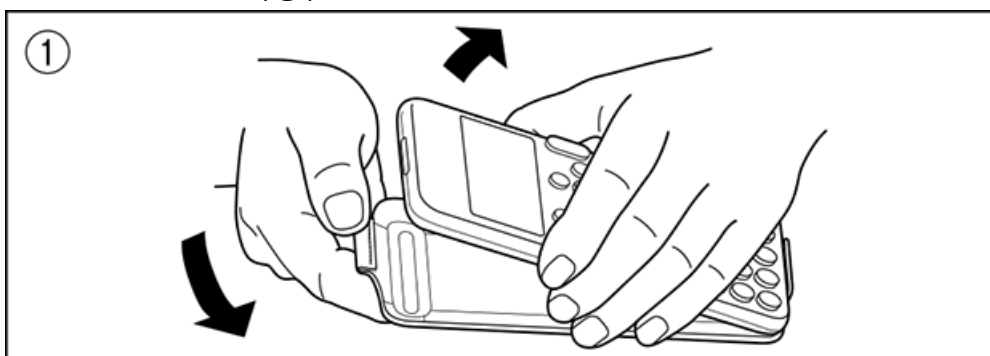

Important!



- Always attach the front cover to the calculator whenever you are not using it. Otherwise, accidental operation of the  key can cause the power to turn on and run down the battery.

Turning Power On and Off

Press  to turn on the calculator.

Press  (AC) (OFF) to turn off the calculator.

Note

- To turn on power, long-press . To avoid turning on power accidentally, the top of  key is slightly lower than the other keys.
- If the screen shown below appears right after you turn on power, it means that remaining battery power is low.



If this screen appears, replace the battery as soon as possible. For details about battery replacement, see ["Replacing the Battery" \(page 105\)](#).

- The calculator also will turn off automatically after approximately 10 minutes or 60 minutes of non-use. Press the \odot key to turn the calculator back on.

HOME Screen

Pressing \odot displays the HOME screen. The HOME screen shows a list of installed calculator apps.

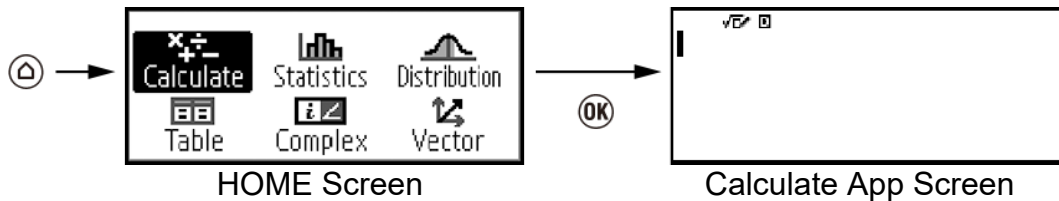

For information about installed calculator apps, see ["Installed Calculator App List" \(page 16\)](#).

Adjusting Display Contrast

1. Press \odot , select a calculator app icon, and then press OK .
2. Press Menu , and then select [System Settings] > [Contrast].

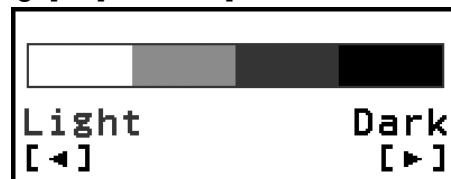

3. Use \odot and \odot to adjust display contrast.
4. After the setting is the way you want, press AC .

Important!

- If adjusting display contrast does not improve display readability, it probably means that battery power is low. Replace the battery.

Key Markings

Pressing the \uparrow key followed by a second key performs the alternate function of the second key. The alternate function is indicated by the text printed above the key, on the left.

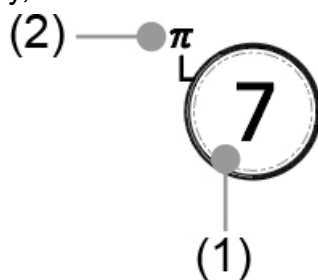

(1) Keycap function: 7

(2) Alternate function: \uparrow (7) (π)

Indicators

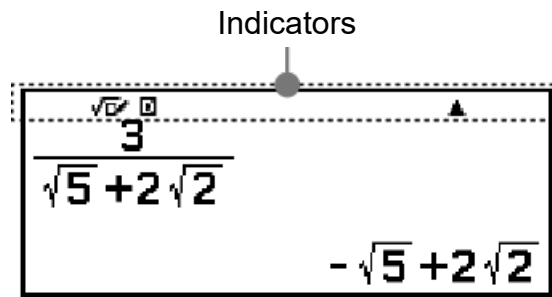

The table below describes indicators that appear at the top of the screen.

| This indicator: | Means this: |
|---|--|
| S | The keypad has been shifted by pressing the \uparrow key. The keypad will unshift and this indicator will disappear when you press a key. |
| $\sqrt{\square}$ | MathI/MathO or MathI/DecimalO is selected for Input/Output on the SETTINGS menu. |
| D / R / G | Current setting of Angle Unit (D : Degree, R : Radian, or G : Gradian) on the SETTINGS menu. |
| FIX | A fixed number of decimal places is in effect. |
| SCI | A fixed number of significant digits is in effect. |
| <i>i/∠</i> | Current setting of Complex Result (<i>i</i> : $a+bi$ or \angle : $r\angle\theta$) on the SETTINGS menu. |
| \checkmark | Verify is enabled (by selecting "Verify ON" on the TOOLS menu). |
| \blacktriangle / \blacktriangledown | There is previous (\blacktriangle) or following (\blacktriangledown) calculation history for the currently displayed calculation result. |

Using Menus

Many of the operations of your calculator are performed using menu screens. The example below shows operations starting from the menu screen that appears when you press \oplus .

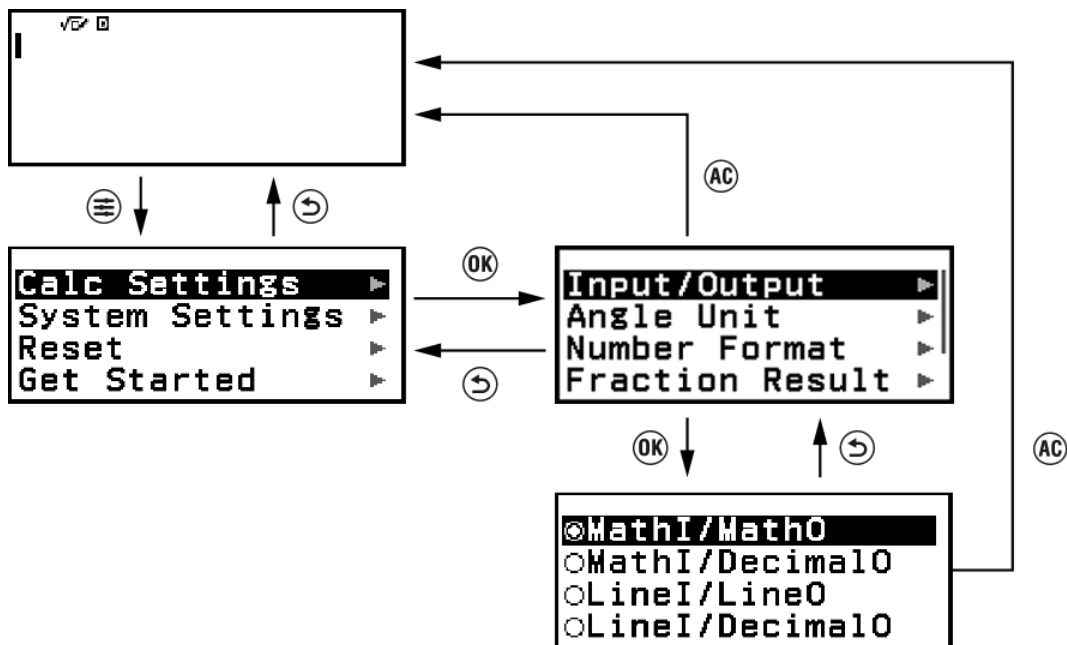

Selecting a Menu Item

To select a menu item, use the cursor keys (\uparrow , \downarrow , \leftarrow , \rightarrow) to highlight it and then press OK . Note that \leftarrow and \rightarrow are used only when there are multiple menu item columns.

Navigating Between Menu Hierarchies

The "▶" indicator to the right of a menu item means that there are lower hierarchy levels under that item. Selecting the menu item and pressing OK or \rightarrow navigates the next lower level of the hierarchy. To return to the next upper level of the hierarchy, press \leftarrow .

Note

- If you are in a lower level of the hierarchy of a one-column menu, you can press \leftarrow in addition to \leftarrow to return to the next higher level.

Selecting a Menu Item with a Radio Button (\circ/\bullet)

When the display shows a list of multiple options, each option will have a radio button (\circ or \bullet) to its left. \bullet indicates the currently selected option.

To configure the setting of a radio button menu item

1. Highlight the applicable menu item and then press OK .
 - What happens next depends on the type of menu item you selected.
 - If there are no more settings to configure for the menu item you selected, the radio button next to it will change to \bullet .

- The menu item you selected has more settings to configure, a screen for selecting the menu item setting will appear. In this case, proceed to step 2.
2. On the setting screen, highlight the setting you want and then press **OK**.
- This returns to the menu item screen in step 1, with the radio button next to the menu item you previously selected changed to **●**.

Scrolling Between Screens

A scroll bar will appear along the right side of the display when there are so many menu items that they do not fit on one screen.

- Use **▲** and **▼** to scroll between screens.
- Use **▲** and **▼** to scroll line-by-line.

To close the menu and return to the screen displayed before the menu

Press **AC**.

Note

- You can close a menu displayed by pressing **≡**, **2-3D**, **f(x)**, **□**, **000**, or **FORMA** by pressing **AC**. If the displayed menu is one that appears immediately after launching a particular calculator app or if it is an app-specific menu, you cannot close it by pressing **AC**. In that case, you must press **↶** to close the menu.

Calculator Apps and Menus

Calculator Apps

Selecting a Calculator App



Select a calculator app that is suitable for the type of calculation you want to perform.



1. Press \odot to display the HOME screen.
 - For information about each calculator app, see the ["Installed Calculator App List" \(page 16\)](#).

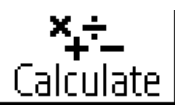

2. Use the cursor keys (\uparrow , \downarrow , \leftarrow , \rightarrow) to select the calculator app icon you want.
3. Press \odot to display the initial screen of the calculator app whose icon you selected.

Installed Calculator App List

| Icon | Description |
|---|---|
|  Calculate (Calculate)* | General calculations |
|  Statistics (Statistics) | Statistical and regression calculations |
|  Distribution (Distribution) | Distribution calculations |

| | |
|---|--|
|  Table (Table)* | Generates a number table based on one or two functions |
|  Complex (Complex)* | Complex number calculations |
|  Vector (Vector) | Vector calculations |

Note

- Verify, which is a function that determines the truth of an input equation or solution, is available with the calculator apps marked with an asterisk (*) in the above table. For information about Verify, see ["Using Verify" \(page 59\)](#).

Using the SETTINGS Menu

To display the SETTINGS menu, press  while using a calculator app. The SETTINGS menu includes the menu items below.



| | |
|------------------------|---|
| Calc Settings | Includes menu items for configuring calculation settings, such as the display format for calculation results. |
| System Settings | Includes menu items for configuring calculator operation settings, such as contrast adjustment. |
| Reset | Includes menu items for performing various types of reset operations. |

| | |
|-------------|--|
| Get Started | Displays the Get Started screen. For more information, see " Calculator "Get Started" Screen " (page 7). |
|-------------|--|

Note

- Pressing ☰ while the HOME screen is displayed will display the Get Started screen instead of the SETTINGS menu.
- Depending on the screen displayed by the calculator app, pressing ☰ may not display the SETTINGS menu.

Changing Calculator Settings

1. Press ⬆ , select a calculator app icon, and then press OK .
2. Press ☰ to display the SETTINGS menu.



3. Use ⬆ and ⬆ to select Calc Settings or System Settings, and then press OK .

- This displays a list of setting items included on the selected menu. The screen here shows an example of what appears when [Calc Settings] is selected.

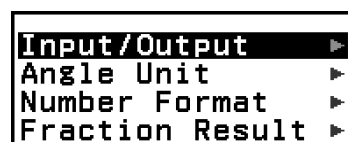

- See "[Items and Available Setting Options](#)" (page 19) for the setting items included for [Calc Settings] and [System Settings].
4. Use ⬆ and ⬆ to highlight the item whose setting you want to change, and then press OK .

- This displays a list of setting options for the item you selected. The screen here shows an example of what appears when [Input/Output] is selected.

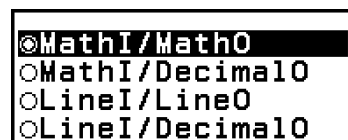

5. Use ⬆ and ⬆ to highlight the option you want, and then press OK .
6. After the setting is the way you want, press AC .

Items and Available Setting Options

"◆" indicates the initial default setting.

Calc Settings > Input/Output

Specifies the format to be used by the calculator for expression input and calculation result output.

| | |
|----------------|--|
| MathI/MathO◆ | Input: Natural Textbook; Output: Format that includes a fraction, $\sqrt{\quad}$, and/or π^{*1} |
| MathI/DecimalO | Input: Natural Textbook; Output: Converted to decimal value |
| LineI/LineO | Input: Linear ^{*2} ; Output: Decimal or fraction |
| LineI/DecimalO | Input: Linear ^{*2} ; Output: Converted to decimal value |

*1 Decimal output is applied when these formats cannot be output for some reason.

*2 All calculations, including fractions and functions are input in a single line. Same output format as that for models without Natural Textbook Display (S-V.P.A.M. models, etc.)

Input/output format display examples:

MathI/MathO
(initial default setting)

| | |
|-----------------|-----------------|
| $\frac{1}{200}$ | $\frac{1}{200}$ |
|-----------------|-----------------|

MathI/DecimalO
(Number Format: Norm 1)

| | |
|-----------------|--------------------|
| $\frac{1}{200}$ | 5×10^{-3} |
|-----------------|--------------------|

(Number Format: Norm 2)

| | |
|-----------------|-------|
| $\frac{1}{200}$ | 0.005 |
|-----------------|-------|

LineI/LineO

| | |
|-------|-------|
| 1┘200 | 1┘200 |
|-------|-------|

Line/DecimalO
(Number Format: Norm 2)



Calc Settings > Angle Unit

Degree \blacklozenge ; Radian; Gradian

Specifies degree, radian or gradian as the angle unit for value input and calculation result display.

Calc Settings > Number Format

Specifies the number of digits for display of a calculation result.

Fix: The value you specify (from 0 to 9) controls the number of decimal places for displayed calculation results. Calculation results are rounded off to the specified digit before being displayed.

Example: $1 \div 6$

(Fix 3)

$1 \div 6 \uparrow \text{EXE} (\approx)^*$

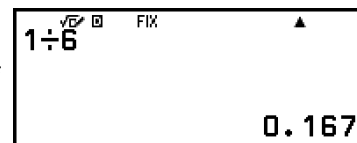

Sci: The value you specify (from 1 to 10) controls the number of significant digits for displayed calculation results. Calculation results are rounded off to the specified digit before being displayed.

Example: $1 \div 6$

(Sci 3)

$1 \div 6 \uparrow \text{EXE} (\approx)^*$

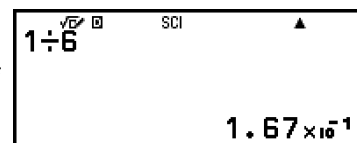

Norm: Displays calculation results in exponential format when they fall within the ranges below.

Norm 1: $10^{-2} > |x|$, $|x| \geq 10^{10}$, Norm 2 \blacklozenge : $10^{-9} > |x|$, $|x| \geq 10^{10}$

Example: $1 \div 200$

(Norm 1)

$1 \div 200 \uparrow \text{EXE} (\approx)^*$

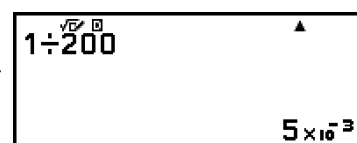

(Norm 2)

$1 \div 200 \uparrow \text{EXE} (\approx)^*$

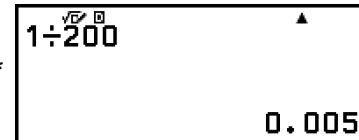

* Pressing $\uparrow \text{EXE} (\approx)$ instead of EXE after inputting a calculation will display the calculation result in decimal form.

Calc Settings > Fraction Result

Mixed Fraction; Improper Fraction[◆]

Specifies either mixed fraction or improper fraction for display of fractions in calculation results.

Calc Settings > Complex Result

$a+bi$ [◆]; $r\angle\theta$

Specifies either rectangular coordinates or polar coordinates for Complex app calculation results.

Note

- An i indicator is displayed at the top of the screen while $a+bi$ is selected for the Complex Result setting. \angle is displayed while $r\angle\theta$ is selected.

Calc Settings > Decimal Mark

Dot[◆]; Comma

Specifies whether to display a dot or a comma for the calculation result decimal mark. A dot is always displayed during input. When dot is selected as the decimal mark, the separator for multiple results is a comma (,). When comma is selected, the separator is a semicolon (;).

Calc Settings > Digit Separator

On[◆]; Off

Specifies whether or not a separator character should be used in calculation results.

System Settings > Contrast

See ["Adjusting Display Contrast" \(page 12\)](#).

System Settings > Auto Power Off

10 Min. ♦; 60 Min.

Specify the amount of time until Auto Power Off is triggered.

System Settings > MultiLine Font

Normal Font ♦; Small Font

Specifies the display font size when LineI/LineO or LineI/DecimalO is selected for Input/Output. Up to four lines can be displayed while Normal Font is selected, and up to six lines can be displayed with Small Font.

System Settings > QR Code

Specifies the version of the QR Code displayed when   (QR) is pressed.

Version 3: Indicates QR Code Version 3.

Version 11 ♦: Indicates QR Code Version 11.

Reset > Settings & Data

See ["To initialize calculator settings" \(page 22\)](#).

Reset > Variable Memory

See ["Clearing the Contents of All Memories" \(page 37\)](#).

Reset > Initialize All

See ["Initializing the Calculator" \(page 7\)](#).

Get Started

See ["Calculator "Get Started" Screen" \(page 7\)](#).

To initialize calculator settings

Important!

- The procedure below initializes all calculator settings, except for Contrast and Auto Power Off. Also clears all data except for variable memory and Ans and PreAns data.

1. Press \odot , select a calculator app icon, and then press OK .
2. Press \equiv , and then select [Reset] > [Settings & Data] > [Yes].
 - This displays the HOME screen.

Using the CATALOG Menu

Press \odot to display the CATALOG menu. This menu shows categories of the commands, functions, and symbols in accordance with the calculator app you are currently using and the current status (displayed screen or current settings) of the app.

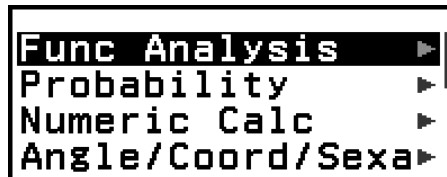

Example: CATALOG menu of the Calculate app

Note

- For information about how to input commands, functions, and symbols from the CATALOG menu, see ["Advanced Calculations" \(page 46\)](#).
- For information about the commands, functions, and symbols specific to each calculator app, refer to the calculator app descriptions in ["Using Calculator Apps" \(page 65\)](#).

Using the TOOLS Menu

The TOOLS menu that appears when you press ooo includes menu items for performing functions specific to each calculator app and for configuring settings.

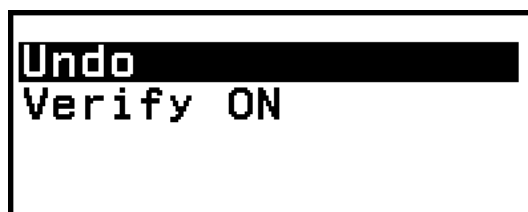

Example: TOOLS menu for the Calculate app

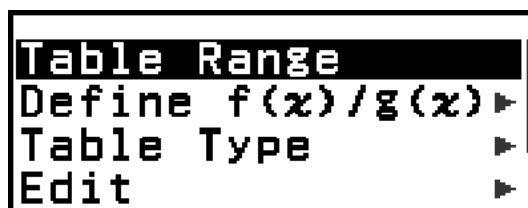

Examples: TOOLS menu for the Table app

Note

- The menu items below are common to multiple calculator apps.
 - Undo (See ["Undo Operations" \(page 27\)](#).)
 - Verify ON, Verify OFF (See ["Using Verify" \(page 59\)](#).)

Inputting Expressions and Values

Basic Input Rules

When you press EXE the priority sequence of the input calculation will be evaluated automatically and the result will appear on the display.

$$4 \times \sin 30 \times (30 + 10 \times 3) = 120$$

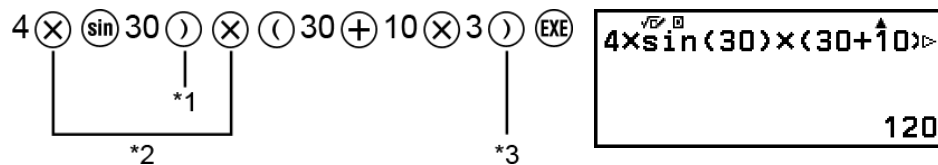

- *1 Input of the closing parenthesis is required for sin and other functions that include parentheses.
- *2 These multiplication symbols (x) can be omitted.
- *3 The closing parenthesis immediately before the EXE operation can be omitted.

Moving the Cursor to the Beginning or End of an Input Expression

While inputting an expression, you can press HOME to make the cursor jump to the beginning of the expression or END to jump to the end of the expression.

Input Expression and Calculation Result "More" Indicator (▶, ▶-)

If you see a pointer (▶ or ▶-) symbol on the right side of either an input expression line or calculation result line, it means the displayed line continues to the right. Use LEFT and RIGHT to scroll the line left and right.

- When you see ▶ at the right end of a calculation result line, you can jump to the end of the result by pressing END . To jump to the beginning of a calculation result line, press HOME .
- Note that if you want to scroll the input expression while both the ▶ and ▶- indicators are displayed, you will need to press ON or AC first and then use LEFT and RIGHT to scroll.

Pol(1.414213562, 45)
r=2, theta=0.785398163

Parentheses Auto Complete

If you execute a calculation that includes both division and multiplication operations in which a multiplication sign has been omitted, parentheses will be inserted automatically as shown in the examples below.

- When a multiplication sign is omitted immediately before an open parenthesis or after a closing parenthesis.

Example: $6 \div 2(1 + 2) \rightarrow 6 \div (2(1 + 2))$

- When a multiplication sign is omitted immediately before a variable, a constant, etc.

Example: $6 \div 2\pi \rightarrow 6 \div (2\pi)$

Input Limit Indication

The cursor will change shape to ■ when there are 10 bytes or less of allowed input remaining. If this happens, end calculation input and then press EXE .

Inputting an Expression Using Natural Textbook Format (MathI/MathO or MathI/DecimalO Only)

Expressions that include fractions and/or special functions such as $\sqrt{\quad}$ can be input in natural textbook format by using templates that appear when certain keys are pressed, or when you input certain functions from the CATALOG menu.

Example: $3\frac{1}{2} + 5\frac{3}{2}$

1. Press ↑ □ □ □ .

- This inputs a mixed fraction template.

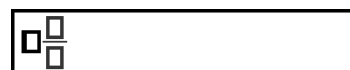

2. Input values into the integer, numerator, and denominator areas of the template.

Basic Calculations

Arithmetic Calculations

Use the \oplus , \ominus , \otimes , and \odiv keys to perform arithmetic calculations.

Example: $7 \times 8 - 4 \times 5 = 36$

$7 \otimes 8 \ominus 4 \otimes 5 \text{ EXE}$

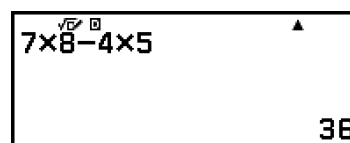

Fraction Calculations

Note that the input method for fractions depends on the current Input/Output setting on the SETTINGS menu.

To input $\frac{7}{3}$ (improper fraction)

(Input/Output: MathI/MathO or MathI/DecimalO)

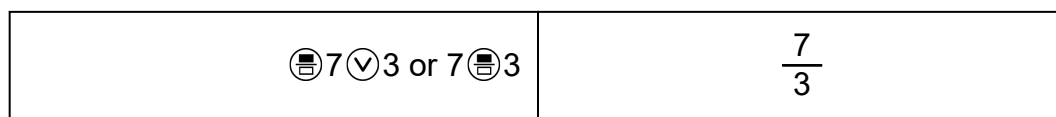

(Input/Output: LineI/LineO or LineI/DecimalO)

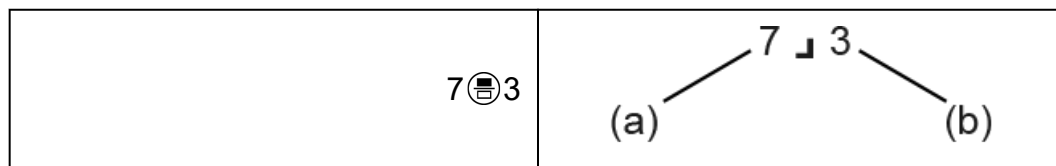

(a) Numerator, (b) Denominator

To input $2 \frac{1}{3}$ (mixed fraction)

(Input/Output: MathI/MathO or MathI/DecimalO)

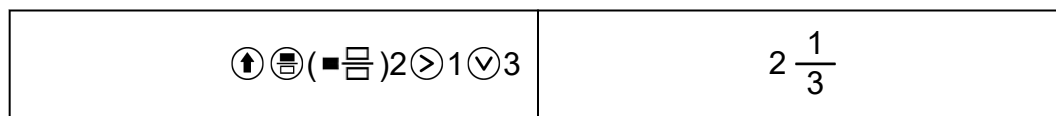

(Input/Output: LineI/LineO or LineI/DecimalO)

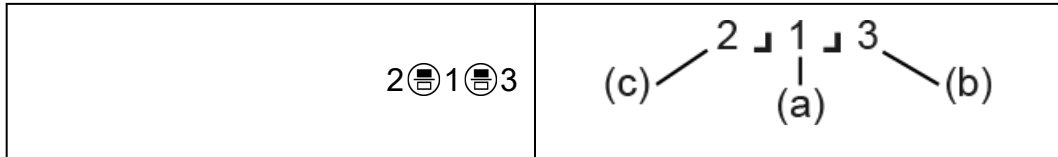

(a) Numerator, (b) Denominator, (c) Integer Part

Example: $\frac{2}{3} + 1\frac{1}{2} = \frac{13}{6}$

(Input/Output: MathI/MathO)

$2 \frac{1}{3} \text{ (Frac)} \text{ (>) } + \text{ (Frac)} \text{ (1) } \frac{1}{2} \text{ (Frac)} \text{ (EXE)}$



(Input/Output: LineI/LineO)

$2 \frac{1}{3} \text{ (Frac)} \text{ (+) } 1 \frac{1}{2} \text{ (Frac)} \text{ (EXE)}$

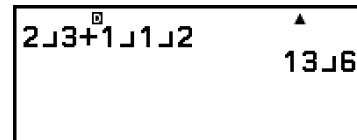

Note

- Fractions in calculation results are displayed after being reduced to their lowest terms.

To convert a calculation result format to improper fraction or mixed fraction, press (FORMAT) . For more information, see ["Improper Fraction and Mixed Fraction Conversion" \(page 43\)](#).

Fraction Format Calculation Results

A calculation result whose total number of mixed fraction number of digits (including integer, numerator, denominator, and separator symbol $\frac{_}{_}$) is greater than 10 cannot be displayed using fraction format. In this case, the calculation result is displayed as a decimal value.

Example 1: $1 \frac{1}{1} \frac{123456}{123456} = 123457 \frac{1}{123456}$

(Input/Output: LineI/LineO)

$1 \frac{1}{1} \text{ (Frac)} \frac{123456}{123456} \text{ (EXE)}$

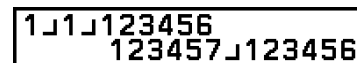

Since the total number of digits of the value $1 \frac{1}{1} \frac{123456}{123456}$ is 10, the result is displayed as a fraction value.

Example 2: $1 \frac{1}{1} \frac{1234567}{1234567} (= 1234568 \frac{1}{1234567}) = 1.00000081$

(Input/Output: LineI/LineO)

1 $\frac{\square}{\square}$ 1 $\frac{\square}{\square}$ 1234567 $\frac{\square}{\square}$ $\frac{\square}{\square}$ 1.00000081

Since the total number of digits of the value $1 \frac{\square}{\square} 1 \frac{\square}{\square} 1234567$ is 11, the result is displayed as a decimal value.

Note

- Mixing fractions and decimal values in a calculation while something other than MathI/MathO is selected will cause the result to be displayed as a decimal value.

Powers, Power Roots, and Reciprocals

Use the keys below to input power functions, power root functions, and reciprocal function.

Power functions: $\frac{\square}{\square}$ (square), $\frac{\square}{\square}$ (n^{th} power)

Power root functions: $\sqrt{\square}$ (square root), $\sqrt[n]{\square}$ (n^{th} root)

Reciprocal function: $\frac{\square}{\square}$ (\square^{-1})

Example 1: $(5^2)^3 = 15625$

(5 $\frac{\square}{\square}$) $\frac{\square}{\square}$ 3 $\frac{\square}{\square}$

$\sqrt{\square}$ $\frac{\square}{\square}$
 $(5^2)^3$
15 625

Example 2: $(1 + 1)^{2+2} = 16$

(1 + 1) $\frac{\square}{\square}$ 2 + 2 $\frac{\square}{\square}$

$\sqrt{\square}$ $\frac{\square}{\square}$
 $(1+1)^{2+2}$
16

Example 3: $\sqrt{2} \times 3 = 3\sqrt{2} = 4.242640687\dots$

(Input/Output: MathI/MathO)

$\sqrt{\square}$ 2 > \times 3 $\frac{\square}{\square}$

$\sqrt{\square}$ $\frac{\square}{\square}$
 $\sqrt{2} \times 3$
 $3\sqrt{2}$

(Input/Output: LineI/LineO)

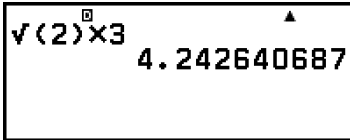
$$\sqrt{\square} 2 \text{) } \times 3 \text{ EXE}$$

Example 4: ${}^5\sqrt{32} = 2$

(Input/Output: MathI/MathO)

$$\uparrow \sqrt{\square} (\sqrt{\square}) 5 > 32 \text{ EXE}$$

(Input/Output: LineI/LineO)

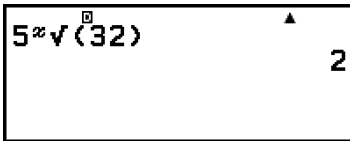
$$5 \uparrow \sqrt{\square} (\sqrt{\square}) 32 \text{) EXE}$$

Example 5: $10^{-1} = \frac{1}{10}$

(Input/Output: MathI/MathO)

$$10 \uparrow \square (\square^{-1}) \text{ EXE}$$

$\times 10^{\square}$ Key (Power of 10)

Pressing the $\times 10^{\square}$ key is the same as pressing $\times \text{ () } 0 \text{ () } \square$. Both operations input " $\times 10^{\square}$ " (MathI/MathO or MathI/DecimalO) or " $\times 10^{\square}$ " (LineI/LineO or LineI/DecimalO).

Example: $1.23 \times 10^3 = 1230$

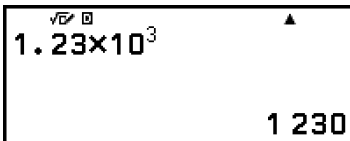
$$1 \text{ () } 23 \times 10^{\square} 3 \text{ EXE}$$

$\sqrt{\square}$ Form Calculation Range

The allowable display ranges of the $\sqrt{\square}$ form calculation result are shown below.

$$\pm a\sqrt{b}, \pm d \pm a\sqrt{b}, \pm \frac{a\sqrt{b}}{c} \pm \frac{d\sqrt{e}}{f}$$

$$1 \leq a < 100, 1 < b < 1000, 1 \leq c < 100$$

$$0 \leq d < 100, 0 \leq e < 1000, 1 \leq f < 100$$

Example:

- $10\sqrt{2} + 15 \times 3\sqrt{3} = 45\sqrt{3} + 10\sqrt{2} \dots$ Displayed in $\sqrt{\quad}$ form
- $99\sqrt{999} (= 297\sqrt{111}) = 3129.089165 \dots$ Displayed as a decimal value

Pi, Natural Logarithm Base e

Pi

Input π by pressing \uparrow $\textcircled{7}$ (π).

π is displayed as 3.141592654, but $\pi = 3.1415926535897932384626$ is used for internal calculations.

Natural Logarithm Base e

Input e by pressing \uparrow $\textcircled{8}$ (e).

Natural Logarithm Base e is displayed as 2.718281828, but $e = 2.7182818284590452353602$ is used for internal calculations.

Calculation History and Replay

Calculation History

An \blacktriangle and/or \blacktriangledown at the top of the screen indicates more calculation history content above and/or below. You can scroll through calculation history contents using $\textcircled{\wedge}$ and $\textcircled{\vee}$.

Apps that support calculation history:

Calculate, Complex

Example

$2 + 2 = 4$

$2 \textcircled{+} 2 \textcircled{\text{EXE}}$



$3 + 3 = 6$

$3 \textcircled{+} 3 \textcircled{\text{EXE}}$



$\textcircled{\wedge}$
(Scrolls back.)



Note

- Calculation history data is all cleared whenever you press \uparrow or \downarrow , when you change the Input/Output setting, or whenever you perform a Reset operation ("Settings & Data" or "Initialize All").

Replay

While a calculation result is on the display, you can press \leftarrow , \rightarrow or \rightarrow to edit the expression you used for the previous calculation.

Example

$$4 \times 3 + 2 = 14$$

$$4 \times 3 + 2 \text{ EXE}$$

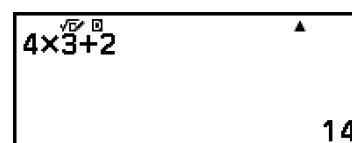

$$4 \times 3 - 7 = 5$$

$$\text{(Continuing)} \quad \leftarrow \text{AC} \text{AC} - 7 \text{ EXE}$$

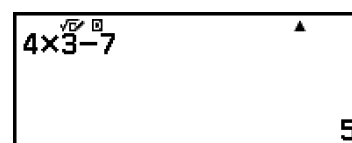

Note

- If \blacktriangleleft (left) or \blacktriangleright (right) is displayed on either end or both ends of a calculation result line, you can use \leftarrow and \rightarrow to scroll the line left and right. If this happens, press \rightarrow or AC first, and then use \leftarrow and \rightarrow to edit the expression.

Using Memory Functions

Answer Memory (Ans) / Previous Answer Memory (PreAns)

The last calculation result obtained is stored in Ans (answer) memory. The calculation result obtained prior to the last one is stored in PreAns (previous answer) memory. Displaying the result of a new calculation will move current Ans memory contents to PreAns memory and store the new calculation results in Ans memory.

Note

- PreAns memory can be used only in the Calculate app.

- PreAns memory contents are cleared whenever you switch to another app besides the Calculate app.

Using Ans Memory to Perform a Series of Calculations

Example: To divide the result of 3×4 by 30

$$3 \otimes 4 \text{ EXE} \quad \boxed{12}$$

(Continuing) $\otimes 30 \text{ EXE}$

$$\text{Ans} \div 30 \quad \blacktriangle$$

$$\frac{2}{5}$$

Inputting Ans Memory Contents into an Expression

Example: To perform the calculations shown below:

$$123 + 456 = 579 \quad 789 - 579 = 210$$

$$123 \oplus 456 \text{ EXE} \quad \boxed{579}$$

(Continuing) $789 \ominus \text{Ans} \text{ EXE}$

$$789 - \text{Ans} \quad \blacktriangle$$

$$210$$

Using PreAns Memory

Example: For $T_{k+2} = T_{k+1} + T_k$ (Fibonacci sequence), determine the sequence from T_1 to T_5 . Note however, that $T_1 = 1$ and $T_2 = 1$.

$$T_1 = 1$$

$$1 \text{ EXE} \quad \boxed{1}$$

(Ans = $T_1 = 1$)

$$T_2 = 1$$

$$1 \text{ EXE} \quad \boxed{1}$$

(Ans = $T_2 = 1$, PreAns = $T_1 = 1$)

$$T_3 = T_2 + T_1 = 1 + 1$$

$$\text{Ans} \oplus \uparrow \text{Ans} \text{ (PreAns) EXE}$$

$$\text{Ans} + \text{PreAns} \quad \blacktriangle$$

$$2$$

(Ans = $T_3 = 2$, PreAns = $T_2 = 1$)

$$T_4 = T_3 + T_2 = 2 + 1$$



(Ans = $T_4 = 3$, PreAns = $T_3 = 2$)

$$T_5 = T_4 + T_3 = 3 + 2$$



Result: The sequence is {1, 1, 2, 3, 5}.

Variables (A, B, C, D, E, F, x, y, z)

You can store values to variables and use the variables in calculations.

Variable List Screen

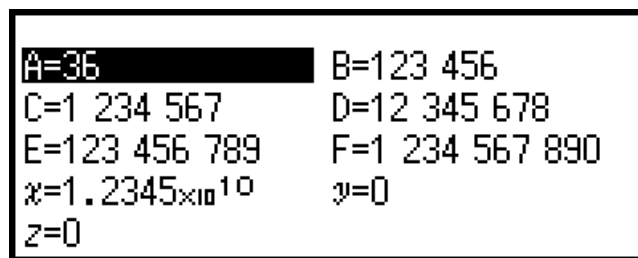

Pressing $\left(\frac{\text{Var}}{\text{List}}$) displays a screen that shows the values currently stored to variables A, B, C, D, E, F, x, y, and z. On this screen, values are always displayed using the "Norm 1" Number Format. To close the screen, press $\left(\frac{\text{Left Arrow}}$) or $\left(\frac{\text{AC}}$

Example 1: To store the result of $3 + 5$ to variable A

1. Execute the calculation.

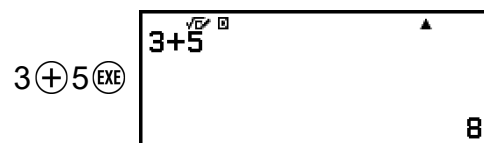

2. Press $\left(\frac{\text{Var}}{\text{List}}$) , and then select [A=] > [Store].

- This stores the result of $3 + 5$ (which is 8) to variable A.

3. Press $\left(\frac{\text{Var}}{\text{List}}$) .



Example 2: To change the contents of variable A to 1

1. Press $\left(\frac{\text{Var}}{\text{List}}$) , and then highlight [A=].



2. Press $\text{\textcircled{1}}$.

- This displays the editing screen with 1 entered.



A=1

3. Press $\text{\textcircled{EXE}}$.



A=1 B=0

Note

- In place of the operation in step 2 above, you can press $\text{\textcircled{OK}}$ and then select [Edit]. This displays the editing screen with nothing input. Input the value you want and then press $\text{\textcircled{EXE}}$.
- If a lock ($\text{\textcircled{L}}$) icon appears when you highlight a variable on the variable list screen, it means the highlighted variable cannot be edited.

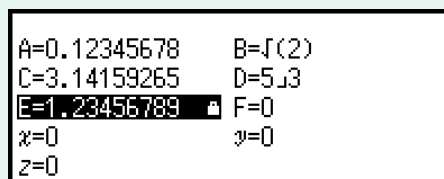

A=0.12345678 B=J(2)
C=3.14159265 D=5.3
E=1.23456789 $\text{\textcircled{L}}$ F=0
x=0 y=0
z=0

Example 3: To recall the contents of variable A
(Continuing from step 2 of Example 1)

1. Press $\text{\textcircled{2.3}}$, and then select [A=] > [Recall].

- This inputs "A".



A

2. Press $\text{\textcircled{EXE}}$.

- This recalls the value of variable A.



A $\text{\textcircled{L}}$ \blacktriangle
8

Example 4: To multiply the contents of variable A by 10
(Continuing from step 2 of Example 1)

$\text{\textcircled{\uparrow}} \text{\textcircled{4}} \text{\textcircled{(A)}} * \text{\textcircled{\times}} 10 \text{\textcircled{EXE}}$



A $\text{\textcircled{L}}$ \blacktriangle
A*10
80

* Input a variable as shown here: press $\text{\textcircled{\uparrow}}$ and then press the key that corresponds to the desired variable name. To input x as the variable name, you can press $\text{\textcircled{\uparrow}} \text{\textcircled{0}} (x)$ or $\text{\textcircled{\times}}$.

Clearing the Contents of All Memories

Ans memory and variable contents are retained even if you press AC , change the calculator app, or turn off the calculator.

PreAns memory contents are retained even if you press AC and turn off the calculator without exiting the Calculate app.

Perform the procedure below when you want to clear the contents of all memories.

1. Press HOME , select a calculator app icon, and then press OK .
2. Press MENU , and then select [Reset] > [Variable Memory] > [Yes].

Changing Calculation Result Format

Using the FORMAT Menu

You can use the FORMAT menu that appears when you press  to convert a displayed calculation result to various formats.

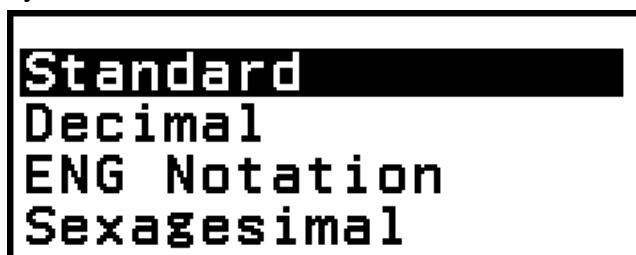

FORMAT Menu List

| This menu item: | Converts to this format: |
|-------------------|---|
| Standard | Standard (Includes fraction, π , $\sqrt{\quad}$ formats.) |
| Decimal | Decimal |
| Prime Factor | Prime factorization |
| Recurring Decimal | Recurring decimal |
| Rectangular Coord | Rectangular coordinates |
| Polar Coord | Polar coordinates |
| Improper Fraction | Improper fraction |
| Mixed Fraction | Mixed fraction |
| ENG Notation | Engineering notation ($a \times 10^n$ format, n = exponent divisible by 3) |
| Sexagesimal | Degree, minute, second (Sexagesimal) |

Note

- The menu items that appear when FORMAT is pressed depend on the currently displayed calculation result. Also, if a calculation result that cannot be converted is displayed, the menu will not appear when you press FORMAT .

Conversion Sample Operation

Example: $3 \div 2 = \frac{3}{2} = 1.5 = 1 \frac{1}{2}$

In this example, we will convert a calculation result displayed as an improper fraction to a decimal value and then to a mixed fraction. Finally, we will cancel the conversion and go back to the original calculation result. (Input/Output: MathI/MathO, Fraction Result: Improp Fraction)

1. Execute the calculation $3 \div 2$.

$3 \div 2 \text{ EXE}$



The calculator display shows the expression $3 \div 2$ in the top left corner. In the bottom right corner, the result is displayed as the improper fraction $\frac{3}{2}$. Above the expression, there are icons for \sqrt{x} , \square , and \blacktriangle .

2. To convert the calculation result to a decimal value, press FORMAT , select [Decimal], and then press EXE .



The calculator display shows the expression $3 \div 2$ in the top left corner. In the bottom right corner, the result is displayed as the decimal value 1.5. Above the expression, there are icons for \sqrt{x} , \square , and \blacktriangle .

3. To convert the calculation result to a mixed fraction, press FORMAT , select [Mixed Fraction], and then press EXE .



The calculator display shows the expression $3 \div 2$ in the top left corner. In the bottom right corner, the result is displayed as the mixed fraction $1 \frac{1}{2}$. Above the expression, there are icons for \sqrt{x} , \square , and \blacktriangle .

4. To cancel conversion, press EXE .
 - This displays the original calculation result from step 1.



The calculator display shows the expression $3 \div 2$ in the top left corner. In the bottom right corner, the result is displayed as the improper fraction $\frac{3}{2}$. Above the expression, there are icons for \sqrt{x} , \square , and \blacktriangle .

Standard and Decimal Conversion

Standard is a format that displays a calculation result in a form that includes a fraction, $\sqrt{\quad}$, or π when possible. Decimal is a format that displays the calculation result as a decimal value.

Example: To perform prime factorization on 1014

1014 

\sqrt{x} $\frac{D}{D}$ ▲
 1014
1 014

 – [Prime Factor]

\sqrt{x} $\frac{D}{D}$ ▲
 1014
2×3×13²

Note

- The types of values described below cannot be factored, even if they have 10 or fewer digits.
 - One of the prime factors of the value is 1,018,081 or greater.
 - Two or more of the prime factors of the value have more than three digits.
- The part that cannot be factored is enclosed in parentheses on the display.

Example: $2036162 = 2 \times (1018081)^*$

*1018081 = 1009²

2036162 

\sqrt{x} $\frac{D}{D}$ ▲
 2036162
2×(1 018 081)

 – [Prime Factor]

Recurring Decimal Conversion (Recurring Decimal Calculations)

Your calculator lets you convert a calculation result to recurring decimal format in the Calculate app when possible. It also makes it possible for you to input a recurring decimal value and perform a calculation.

Converting a Calculation Result to a Recurring Decimal Value

To convert a calculation result to a recurring decimal value, press , and then select [Recurring Decimal] from the FORMAT menu that appears. For the actual operation, see "[Recurring Decimal Calculation Example](#)" (page 42).

Inputting a Recurring Decimal

To input a recurring decimal value, use the CATALOG menu item shown below.

 – [Numeric Calc] > [Recurring Decimal]

For the actual operation, see "[Recurring Decimal Calculation Example](#)" (page 42).

Important!

- If the value starts with an integer part (like: 12.3123123...), do not include the integer part when inputting the period ($12.\dot{3}1\dot{2}$).
- Recurring decimal input is possible only when MathI/MathO or MathI/DecimalO is selected for Input/Output on the SETTINGS menu.

Recurring Decimal Calculation Example

To calculate $3.\dot{0}2\dot{1} + 0.\dot{3}1\dot{2}$ (Input/Output: MathI/MathO)

1. Use the following operation to input the calculation expression.

$$3 \text{ (.) } \text{ (.) } - [\text{Numeric Calc}] > \boxed{3.\dot{0}2\dot{1} +}$$

$$[\text{Recurring Decimal}] 021 \text{ (.) } \text{ (+)}$$

$$0 \text{ (.) } \text{ (.) } - [\text{Numeric Calc}] > \boxed{3.\dot{0}2\dot{1} + 0.\dot{3}1\dot{2} \quad \frac{10}{3}}$$

$$[\text{Recurring Decimal}] 312 \text{ (EXE)}$$

- This displays the calculation result as a fraction.

2. Press (FORMAT) , and then select [Recurring Decimal].

- This changes the result format to recurring decimal.

$$\boxed{3.\dot{0}2\dot{1} + 0.\dot{3}1\dot{2} \quad \frac{10}{3}}$$

$$3.\dot{3}$$

- To return the calculation result to a fraction, select (FORMAT) – [Standard].

Note

- Only a calculation result that satisfies the conditions below can be displayed as a recurring decimal.
 - The total number of digits used in the mixed fraction (including integer, numerator, denominator, and separator symbol) must be no more than 10.
 - The data size of the value when displayed as a recurring decimal must be no larger than 99 bytes, calculated as: [number of digits (1 byte each)] + [1 byte for the decimal point] + [3 bytes for recurring decimal management code]. For example, the data size of $0.\dot{1}2\dot{3}$ would be 4 bytes for digits, 1 byte for the decimal point, and 3 bytes for recurring decimal management code, for a total of 8 bytes.

Rectangular and Polar Coordinate Conversion

You can convert a complex number calculation result to rectangular coordinates (FORMAT – [Rectangular Coord]) or polar coordinates (FORMAT – [Polar Coord]). This conversion operation can be performed while a Complex app calculation result is displayed.

For an actual sample conversion operation, see the section below.

["Converting a Complex Number Calculation Result to Rectangular or Polar Coordinates" \(page 94\)](#)

Improper Fraction and Mixed Fraction Conversion

You can convert the currently displayed fraction or decimal value (decimal value that is convertible to a fraction by this calculator) calculation result to a mixed fraction or an improper fraction.

Example 1: $\frac{13}{4} = 3 \frac{1}{4}$

(Input/Output: MathI/MathO, Fraction Result: Improp Fraction)

| | |
|-------------------------------------|------------------------------------|
| $13 \text{ (Frac)} 4 \text{ (EXE)}$ | <input type="text" value="13/4"/> |
| FORMAT – [Mixed Fraction] | <input type="text" value="3 1/4"/> |
| FORMAT – [Improper Fraction] | <input type="text" value="13/4"/> |

Example 2: $3.25 = \frac{13}{4} = 3 \frac{1}{4}$ (Input/Output: LineI/LineO)

| | |
|----------------------------------|------------------------------------|
| $3 \text{ (.)} 25 \text{ (EXE)}$ | <input type="text" value="3.25"/> |
| FORMAT – [Improper Fraction] | <input type="text" value="13/4"/> |
| FORMAT – [Mixed Fraction] | <input type="text" value="3 1/4"/> |

Engineering Notation

You can convert the exponent part of a displayed calculation result value to a power of ten that is a multiple of 3, and displays the result.

Example: Transform the value 1234 to engineering notation, shifting the decimal mark to the right, and then to the left.

1. Input 1234, and then press EXE .



2. Perform the operation below to enter the ENG Conversion Mode.

FORMAT – [ENG Notation]

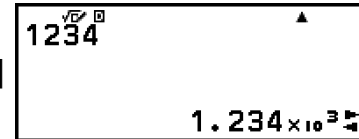

- Entering the ENG Conversion Mode converts the calculation result to engineering notation and causes ENG to appear to its right.
- In the ENG Conversion Mode, you can use LEFT and RIGHT to shift the decimal point of the mantissa.

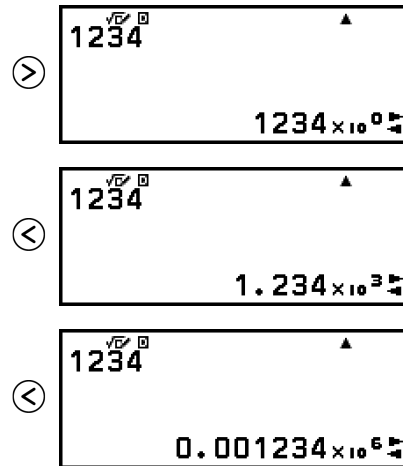

3. To exit the ENG Conversion Mode, press EXIT .

- This exits the ENG Conversion Mode and causes ENG to disappear from the display.

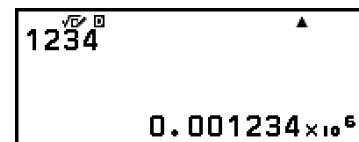

- You can also exit the ENG Conversion Mode by pressing OK or AC .

Note

- Normal calculations are not possible while in the ENG Conversion Mode. To start a new calculation, exit the ENG Conversion Mode.

Sexagesimal Conversion (Degree, Minute, Second Calculations)

You can convert a decimal value calculation result to a sexagesimal value.

Converting a Decimal Value Calculation Result to a Sexagesimal Value

Example: $1.25 = 1^{\circ}15'0''$

1 . 25 EXE

| | |
|------|--------|
| 1.25 | 5 4 |
|------|--------|

FORMAT – [Sexagesimal]

| | |
|------|-----------|
| 1.25 | 1° 15' 0" |
|------|-----------|

Inputting and Calculating with a Sexagesimal Value

In addition to converting a displayed value to a sexagesimal value, you can also input sexagesimal values and use them in calculations.

The syntax below is for inputting a sexagesimal value:

{degrees} \uparrow \oplus (°) {minutes} \uparrow \oplus (°) {seconds} \uparrow \oplus (°)

Note that you must always input something for the degrees and minutes, even if they are zero.

Example: To perform the calculation $2^{\circ}20'30'' + 9'30''$. Next, convert the calculation result to a decimal value.

2 \uparrow \oplus (°) 20 \uparrow \oplus (°) 30 \uparrow \oplus (°) \oplus
 0 \uparrow \oplus (°) 9 \uparrow \oplus (°) 30 \uparrow \oplus (°) EXE

| | |
|------------------------|-----------|
| 2° 20' 30" + 0° 9' 30" | 2° 30' 0" |
|------------------------|-----------|

(Convert to a decimal value.)

FORMAT – [Decimal]

| | |
|------------------------|-----|
| 2° 20' 30" + 0° 9' 30" | 2.5 |
|------------------------|-----|

(Return to sexagesimal display.)

FORMAT – [Sexagesimal]

| | |
|------------------------|-----------|
| 2° 20' 30" + 0° 9' 30" | 2° 30' 0" |
|------------------------|-----------|

Advanced Calculations

This section describes commands, functions, and symbols that are common to all of the calculator apps. The order used here to present commands, functions, and symbols is the same order in which they are displayed on the CATALOG menu that appears when you press $\text{\textcircled{C}}$.

Note

- There are also calculator app-specific CATALOG menu items, which are not shown here. See the chapter for each calculator app for more information about app-specific menu items.
- Depending on the calculator app you are using and the screen displayed by the calculator app, you may not be able to input some commands, functions, or symbols. Commands, functions, and symbols that cannot be input do not appear on the CATALOG menu.

Function Analysis

This section explains commands and functions that you can input after performing the operation: $\text{\textcircled{C}}$ – [Func Analysis].

Summation(Σ)

With $\Sigma($, you can obtain the sum of an input $f(x)$ expression for a specific range.

Note

- This function can be used with any of the following calculator apps: Calculate, Statistics, Distribution, Table, Vector.

Input Syntax

The input syntax depends on the Input/Output setting on the SETTINGS menu, as shown in the table below.

| Input/Output setting | Input Syntax |
|-------------------------------|-----------------------|
| MathI/MathO or MathI/DecimalO | $\sum_{x=a}^b (f(x))$ |

| | |
|-------------------------------|----------------------|
| LineI/LineO or LineI/DecimalO | $\sum(f(x), a, b)^*$ |
|-------------------------------|----------------------|

* a and b are integers that can be specified within the range of $-1 \times 10^{10} < a \leq b < 1 \times 10^{10}$.

Σ Calculation Example

$$\sum_{x=1}^5 (x + 1) = 20$$

(Input/Output: MathI/MathO)

$\text{[Func Analysis]} > \text{[Summation}(\Sigma)\text{]}$
 $\text{[x]} \text{[+]} \text{[1]} \text{[v]} \text{[1]} \text{[^]} \text{[5]} \text{[EXE]}$

Calculator screen showing the summation of $(x+1)$ from $x=1$ to 5 , resulting in 20 .

(Input/Output: LineI/LineO)

$\text{[Func Analysis]} > \text{[Summation}(\Sigma)\text{]}$
 $\text{[x]} \text{[+]} \text{[1]} \text{[f]} \text{[)]} \text{[,]} \text{[1]} \text{[f]} \text{[)]} \text{[,]} \text{[5]} \text{[)]} \text{[EXE]}$

Calculator screen showing the summation of $(x+1, 1, 5)$, resulting in 20 .

Π Product(Π)

With $\Pi()$, you can obtain the product of an input $f(x)$ expression for a specific range.

Note

- This function can be used with any of the following calculator apps: Calculate, Statistics, Distribution, Table, Vector.

Input Syntax

The input syntax depends on the Input/Output setting on the SETTINGS menu, as shown in the table below.

| Input/Output setting | Input Syntax |
|-------------------------------|------------------------|
| MathI/MathO or MathI/DecimalO | $\prod_{x=a}^b (f(x))$ |
| LineI/LineO or LineI/DecimalO | $\Pi(f(x), a, b)^*$ |

* a and b are integers that can be specified within the range of $a < 1 \times 10^{10}$, $b < 1 \times 10^{10}$, $a \leq b$.

∏ Calculation Example

$$\prod_{x=1}^5 (x + 1) = 720$$

(Input/Output: MathI/MathO)

☒ – [Func Analysis] > [Product(∏)]
 (x) (+) 1 (v) 1 (^) 5 (EXE)

∏_{x=1}⁵ (x+1) = 720

(Input/Output: LineI/LineO)

☒ – [Func Analysis] > [Product(∏)]
 (x) (+) 1 (↑) (,) 1 (↑) (,) 5 (,) (EXE)

∏(x+1, 1, 5) = 720

Logarithm(logab), Logarithm(log)

Use (↑) (log) or ☒ – [Func Analysis] > [Logarithm(log)] to input \log_{ab} as $\log(a, b)$. Base 10 is the initial default setting if you do not input anything for a .

Example 1: $\log_{10}1000 = \log 1000 = 3$

(↑) (log) 1000 (,) (EXE)

log(1000) = 3

Example 2: $\log_216 = 4$

(↑) (log) 2 (↑) (,) 16 (,) (EXE)

log(2, 16) = 4

The (log=) key (or ☒ – [Func Analysis] > [Logarithm(logab)]) also can be used for input, but only while MathI/MathO or MathI/DecimalO is selected for Input/Output on the SETTINGS menu. In this case, you must input a value for the base.

Example 3: $\log_216 = 4$

(log=) 2 (>) 16 (EXE)

log₂(16) = 4

Natural Logarithm

Use \uparrow \log (ln) or \square – [Func Analysis] > [Natural Logarithm] to input "ln".

Example: $\ln 90 (= \log_e 90) = 4.49980967$

\uparrow \log (ln) 90 \rightarrow EXE

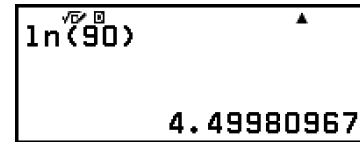

Calculator display showing the input $\ln(90)$ and the result 4.49980967.

Probability

This section explains commands and functions that you can input after performing the operation: \square – [Probability].

%

Inputting a value followed by % command causes the input value to become a percent.

Note

- You cannot input % with the Complex app.

Example 1: $150 \times 20\% = 30$

150×20
 \square – [Probability] > [%]
EXE

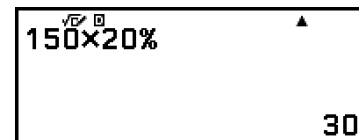

Calculator display showing the input $150 \times 20\%$ and the result 30.

Example 2: Calculate what percentage of 880 is 660. (75%)

$660 \div 880$
 \square – [Probability] > [%]
EXE

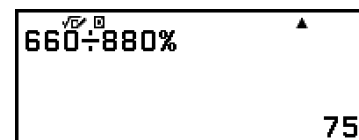

Calculator display showing the input $660 \div 880\%$ and the result 75.

Example 3: Discount 3500 by 25%. (2625)

$3500 - 3500 \times 25$
 \square – [Probability] > [%]
EXE

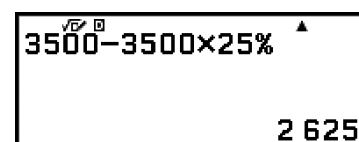

Calculator display showing the input $3500 - 3500 \times 25\%$ and the result 2 625.

Factorial(!)

This function obtains the factorials of a value that is zero or a positive integer.

Example: $(5 + 3)! = 40320$

$\text{Ⓜ} - [\text{Probability}] > [\text{Factorial}(!)]$

$\text{Ⓜ} \text{ (5+3) !}$

EXE



Permutation(P), Combination(C)

Permutation (nPr) and combination (nCr) functions.

Example: To determine the number of permutations and combinations possible when selecting four people from a group of 10

Permutations:

$\text{Ⓜ} - [\text{Probability}] > [\text{Permutation(P)}]$

$\text{Ⓜ} \text{ 10P4}$

EXE



Combinations:

$\text{Ⓜ} - [\text{Probability}] > [\text{Combination(C)}]$

$\text{Ⓜ} \text{ 10C4}$

EXE



Random Number

This function generates a pseudo random number in the range of 0.000 to 0.999. The result is displayed as a fraction when MathI/MathO is selected for Input/Output on the SETTINGS menu.

Example: To obtain random three-digit integers

$\text{Ⓜ} - [\text{Probability}] > [\text{Random Number}]$

$\text{Ⓜ} \text{ 1000Ran\#}$

EXE



(The result differs with each execution.)

Random Integer

This function generates a pseudo random integer between a specified start value and end value.

Example: To generate random integers in the range of 1 to 6

$\text{Ⓜ} - [\text{Probability}] > [\text{Random Integer}]$

$\text{Ⓜ} \text{ RanInt\#(1,6)}$

EXE

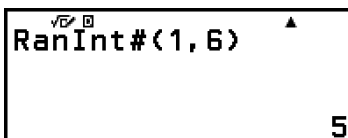

(The result differs with each execution.)

Numeric Calculations

This section explains commands and functions that you can input after performing the operation: ☞ – [Numeric Calc].

GCD, LCM

GCD determines the greatest common divisor of two values, while LCM determines the least common multiple.

Example 1: To determine the greatest common divisor of 28 and 35

$$\text{☞} - [\text{Numeric Calc}] > [\text{GCD}]$$

28 \uparrow \circlearrowright (,) 35 \circlearrowright EXE

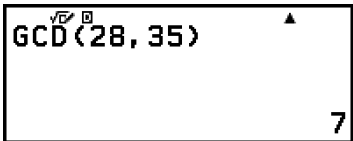

The calculator screen displays the function GCD(28, 35) and the result 7.

Example 2: To determine the least common multiple of 9 and 15

$$\text{☞} - [\text{Numeric Calc}] > [\text{LCM}]$$

9 \uparrow \circlearrowright (,) 15 \circlearrowright EXE

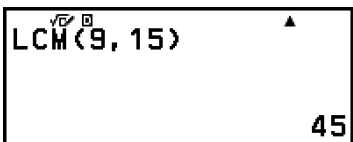

The calculator screen displays the function LCM(9, 15) and the result 45.

Absolute Value

When you are performing a real number calculation, this function simply obtains the absolute value.

Example: $|2 - 7| = \text{Abs}(2 - 7) = 5$

(Input/Output: MathI/MathO)

$$\text{☞} - [\text{Numeric Calc}] > [\text{Absolute Value}]$$

2 \ominus 7 EXE



The calculator screen displays the function |2-7| and the result 5.

(Input/Output: LineI/LineO)

$$\text{☞} - [\text{Numeric Calc}] > [\text{Absolute Value}]$$

2 \ominus 7 \circlearrowright EXE

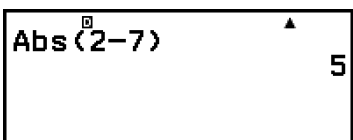

The calculator screen displays the function Abs(2-7) and the result 5.

Recurring Decimal

You can use the menu item below to input a recurring decimal.

☞ – [Numeric Calc] > [Recurring Decimal]

For details, see "[Recurring Decimal Conversion \(Recurring Decimal Calculations\)](#)" (page 41).

Round Off

Using the Round Off function (Rnd) causes decimal fraction values of the argument to be rounded in accordance with the current Number Format setting. For example, the internal and displayed result of $\text{Rnd}(10 \div 3)$ is 3.333 when the Number Format setting is Fix 3. Using the Norm 1 or Norm 2 setting cause the argument to be rounded off at the 11th digit of the mantissa part.

Example: To perform the following calculations when Fix 3 is selected for the number of display digits: $10 \div 3 \times 3$ and $\text{Rnd}(10 \div 3) \times 3$ (Input/Output: MathI/DecimalO, Number Format: Fix 3)

| | |
|--|--|
| $10 \div 3 \times 3 \text{ EXE}$ | <div style="font-size: small; margin-bottom: 5px;">√[□] □ FIX ▲</div> $10 \div 3 \times 3$ 10.000 |
| $\text{Ⓜ} - [\text{Numeric Calc}] > [\text{Round Off}]$ $10 \div 3 \text{) } \times 3 \text{ EXE}$ | <div style="font-size: small; margin-bottom: 5px;">√[□] □ FIX ▲</div> $\text{Rnd}(10 \div 3) \times 3$ 9.999 |

Angle Unit, Polar/Rectangular Coordinate, Sexagesimal

This section explains commands, functions, and symbols that you can input after performing the operation: $\text{Ⓜ} - [\text{Angle/Coord/Sexa}]$.

Degrees, Radians, Gradians

These functions specify the angle unit.

° specifies degree, ^r radian, and ^g gradian.

You can input each function using the menu items below.

- $\text{Ⓜ} - [\text{Angle/Coord/Sexa}] > [\text{Degrees}]$
- $\text{Ⓜ} - [\text{Angle/Coord/Sexa}] > [\text{Radians}]$
- $\text{Ⓜ} - [\text{Angle/Coord/Sexa}] > [\text{Gradians}]$

Example: $\pi/2$ radians = 90° (Angle Unit: Degree)

| | |
|---|--|
| $\text{Ⓜ} - [\text{Angle/Coord/Sexa}] > [\text{Radians}]$ EXE | <div style="font-size: small; margin-bottom: 5px;">√[□] □ ▲</div> $\frac{\pi}{2}^r$ 90 |
|---|--|

Hyperbolic, Trigonometric

This section explains hyperbolic and trigonometric functions.

Hyperbolic Functions

Hyperbolic functions can be input using the menu items below.

$\text{[2ND]} - [\text{Hyperbolic/Trig}] > [\text{sinh}], [\text{cosh}], [\text{tanh}], [\text{sinh}^{-1}], [\text{cosh}^{-1}], \text{ or } [\text{tanh}^{-1}]$

The angle unit setting does not affect calculations.

Example: $\sinh 1 = 1.175201194$

$\text{[2ND]} - [\text{Hyperbolic/Trig}] > [\text{sinh}] 1 \text{[)] [EXE]}$

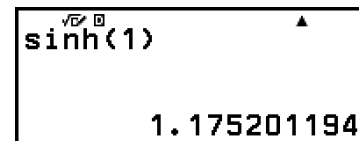

Trigonometric Functions

Trigonometric functions can be input using the keys or menu items below.

| Key | Menu Item |
|---|---|
| [sin] | $\text{[2ND]} - [\text{Hyperbolic/Trig}] > [\text{sin}]$ |
| [cos] | $\text{[2ND]} - [\text{Hyperbolic/Trig}] > [\text{cos}]$ |
| [tan] | $\text{[2ND]} - [\text{Hyperbolic/Trig}] > [\text{tan}]$ |
| $\text{[2ND]} \text{[sin]} (\text{sin}^{-1})$ | $\text{[2ND]} - [\text{Hyperbolic/Trig}] > [\text{sin}^{-1}]$ |
| $\text{[2ND]} \text{[cos]} (\text{cos}^{-1})$ | $\text{[2ND]} - [\text{Hyperbolic/Trig}] > [\text{cos}^{-1}]$ |
| $\text{[2ND]} \text{[tan]} (\text{tan}^{-1})$ | $\text{[2ND]} - [\text{Hyperbolic/Trig}] > [\text{tan}^{-1}]$ |

Specify the Angle Unit on the SETTINGS menu before performing calculations.

Example: $\sin 30 = \frac{1}{2}$ (Angle Unit: Degree)

$\text{[sin]} 30 \text{[)] [EXE]}$

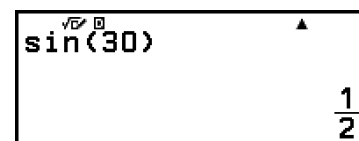

Others

Functions and symbols that can be input with the calculator keys can also be input using the [Other] menu. Use $\text{Ⓜ} - [\text{Other}]$ to display the function and symbol menu. For example, to input Ans, you could either press $\text{Ⓜ}(\text{Ans})$ or perform the following operation: $\text{Ⓜ} - [\text{Other}] > [\text{Ans}]$.

The table below shows the [Other] menu item that corresponds to each key operation.

| Menu Item | Key |
|-----------------------------|---|
| Ans | $\text{Ⓜ}(\text{Ans})$ |
| PreAns | $\text{Ⓜ}(\text{Ans})(\text{PreAns})$ |
| π | $\text{Ⓜ}(7)(\pi)$ |
| e | $\text{Ⓜ}(8)(e)$ |
| $\sqrt{\quad}$ | $\text{Ⓜ}(\sqrt{\quad})$ |
| $\sqrt[x]{\quad}$ | $\text{Ⓜ}(\sqrt{\quad})(\sqrt[x]{\quad})$ |
| -1 *1 | $\text{Ⓜ}(\text{Ⓜ}^{-1})(\text{Ⓜ}^{-1})$ |
| 2 *2 | $\text{Ⓜ}(\text{Ⓜ}^2)$ |
| ^ (| $\text{Ⓜ}(\text{Ⓜ}^{\square})$ |
| - *3 | $\text{Ⓜ}(\text{Ⓜ}^{-})(\text{Ⓜ}^{-})$ |
| , | $\text{Ⓜ}(\text{Ⓜ})(\text{Ⓜ},)$ |
| (| $\text{Ⓜ}(\text{Ⓜ}(\text{Ⓜ}))$ |
|) | $\text{Ⓜ}(\text{Ⓜ})$ |

*1 Reciprocal

*2 Square

*3 Minus sign

Registering and Using Defining Equations for $f(x)$ and $g(x)$

Registering and Using Defining Equations for $f(x)$ and $g(x)$

Your calculator includes "f(" and "g(" functions that you can use after registering defining equations for them. For example, after registering $f(x) = x^2 + 1$ as a defining equation for the "f(" function, you can calculate $f(0) = 1$ and $f(5) = 26$.

Pressing $\text{f}(x)$ displays a menu for registering the defining equation of $f(x)$ or $g(x)$, and for inputting "f(" or "g(".



Note

- The defining equations of $f(x)$ and $g(x)$ are also used by $f(x)$ and $g(x)$ in the Table app. For information about the Table app, see "[Creating a Number Table](#)" (page 86).

Registering a Defining Equation

Example 1: To register $f(x) = x^2 + 1$

1. Press MODE , select the Calculate app icon, and then press OK .
2. Press $\text{f}(x)$, and then select [Define $f(x)$].
 - This displays the $f(x)$ equation registration screen.

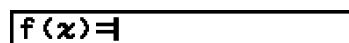

3. Input $x^2 + 1$.

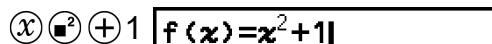

4. Press EXE .
 - This registers the expression you input, and the screen that was shown before you pressed $\text{f}(x)$ in step 2 of this procedure re-appears.

Note

- A defining equation can be registered from any calculator app except Distribution. However, depending on the screen displayed by the calculator app (for example, if a menu screen is displayed), the menu may not appear when you press $\text{f}(x)$.

Performing a Calculation by Assigning a Value to the Registered Defining Equation

Example 2: To assign the value $x = 3$ to $f(x)$, which you registered in Example 1

(Continuing from Example 1)

- Press $\text{f}(x)$, and then select $[f(x)]$.
 - This inputs "f(".

f (

- Assign a value of 3 and then execute the calculation.

3) EXE f (3) [√] [□] ▲
10

Registering a Composite Function

Example 3: To insert $f(x)$ defined in Example 1 into $g(x)$ in order to register $g(x) = f(x) \times 2 - x$

(Continuing from Example 1)

- Press $\text{f}(x)$, and then select $[Define\ g(x)]$.
 - This displays the $g(x)$ equation registration screen.

g (x) =

- Input $f(x) \times 2 - x$.

$\text{f}(x)$ * EXE (x)) \times 2 - (x) g (x) = f (x) \times 2 - x

* Pressing $\text{f}(x)$ while the $g(x)$ equation registration screen is displayed, the only menu item that appears is $[f(x)]$. In the same way, pressing $\text{f}(x)$ while the $f(x)$ equation registration screen is displayed, the only menu item that appears is $[g(x)]$.

- Press EXE .
 - This registers the equation you input and returns to the screen displayed before you started this operation with step 1.

Note

- The operation for assigning a value to x of $g(x)$ and calculating the result is the same as that under "[Performing a Calculation by Assigning a Value to the Registered Defining Equation](#)" (page 57). However, note that instead of selecting $[f(x)]$ in step 1, you should select $[g(x)]$.
- In the operation of Example 3, you input $f(x)$ into the defining equation of $g(x)$. Conversely, you can also input $g(x)$ into the $f(x)$ defining equation. However, do not

have $g(x)$ input into $f(x)$, and $f(x)$ input into $g(x)$ at the same time. If you do, a Circular ERROR will occur when you perform a calculation using $f(x)$ or $g(x)$.

Data Retention

Performing any one of the operations below causes the defining equations registered to $f(x)$ and $g(x)$ to be deleted.

- Using the SETTINGS menu to switch the Input/Output setting between MathI*¹ and LineI*².
 - *¹ MathI/MathO or MathI/DecimalO
 - *² LineI/LineO or LineI/DecimalO
- Executing ⊖ – [Reset] > [Settings & Data] or ⊖ – [Reset] > [Initialize All]

Using Verify

Verify Overview

Verify determines the authenticity of an input equality or inequality.



A calculator screen displaying the equation $2\sqrt{2} = \sqrt{8}$. The result shown is **True**. The screen also shows a small icon of a calculator and a triangle in the top right corner.



A calculator screen displaying the equation $2\sqrt{2} < \sqrt{6}$. The result shown is **False**. The screen also shows a small icon of a calculator and a triangle in the top right corner.

Verify is available with the following calculator apps.
Calculate, Table, Complex

Note

- The target and required procedure for a Verify operation depend on the calculator app where it is being used. For details, see the sections below.
 - [Using Verify with the Calculate App \(page 60\)](#)
 - [Using Verify with the Table App \(page 89\)](#)
 - [Using Verify with the Complex App \(page 94\)](#)

Enabling and Disabling Verify

To use Verify, you first need to enable it by selecting [Verify ON] on the calculator app's TOOLS menu.

Important!

- Switching Verify between enabled and disabled in the Calculate or Complex app will clear the entire calculation history.
- While Verify is enabled, a calculator app can be used only for Verify operations. It cannot be used for normal calculations. Disable Verify when you are not using it.

Note

- Verify is normally disabled after you launch a calculator app. However, if you return to the HOME screen from a calculator app after you enable Verify and then launch the

same calculator app again before launching a different calculator app, Verify will still be enabled.

To enable Verify

1. Press Δ , select the icon of the calculator app you want to launch, and then press OK .
 - Select a calculator app that can use Verify.
2. Press ooo to display the TOOLS menu.
 - Depending on the screen displayed by a calculator app, a menu may not appear when you press ooo .
3. Select [Verify ON], and then press OK .
 - This returns to the screen displayed before you pressed ooo . At this time, an \checkmark indicator appears at the top of the screen to indicate that Verify is enabled.

To disable Verify

1. Press ooo to display the TOOLS menu.
2. Select [Verify OFF], and then press OK .
 - This returns to the screen displayed before you pressed ooo , and the \checkmark indicator disappears from the top of the screen.

Note

- Verify is disabled whenever you perform any one of the following operations.
 - Pressing \downarrow
 - Pressing Δ (or S) to return to the HOME screen from the current calculator app and then launching another calculator app
 - Executing ☰ – [Reset] > [Settings & Data] or ☰ – [Reset] > [Initialize All]

Using Verify with the Calculate App

After enabling Verify in the Calculate app, you can determine if an equation or inequality is true. "True" appears on the display if the equation or inequality you input on the calculator is true, while "False" appears if it is false.

Verify Sample Operation

Enable Verify in a Calculate app before performing the operation below. For information about how to enable Verify, see ["To enable Verify" \(page 60\)](#).

Example 1: To verify whether $4\sqrt{9} = 12$ is true or false

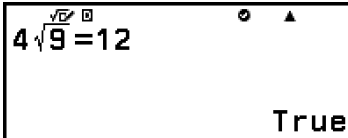
$$4 \sqrt{\square} 9 > \text{[Verify]} > [=]^* 12 \text{EXE}$$

* You can select the equality symbol or inequality symbol from the menu that appears when you press [Verify] and then select $[=]$.

Example 2: To verify whether $0 < \left(\frac{8}{9}\right)^2 - \frac{8}{9}$ is true or false

$$0 \text{[Verify]} > \text{[Verify]} > [<]$$

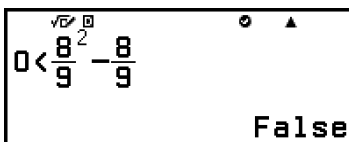
$$8 \text{[=]} 9 > \text{[]}^2 - 8 \text{[=]} 9 \text{EXE}$$

Verifiable Expressions

You can input the following expressions for verification.

- Equalities or inequalities that include one relational operator
 $4 = \sqrt{16}$, $4 \neq 3$, $\pi > 3$, $1 + 2 \leq 5$, $(3 \times 6) < (2 + 6) \times 2$, etc.
- Equalities or inequalities that include multiple relational operators
 $1 \leq 1 < 1 + 1$, $3 < \pi < 4$, $2^2 = 2 + 2 = 4$, $2 + 3 = 5 \neq 2 + 5 = 8$, etc.

Expression Input Precautions

- The following types of expressions cause a Syntax ERROR and cannot be verified.
 - An expression in which multiple relational operators that are not oriented in the same direction (Example: $5 \leq 6 \geq 4$)
 - An expression that contains two of the following operators in any combination (Example: $4 < 6 \neq 8$)
- Certain expressions that do not correspond to those described above may also produce a Syntax ERROR and cannot be verified.

Performing a Sequential Verification Operation on the Right Side of an Expression

When the result of an equality or inequality true-false verification that includes a relational operator is displayed, selecting a relational operator from the CATALOG menu inputs the right side of the expression being verified as the next line. This capability can be used to perform sequential true-false verification of an equality or inequality.

Example: Perform continuous true-false judgment of $(x + 1)(x + 5) = x^2 + x + 5x + 5$ and $x^2 + x + 5x + 5 = x^2 + 6x + 5$

| | |
|--|--|
| $((x + 1) (x + 5))$ $\oplus - [\text{Verify}] > [=]$ $(x \square^2 + (x + 5)(x + 5) \text{EXE})$ | $(x+1)(x+5)=x^2+x+5$ <p style="text-align: right;">True</p> |
| $\oplus - [\text{Verify}] > [=]$ | $x^2+x+5x+5=$ |
| $(x \square^2 + 6(x + 5) \text{EXE})$ | $x^2+x+5x+5=x^2+6x+5$ <p style="text-align: right;">True</p> |

Note

- The verification result will cause 1 to be stored to Ans memory when True and 0 when False.
- When Verify is enabled (Verify ON), the calculator performs a mathematical operation on the input expression and then displays True or False based on the result. Because of this, calculation error can occur or a mathematically correct result may not be able to be displayed when the input calculation expression includes calculation that approaches the singular point or inflection point of a function, or when the input expression contains multiple calculation operations. Also, the solution displayed when Verify is disabled (Verify OFF) may not be judged as True because the result may differ from internal data due to rounding and the limit on displayed digits. This also applies to apps other than the Calculate app.

Using QR Code Functions

Using QR Code Functions

Your calculator can display QR Code symbols that can be read by a smart device.

Important!

- The operations in this section assume that the smart device being used has a QR Code reader that can read multiple QR Code symbols, and it can connect to the Internet.
- Scanning a QR Code displayed by this calculator with a smart device will cause the smart device to access the CASIO website.

Note

- QR Code appears on the display whenever you press \uparrow (X) (QR) while any one of the screens below is displayed.
 - HOME screen
 - SETTINGS menu screen
 - Error screens
 - Calculation result screens in any calculator app
 - Table screens in any calculator app
- For details, visit the CASIO website (<https://wes.casio.com>).

Displaying a QR Code

Example: To display the QR Code for a calculation result in the calculator's Calculate app and scan it with a smart device

1. In the Calculate app, perform some calculation.
2. Press \uparrow (X) (QR) to display the QR Code.
 - The numbers in the lower right corner of the display show the current QR Code number and the total number of QR Code symbols. To display the next QR Code, press \downarrow or OK .

Note

- To return to a previous QR Code, press \downarrow or OK as many times as required to scroll forward until it appears.

3. Use a smart device to scan the QR Code on the calculator display.
 - For information about how to scan a QR Code, refer to the user documentation of the QR Code reader you are using.

If You Experience Difficulty Scanning a QR Code

While the QR Code is displayed, use ⏪ and ⏩ to adjust the display contrast of the QR Code. This contrast adjustment affects QR Code displays only.

Important!

- Depending on the smart device and/or QR Code reader app being used, you may experience problems scanning the QR Code symbols produced by this calculator.
- When the "QR Code" setting on the SETTINGS menu is "Version 3", the calculator apps that can display QR Code symbols are limited. If you try to display a QR Code in an app that does not support QR Code display, the message "Not Supported (Version 3)" will appear. However, the QR Code produced by this setting is easier to scan with a smart device.
- For more information, visit the CASIO website (<https://wes.casio.com>).

Using Calculator Apps

Statistical Calculations

The Statistics app calculates various statistical values based on single-variable (x) or paired-variable (x, y) data.

General Procedure for Performing a Statistical Calculation

1. Press 2ND , select the Statistics app icon, and then press OK .
2. On the menu that appears, select [1-Variable] (single-variable) or [2-Variable] (paired-variable), and then press OK .
 - This displays the Statistics Editor.

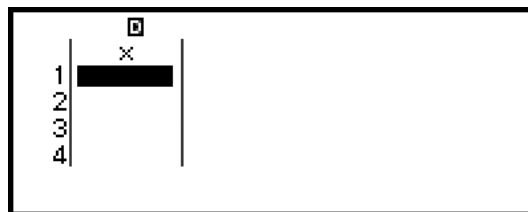

Single-variable

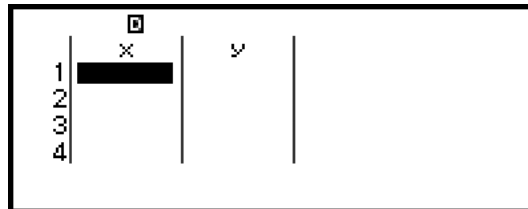

Paired-variable

3. Display the Freq (frequency) column as needed.
 - For details, see ["Freq \(Frequency\) Column" \(page 66\)](#).
4. Input data.
 - For details, see ["Inputting Data with Statistics Editor" \(page 66\)](#).
5. After you finish inputting data, press OK .
 - This causes the menu below to appear.



Single-variable



Paired-variable

6. Select the menu item for the operation you want to perform.
 - Select [1-Var Results], [2-Var Results], or [Reg Results] to see a list of calculation results based on the data you entered. For details, see ["Displaying Statistical Calculation Results" \(page 69\)](#).
 - To display a statistical calculation screen for performing calculations based on the input data, select [Statistics Calc]. For details, see ["Using Statistical Calculation Screen" \(page 73\)](#).

Note

- To return to the Statistics Editor from a statistical calculation screen, press AC and then ↩ .

Inputting Data with Statistics Editor

Statistics Editor displays one, two, or three columns: single-variable (x), single-variable and frequency (x , Freq), paired-variable (x , y), paired-variable and frequency (x , y , Freq). The number of data rows that can be input depends on the number of columns: 160 rows for one column, 80 rows for two columns, 53 rows for three columns.

Important!

- All data currently input in the Statistics Editor is deleted whenever you perform any of the operations below.
 - Switching the statistical calculation type between single-variable and paired-variable
 - Changing the Frequency setting on the TOOLS menu
- Statistical calculations can take considerable time when there are a large number of data items.

Freq (Frequency) Column

If you turn on the Frequency setting on the TOOLS menu, a column labeled "Freq" will also be included on the Statistics Editor. You can use the Freq column to specify the frequency (the number of times the same sample appears in the data group) of each sample value.

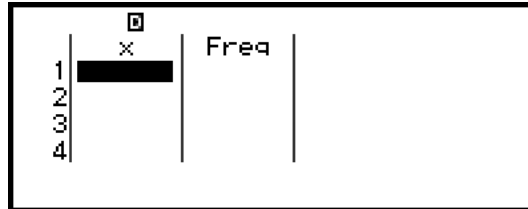

Single-variable

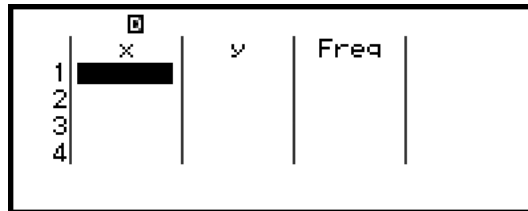

Paired-variable

To display the Freq column

1. While the Statistics Editor is displayed, press \odot and then select [Frequency] > [On].
2. Press AC to return to the Statistics Editor.

To hide the Freq column

1. While the Statistics Editor is displayed, press \odot and then select [Frequency] > [Off].
2. Press AC to return to the Statistics Editor.

Rules for Inputting Sample Data on the Statistics Editor

Data you input is inserted into the cell where the cursor is located. Use the cursor keys to move the cursor between cells.

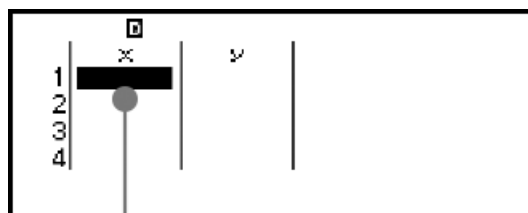

Cursor

After inputting a value, press EXE . This registers the value and displays up to six of its digits in the cell.

Example 1: To select paired-variable and input the following data: (170, 66), (179, 75), (173, 68)

1. Press 2nd , select the Statistics app icon, and then press OK .
2. Select [2-Variable], and then press OK .

| | x | y |
|---|---|---|
| 1 | | |
| 2 | | |
| 3 | | |
| 4 | | |

3. Use the operation below to input data.

170 EXE 179 EXE 173 EXE V >
 66 EXE 75 EXE 68 EXE

| | x | y |
|---|-----|----|
| 1 | 170 | 66 |
| 2 | 179 | 75 |
| 3 | 173 | 68 |
| 4 | | |

Note

- On the Statistics Editor, you can store the value in a cell to a variable. For example, performing the following operation while the screen in step 3 is displayed above will store 68 to variable A: ^ Z = A = > [Store] . For details about variables, see "[Variables \(A, B, C, D, E, F, x, y, z\)](#)" (page 35).

Editing Sample Data

To replace the data in a cell

On the Statistics Editor, move the cursor to the cell containing the data you want to edit, input the new data, and then press EXE .

To delete a row

On the Statistics Editor, move the cursor to the row you want to delete and then press DEL .

To insert a row

- On the Statistics Editor, move the cursor to the row that will be under the row you will insert.
- Perform the following operation: 000 = [Edit] > [Insert Row] .

To delete all Statistics Editor contents

On the Statistics Editor, perform the following operation: 000 = [Edit] > [Delete All] .

Sorting Data

You can sort Statistics Editor data in ascending or descending order on its x , y , or Freq-column values.

Important!

- Note that after you change the data sort sequence, you will not be able to return it to its original sequence.

Example 2: To sort the data input in **Example 1 (page 67)** in ascending order on the x column, and then in descending order on the y column

1. Use the procedure in Example 1 to input the data.

| | x | y |
|---|-----|----|
| 1 | 170 | 66 |
| 2 | 173 | 75 |
| 3 | 173 | 68 |
| 4 | | |

2. Sort the data in ascending order on the x column.

\odot – [Sort] > [x Ascending]

| | x | y |
|---|-----|----|
| 1 | 170 | 66 |
| 2 | 173 | 68 |
| 3 | 173 | 75 |
| 4 | | |

170

3. Sort the data in descending order on the y column.

\odot – [Sort] > [y Descending]

| | x | y |
|---|-----|----|
| 1 | 179 | 75 |
| 2 | 173 | 68 |
| 3 | 170 | 66 |
| 4 | | |

75

Displaying Statistical Calculation Results

Displaying Single-Variable Statistical Calculation Results

The 1-Var Results screen shows a list of various statistical values (such as mean and population standard deviation) calculated based on single-variable data. This section describes the operation required to display the 1-Var Results screen.

Example 3: To input the data below and display single-variable statistical calculation results

| x | 1 | 2 | 3 | 4 | 5 | 6 | 7 | 8 | 9 | 10 |
|------|---|---|---|---|---|---|---|---|---|----|
| Freq | 1 | 2 | 1 | 2 | 2 | 2 | 3 | 4 | 2 | 1 |

1. Press \odot , select the Statistics app icon, and then press OK .

2. Select [1-Variable], and then press OK .

- This displays the Statistics Editor.

3. Press \odot and then select [Frequency] > [On].

- Press AC to return to the Statistics Editor.

4. Input data into the x -column.

1 EXE 2 EXE 3 EXE 4 EXE 5 EXE 6 EXE 7 EXE 8 EXE 9 EXE 10 EXE

| | x | Freq |
|----|----|------|
| 8 | | 1 |
| 9 | | 1 |
| 10 | 10 | 1 |
| 11 | | |

5. Input data into the Freq column.

\odot \odot

| | | | | |
|----|---|----|------|---|
| 7 | x | 7 | Freq | 3 |
| 8 | | 8 | | 4 |
| 9 | | 9 | | 2 |
| 10 | | 10 | | 1 |

6. Press \odot .

| |
|------------------------|
| 1-Var Results |
| Statistics Calc |

7. Select [1-Var Results], and then press \odot .

- This displays the 1-Var Results screen.

| | |
|--------------|--------------|
| \bar{x} | =5.95 |
| Σx | =119 |
| Σx^2 | =837 |
| $\sigma^2 x$ | =6.4475 |
| σx | =2.539192785 |
| $s^2 x$ | =6.786842105 |

\odot (or \odot)

| | |
|-----------|--------------|
| s_x | =2.605156829 |
| n | =20 |
| $\min(x)$ | =1 |
| Q_1 | =4 |
| Med | =6.5 |
| Q_3 | =8 |

\odot (or \odot)

| | |
|-----------|-----|
| $\max(x)$ | =10 |
|-----------|-----|

- For the meanings of the variables shown on the 1-Var Results screen, see the ["List of Statistical Value Variables and Statistical Calculation Functions"](#) (page 76).

8. Press \odot or \odot to return to the Statistics Editor.

Displaying Paired-Variable Statistical Calculation Results

The 2-Var Results screen shows a list of various statistical values (such as mean and population standard deviation) calculated based on paired-variable data. This section describes the operation required to display the 2-Var Results screen.

Example 4: To input the data below and display paired-variable statistical calculation results

| | | | | | | | | | | |
|-----|-----|-----|-----|-----|-----|-----|-----|-----|-----|-----|
| x | 1.0 | 1.2 | 1.5 | 1.6 | 1.9 | 2.1 | 2.4 | 2.5 | 2.7 | 3.0 |
| y | 1.0 | 1.1 | 1.2 | 1.3 | 1.4 | 1.5 | 1.6 | 1.7 | 1.8 | 2.0 |

- Press \odot , select the Statistics app icon, and then press \odot .
- Select [2-Variable], and then press \odot .
 - This displays the Statistics Editor.
- Input data into the x -column.

1 EXE 1 \cdot 2 EXE 1 \cdot 5 EXE 1 \cdot 6 EXE 1 \cdot 9 EXE
 2 \cdot 1 EXE 2 \cdot 4 EXE 2 \cdot 5 EXE 2 \cdot 7 EXE 3 EXE

| | x | y |
|----|-----|---|
| 8 | 2.5 | 0 |
| 9 | 2.7 | 0 |
| 10 | 3 | 0 |
| 11 | | |

4. Input data into the y -column.

V > 1 EXE 1 \cdot 1 EXE 1 \cdot 2 EXE 1 \cdot 3 EXE 1 \cdot 4 EXE
 1 \cdot 5 EXE 1 \cdot 6 EXE 1 \cdot 7 EXE 1 \cdot 8 EXE 2 EXE

| | x | y |
|----|-----|-----|
| 8 | 2.5 | 1.7 |
| 9 | 2.7 | 1.8 |
| 10 | 3 | 2 |
| 11 | | |

5. Press OK .

| |
|---------------------------------------|
| 2-Var Results |
| Reg Results \blacktriangleright |
| Statistics Calc \blacktriangleright |

6. Select [2-Var Results], and then press OK .

- This displays the 2-Var Results screen.

| | |
|--------------|---------|
| \bar{x} | =1.99 |
| Σx | =19.9 |
| Σx^2 | =43.57 |
| $\sigma^2 x$ | =0.3969 |
| σx | =0.63 |
| $s^2 x$ | =0.441 |

V (or V)

| | |
|--------------|---------------|
| \bar{y} | =0.6640783086 |
| n | =10 |
| \bar{y} | =1.46 |
| Σy | =14.6 |
| Σy^2 | =22.24 |
| $\sigma^2 y$ | =0.0924 |

V (or V)

| | |
|----------------|---------------|
| σy | =0.3039736831 |
| $s^2 y$ | =0.1026666667 |
| \bar{y} | =0.3204163958 |
| Σxy | =30.96 |
| Σx^3 | =102.451 |
| $\Sigma x^2 y$ | =71.244 |

V (or V)

| | |
|-----------------|-----------|
| Σx^4 | =253.5541 |
| $\text{min}(x)$ | =1 |
| $\text{max}(x)$ | =3 |
| $\text{min}(y)$ | =1 |
| $\text{max}(y)$ | =2 |

- For the meanings of the variables shown on the 2-Var Results screen, see the ["List of Statistical Value Variables and Statistical Calculation Functions" \(page 76\)](#).

7. Press 2nd or AC to return to the Statistics Editor.

Displaying Regression Calculation Results

The Reg Results screen displays a list of regression calculation results (coefficients of regression equations) based on paired-variable data. This section describes the operation required to display the Reg Results screen.

Example 5: To use the paired-variable data input in [Example 4 \(page 70\)](#) and display the results of the two regression calculations shown below

- The regression equation " $y = a + bx$ " coefficients (a , b), and the correlation coefficient (r) when linear regression is performed on the data
- The regression equation " $y = a + bx + cx^2$ " coefficients (a , b , c) when quadratic regression is performed on the data

Note

- For information about regression calculation types supported by the Statistics app, see the ["Supported Regression Type List" \(page 73\)](#).

1. Perform steps 1 through 5 of the procedure under [Example 4 \(page 70\)](#).
2. Select [Reg Results], and then press **OK**.
 - This displays the regression type menu.

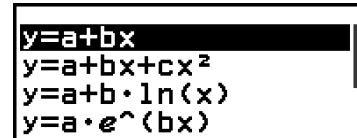

```

y=a+bx
y=a+bx+cx^2
y=a+b*ln(x)
y=a*e^(bx)
  
```

3. Select [$y=a+bx$], and then press **OK**.
 - This displays the linear regression Reg Results screen.

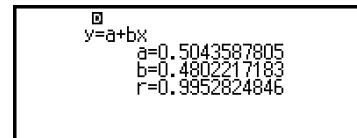

```

y=a+bx
a=0.5043587805
b=0.4802217183
r=0.9952824846
  
```

4. Press **↵** or **AC** to return to the Statistics Editor.
5. Press **OK**, and then select [Reg Results] > [$y=a+bx+cx^2$].
 - This displays quadratic regression Reg Results screen.

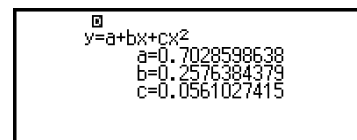

```

y=a+bx+cx^2
a=0.7028598638
b=0.2576384379
c=0.0561027415
  
```

6. Press **↵** or **AC** to return to the Statistics Editor.
 - For the meanings of the variables shown on the Reg Results screen, see the ["List of Statistical Value Variables and Statistical Calculation Functions" \(page 76\)](#).

Supported Regression Type List

| Regression Type | Regression Equation (regression type menu item) |
|----------------------------------|--|
| Linear Regression | $y = a + bx$ |
| Quadratic Regression | $y = a + bx + cx^2$ |
| Logarithmic Regression | $y = a + b \cdot \ln(x)$ |
| <i>e</i> exponential Regression | $y = a \cdot e^{(bx)}$ |
| <i>ab</i> exponential Regression | $y = a \cdot b^x$ |
| Power Regression | $y = a \cdot x^b$ |
| Inverse Regression | $y = a + b/x$ |

Using Statistical Calculation Screen

You can use the statistical calculation screen to recall individual statistical values and use the values in calculations.



Screen without calculation expression input

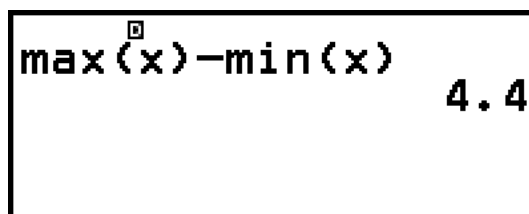

Example calculation

To recall a statistical value, use a variable representing the statistical value you want to recall (for example, \bar{x} , x population standard deviation: σ_x , x maximum value: $\max(x)$, and so on). For more information about these variables, see the ["List of Statistical Value Variables and Statistical Calculation Functions"](#) (page 76).

Displaying a Statistical Calculation Screen

Single-variable

1. While the Statistics Editor is displayed, press OK .
2. On the menu that appears, select [Statistics Calc] and then press OK .



Paired-variable

1. While the Statistics Editor is displayed, press OK .
2. On the menu that appears, select [Statistics Calc] and then press OK .
 - This displays the regression type menu (see the "[Supported Regression Type List](#)" (page 73)).

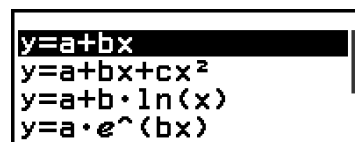

3. On the menu, select the regression type you want and then press OK .



- In the example above, use the displayed menu to select [$y=a+bx$] (Linear regression).

To return to the Statistics Editor from a statistical calculation screen

Press AC , and then D .

Calculation Example Using the Statistical Calculation Screen

Example 6: To determine the sum of the sample data (Σx) and mean (\bar{x}) of the single-variable data input in [Example 3 \(page 69\)](#)

1. Perform steps 1 through 6 of the procedure under [Example 3 \(page 69\)](#).
2. Select [Statistics Calc], and then press OK .



3. Calculate the sum of the sample data (Σx).

$\text{2ND} - [\text{Statistics}] > [\text{Summation}] > [\Sigma x]$

4. Calculate the mean (\bar{x}).

$\text{2ND} - [\text{Statistics}] > [\text{Mean/Var/Dev}\dots] > [\bar{x}]$

Note

- To display the 1-Var Results screen from the statistical calculation screen above, press 2ND and then select [1-Var Results]. To return to the statistical calculation screen from the 1-Var Results screen, press 2ND or AC .

Example 7: To determine the coefficients (a , b) and correlation coefficient (r) of the linear regression equation " $y = a + bx$ " based on the paired-variable data input in [Example 4 \(page 70\)](#)

- Perform steps 1 through 5 of the procedure under [Example 4 \(page 70\)](#).
- Select [Statistics Calc], and then press OK .
 - This displays the regression type menu.

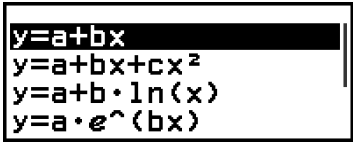

- Select [$y=a+bx$], and then press OK .

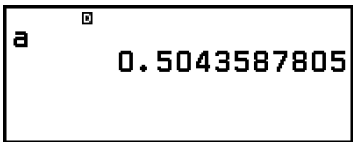

- Determine the coefficients (a , b) and correlation coefficient (r) of the regression equation " $y = a + bx$ ".

$\text{2ND} - [\text{Statistics}] > [\text{Regression}] > [a]$

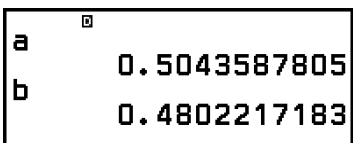
$\text{2ND} - [\text{Statistics}] > [\text{Regression}] > [b]$

\square – [Statistics] > [Regression] > [r]

\square

| | |
|---|--------------|
| b | 0.4802217183 |
| r | 0.9952824846 |

- To select a different regression type, press \square and then select [Select Reg Type]. This displays the regression type menu from step 2.

To display the 2-Var Results screen from a statistical calculation screen

Press \square and then select [2-Var Results].

To display the Reg Results screen from a statistical calculation screen

Press \square and then select [Reg Results].

List of Statistical Value Variables and Statistical Calculation Functions

You can use the CATALOG menu to recall variables representing statistical values and functions used for statistical calculations.

Note

- For single-variable statistical calculations, the variables marked with an asterisk (*) are available.
- For the calculation formula used for each variable and command, see "[Statistical Calculation Formula](#)" (page 78).

\square – [Statistics] > [Summation]

- Σx^* , Σy sum of the sample data
- Σx^{2*} , Σy^2 sum of squares of the sample data
- Σxy sum of products of the x -data and y -data
- Σx^3 sum of cubes of the x -data
- Σx^2y sum of (x -data squares \times y -data)
- Σx^4 sum of biquadrate of the x -data

\square – [Statistics] > [Mean/Var/Dev...]

- \bar{x}^* , \bar{y} mean
- σ_x^2 , σ_y^2 population variance
- σ_x , σ_y population standard deviation
- s_x^2 , s_y^2 sample variance
- s_x , s_y sample standard deviation
- n^* number of items

\square – [Statistics] > [Min/Max/Quartile] (Single-Variable Data Only)

$\min(x)^*$ minimum value
 Q_1^* first quartile
 Med^* median
 Q_3^* third quartile
 $\max(x)^*$ maximum value

☞ – **[Statistics] > [Min/Max]** (Paired-Variable Data Only)

$\min(x), \min(y)$ minimum value
 $\max(x), \max(y)$ maximum value

☞ – **[Statistics] > [Regression]** (Paired-Variable Data Only)

For quadratic regression

a, b, c regression coefficients for quadratic regression
 \hat{x}_1, \hat{x}_2 Functions for determining x_1 and x_2 estimated values for an input y -value. For the argument, input the value of y immediately before the \hat{x}_1 or \hat{x}_2 function.
 \hat{y} Function for determining the y estimated value for an input x -value. For the argument, input the value of x immediately before this function.

For non-quadratic regression

a, b regression coefficients
 r correlation coefficient
 \hat{x} Function for determining x estimated value for an input y -value. For the argument, input the value of y immediately before this function.
 \hat{y} Function for determining the y estimated value for an input x -value. For the argument, input the value of x immediately before this function.

For an example of the operation to determine estimated values, see ["Calculating Estimated Values \(Paired-Variable Data Only\)" \(page 77\)](#).

Calculating Estimated Values (Paired-Variable Data Only)

Based on the regression equation obtained by paired-variable statistical calculation, the estimated value of y can be calculated for a given x -value. The corresponding x -value (two values, x_1 and x_2 , in the case of quadratic regression) also can be calculated for a value of y in the regression equation.

Example 8: To determine the estimated value for y when $x = 5.5$ in the regression equation produced by linear regression of the data input in [Example 4 \(page 70\)](#)

1. Perform steps 1 through 5 of the procedure under [Example 4 \(page 70\)](#).
2. Select [Statistics Calc], and then press OK .
 - This displays the regression type menu.

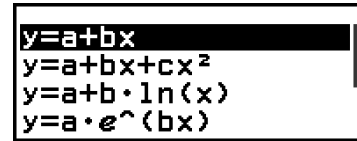

3. Select [$y=a+bx$], and then press OK .



4. Input the x -value (5.5), and then input " \hat{y} ", which is the function to determine the estimated value of y .

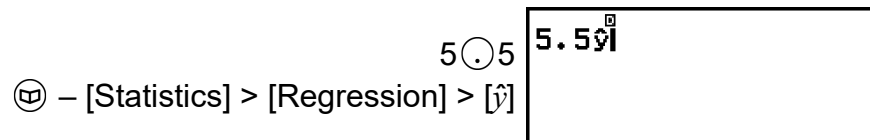

5. Press EXE .

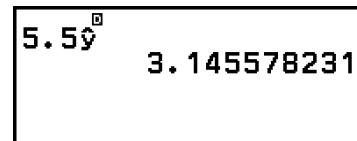

Statistical Calculation Formula

Single-Variable Statistical Calculation Formula

$$\bar{x} = \frac{\sum x}{n}$$

$$\sigma_x = \sqrt{\frac{\sum (x - \bar{x})^2}{n}}$$

$$s_x = \sqrt{\frac{\sum (x - \bar{x})^2}{n - 1}}$$

Paired-Variable Statistical Calculation Formula

$$\bar{x} = \frac{\sum x}{n}$$

$$\sigma_x = \sqrt{\frac{\sum (x - \bar{x})^2}{n}}$$

$$s_x = \sqrt{\frac{\sum (x - \bar{x})^2}{n - 1}}$$

$$\bar{y} = \frac{\sum y}{n}$$

$$\sigma_y = \sqrt{\frac{\sum (y - \bar{y})^2}{n}}$$

$$s_y = \sqrt{\frac{\sum (y - \bar{y})^2}{n - 1}}$$

Regression Calculation Formula

Linear Regression ($y = a + bx$)

$$a = \frac{\sum y - b \cdot \sum x}{n}$$

$$b = \frac{n \cdot \sum xy - \sum x \cdot \sum y}{n \cdot \sum x^2 - (\sum x)^2}$$

$$r = \frac{n \cdot \sum xy - \sum x \cdot \sum y}{\sqrt{\{n \cdot \sum x^2 - (\sum x)^2\} \{n \cdot \sum y^2 - (\sum y)^2\}}}$$

$$\hat{x} = \frac{y - a}{b}$$

$$\hat{y} = a + bx$$

Quadratic Regression ($y = a + bx + cx^2$)

$$a = \frac{\sum y}{n} - b \left(\frac{\sum x}{n} \right) - c \left(\frac{\sum x^2}{n} \right)$$

$$b = \frac{S_{xy} \cdot S_{x^2 x^2} - S_{x^2 y} \cdot S_{xx^2}}{S_{xx} \cdot S_{x^2 x^2} - (S_{xx^2})^2}$$

$$c = \frac{S_{x^2 y} \cdot S_{xx} - S_{xy} \cdot S_{xx^2}}{S_{xx} \cdot S_{x^2 x^2} - (S_{xx^2})^2}$$

$$S_{xx} = \sum x^2 - \frac{(\sum x)^2}{n}$$

$$S_{xy} = \sum xy - \frac{(\sum x \cdot \sum y)}{n}$$

$$S_{xx^2} = \sum x^3 - \frac{(\sum x \cdot \sum x^2)}{n}$$

$$S_{x^2 x^2} = \sum x^4 - \frac{(\sum x^2)^2}{n}$$

$$S_{x^2 y} = \sum x^2 y - \frac{(\sum x^2 \cdot \sum y)}{n}$$

$$\hat{x}_1 = \frac{-b + \sqrt{b^2 - 4c(a - y)}}{2c}$$

$$\hat{x}_2 = \frac{-b - \sqrt{b^2 - 4c(a - y)}}{2c}$$

$$\hat{y} = a + bx + cx^2$$

Logarithmic Regression ($y = a + b \cdot \ln(x)$)

$$a = \frac{\sum y - b \cdot \sum \ln x}{n}$$

$$b = \frac{n \cdot \sum(\ln x)y - \sum \ln x \cdot \sum y}{n \cdot \sum(\ln x)^2 - (\sum \ln x)^2}$$

$$r = \frac{n \cdot \sum(\ln x)y - \sum \ln x \cdot \sum y}{\sqrt{\{n \cdot \sum(\ln x)^2 - (\sum \ln x)^2\} \{n \cdot \sum y^2 - (\sum y)^2\}}}$$

$$\hat{x} = e^{\frac{y-a}{b}}$$

$$\hat{y} = a + b \ln x$$

e Exponential Regression ($y = a \cdot e^{(bx)}$)

$$a = \exp\left(\frac{\sum \ln y - b \cdot \sum x}{n}\right)$$

$$b = \frac{n \cdot \sum x \ln y - \sum x \cdot \sum \ln y}{n \cdot \sum x^2 - (\sum x)^2}$$

$$r = \frac{n \cdot \sum x \ln y - \sum x \cdot \sum \ln y}{\sqrt{\{n \cdot \sum x^2 - (\sum x)^2\} \{n \cdot \sum (\ln y)^2 - (\sum \ln y)^2\}}}$$

$$\hat{x} = \frac{\ln y - \ln a}{b}$$

$$\hat{y} = a e^{bx}$$

ab Exponential Regression ($y = a \cdot b^x$)

$$a = \exp\left(\frac{\sum \ln y - \ln b \cdot \sum x}{n}\right)$$

$$b = \exp\left(\frac{n \cdot \sum x \ln y - \sum x \cdot \sum \ln y}{n \cdot \sum x^2 - (\sum x)^2}\right)$$

$$r = \frac{n \cdot \sum x \ln y - \sum x \cdot \sum \ln y}{\sqrt{\{n \cdot \sum x^2 - (\sum x)^2\} \{n \cdot \sum (\ln y)^2 - (\sum \ln y)^2\}}}$$

$$\hat{x} = \frac{\ln y - \ln a}{\ln b}$$

$$\hat{y} = a b^x$$

Power Regression ($y = a \cdot x^b$)

$$a = \exp\left(\frac{\sum \ln y - b \cdot \sum \ln x}{n}\right)$$

$$b = \frac{n \cdot \sum \ln x \ln y - \sum \ln x \cdot \sum \ln y}{n \cdot \sum (\ln x)^2 - (\sum \ln x)^2}$$

$$r = \frac{n \cdot \sum \ln x \ln y - \sum \ln x \cdot \sum \ln y}{\sqrt{\{n \cdot \sum (\ln x)^2 - (\sum \ln x)^2\} \{n \cdot \sum (\ln y)^2 - (\sum \ln y)^2\}}}$$

$$\hat{x} = e^{\frac{\ln y - \ln a}{b}}$$

$$\hat{y} = a x^b$$

Inverse Regression ($y = a + b/x$)

$$a = \frac{\sum y - b \cdot \sum x^{-1}}{n}$$

$$b = \frac{S_{xy}}{S_{xx}}$$

$$r = \frac{S_{xy}}{\sqrt{S_{xx} \cdot S_{yy}}}$$

$$S_{xx} = \Sigma(x^{-1})^2 - \frac{(\Sigma x^{-1})^2}{n}$$

$$S_{yy} = \Sigma y^2 - \frac{(\Sigma y)^2}{n}$$

$$S_{xy} = \Sigma(x^{-1})y - \frac{\Sigma x^{-1} \cdot \Sigma y}{n}$$

$$\hat{x} = \frac{b}{y - a}$$

$$\hat{y} = a + \frac{b}{x}$$

Distribution Calculations

In the Distribution app, you can obtain the probability value by selecting the distribution calculation type and inputting various parameters.* Executable distribution calculation types are shown in the table below.

| Distribution Calculation Type | Menu Item |
|---|----------------|
| Binomial probability | Binomial PD |
| Binomial cumulative probability | Binomial CD |
| Normal probability density | Normal PD |
| Normal cumulative probability | Normal CD |
| Inverse normal cumulative distribution* | Inverse Normal |
| Poisson probability | Poisson PD |
| Poisson cumulative probability | Poisson CD |

* "Inverse Normal" performs inverse calculation to determine the data value (x_{Inv}) from a probability value (Area1).

General Procedure for Performing a Distribution Calculation

Example: To calculate binomial cumulative probability for the x data {2, 3, 4, 5} when N (number of trials) = 5 and p (probability of success) = 0.5

- Press \odot , select the Distribution app icon, and then press OK .
 - This displays the distribution calculation type menu.

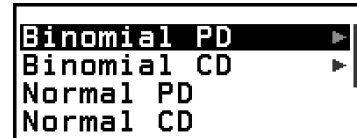

- On the menu, select a distribution calculation type.
 - Here we want to calculate binomial cumulative probability. Select [Binomial CD], and then press OK .
- On the menu that appears, select a data (x) input method.



[List] ... Select to input multiple x -data items at the same time. Selecting this menu item causes the list screen to appear.

[Variable] ... Select to input a single x -data item. Selecting this menu item causes a parameter input screen to appear.

- Here we want to input multiple x -data items at the same time, select [List] and then press OK .

- On the list screen, input x data {2, 3, 4, 5}.

2 EXE 3 EXE 4 EXE 5 EXE

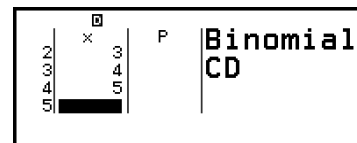

- Press OK .
 - This displays the Binomial CD parameter input screen.
- Input values for the parameters ($N = 5$, $p = 0.5$).

5 EXE 0 \odot 5 EXE

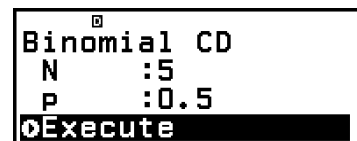

- The parameters that require data input depend on the calculation type you selected in step 2 of this procedure. For details, see the ["Parameter List" \(page 83\)](#).

- After inputting values for all of the variables, select [Execute] and then press OK .
 - This displays the calculation result screen.

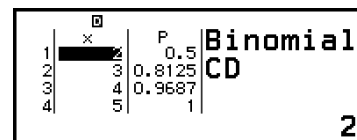

- If you selected [List] in step 3, calculation results (P column) will appear on the list screen. For details, see ["List Screen" \(page 84\)](#).
- If you perform any editing operation (see ["Editing the List Screen Contents" \(page 85\)](#)) on the list screen while calculation results are displayed, all the calculation results will be cleared. The list will return to its state in step 4 (list screen data input complete) of this procedure.
- An error message appears if the input value is outside the allowable range. "ERROR" will appear in the P column of the calculation result screen when the value input for the corresponding data is outside the allowable range.
- Pressing $\textcircled{\text{OK}}$ while the calculation result screen is displayed will return to the parameter input screen.

Note

- If you selected Normal PD, Normal CD, or Inverse Normal in step 2 above, the data (x) input method is always "Variable" (single x -data item input). Because of this, the menu in step 3 is not displayed at this time.
- If the data (x) input method is "Variable", the calculation result will be stored in Ans memory.
- Distribution calculation accuracy is up to 6 significant digits.

Parameter List

The list below shows the meanings of the symbols that appear on the parameter input screen.

Binomial PD, Binomial CD

x ... data

N ... number of trials

p ... probability of success ($0 \leq p \leq 1$)

Normal PD

x ... data

μ ... population mean

σ ... population standard deviation ($\sigma > 0$)

Normal CD

Lower ... lower boundary

Upper ... upper boundary

μ ... population mean

σ ... population standard deviation ($\sigma > 0$)

Inverse Normal

Area1 ... probability value ($0 \leq \text{Area1} \leq 1$)

μ ... population mean

σ ... population standard deviation ($\sigma > 0$)
(Tail setting always left.)

Poisson PD, Poisson CD

x ... data

λ ... mean

Note

- The last value input for each parameter name is retained, regardless of the input screen where it is input. For example, inputting a value for N on the Binomial PD parameter input screen will also change the value of N on the Binomial CD parameter input screen.
- The values you input for each of the parameters are retained as long as you do not execute either of the following operations: $\text{☰} - [\text{Reset}] > [\text{Settings \& Data}]$ or $\text{☰} - [\text{Reset}] > [\text{Initialize All}]$.

List Screen

You can use the list screen to input up to 45 x -data items. Calculation results are also displayed on the list screen.

| x | P |
|-----|--------|
| 1 | 0.5 |
| 2 | 0.8125 |
| 3 | 0.9687 |
| 4 | 1 |

- (1) Distribution calculation type
- (2) Value at current cursor position
- (3) Data (x)
- (4) Calculation results (P)

Note

- On the list screen, you can store the value in a cell to a variable. For example, performing the following operation while the above screen is displayed will store 1 to variable A: $\text{☰} - [A=] > [\text{Store}]$. For details about variables, see "[Variables \(A, B, C, D, E, F, x, y, z\)](#)" (page 35).
- Performing one of the operations below deletes all x -data input on the list screen.
 - Returning to the HOME screen and launching another calculator app
 - Executing [Delete All] (See "[To delete all list screen contents](#)" (page 85).)
 - Executing $\text{☰} - [\text{Reset}] > [\text{Settings \& Data}]$ or $\text{☰} - [\text{Reset}] > [\text{Initialize All}]$

Editing the List Screen Contents

To change the x data in a cell

On the list screen, move the cursor to the cell containing the data you want to change, input the new data, and then press EXE .

To delete a row

On the list screen, move the cursor to the row you want to delete and then press DEL .

To insert a row

1. On the list screen, move the cursor to the row that will be under the row you will insert.
2. Perform the following operation: $\text{MODE} - [\text{Edit}] > [\text{Insert Row}]$.
 - This inserts a row with 0 input as the initial default value.

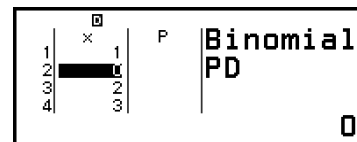

3. Input the data.

To delete all list screen contents

On the list screen, perform the following operation: $\text{MODE} - [\text{Edit}] > [\text{Delete All}]$.

Calculation Example

To calculate the normal probability density when $x = 36$, $\mu = 35$, $\sigma = 2$

1. Press MODE , select the Distribution app icon, and then press OK .
2. On the distribution calculation type menu that appears, select [Normal PD], and then press OK .
 - This displays the Normal PD parameter input screen.
3. Input values for the parameters ($x = 36$, $\mu = 35$, $\sigma = 2$).



4. Press OK .

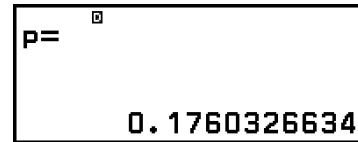

- Pressing OK again or pressing ↵ or AC returns to the parameter input screen in step 3 of this procedure.
- You can store the currently displayed calculation result to a variable. For example, performing the following operation while the screen in step 4 is displayed above will store the calculation result to variable A: $\text{2nd} \text{ [A=]} > [\text{Store}]$. For details about variables, see "[Variables \(A, B, C, D, E, F, x, y, z\)](#)" (page 35).

Creating a Number Table

You can use the Table app to create a number table based on the defining equations registered for functions $f(x)$ and $g(x)$.

General Procedure for Creating a Number Table

Example : To generate a number table for the functions $f(x) = x^2 + \frac{1}{2}$ and $g(x) = x^2 - \frac{1}{2}$ for the range $-1 \leq x \leq 1$, incremented in steps of 0.5

1. Press 2nd , select the Table app icon, and then press OK .
 - This displays the number table screen.
 - If a defining equation is not registered for either or both of $f(x)$ and $g(x)$ and the data at the cursor selection position is empty, a message will appear at the bottom of the screen indicating that the defining equation is not registered.

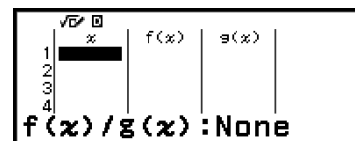

2. Configure settings to generate a number table from two functions.
 - (1) Press 2nd , and then select [Table Type] > [f(x)/g(x)].
 - (2) Press AC .
 - For information about settings, see "[Maximum Number of Rows in a Number Table According to Table Type](#)" (page 87).
3. Register a defining equation for $f(x)$.



(Screen immediately before you pressed EXE)

4. Register a defining equation for $g(x)$.

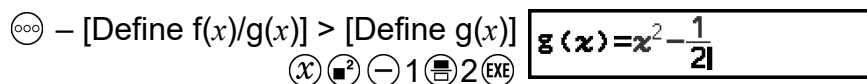

(Screen immediately before you pressed (EXE))

- You can also use (f00) to register a defining expression. For more information, see ["Defining Equation Registration" \(page 88\)](#).

5. Configure the number table range setting.

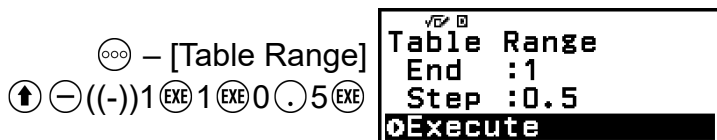

6. Press (EXE).

- This displays the result in the number table screen.

| x | $f(x)$ | $g(x)$ |
|------|--------|--------|
| -1 | 1.5 | 0.5 |
| -0.5 | 0.75 | -0.25 |
| 0 | 0.5 | -0.5 |
| 0.5 | 0.75 | -0.25 |

- 1

- The number table generation operation causes the contents of variable x to be changed.

Note

- On the number table screen, you can store the value in a cell to a variable. For example, performing the following operation while the screen in step 6 is displayed above will store -1 to variable A: (←) (-) 1 (EXE) (A=) (EXE) [Store]. For details about variables, see ["Variables \(A, B, C, D, E, F, x, y, z\)" \(page 35\)](#).

Maximum Number of Rows in a Number Table According to Table Type

You can configure number table screen settings to show columns for both $f(x)$ and $g(x)$, or for either one of them. To set it, use the menu that appears when you press (000) - [Table Type] while the number table screen is displayed.

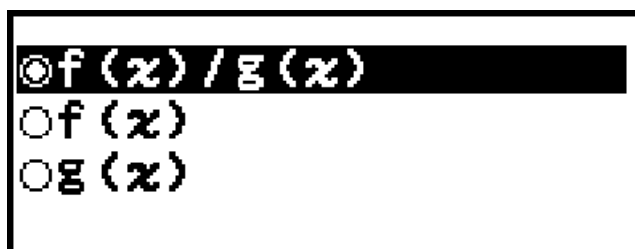

$f(x)/g(x)$... Show both $f(x)$ - and $g(x)$ -columns (initial default setting)

$f(x)$... Show only $f(x)$ -column

$g(x)$... Show only $g(x)$ -column

The maximum number of rows in the generated number table depends on the Table Type setting. Up to 45 rows are supported for the "f(x)" or "g(x)" setting, while 30 rows are supported for the "f(x)/g(x)" setting.

Defining Equation Registration

There are two ways to register defining equations for $f(x)$ and $g(x)$.

- While the Table app number table screen is displayed, registering an equation by pressing $\odot\odot\odot$
 - $\odot\odot\odot$ – [Define f(x)/g(x)] > [Define f(x)]
 - $\odot\odot\odot$ – [Define f(x)/g(x)] > [Define g(x)]
- While the Table app number table screen is displayed, or while using any calculator app except Distribution, registering an equation by pressing $\textcircled{f(x)}$
 - $\textcircled{f(x)}$ – [Define f(x)]
 - $\textcircled{f(x)}$ – [Define g(x)]

The same $f(x)$ or $g(x)$ equation registration screen appears regardless of which of the two above operations is used to register defining equations.

Note

- For details about operations using $\textcircled{f(x)}$, see "[Registering and Using Defining Equations for f\(x\) and g\(x\)](#)" (page 56).

Editing Number Table Screen Data

To delete a row

1. On the number table screen, move the cursor to the row you want to delete.
2. Press $\textcircled{\times}$.

To insert a row

1. On the number table screen, move the cursor to the row that will be under the row you will insert.
2. Perform the following operation: $\odot\odot\odot$ – [Edit] > [Insert Row].

To delete all number table screen contents

On the number table screen, perform the following operation: $\odot\odot\odot$ – [Edit] > [Delete All].

To change the value input in a cell in column x

You can change the value in the currently highlighted x cell. Changing the x value causes the $f(x)$ and $g(x)$ values in the same row to be updated accordingly.

To enter a value into the highlighted x -column cell using: {value of the cell above} +/- {step value}

If there is value in the x cell above the currently highlighted x cell, pressing \oplus or EXE automatically inputs into the highlighted cell the value equal to the value of the cell above it plus the step value. So also, pressing \ominus automatically inputs the value equal to the value of the cell above less the step value. The $f(x)$ and $g(x)$ values in the same row are also updated accordingly.

$f(x)$ and $g(x)$ Update Timing

$f(x)$ and $g(x)$ values displayed on the number table screen are updated when any of the following occurs.

- When EXE is pressed while [Execute] is selected on the Table Range screen.
- When the defining equations for $f(x)$ and $g(x)$ are updated (except when a defining equation is a composite function).
- When a number is input into column x (including pressing \oplus , \ominus , EXE in column x).
- When Verify is switched from enabled to disabled (OFF – [Verify OFF]).

Note, however, that values are not updated automatically after the following operations.

- When the SETTINGS menu is used to change the Angle Unit setting.
- When the variable of a defining equation is updated (new numeric value stored) when a defining equation that contains a variable (example: $f(x) = 2x + A$) is registered.
- When the defining equation of a composite function (Example: $g(x) = f(x) \times 2 - x$) is registered, and the defining equation of the reference function (Example: $f(x)$ of $g(x) = f(x) \times 2 - x$) is updated (new defining equation registered).

In these cases, execute OFF – [Recalculate] while the number table screen is displayed to update values.

Using Verify with the Table App

If Verify is enabled in the Table app, every time you input an $f(x)$ value (or a $g(x)$ value) that corresponds to x on the number table screen, the calculator will determine if the value is true.

Note

- Verify can be used with various calculator apps. Before performing the operations in this section, first read the information in **"Verify Overview" (page 59)**.

Verify Sample Operation

This sample operation begins with a number table that has been created according to the following settings.

Defining equation $f(x) = x^2 + \frac{1}{2}$ $g(x) = x^2 - \frac{1}{2}$

Table Range Start: -1, End: 1, Step: 0.5

Perform the procedure continuing from step 6 under **"General Procedure for Creating a Number Table" (page 86)**.

- To enable Verify, press \odot and then select [Verify ON].
 - An \checkmark indicator appears at the top of the screen to indicate that Verify is enabled.
 - This deletes all of the contents of the $f(x)$ - and $g(x)$ -columns of the number table screen.

| | x | f(x) | g(x) |
|---|------|------|------|
| 1 | -1 | | |
| 2 | -0.5 | | |
| 3 | 0 | | |
| 4 | 0.5 | | |

- Press \rightarrow to move the cursor to the first row of column $f(x)$.

| | x | f(x) | g(x) |
|---|------|------|------|
| 1 | -1 | | |
| 2 | -0.5 | | |
| 3 | 0 | | |
| 4 | 0.5 | | |

- Input the $f(x)$ value (1.5) that corresponds to $x = 1$.

1 \odot 5 EXE

- "True" is displayed if the input value is true.
 - "False" is displayed if the input value is false. Press \leftarrow , AC , or OK to return to the number table screen and re-input the number.
- If "True" is displayed, press \leftarrow , AC , or OK .
 - This returns to the number table screen and moves the cursor to the next row.

| | x | f(x) | g(x) |
|---|------|------|------|
| 1 | -1 | 1.5 | |
| 2 | -0.5 | | |
| 3 | 0 | | |
| 4 | 0.5 | | |

- You can continue to input $f(x)$ and $g(x)$ values for x . Each time you input a value, the calculator determines whether it is true.
5. To disable Verify and end the Verify operation, press \odot and then select [Verify OFF].
- This causes the \checkmark indicator to disappear from the screen.
 - For details about the operation to disable Verify, see ["To disable Verify" \(page 60\)](#).
 - Any changes you made to or new values you input into the x -column values of the number table screen while Verify was enabled are retained. When you disable Verify, the $f(x)$ - and $g(x)$ -columns are recalculated in accordance with the values in the x -column.

Note

- If the verification result is "True", the value input into the $f(x)$ - or $g(x)$ -column can be stored to a variable. For example, performing the following operation while the screen in step 4 is displayed above will store 1.5 to variable A: $\wedge \text{2.3} - [\text{A=}] > [\text{Store}]$. For details about variables, see ["Variables \(A, B, C, D, E, F, x, y, z\)" \(page 35\)](#).
- You can change the value in a cell by moving the cursor to the cell in column x and inputting a new value. Changing the value in an x cell causes the values in columns $f(x)$ and $g(x)$ to be deleted.
- You can also input a value into an x -column cell that does not contain a value (if the maximum number of rows is not exceeded yet). For information about the maximum number of rows, see ["Maximum Number of Rows in a Number Table According to Table Type" \(page 87\)](#).
- Pressing \odot while Verify is enabled disables Verify and simultaneously deletes all data currently input in the number table.

To delete all the contents of the $f(x)$ - and $g(x)$ -columns

When Verify is enabled, the contents of the $f(x)$ - and $g(x)$ -columns can be batch deleted. On the number table screen, perform the following operation: $\odot - [\text{Edit}] > [\text{Delete f/g Column}]$.

Data Retention

Doing the following will discard some data and clear some settings of the Table app.

- ① Returning to the HOME screen and launching another calculator app.
- ② Pressing \odot .
- ③ Changing the Input/Output setting with the SETTINGS menu.
- ④ Changing the Table Type setting with the TOOLS menu.

The table below shows which data is discarded and which data is retained.

| Operation Data, Setting | ① | ② | ③ | ④ |
|--|-----------|----------|-----------|-----------|
| Number table data (x -, $f(x)$ -, $g(x)$ -columns) | Discarded | Retained | Discarded | Discarded |
| Table Range settings | Discarded | Retained | Retained | Retained |
| Table Type settings | Retained | Retained | Retained | -- |
| $f(x)$, $g(x)$ defining equations | Retained | Retained | Discarded | Retained |

Complex Number Calculations

To perform complex number calculations, first launch the Complex app. Press \odot , select the Complex app icon, and then press OK .

Inputting Complex Numbers

You can use either rectangular coordinates ($a+bi$) or polar coordinates ($r\angle\theta$) to input complex numbers.

Example 1: To input $2+3i$

$$2 \oplus 3 \uparrow \textcircled{9} (i)^* \quad \boxed{2+3i}$$

* You can also use the following operation to input i : $\textcircled{\ominus}$ – [Complex] > [i].

Example 2: To input $5\angle 30$

$$5 \textcircled{\ominus} \text{ – [Complex] > [\angle] 30} \quad \boxed{5\angle 30}$$

Complex App Calculation Examples

Before Performing the Example Operations

- For the examples in this section, use the SETTINGS menu to select MathI/MathO for the Input/Output setting. Configure other settings as shown for each example.
- Complex number calculation results are displayed in accordance with the Complex Result setting on the SETTINGS menu.
- If you are planning to perform input and display of the calculation result in polar coordinate format, specify the Angle Unit on the SETTINGS menu before starting the calculation.
- The θ value of the calculation result is displayed in the range of $-180^\circ < \theta \leq 180^\circ$.
- Display of the calculation result while something other than MathI/MathO is selected will show a and bi (or r and θ) on separate lines.

Example 3: $(1 + i)^4 + (1 - i)^2 = -4 - 2i$

(Complex Result: $a+bi$)

(1) (+) (↑) (9) (i) (>) (■) (4) (>) (+)
(1) (-) (↑) (9) (i) (>) (■) (2) (EXE)

$(1+i)^4 + (1-i)^2$
 $-4-2i$

Note

- When raising a complex number to an integer power using the syntax $(a+bi)^n$, the power value can be within the following range: $-1 \times 10^{10} < n < 1 \times 10^{10}$.

Example 4: $2\angle 45 = \sqrt{2} + \sqrt{2}i$

(Angle Unit: Degree, Complex Result: $a+bi$)

2 (⊞) - [Complex] > [∠] 45 (EXE)

$2\angle 45$
 $\sqrt{2} + \sqrt{2}i$

Example 5: $\sqrt{2} + \sqrt{2}i = 2\angle 45$

(Angle Unit: Degree, Complex Result: $r\angle\theta$)

(√) 2 (>) (+) (√) 2 (>) (↑) (9) (i) (EXE)

$\sqrt{2} + \sqrt{2}i$
 $2\angle 45$

Example 6: To obtain the conjugate complex number of $2 + 3i$

(Complex Result: $a+bi$)

(⊞) - [Complex] > [Conjugate]
2 (+) 3 (↑) (9) (i) (EXE)

$\text{Conj}(2+3i)$
 $2-3i$

Example 7: To obtain the absolute value and argument of $1 + i$

(Angle Unit: Degree)

(⊞) - [Numeric Calc] > [Absolute Value]
1 (+) (↑) (9) (i) (EXE)

$|1+i|$
 $\sqrt{2}$

(⊞) - [Complex] > [Argument]
1 (+) (↑) (9) (i) (EXE)

$\text{Arg}(1+i)$
45

Example 8: To extract the real part and imaginary part of $2 + 3i$

$\text{ReP} \left[\text{Complex} \right] > \text{[Real Part]}$
 $2 \oplus 3 \uparrow 9 (i) \ominus \text{EXE}$

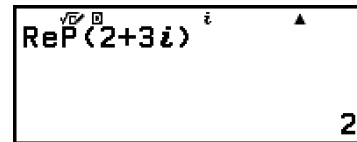

$\text{ImP} \left[\text{Complex} \right] > \text{[Imaginary Part]}$
 $2 \oplus 3 \uparrow 9 (i) \ominus \text{EXE}$

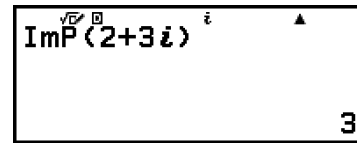

Converting a Complex Number Calculation Result to Rectangular or Polar Coordinates

You can use the FORMAT menu that appears when you press FORMAT to convert a complex number calculation result to rectangular coordinate or polar coordinate format.

Example 9: $\sqrt{2} + \sqrt{2}i = 2 \angle 45$, $2 \angle 45 = \sqrt{2} + \sqrt{2}i$
 (Angle Unit: Degree, Complex Result: $a+bi$)

$\sqrt{\square} 2 > + \sqrt{\square} 2 > \uparrow 9 (i) \ominus \text{EXE}$

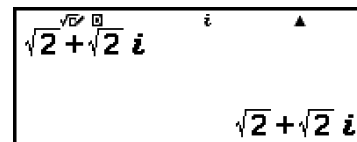

FORMAT – [Polar Coord]

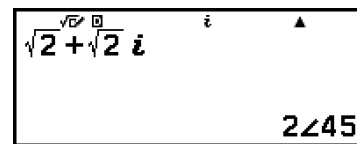

FORMAT – [Rectangular Coord]

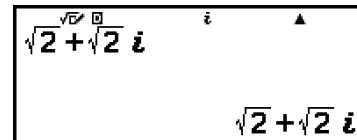

Using Verify with the Complex App

After enabling Verify in the Complex app, you can determine if an equation or inequality is true. With the Complex app, you can determine whether an equation that includes a complex number is true or false.

Note

- Verify can be used with various calculator apps. Before performing the operations in this section, first read the information in **"Verify Overview" (page 59)**.
- Whether an inequality that includes a complex number is true or false cannot be determined (Math ERROR).
- When Verify is enabled with the Complex app, the following items are the same as those for the Calculate app.
 - **"Verifiable Expressions" (page 61)**

Example Verify Operation

Example 10: To determine whether $i^2 = -1$ is true

- To enable Verify, press \odot and then select [Verify ON].
 - An \checkmark indicator appears at the top of the screen to indicate that Verify has been enabled.
- Input $i^2 = -1$ and determine if it is true.

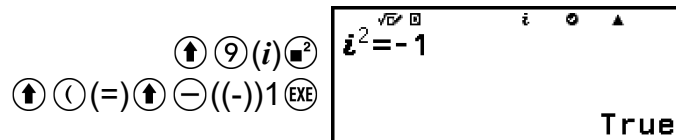

- To disable Verify and exit the Verify operation, press \odot and then select [Verify OFF].
 - This causes the \checkmark indicator to disappear from the screen.
 - For information about how to disable Verify, see ["To disable Verify" \(page 60\)](#).

Vector Calculations

Use the Vector app to perform two-dimensional and three-dimensional vector calculations.

General Procedure for Performing a Vector Calculation

To perform a vector calculation, use the special vector variables (VctA, VctB, VctC, VctD) as shown in the example below.

Example 1: To calculate $(1, 2) + (3, 4)$

- When performing addition or subtraction of two vectors, they both must have the same dimensions.
- Press \odot , select the Vector app icon, and then press OK .
 - This displays the vector calculation screen.

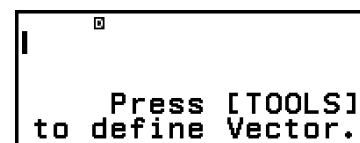

- Press \odot .
 - This displays the vector variable list screen.

```
VctA:None
VctB:None
VctC:None
VctD:None
```

- For details about the vector variable list screen contents, and how to perform vector variable store, edit, or other operations, see "[Vector Variable List Screen](#)" (page 97).
3. Perform the steps below to store (1, 2) to VctA.
- (1) Select [VctA:], and then press OK .
- This displays the vector dimension setting screen (initial default setting: 2 dimensions).

```
Vector Dimension?
Dimensions :2
Confirm
```

- (2) Here, we want to store a two-dimensional vector, so select [Confirm] and then press OK .
- This displays the Vector Editor for input of the two-dimensional vector for VctA.

```
VctA=
[ ]
0
```

- (3) Input the elements of VctA.

1 EXE 2 EXE

```
VctA=
[ 1 ]
2
```

- (4) Press S , AC , or OK to return to the vector calculation screen.

4. Perform the steps below to store (3, 4) to VctB.

- (1) Press V , select [VctB:], and then press OK .
- (2) Select [Confirm], and then press OK .
- (3) Input the elements of VctB.

3 EXE 4 EXE

```
VctB=
[ 3 ]
4
```

- (4) Press S , AC , or OK to return to the vector calculation screen.

5. Input VctA+VctB.

V - [Vector] > [VctA]
 + V - [Vector] > [VctB]

```
VctA+VctB
```

6. Press EXE .

- This displays the VctAns (Vector Answer Memory) screen with the calculation result.



- For details about VctAns, see "[Vector Answer Memory \(VctAns\)](#)" ([page 99](#)).
- Pressing AC while the VctAns screen is displayed returns to the vector calculation screen and clears the calculation expression. Pressing ↵ or OK returns to the calculation expression input complete state in step 5 of this procedure.

Note

- While the Vector Editor or the VctAns screen is displayed, you can store the currently highlighted value to a variable. While the vector calculation screen is displayed and a calculation result value is on the screen, you can store the displayed calculation result to a variable. For details about variables, see "[Variables \(A, B, C, D, E, F, x, y, z\)](#)" ([page 35](#)).

Vector Variable List Screen

The vector variable list screen is the entry portal you should use when you want to store a vector into vector variable VctA, VctB, VctC, or VctD, or to edit a previously stored vector. The status of each vector variable is indicated as shown in the examples below.

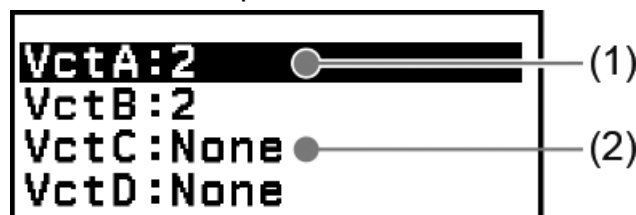

(1) 2

Indicates a two-dimensional vector is stored to the vector variable.

(2) None1

Indicates that nothing is stored to the vector variable.

Displaying the vector variable list screen

Depending on the currently displayed screen, perform one of the operations below.

- When the vector calculation screen is displayed:
Press ⏏ .

- When the Vector Editor or VctAns screen is displayed:
Press \odot , select [Define Vector], and then press OK .

Storing New Data to a Vector Variable

Example 2: To store the three-dimensional vector (1, 2, 3)

1. While the vector calculation screen is displayed, press \odot to display the vector variable list screen.
2. Select the vector variable (VctA, VctB, VctC, or VctD) to which you want to store new data, and then press OK .
 - If you selected a vector variable whose status is "None1", advance to step 4 of this procedure.
 - If you selected a vector variable that already has a vector stored to it, a menu screen will appear. Advance to step 3.



3. Select [Define New], and then press OK .
4. On the "Vector Dimension?" screen that appears, specify the vector dimension.

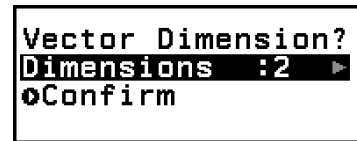

- To specify three dimensions, perform the steps below.
 - (1) Select [Dimensions] and then press OK .
 - (2) On the menu that appears, select [3 Dimensions] and then press OK .
5. After the dimension specification is the way you want, select [Confirm] and then press OK .
 - This displays the Vector Editor.



6. Input the elements of the vector variable.

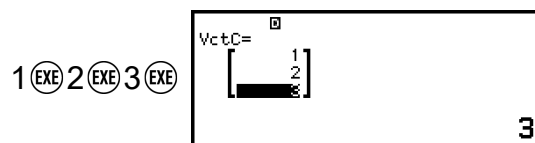

7. Press \leftarrow , AC , or OK to return to the vector calculation screen.

Note

- Vector variable contents are retained even if you press C , change the calculator app, or turn off the calculator. Executing any one of the operations below causes the contents of all vector variables to be cleared.
- C – [Reset] > [Settings & Data]
- C – [Reset] > [Initialize All]

Editing Vector Variable Data

1. While the vector calculation screen is displayed, press C to display the vector variable list screen.
2. Select the vector variable (VctA, VctB, VctC, or VctD) you want to edit, and then press OK .
3. On the menu that appears, select [Edit] and then press OK .
 - This displays the Vector Editor.
4. Use the Vector Editor to edit the elements of the vector.
 - Move the cursor to the cell that contains the element you want to change, input the new value, and then press EXE .
5. Press C , AC , or OK to return to the vector calculation screen.

Copying Vector Variable (or VctAns) Contents

1. Display the Vector Editor or VctAns screen of the vector variable you want to use as the copy source.
 - To display the Vector Editor, perform steps 1, 2, and 3 under **"Editing Vector Variable Data" (page 99)**.
 - To display the VctAns screen, perform the steps below while the vector calculation screen is displayed.
 C – [Vector] > [VctAns] EXE
2. Select the vector variable copy destination.
 - For example, to copy to VctD, perform the following operation: C – [Store] > [VctD].
 - This displays the Vector Editor with the contents of the copy destination.
3. Press C , AC , or OK to return to the vector calculation screen.

Vector Answer Memory (VctAns)

Whenever the result of a calculation executed in the Vector app is a vector, the VctAns screen will appear with the result. The result also will be stored to a variable named "VctAns".

The VctAns variable can be used in calculations as described below.

- To insert the VctAns variable into a calculation, perform the following operation: $\text{Ⓜ} - [\text{Vector}] > [\text{VctAns}]$.
- Pressing any one of the following keys while the VctAns screen is displayed switches automatically to the vector calculation screen, with "VctAns" followed by the operator or function of the key you pressed: ⊕ , ⊖ , ⊗ , ⊘ , Ⓜ , Ⓜ^{\square} , Ⓜ^2 , $\text{Ⓜ}^{\sqrt{\square}}$, $\text{Ⓜ}^{\sqrt{\square}}$, $\text{Ⓜ}^{\square^{-1}}$.

Note

- VctAns contents are retained even if you press ⏻ or turn off the calculator. Performing any one of the operations below causes the VctAns contents to be cleared.
 - Returning to the HOME screen and launching another calculator app
 - Executing $\text{Ⓜ} - [\text{Reset}] > [\text{Settings \& Data}]$
 - Executing $\text{Ⓜ} - [\text{Reset}] > [\text{Initialize All}]$

Vector Calculation Examples

The examples below use $\text{VctA} = (1, 2)$ and $\text{VctB} = (3, 4)$, and $\text{VctC} = (2, -1, 2)$.

Example 3: $\text{VctA} \cdot \text{VctB}$ (Vector dot product)

$$(a_1, a_2) \cdot (b_1, b_2) = a_1b_1 + a_2b_2$$

$$(a_1, a_2, a_3) \cdot (b_1, b_2, b_3) = a_1b_1 + a_2b_2 + a_3b_3$$

$\text{Ⓜ} - [\text{Vector}] > [\text{VctA}]$
 $\text{Ⓜ} - [\text{Vector}] > [\text{Vector Calc}] > [\text{Dot Product}]$
 $\text{Ⓜ} - [\text{Vector}] > [\text{VctB}] \text{Ⓜ}$

| | |
|-------------|----|
| VctA · VctB | 11 |
|-------------|----|

Note

- When calculating a dot product, the dimensions of the two vectors must be the same.

Example 4: $\text{VctA} \times \text{VctB}$ (Vector cross product)

$$(a_1, a_2) \times (b_1, b_2) = (0, 0, a_1b_2 - a_2b_1)$$

$$(a_1, a_2, a_3) \times (b_1, b_2, b_3)$$

$$= (a_2b_3 - a_3b_2, a_3b_1 - a_1b_3, a_1b_2 - a_2b_1)$$

$\text{Ⓜ} - [\text{Vector}] > [\text{VctA}]$
 $\text{Ⓜ} - [\text{Vector}] > [\text{Vector Calc}] > [\text{Cross Product}]$
 $\text{Ⓜ} - [\text{Vector}] > [\text{VctB}] \text{Ⓜ}$

| | |
|---------|--|
| VctAns= | $\begin{bmatrix} 0 \\ 0 \\ -2 \end{bmatrix}$ |
|---------|--|

Note

- When calculating a cross product, the dimensions of the two vectors must be the same.

Example 5: To obtain the absolute values of VctC

$$\text{Abs}(a_1, a_2) = \sqrt{a_1^2 + a_2^2}$$

$$\text{Abs}(a_1, a_2, a_3) = \sqrt{a_1^2 + a_2^2 + a_3^2}$$

[Abs] – [Numeric Calc] > [Absolute Value]

[Abs] – [Vector] > [VctC]

[)] [EXE]

| | |
|---------------------------|----------|
| $\text{Abs}(\text{VctC})$ | 3 |
|---------------------------|----------|

Technical Information

Errors

The calculator will display an error message whenever an error occurs for any reason during a calculation.

Displaying the Location of an Error

While an error message is displayed, pressing OK , ↵ , or AC returns to the screen that was displayed immediately before the error message appeared. The cursor will be positioned at the location where the error occurred, ready for input. Make the necessary corrections to the calculation and execute it again.

Example: When you input $14 \div 0 \times 2$ by mistake instead of $14 \div 10 \times 2$.

14 \div 0 \times 2 EXE

Math ERROR
Back

OK (or ↵ or AC)

14 \div 0 \times 2

\leftarrow 1 EXE

14 \div 10 \times 2
14
5

Error Messages

Syntax ERROR

Cause:

- There is a problem with the format of the calculation you are performing.

Action:

- Make necessary corrections.

Math ERROR

Cause:

- The intermediate or final result of the calculation you are performing exceeds the allowable calculation range.

- Your input exceeds the allowable input range (particularly when using functions).
- The calculation you are performing contains an illegal mathematical operation (such as division by zero).
- While using an app that does not support complex numbers or while a screen that does not accept input of complex numbers is displayed, you attempted to execute a calculation that includes a variable where a complex number is stored.
- When Verify is enabled (Verify ON) while using the Complex app, you entered an inequality that includes a complex number.

Action:

- Check the input values, reduce the number of digits, and try again.
- When using a variable as the argument of a function, make sure that the variable value is within the allowable range for the function.
- To execute a calculation that includes a variable where a complex number is stored, while using an app that does not support complex numbers or while a screen that does not accept input of complex numbers is displayed, change the value stored to the variable to a real number.
- You cannot use Verify in the Complex app to determine if an inequality that includes a complex number is true. You can determine the truth of an equation that includes a complex number.

Stack ERROR

Cause:

- The calculation you are performing has caused the capacity of the numeric stack or the command stack to be exceeded.

Action:

- Simplify the calculation expression so it does not exceed the capacity of the stack.
- Try splitting the calculation into two or more parts.

Argument ERROR

Cause:

- There is a problem with the argument of the calculation you are performing.

Action:

- Make necessary corrections.
-

Dimension ERROR (Vector app only)

Cause:

- You are trying to perform a calculation with vectors whose dimensions do not allow that type of calculation.

Action:

- Check the dimensions specified for the vectors to see if they are compatible with the calculation.
-

Range ERROR (Table app only)

Cause:

- An attempt to generate a number table in the Table app whose conditions cause it to exceed the maximum number of allowable rows.

Action:

- Narrow the table calculation range by changing the Start, End, and Step values, and try again.
-

Time Out (Distribution app only)

Cause:

- The current distribution calculation ends without the ending condition being fulfilled.

Action:

- Change the value of each parameter.
-

Circular ERROR ($f(x)$ and $g(x)$ feature only)

Cause:

- Circular reference is occurring in a registered composite function (["Registering a Composite Function" \(page 57\)](#)).

Action:

- Do not have $g(x)$ input into $f(x)$, and $f(x)$ input into $g(x)$ at the same time.
-

No Operator (Calculate and Complex apps only)

Cause:

- You entered an expression that does not include an operator and tried to determine if it is true.

Action:

- Enter an equation or inequality and then determine if it is true.

Not Defined

Cause ($f(x)$ and $g(x)$ feature):

- You attempted to calculate $f(x)$ or $g(x)$ with $f(x)/g(x)$ undefined.

Action:

- Define $f(x)$ or $g(x)$ before calculating $f(x)/g(x)$.

Cause (Vector app):

- The vector you are trying to use in a calculation was input without specifying its dimension.

Action:

- Specify the dimension of the vector and then perform the calculation again.

Before Assuming Malfunction of the Calculator...

Note that you should make separate copies of important data before performing these steps.

1. Check the calculation expression to make sure that it does not contain any errors.
2. Make sure that you are using the correct calculator app for the type of calculation you are trying to perform.
 - To check which calculator app you are currently using, press \odot . This highlights the icon of the calculator app currently in use.
3. If the above steps do not correct your problem, press the \uparrow key.
 - This causes the calculator to perform a routine that checks whether calculation functions are operating correctly. If the calculator discovers any abnormality, it automatically initializes the calculator app and clears memory contents.
4. Return the calculator settings (except for Contrast and Auto Power Off) to their initial default settings by performing the procedure below.
 - (1) Press \odot , select a calculator app icon, and then press OK .
 - (2) Press \equiv , and then select [Reset] > [Settings & Data] > [Yes].

Replacing the Battery

If the screen shown below appears right after you turn on power, it means that remaining battery power is low.

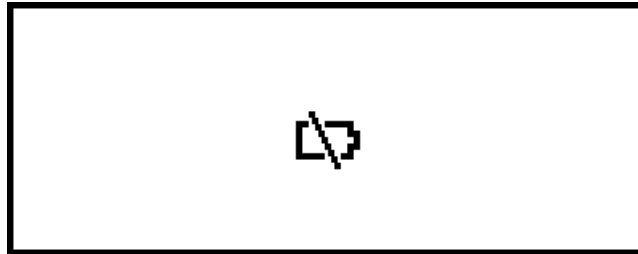

A low battery is also indicated by a dim display, even if contrast is adjusted, or by failure of figures to appear on the display immediately after you turn on the calculator.

If this happens or the above screen appears, replace the battery with a new one.

Important!

- Removing the battery causes all of the calculator's memory contents to be cleared.

1. Press \uparrow (AC) (OFF) to turn off the calculator.
 - To ensure that you do not accidentally turn on power while replacing the battery, attach the front cover to the front of the calculator.
2. As shown in the illustration, remove the battery cover, remove the battery, and then load a new battery with its plus (+) and minus (-) ends facing correctly.

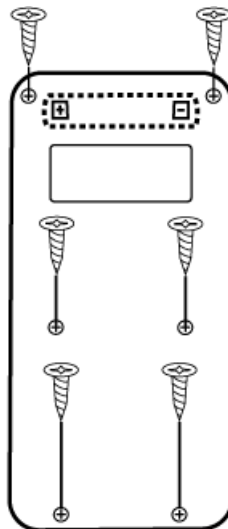

3. Replace the battery cover.
4. Press \odot to turn on the calculator.
5. Initialize the calculator.
 - (1) Press \triangle , select a calculator app icon, and then press OK .
 - (2) Press \equiv , and then select [Reset] > [Initialize All] > [Yes].
 - Do not skip the above steps!

Calculation Ranges, Number of Digits, and Precision

The calculation range, number of digits used for internal calculation, and calculation precision depend on the type of calculation you are performing.

Calculation Range and Precision

| | |
|---|---|
| Calculation Range | $\pm 1 \times 10^{-99}$ to $\pm 9.999999999 \times 10^{99}$ or 0 |
| Number of Digits for Internal Calculation | 23 digits |
| Precision | In general, ± 1 at the 10th digit for a single calculation. Precision for exponential display is ± 1 at the least significant digit. Errors are cumulative in the case of consecutive calculations. |

Function Calculation Input Ranges and Precision

| Functions | Input Range | |
|--------------------------|--|---|
| sinx cosx | Degree | $0 \leq x < 9 \times 10^9$ |
| | Radian | $0 \leq x < 157079632.7$ |
| | Gradian | $0 \leq x < 1 \times 10^{10}$ |
| tanx | Degree | Same as sinx, except when $ x = (2n - 1) \times 90$. |
| | Radian | Same as sinx, except when $ x = (2n - 1) \times \pi/2$. |
| | Gradian | Same as sinx, except when $ x = (2n - 1) \times 100$. |
| $\sin^{-1}x, \cos^{-1}x$ | $0 \leq x \leq 1$ | |
| $\tan^{-1}x$ | $0 \leq x \leq 9.999999999 \times 10^{99}$ | |
| sinhx, coshx | $0 \leq x \leq 230.2585092$ | |

| | |
|-------------------------|---|
| $\sinh^{-1}x$ | $0 \leq x \leq 4.999999999 \times 10^{99}$ |
| $\cosh^{-1}x$ | $1 \leq x \leq 4.999999999 \times 10^{99}$ |
| $\tanh x$ | $0 \leq x \leq 9.999999999 \times 10^{99}$ |
| $\tanh^{-1}x$ | $0 \leq x \leq 9.999999999 \times 10^{-1}$ |
| $\log x, \ln x$ | $0 < x \leq 9.999999999 \times 10^{99}$ |
| 10^x | $-9.999999999 \times 10^{99} \leq x \leq 99.99999999$ |
| \sqrt{x} | $0 \leq x < 1 \times 10^{100}$ |
| x^2 | $ x < 1 \times 10^{50}$ |
| x^{-1} | $ x < 1 \times 10^{100}; x \neq 0$ |
| $x!$ | $0 \leq x \leq 69$ (x is an integer) |
| nPr | $0 \leq n < 1 \times 10^{10}, 0 \leq r \leq n$ (n, r are integers) $1 \leq \{n!/(n-r)!\} < 1 \times 10^{100}$ |
| nCr | $0 \leq n < 1 \times 10^{10}, 0 \leq r \leq n$ (n, r are integers) $1 \leq n!/r! < 1 \times 10^{100}$ or $1 \leq n!/(n-r)! < 1 \times 10^{100}$ |
| $\text{Pol}(x, y)$ | $ x , y \leq 9.999999999 \times 10^{99}$ $\sqrt{x^2 + y^2} \leq 9.999999999 \times 10^{99}$ |
| $\text{Rec}(r, \theta)$ | $0 \leq r \leq 9.999999999 \times 10^{99}$ θ : Same as $\sin x$ |
| $a^\circ b'c''$ | $ a , b, c < 1 \times 10^{100}; 0 \leq b, c$ The display seconds value is subject to an error of ± 1 at the second decimal place. |
| $a^\circ b'c'' = x$ | $0^\circ 0' 0'' \leq x \leq 99999999^\circ 59' 59''$ A sexagesimal value outside of the above range is automatically treated as a decimal value. |
| x^y | $x > 0: -1 \times 10^{100} < y \log x < 100$ $x = 0: y > 0$ $x < 0: y = n, \frac{m}{2n+1}$ (m, n are integers) However: $-1 \times 10^{100} < y \log x < 100$ |

| | |
|---------------|---|
| $\sqrt[x]{y}$ | $y > 0: x \neq 0, -1 \times 10^{100} < 1/x \log y < 100$ $y = 0: x > 0$ $y < 0: x = 2n + 1, \frac{2n + 1}{m} (m \neq 0; m, n \text{ are integers})$ However: $-1 \times 10^{100} < 1/x \log y < 100$ |
| $a^{b/c}$ | Total of integer, numerator, and denominator must be 10 digits or less (including separator symbol). |
| RanInt#(a, b) | $a < b; a , b < 1 \times 10^{10}; b - a < 1 \times 10^{10}$ |
| GCD(a, b) | $ a , b < 1 \times 10^{10} (a, b \text{ are integers})$ |
| LCM(a, b) | $0 \leq a, b < 1 \times 10^{10} (a, b \text{ are integers})$ |

- Precision is basically the same as that described under "Calculation Range and Precision", above.
- $x^y, \sqrt[x]{y}, x!, nPr, nCr$ type functions require consecutive internal calculation, which can cause accumulation of errors that occur with each calculation.
- Error is cumulative and tends to be large in the vicinity of a function's singular point and inflection point.
- The range for calculation results that can be displayed in π form when MathI/MathO is selected for Input/Output on the SETTINGS menu is $|x| < 10^6$. Note, however, that internal calculation error can make it impossible to display some calculation results in π form. It also can cause calculation results that should be in decimal form to appear in π form.

Specifications

Power Requirements:

AAA-size battery R03 \times 1

Approximate Battery Life:

2 years (based on one hour of operation per day)

Power Consumption:

0.0008 W

Operating Temperature:

0°C to 40°C (32°F to 104°F)

Dimensions:

13.8 (H) × 77 (W) × 162 (D) mm

$\frac{9}{16}$ " (H) × $3\frac{1}{16}$ " (W) × $6\frac{3}{8}$ " (D)

Approximate Weight:

100 g (3.5 oz) including the battery

Frequently Asked Questions

Frequently Asked Questions

■ How can I change a fraction form result produced by a division operation to decimal form?

→ While a fraction calculation result is displayed, press FORMAT and then select [Decimal], or press $\uparrow \text{EXE} (\approx)$. To have calculation results initially appear as decimal values, change the Input/Output setting on the SETTINGS menu to MathI/DecimalO.

■ What is the difference between Ans memory, PreAns memory, and variable memory?

→ Each of these types of memory acts like "containers" for temporary storage of a single value.

Ans Memory: Stores the result of the last calculation performed. Use this memory to carry the result of one calculation on to the next.

PreAns Memory: Stores the result of calculation before the last one. PreAns memory can be used only in the Calculate app.

Variables: This memory is helpful when you need to use the same value multiple times in one or more calculations.

■ How can I find a function I was using with an older CASIO calculator model on this calculator?

→ This calculator's functions can be accessed from the CATALOG menu that appears when you press CATALOG . For details, see the sections below.

["Using the CATALOG Menu" \(page 23\)](#)

["Advanced Calculations" \(page 46\)](#)

■ With an older CASIO calculator model, I pressed $\text{S}\leftrightarrow\text{D}$ to change the calculation result display format. What should I do with this calculator?

→ While a calculation result is displayed, press FORMAT . Use the menu that appears to select the display format you want. For details, see ["Changing Calculation Result Format" \(page 38\)](#).

■ How can I find out which calculator app I am currently using?

→ Press HOME . This causes the icon of the calculator app you are currently using to become highlighted.

■ How do I calculate $\sin^2 x$

→ For example, to calculate $\sin^2 30 = \frac{1}{4}$, enter the calculation below.



■ **Why can't I input i or calculate a complex number?**

→ You cannot use the Calculate app to input i or to perform complex number calculations. Use the Complex app for such calculations.

■ **Why doesn't the Verify indicator (✓) disappear?**

→ To make the ✓ indicator that appears while Verify is enabled (Verify ON) disappear, perform the following operation: $\infty - [\text{Verify OFF}]$.
For more information about Verify, see ["Using Verify" \(page 59\)](#).

■ **Why does the battery icon (🔋) appear right after the calculator is turned on?**

→ The battery icon indicates that battery power is low. If you see this icon, replace the battery as soon as possible. For details about battery replacement, see ["Replacing the Battery" \(page 105\)](#).

■ **How can I return the calculator to its initial default settings?**

→ Perform the procedure below to initialize calculator settings (except for Contrast and Auto Power Off).

(1) Press \triangle , select a calculator app icon, and then press OK .

(2) Press \equiv , and then select [Reset] > [Settings & Data] > [Yes].

CASIO®

SA2211-A

© 2022 CASIO COMPUTER CO., LTD.