

Thank you for purchasing this CASIO product.

- Be sure to keep all user documentation handy for future reference.
- Read the "Safety Precautions" before using this product to ensure that you use it correctly.

## Read this first!

- The contents of this manual are subject to change without notice.
- The contents of this manual have been checked at each step of the production process. Feel free to contact us if you notice anything that is questionable, erroneous, etc.
- Any copying of the contents of this manual, either in part or its entirety, is forbidden. Except for your own personal use, any other use of the contents of this manual without the permission of CASIO COMPUTER CO., LTD. is forbidden under copyright laws.
- CASIO COMPUTER CO., LTD. shall not be held liable for any damages or lost profits suffered by you or any third party due to the use or malfunction of this product.
- CASIO COMPUTER CO., LTD. shall not be held liable for any damages or lost profits caused by loss of memory contents due to malfunction, repair, or any other reason.
- Note that the example screens and product illustrations shown in this manual may differ somewhat from the screens and configuration of the actual camera.

**LCD Panel**  
The liquid crystal panel of the monitor screen uses high-precision technology that provides a pixel yield in excess of 99.99%. This means that some very small number of pixels may not light or may remain lit at all times. This is due to the characteristics of the liquid crystal panel, and does not indicate malfunction.

**Take test shots**  
Before shooting your final image, shoot a test shot to ensure that the camera is recording correctly.

## Accessories

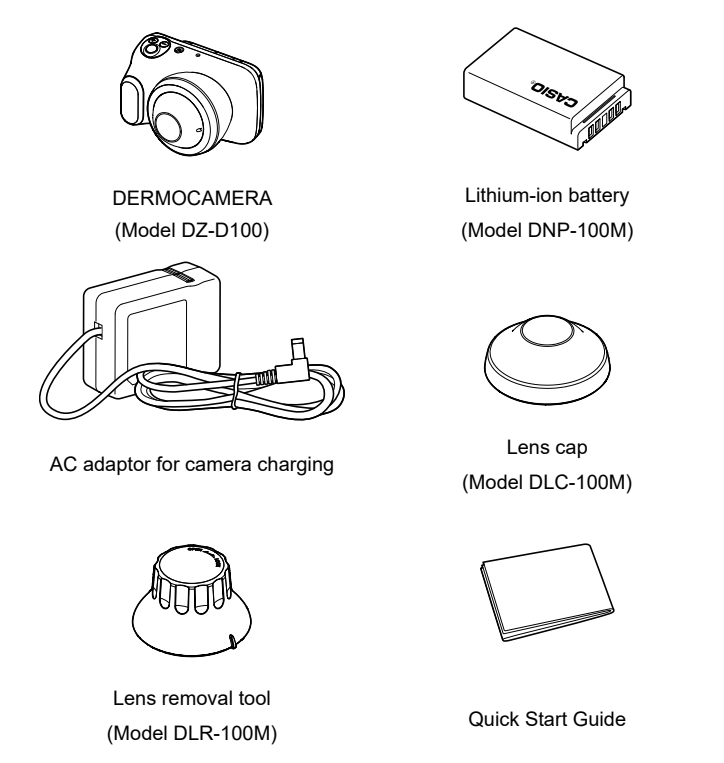

## Component names

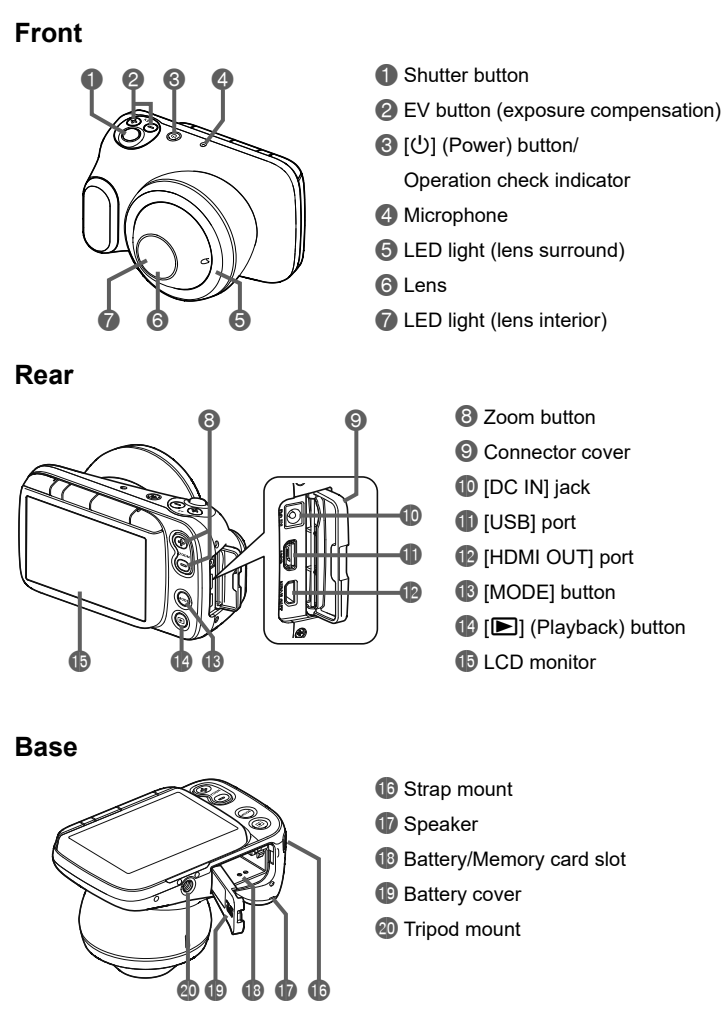

## Inserting the battery and memory card

### Supported Memory Cards

- Your camera has built-in memory that you can use to store a number of still images and short videos. If you want to store more images, use a third-party SD memory card.
- SD Memory Card (Up to 2GB)
  - SDHC Memory Card (2GB to 32GB)
  - SDXC Memory Card (32GB to 2TB)
- The above are supported memory card types as of March 2019.
- Values in parentheses are specification values.
  - Note that the ability to use any particular card with this camera, even if it satisfies the above capacity and type requirements, is not guaranteed.

### Insert the battery and memory card

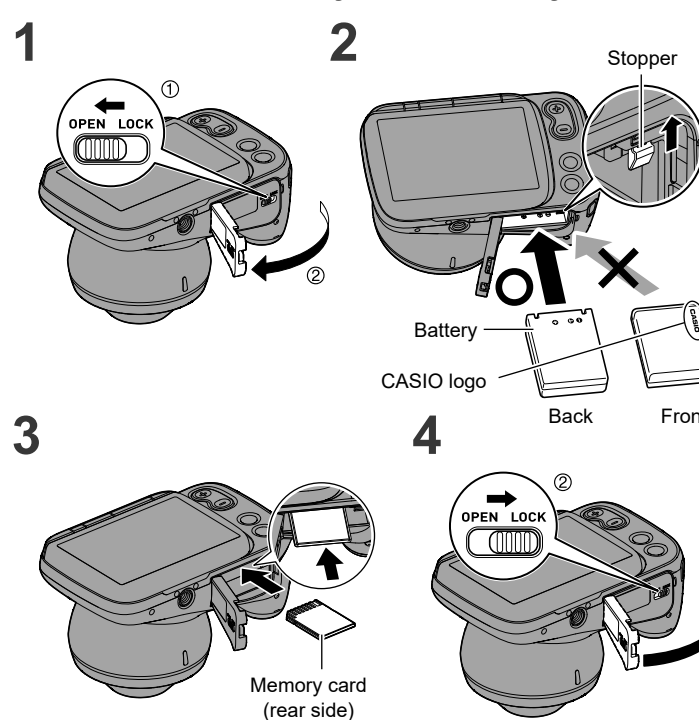

## Charging the battery

### Charging using the AC adaptor for camera charging

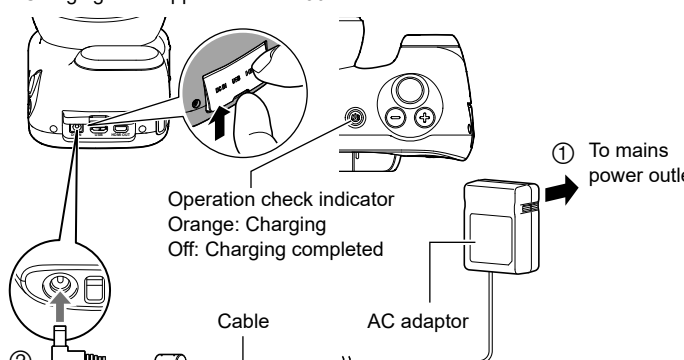
- This method charges the battery while it is in the camera.
  - With the camera switched off, connect the cable in the sequence shown in ① and ②.
- Charging time: Approx. 4 hours 30 minutes
- 
- Connect the AC adaptor to a mains power outlet.
  - Connect the camera cable to the AC adaptor.
- Operation check indicator:  
Orange: Charging  
Off: Charging completed
- When disconnecting the adaptor from the camera, always disconnect the camera end of the cable (② in the above diagram) first.

## Switching the camera on

### 1 Press [P] (Power) to switch the camera on.

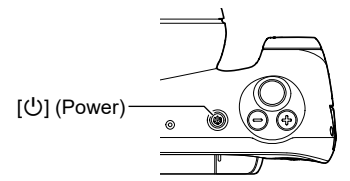

## Setting the display language, date & time

When you switch the camera on for the first time, the screen for setting the display language, date & time appears. Use the procedure below to specify the settings.

- Switch the camera on.
- Set the display language.
  - Select the language to be displayed in the screens and tap [OK].
  - The explanations in this Guide are with the display language set to "English".
- Set the date & time.
  - Tap the year, month, day, hour, minute or am (or pm)/24h and then swipe up or down to change the setting.
- Tap [OK] to finish the settings.

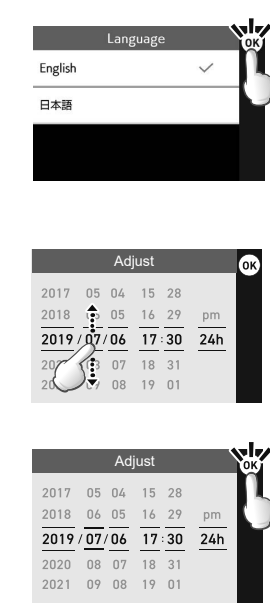

## Photographing the affected area

### 1 Switch the camera on.

- The camera starts up in recording mode.
- If the camera is in playback mode, press [P] (Playback) or the shutter button.

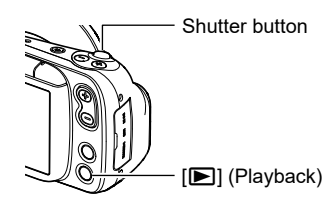

### IMPORTANT!

- If the camera does not start up, the battery may be loaded the wrong way round. The other possibility is that the battery is fully depleted. If so, recharge the battery. Refer to "Insert the battery and memory card" or "Charging the battery" for details.
- If the lens operates unexpectedly, an error screen appears and the camera shuts down. If the camera will not restart when switched on again, reload the battery and switch the camera on again.

### 2 Press [MODE] and select the recording mode.

This camera features 7 recording modes. Press [MODE] to switch between modes.

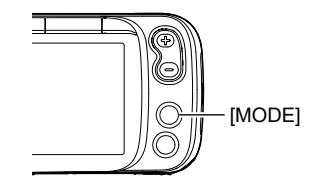

<b>NORMAL</b>	Use this mode to take a normal photograph of the affected area and its periphery.
<b>DERMO CONT</b>	Use this mode to take polarized, non-polarized and UV* close-up shots with the same angle of view with a single shutter release. * A safe light wavelength of 405 nm is used. When UV is enabled, the shot is taken with UV light. Refer to the User's Guide for more information on configuring the settings.
<b>DERMO</b>	Use this mode to take a close-up shot of the affected area.
<b>DERMO AIF</b>	Use this mode to take a close-up shot of a raised affected area so that the entire area is in focus. A single shutter release takes multiple images with a shifting focal point and the images are then merged into a single shot.
<b>NORMAL</b>	Use this mode to shoot a video of the affected area and its periphery.
<b>DERMO</b>	Use this mode to take a close-up video of the affected area.
<b>MICROSCOPE</b>	Use this mode to photograph subjects such as pathological tissue as seen through a microscope. Photography in this mode requires the optional DMS-100M microscope adaptor. Refer to the User's Guide for more information on using this mode.

### 3 Point the camera at the subject to be photographed or place the lens directly onto the affected area.

- When pointing the camera at the subject
- When placing the lens directly onto the affected area

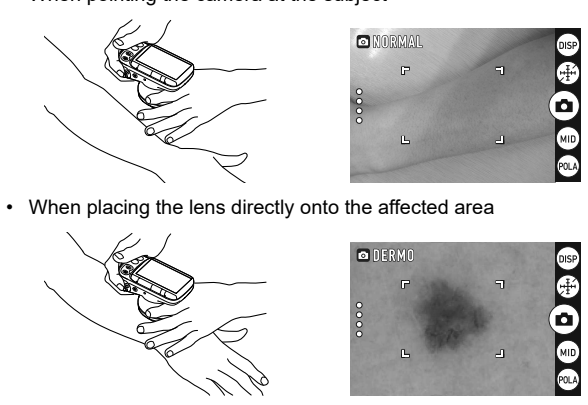

### IMPORTANT!

- Check that the lens surface is clean before taking the shot. Any soiling on the lens should be wiped off with a soft cloth, etc.

### 4 Press the shutter button halfway.

When the image is focused, the focusing frame turns green.

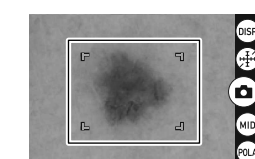

### 5 With the camera fixed in place, press the shutter button down fully.

- The photographed image is saved.
- Tapping [P] enables you to also take photos.

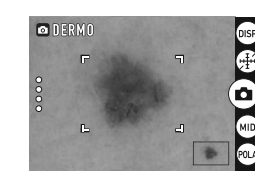

## Playing back images

- Switch the camera on.
- Press [P] (Playback).  
The camera switches to playback mode.
- Swipe left or right to move back and forth between images.
  - You can also move between images using [EV+] and [EV-].
  - To play back video, open the video file and tap [P] in the center of the screen.

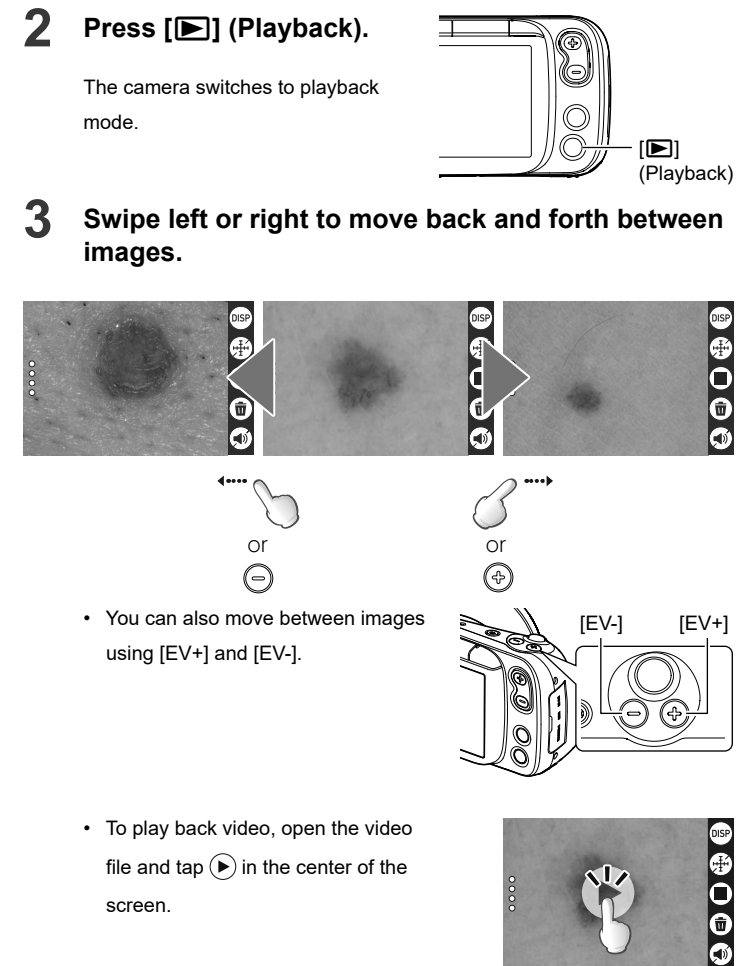

## Erasing images

- Switch the camera on.
- Press [P] (Playback).  
The camera switches to playback mode.
- Swipe left or right to select the image to be erased.
  - You can also select images using [EV+] and [EV-].
- Tap [E] (Erase).  
The selected image is erased.

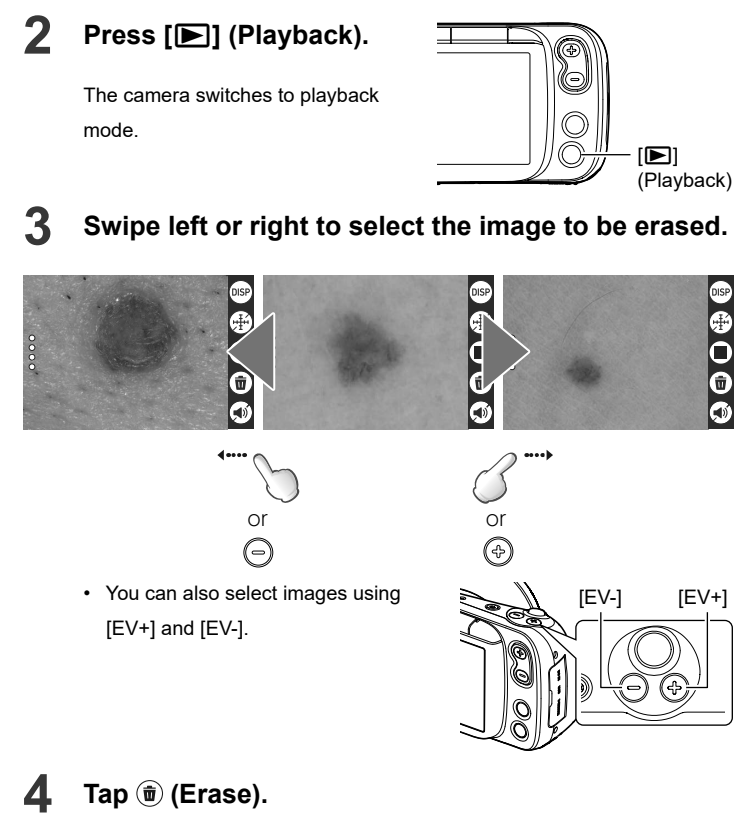

- To return to the playback screen, tap [H].
- Press [P] (Playback) or press the shutter button to return to the photography screen.

## Using the Image Management Software



You can transfer your images to your computer using the camera's Wi-Fi function and the "Dz IMAGE Viewer" image management software.

- Install the image management software on your computer.
  - Double-click the installer for the downloaded "Dz IMAGE Viewer" software. Follow the on-screen instructions to install the software.
- Enable the camera's Wi-Fi function.
  - Tap [Wi-Fi] (recall) on the left side of screen.
  - Tap [ON] and enable the Wi-Fi function.
  - Tap [OK] to display the photography information.
  - Check that the Wi-Fi function is enabled.
  - The Wi-Fi function has two modes: AP and STATION. Refer to the User's Guide for information on setting the mode.

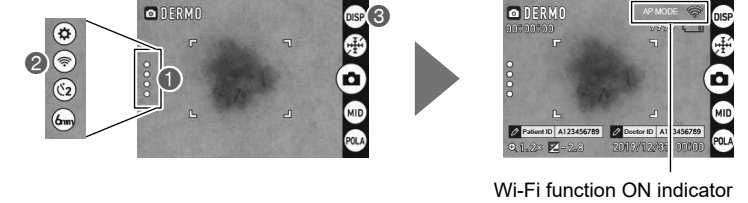

Wi-Fi function ON indicator

### 3 Enable Wi-Fi connections on your computer.

- The screens vary depending on your OS version and your computer settings. The example given here shows the procedure starting from the Windows 10 (64bit) desktop screen.
- From **Start** on the Windows desktop screen, click "Settings".

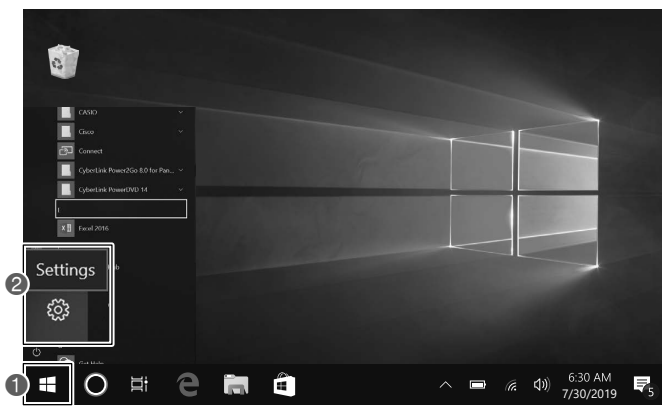

- Click "Network & Internet".

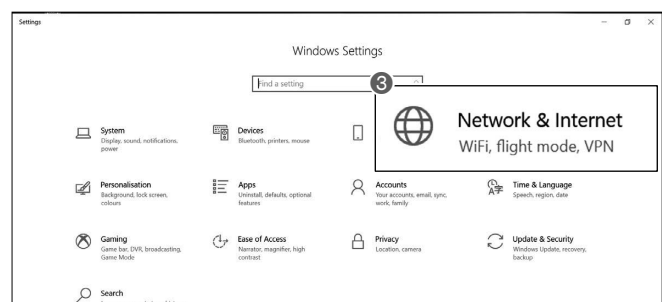

- Click "Wi-Fi" and check that the Wi-Fi setting is enabled.
- Click "Show available networks".



Select the camera's SSID.

SSID: DZ-D100

Password: 00000000

To protect personal information, it is recommended that you change the password. Refer to the User's Guide for information on changing the password.



### 4 Transfer your images to "D'z IMAGE Viewer".

Double-click the **D'z IMAGE Viewer** icon on the computer screen.

In the startup screen, click "Auto Transfer OFF".



When "Auto Transfer OFF" changes to "Transferring...", image transferring begins. The photographed images are saved in "D'z IMAGE Viewer".



## Other ways to transfer images

- You can transfer the images on the camera to your computer using a memory card or USB cable.
- Refer to the User's Guide for information on how to transfer images using a memory card or USB cable connection.

## Safety Precautions

Thank you for purchasing this CASIO product.

- Be sure to read these "Safety Precautions" before trying to use it. After reading the User's Guide, keep it in a safe place for future reference.

	<b>DANGER</b>	Indicates something that creates a major risk of death or serious personal injury.
	<b>WARNING</b>	Indicates something that creates a risk of death or serious personal injury.
	<b>CAUTION</b>	Indicates something that creates a risk of minor personal injury or physical damage.

### Symbol Examples

This circle with a line through it (⊘) means that the indicated action must not be performed. Indications within or nearby this symbol are specifically prohibited. (The example at left indicates that disassembly is prohibited.)

The black dot (●) means that the indicated action must be performed. Indications within this symbol are actions that are specifically instructed to be performed. (The example at left indicates that the power plug must be unplugged from the electrical socket.)

### DANGER

#### Rechargeable Battery Precautions

- Charge a battery using only the method specifically described in user documentation.**  
Use of another method creates the risk of battery overheating, fire, and rupture.
- Do not allow a battery to come into contact with fresh water, salt water, or other moisture. Do not use a battery that is wet.**  
Doing so creates the risk of battery overheating, fire, and rupture.
- Use only the specified type of equipment.**  
Use of the wrong equipment creates the risk of battery overheating, fire, and rupture.
- Observe the precautions below in order to avoid battery overheating, fire, and rupture.**
  - Always use only the specified type of battery.
  - Do not expose a battery to fire or heat.
  - Load a battery with its poles (plus (+) and minus (-) facing correctly.**
  - Do not carry or store a battery together with necklaces, coins, or other metal objects.
  - Do not try to disassemble or modify a battery, pierce it with a needle, subject it to strong impact (by stepping on it etc.), or apply solder directly to it.
  - Do not put a battery into a microwave oven, dryer, high-pressure vessel, etc.
  - Do not peel the external decorative sticker from a battery.
- Immediately after noticing any fluid leak, abnormal odor, overheating, discoloration, deformation or other battery abnormality, very carefully remove the battery from the product and/or charger. Keep the removed battery away from fire. Do not use a battery exhibiting any abnormality.**  
Continued use creates the risk of battery overheating, fire, and rupture.
- Do not use or leave a battery in a location exposed to direct sunlight, in an automobile parked outside, near open flame, a stove, or in any location subjected to high heat.**  
Such conditions create the risk of battery overheating, fire, and rupture. They also can cause a battery swell, making it impossible to remove.
- Should fluid from a battery get on your skin or clothing, immediately rinse it off with clean water.**  
Fluid creates the risk of skin irritation. Battery fluid getting into the eyes creates the risk of eyesight loss, etc. Immediately rinse the eyes and then contact a physician.

### WARNING

#### AC Adaptor

- Observe the precautions below in order to avoid AC adaptor fire and electric shock.**
  - Use only the specified type of AC adaptor.
  - Use only the included power cord.
  - Use the AC adaptor only with the device specified for it.
  - Do not plug the power cord into an outlet with the wrong voltage rating.
  - Do not plug into an overloaded extension cord or power outlet.
  - Do not cover the power cord with a blanket or other material during use, and keep it away from heating devices.
  - Do not place heavy objects on the power cord and do not leave it bundled during use.
  - Do not place heavy objects on the power cord and do not bundle it with cables.
  - Do not subject a power cord to heat or attempt to modify it, and avoid damaging it.
  - Do not subject the power cord to excessive bending, twisting, or pulling.
- Do not touch the plug with wet hands.**  
Doing so creates the risk of electric shock.
- If the AC adaptor or power cord becomes damaged, contact your original retailer.**  
Continued use creates the risk of fire and electric shock.  
**Do not use the AC adaptor while it is wet.\***  
**\* Avoid water, sports drinks, seawater, animal or pet urine, and other liquid.**  
Liquid creates the risk of fire and electric shock.  
**Do not place a flower vase or any other liquid container on top of the AC adaptor or power cord.**  
Water creates the risk of fire and electric shock.
- Before leaving the product unattended, unplug the AC adaptor from the power outlet, and move the product to a location away from animals and pets.**  
Pet chewing or urine can cause shorting, which creates the risk of fire.
- If thunder and lightning have begun, do not touch any equipment that is plugged into a mains power socket.**  
Doing so can result in an electric shock.

#### Storage and Operation Locations

- Do not store or use the product in any of the locations described below.**  
Doing so creates the risk of fire and electric shock.
  - Areas subjected to large amounts of moisture and dust
  - Food preparation areas, near a humidifier, or in areas where the product is exposed to oil smoke or water vapor
  - Near a heating device, on an electric carpet, in a location exposed to direct sunlight, in a car parked outside, or any other area where the product is subjected to high temperatures.
- Do not place the product on an unsteady platform, on a high shelf, or in any other unstable location.**  
Dropping and tipping over creates the risk of personal injury.

#### Abnormalities (Smoke, Odor, Heat Generation, etc.)

- Do not use the product if it is emitting smoke, odor, heat, or exhibiting any other abnormality. Do not use the product after it has been dropped or otherwise damaged.**  
Doing so creates the risk of fire and electric shock. Immediately perform the steps below.
  - Turn off power.
  - If you are using an AC adaptor, unplug its power plug from the power outlet.
  - Contact your original retailer.

#### Display Screen

- Do not press the LCD or subject it to strong impact.**  
Doing so can cause the LCD glass to crack, creating the risk of personal injury.
- Should the LCD become cracked, never touch any of the liquid inside.**  
LCD liquid getting on the skin creates the risk of skin irritation. Should LCD liquid get into your mouth, immediately rinse your mouth out and contact your physician. Should LCD liquid get in your eyes or on your skin, rinse with clean water and then contact your physician.

#### Disassembly and Modification

- Do not attempt any disassembly or modification.**  
For any internal inspection, adjustment, or repair, contact your original retailer.  
Doing so creates the risk of electric shock, burn injury, and personal injury.

#### Avoiding Water and Foreign Matter

- Do not allow water, other liquids (sports drinks, seawater, animal or pet urine, etc.), or foreign objects (metal fragments, etc.) to get into the product or the AC adaptor. Should any such matter get into the product, immediately perform the steps below.**  
Continued use creates the risk of fire and electric shock. Particular care is required when using the product when it is raining or snowing, near the ocean or other body of water, or in a bathroom.
  - Turn off power.
  - If you are using the AC adaptor to power the product, unplug the power plug from the power outlet or remove the battery from the camera.
  - Contact your original retailer.
- Do not locate a flower vase or other liquid container on top of or next to the product or AC adaptor.**  
Liquid spilling from a container creates the risk of fire and electric shock.

#### Memory Cards

- Store memory cards out of the reach of small children.**  
Should a card be swallowed accidentally, immediately contact a physician.

#### Precautions During Camera Operation

- Do not maintain contact with the camera for long periods while it is operating.**  
The product becomes warm when on, and creates the risk of low-temperature burns.

### WARNING

#### Effect on Other Electronic Devices

- Should you notice radio interference or other problems on other devices is being caused while using this product, do not use the wireless function.**  
Use of wireless functions creates the risk of radio interference and abnormal operation of other devices.
- When traveling on an aircraft, comply with the airline company's instructions.**  
**Do not use in locations where the use of this device is prohibited.**  
Electromagnetic waves and other emissions from this camera could affect instrumentation and cause an accident.
- Do not use the product in the vicinity of high-precision electronic equipment or any electronic equipment that handles weak signals.**  
Doing so can cause misoperation and other problems in the electronic equipment, and creates the risk of accident.
- Keep this product away from the chest area of any individual fitted with a cardiac pacemaker.**  
Cardiac pacemakers and similar devices can be affected by electromagnetic waves.
- Turn off the wireless function and the product while on a train or in any other crowded location.**  
When near a person wearing a cardiac pacemaker or other medical devices, radio waves may affect such devices and cause them to malfunction, creating the risk of accident.

### CAUTION

#### Rechargeable Battery Precautions

- If a battery is not charged even if the specified charging time is exceeded, stop charging.**  
Failure to do so creates the risk of battery overheating, fire, and rupture.
- Keep batteries away from children.**  
**When using a rechargeable battery, keep it away from children when it is removed from the charger and/or product.**
- Do not leave a battery near areas used by pets.**  
Pets chewing on a battery creates the risk of fluid leaking, overheating, fire, and rupture.
- Do not use a battery that is severely swollen.**  
Doing so may make it impossible to remove the battery from the product. If this happens, contact your original retailer.

#### AC Adaptor

- Observe the precautions below in order to avoid AC adaptor fire and electric shock.**
  - Do not cover the power cord with a blanket or other material during use, and keep it away from heating devices.
  - Insert the power plug into the outlet as far as it will go.
- After use, unplug the power plug from the power outlet.**
  - When unplugging the power plug, do not pull on the power cord. Grasp the plug.
  - If you do not plan to use the product for a long time, unplug from the power outlet.
- At least once a year, unplug the power plug from the power outlet and use a dry cloth to wipe away any dust buildup from the area between the prongs of the plug.**
- Do not use detergent when cleaning the power cord, especially the power plug and jack parts.**

#### User Maintenance

- Before cleaning the product, turn off power and unplug the AC adaptor from the power outlet.**  
Failure to do so creates the risk of electric shock. Leaving the AC adaptor plugged in creates the risk of damage to the power cord, fire, and electric shock.

#### Connections

- Connect only specified devices and items to connectors.**  
Connecting to other devices and items creates the risk of fire and electric shock.

#### Backing Up Important Data

- Always keep backup copies of important data by transferring it to a computer or other storage device.**  
Note that data can be deleted in the case of product malfunction, repair, etc.

#### Memory Protection

- Follow proper procedures as explained in the user documentation when replacing the memory card or battery.**  
Failure to do so creates the risk of data loss or corruption.

#### LED and Other Light Emitting Functions

- Do not fire the LED light or other light emitting functions while pointed in the direction of and too close to a person's face.**  
Doing so creates the risk of reduced vision. In the case of young children in particular, keep at least one meter away from the eyes.
- Take care that your fingers, gloves, or other items are not touching the LED light window.**  
Touching the LED light window can lead to burn injury, smoke, discoloration, or malfunction.
- Do not fire the LED light while the LED light window is dirty, dusty, or soiled with foreign matter.**  
Doing so can lead to smoke emission and discoloration.

## Notes on Handling the Camera

This camera is a precision device. Applying undue force to the lens in particular can cause damage or a fault. Take special note of the following:

- When taking photos, take care not to hit the lens against other objects, drop the camera or otherwise subject the camera to strong impacts.
- Do not use the camera in ways that subject the lens to excessive force, such as holding the camera by the lens when taking photos.
- When carrying the camera in a bag or other container, avoid subjecting the camera to excessive force. Take particular care to protect the lens, such as by fitting the lens cap provided.
- Hold on to the strap when taking pictures to avoid dropping the camera.
- Do not drop the camera or otherwise subject it to strong impacts.

#### Even during the warranty period, charges will apply to any repairs for faults caused by damage to camera components such as the lens, LCD monitor or internal circuit boards where that damage arises from handling errors, such as external pressure, impacts or being dropped.

## Notes on Using the Camera

### Operating Environment

- Operating Temperature Requirements: 10 to 30°C (50 to 86°F)
- Operating Humidity: 10 to 85% (non-condensing)
- Do not place the camera in any of the following locations.
  - In an area exposed to direct sunlight, or large amounts of moisture, dust, or sand
  - Near heating or cooling devices, or in other areas subjected to extreme changes in temperature or humidity
  - Inside of a motor vehicle on a hot day, or in an area subjected to strong vibration

## Precautions During Wireless Function (Wireless LAN, Bluetooth Wireless Technology) Use

- Operation of this product may affect or may be affected by nearby devices that use wireless functionality.
- This product is subject to the Export Administration Regulations (EAR) of the United States, and so it cannot be exported to or brought into countries that fall under U.S. Embargoes and Other Special Controls.

### Radio transmission interception

The radio waves that are used to send and receive data can be intercepted by third parties.

### Unauthorized access

CASIO COMPUTER CO., LTD. shall be held in no way liable for any unauthorized access and/or use of the access point equipped on this product if the product is ever lost or stolen.

### Use as a wireless device

Use the wireless functions of this product only as specifically described in this manual. Any other use is unintended use, and CASIO COMPUTER CO., LTD. shall be held in no way liable for any damages arising out of unintended use.

### Magnetism, electrostatic charge, and radio interference

Do not use this product near a microwave oven or any other area where magnetism, electrostatic charge, or radio interference is generated. Radio wave reception may be poor in certain environments.

Also note that other devices using the same 2.4GHz band used by this product may cause reduced processing speeds in both devices.

### Avoid proximity to magnetic cards

Do not place magnetically charged items, such as credit cards, cash cards or prepaid cards close to the terminals of this device. Doing so could make the item unusable.

### Connection to a public LAN

This product does not support wireless LAN connection over a public wireless LAN environment.

### Intended Area of Use

Use of this camera in a country or area other than where it was originally purchased runs the risk of being in violation of local radio laws and other laws. Note that CASIO COMPUTER CO., LTD. shall not be held in any way liable for any such violations.

### Making your battery last longer

This camera is equipped with Sleep and Auto Power Off functions reduce its power consumption.

- If the camera is not used for approximately 1 minute in recording mode, it switches to Sleep mode and the LCD monitor and LED light switch off. Pressing any button will wake the camera from Sleep mode.
- If the camera is not operated in any way for approximately 5 minutes while in use, it automatically shuts down (Auto Power Off function).

## Troubleshooting

### I can't charge the camera.

- Connect or disconnect the cable for the AC adaptor for camera charging.
- Briefly remove the battery from the camera and then reload the battery.

### The camera won't switch on.

- Check that the battery is loaded into the camera.
- The battery may be fully discharged. If so, recharge the battery. ("Charging the battery" in this Guide) If the battery immediately runs flat after charging, the battery has reached the end of its service life. Purchase a new lithium-ion battery (DNP-100M) (sold separately).

### I can't turn off the camera, and none of the buttons work.

- Briefly remove the battery from the camera and then reload the battery.

### The camera switched itself off for no reason.

- The Auto Power Off function may have been triggered. Turn the camera back on.
- The battery may be fully discharged. If so, recharge the battery.

### I can't get the image in focus.

- The lens may be dirty. Wipe the lens clean and try focusing the image again.
- If you shoot the image without pressing the shutter button halfway first, the image may not be in focus. Make sure that you press the shutter button down halfway to get the image in focus.
- The recording mode setting may not be suitable for the photographed site. Use the [MODE] button to switch to a suitable recording mode ("Photographing the affected area" in this Guide).

### I can't connect to the "D'z IMAGE Viewer" image management software.

- Check that the Wi-Fi function on the camera is enabled ("Using the Image Management Software" in this Guide).
- The mode setting may be different. Refer to the User's Guide for information on setting the Wi-Fi function mode.

### There is dust or dirt inside the lens.

- Use the lens removal tool provided to detach the lens and then remove any dust or dirt. Refer to the User's Guide for more information on using the lens removal tool. Note that you should only remove the lens when absolutely necessary, as doing so can result in dust or dirt getting into the lens.