

Privia

EN

# PX-5S

## USER'S GUIDE (Tutorial)

- Before using this Digital Piano for the first time, be sure to read the separate USER'S GUIDE (Basics) to familiarize yourself with basic operations.

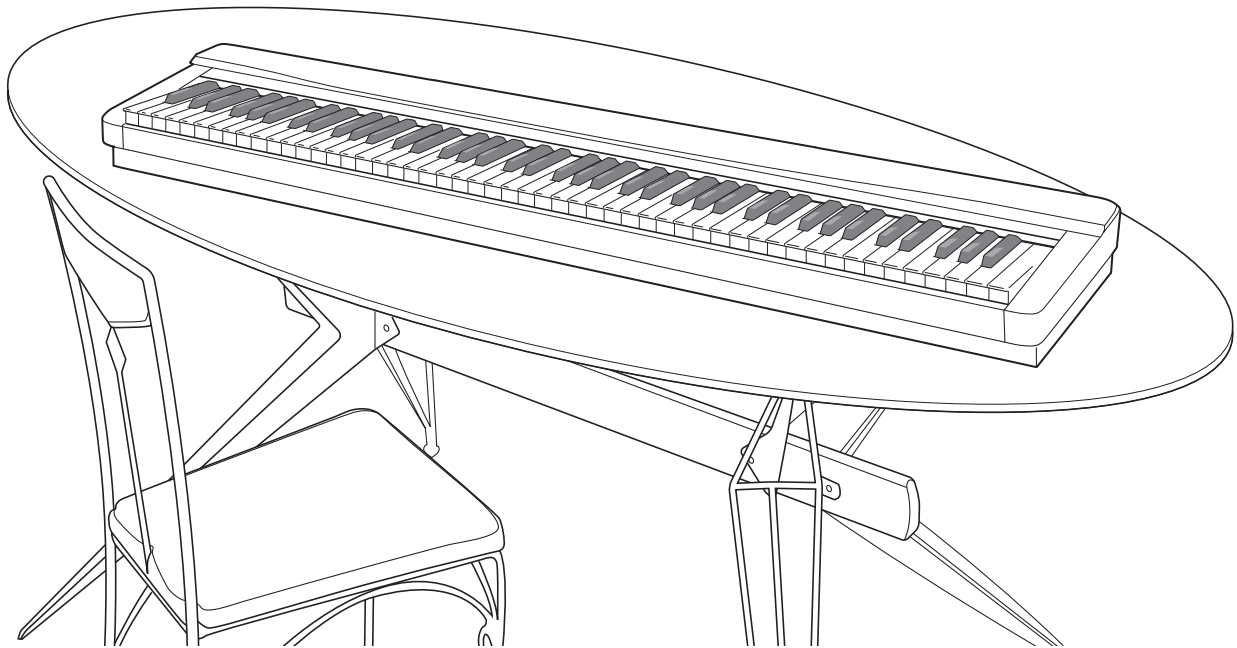



# Contents

## **General Guide..... E-2**

- Read the Separate USER'S GUIDE (Basics) ! ..... E-4
- Power On Precaution!..... E-4
- “WriteError” Message ..... E-4
- Zone, Part, MIDI Receive Channel, and Tone Relationships ..... E-5
- Controlling Sounds ..... E-8

## **Operations Common to All Modes (Tutorial)..... E-9**

- Using the Knobs for Input ..... E-9

## **Using Built-in Tones (Tutorial)..... E-10**

- To edit a tone ..... E-10
- To change the name of a tone ..... E-10
- Applying Effects to Notes ..... E-18

## **Sounding Arpeggios Automatically (Tutorial) ..... E-24**

- To play a recorded phrase as an arpeggio ..... E-24
- To select a different arpeggio for each zone ..... E-25
- To turn the arpeggio for a specific zone on or off ..... E-25
- Editing an Arpeggio ..... E-25
- Clearing Arpeggio Step Data ..... E-28
- Renaming an Arpeggio ..... E-28

## **Recording and Playing Back Phrases (Tutorial)..... E-29**

- Recording with the Phrase Sequencer ..... E-29
- Mixer Settings When Playing Back a Song ..... E-29
- To change the tempo when playing back a song ..... E-30
- To clear a track or initialize a song ..... E-30

## **Using the Stage Setups (Tutorial)..... E-31**

- To edit a stage setup ..... E-31

## **Other Useful Functions (Tutorial)..... E-36**

- System Settings ..... E-36
- Using the Mixer ..... E-36
- Adjusting the Touch Sensitivity ..... E-38
- Stage Setup Filter ..... E-38
- Using MIDI ..... E-39
- Digital Piano Information ..... E-41

## **Reference ..... E-42**

- Tone List ..... E-42
- Drum Assignment List ..... E-46
- Arpeggio Type List ..... E-49
- Wave List ..... E-49
- Instrument List ..... E-51

## **MIDI Implementation Chart**

Company and product names used in this manual may be registered trademarks of others.

# General Guide

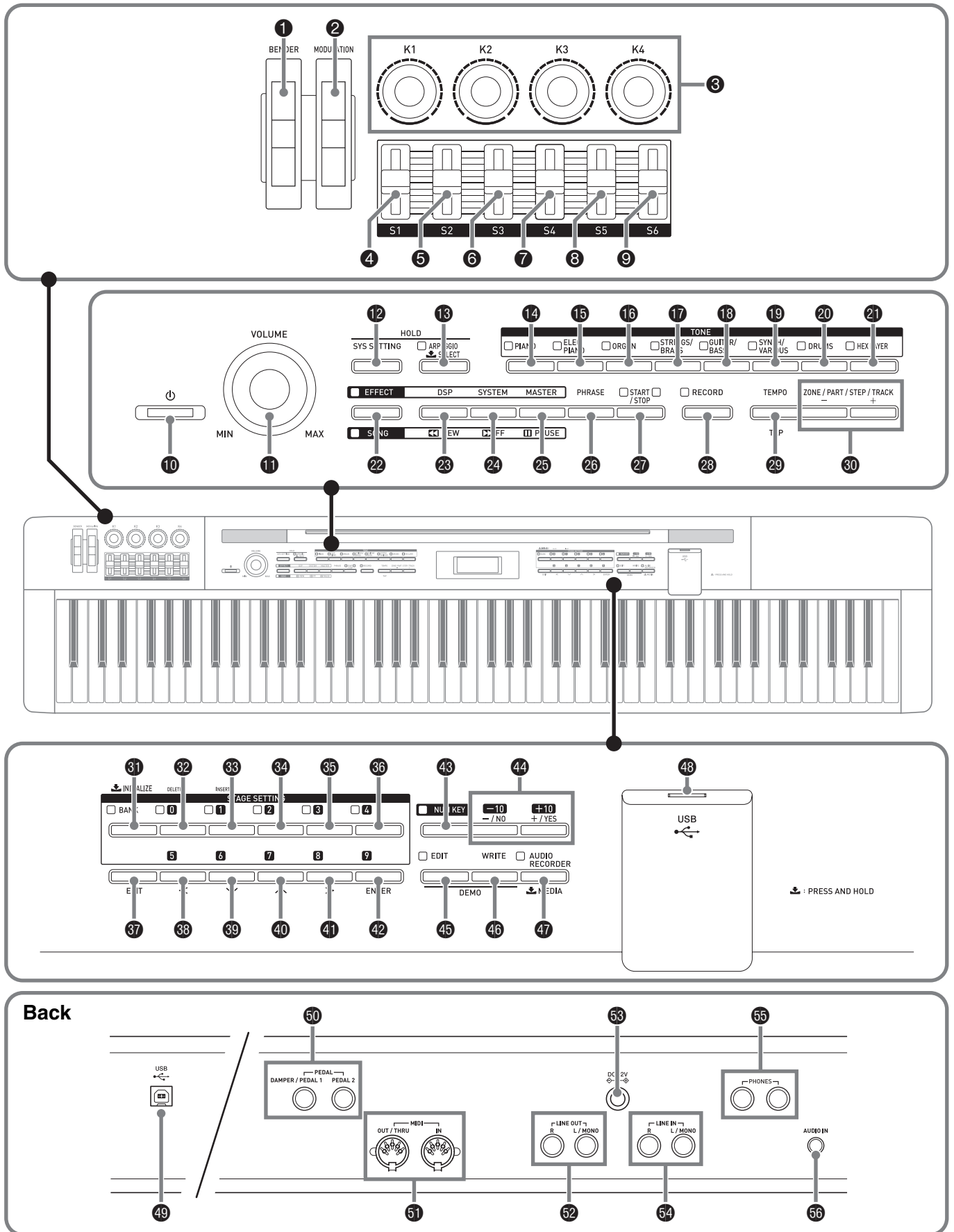

- This manual uses the numbers and names below to refer to buttons and controllers.

- ❶ **BENDER** wheel
- ❷ **MODULATION** wheel
- ❸ **K1** through **K4** knobs
- ❹ **S1** slider
- ❺ **S2** slider
- ❻ **S3** slider
- ❼ **S4** slider
- ❽ **S5** slider
- ❾ **S6** slider
- ❿ **⏻ (POWER)** button
- ⓫ **VOLUME** controller
- ⓬ **SYS SETTING** button
- ⓭ **ARPEGGIO** button
- ⓮ **PIANO** button
- ⓯ **ELEC PIANO** button
- ⓰ **ORGAN** button
- ⓱ **STRINGS/BRASS** button
- ⓲ **GUITAR/BASS** button
- ⓳ **SYNTH/VARIOUS** button
- ⓴ **DRUMS** button
- ⓵ **HEX LAYER** button
- ⓶ **EFFECT, SONG** button
- ⓷ **DSP, REW** button
- ⓸ **SYSTEM, FF** button
- ⓹ **MASTER, PAUSE** button
- ⓺ **PHRASE** button
- ⓻ **START/STOP** button
- ⓼ **RECORD** button
- ⓽ **TEMPO, TAP** button
- ⓿ **ZONE/PART/STEP/TRACK, +/-** buttons
- Display
- ⓫⓪ **BANK, INITIALIZE** button
- ⓫⓫ **0, DELETE** button
- ⓫⓬ **1, INSERT** button
- ⓫⓭ **2** button
- ⓫⓮ **3** button
- ⓫⓯ **4** button
- ⓫⓰ **EXIT** button
- ⓫⓱ **5, <** button
- ⓫⓲ **6, ∨** button
- ⓫⓳ **7, ^** button
- ⓫⓴ **8, >** button
- ⓫⓵ **9, ENTER** button
- ⓫⓶ **NUM KEY** button
- ⓫⓷ **-/NO, +/YES** buttons
- ⓫⓸ **EDIT** button
- ⓫⓹ **WRITE** button
- ⓫⓺ **AUDIO RECORDER, MEDIA** button
- ⓫⓻ **USB** flash drive port
- ⓫⓼ **USB** port
- ⓫⓽ **DAMPER/PEDAL1, PEDAL2** jacks
- ⓫⓿ **MIDI OUT/THRU, IN** terminals
- ⓬⓪ **LINE OUT R, L/MONO** jacks
- ⓬⓫ **DC 12V** terminal
- ⓬⓬ **LINE IN R, L/MONO** jacks
- ⓬⓭ **PHONES** jacks
- ⓬⓮ **AUDIO IN** jack

## Read the Separate USER'S GUIDE (Basics) !

Before using this Digital Piano for the first time, be sure to read the separate USER'S GUIDE (Basics) to familiarize yourself with basic operations.

## Power On Precaution!

When turning on power, make sure neither of the pedals (connected to Pedal 1 and/or Pedal 2) is depressed when you press the **⏻ (⏻)** button. Turning on power while a pedal is depressed may cause problems with effects.

- If you experience such problems, turn off power, make sure a pedal is not depressed, and turn power back on again.

## “WriteError” Message

If you should ever get a “WriteError” (data write error) message on the display when you try to save data in Digital Piano memory, make a note of the numeric code displayed in the message. The code indicates the cause of the error and what you need to do to correct it.

Code	Cause	Action
-4	Battery power is low.	<ul style="list-style-type: none"> <li>• Connect the AC adaptor.</li> <li>• Replace the batteries.</li> </ul>
-1, -2, -3, -5, -6	Data writing failed for some reason.	<ul style="list-style-type: none"> <li>• Try saving the data again.</li> <li>• Return the Digital Piano to its initial factory default settings.</li> </ul> <p>Important! Your user data will be deleted when you return the Digital Piano to its initial factory default settings.</p>

## Zone, Part, MIDI Receive Channel, and Tone Relationships

The tones of this Digital Piano are made up of the 16 parts shown below, plus externally input parts.

### ■ Relationship between Zones, Parts, and Tones

Part Name	Part Number	Selectable Tone Categories				MIDI Receive from External Source (page E-39)	Song Sequencer
		Piano	Melody Tones	Drum Sounds	Hex Layer		
Zone Part 1*	01	○	○	○	○	○	○
Zone Part 2	02	○	○	-	○	○	○
Zone Part 3	03	○	○	-	-	○	○
Zone Part 4	04						
---	05 - 16	○	○	○	-	○	○
External Input	-	- Sound input via <b>64</b> (LINE IN R, L/MONO) and <b>65</b> (AUDIO IN) on the back of the Digital Piano (page E-36)					

#### \* About zones and zone parts

Keyboard, pedal, button, and other operations not only affect the Digital Piano's tones, they are also sent as MIDI data and affect any external device (electronic musical instrument or computer) connected to the Digital Piano. Because of this, parameter setting areas called "zones" are used to configure common settings for internal and external use. The sound source parts inside the Digital Piano are called "zone parts". For example, if you select a tone for the Digital Piano's Zone 2, that tone is used for the internal sound source's Zone 2 and for the part that corresponds to MIDI Channel 2 of the external device.

- You can change the relationships between zones and MIDI data send channels, if you want (page E-31).

#### Digital Piano Internal Sound Source

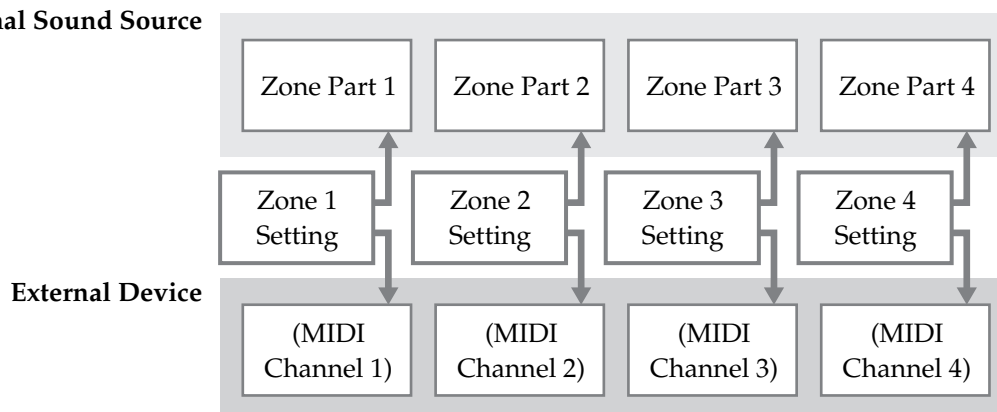

You can perform using four tones at the same time. You also can use "stage setups" to register tone, phrase sequencer, and other Digital Piano setups for quick and simple recall while you are performing.

## Data Configuration and Relationships

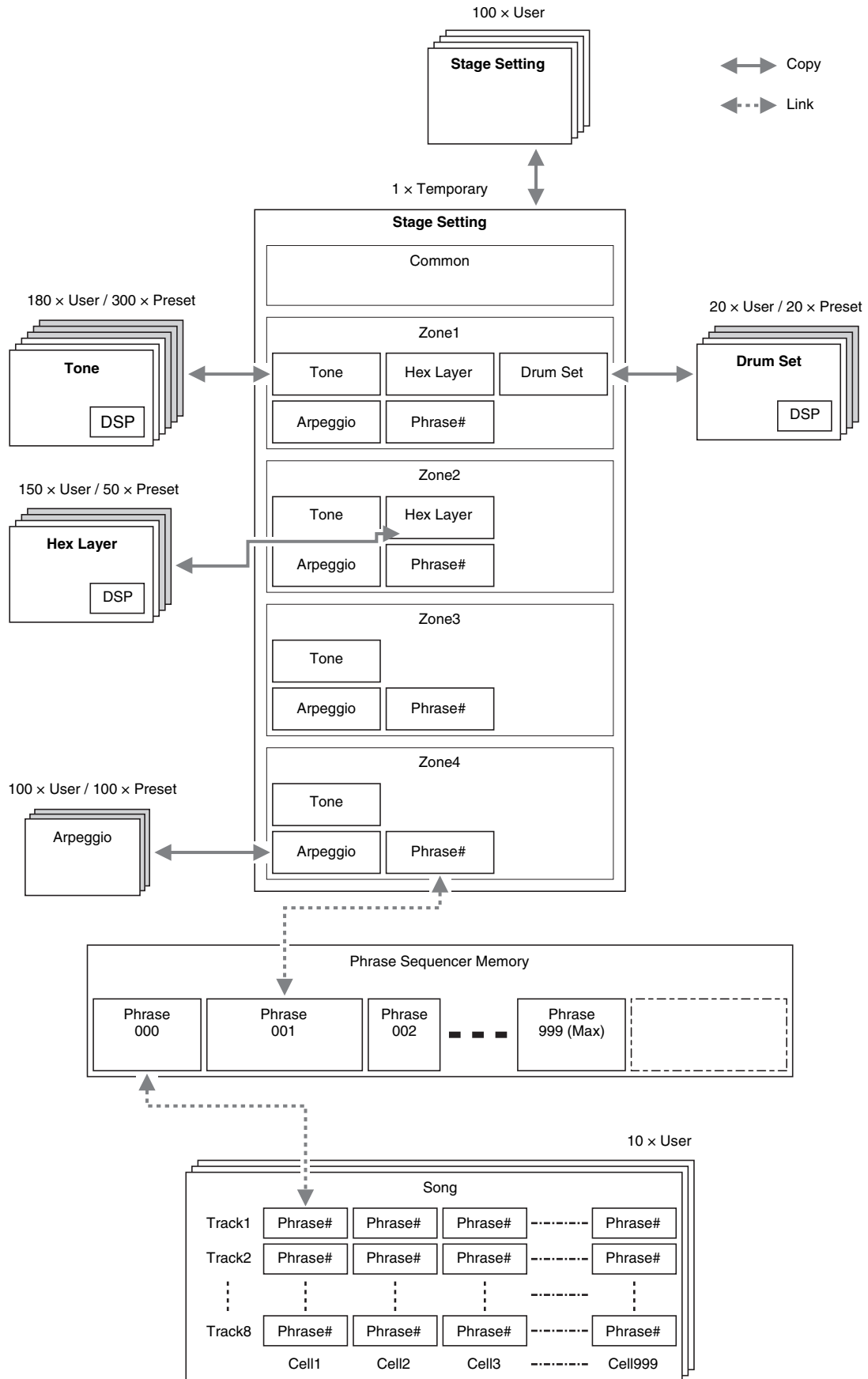



In the case of an internal sound source, various types of editing can be performed to create sounds by selecting a DSP, configuring DSP settings, editing tones, etc. The signals following tone creation are collected together and then output via equalizers that enable adjustment using common master effects.

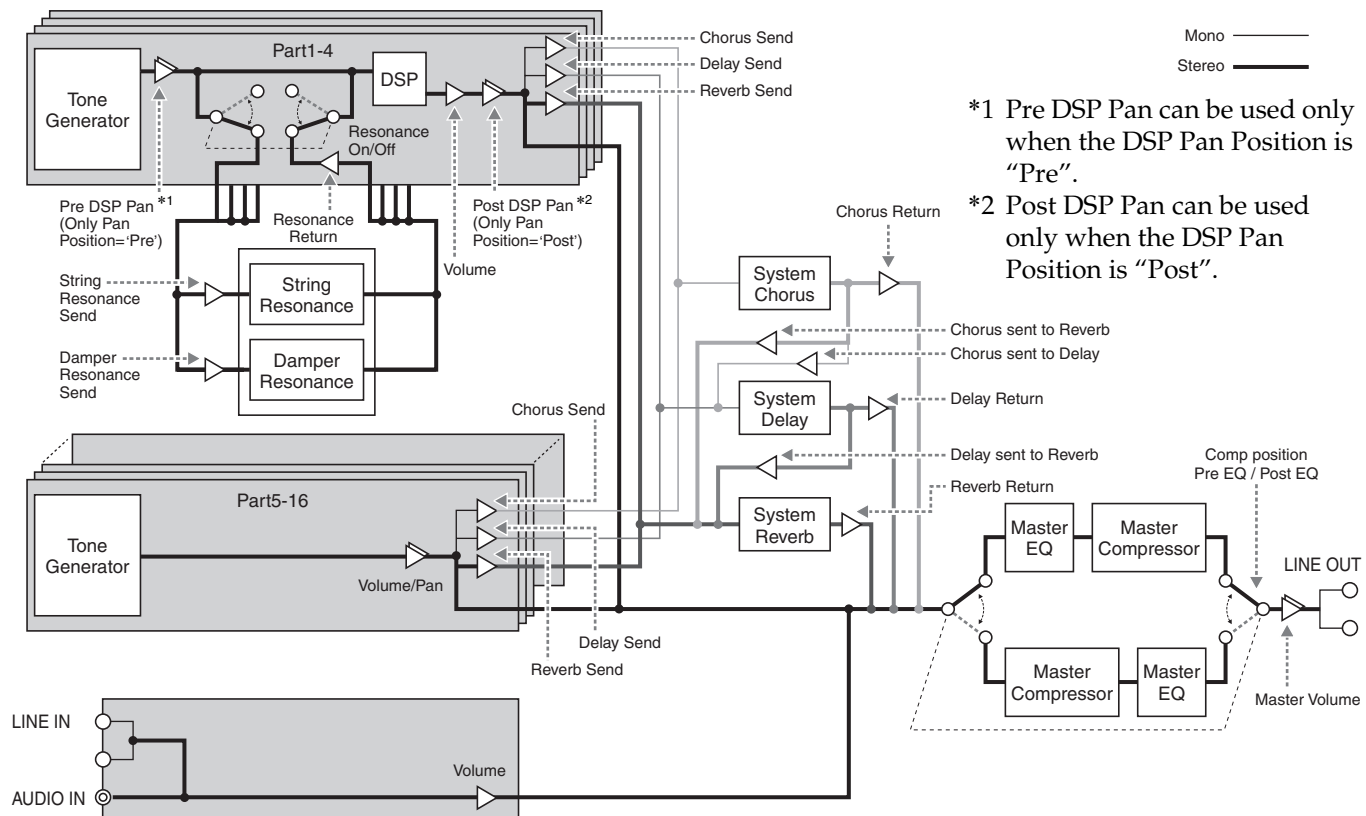

## Controlling Sounds

You can use controllers (pedals, wheels, knobs, and sliders) to instantly change the pitch and volume of notes, the envelope, and other parameters as you perform (page E-34).

- Two targets can be specified for a single controller. For example, configuring the settings below would make it possible to change the balance between layers with a single slider.
  - 1) Select Layer 1 Volume as Target 1 of Slider 1 (page E-35), and specify a minimum value (Min Value) of 0 and a maximum value (Max Value) of 127.
  - 2) Select Layer 2 Volume as Target 2 of Slider 1, and specify a minimum value (Min Value) of 127 and a maximum value (Max Value) of 0.

### Using a Pedal

You can configure a pedal so depressing it sustains a tone, applies a softening effect, or to change parameters assigned to the pedal.

- The pedal can be configured so its on/off status causes gradual increase or decrease of sound volume. For more information, see “On Rate” and “Off Rate” (page E-35).
- You can specify the effect applied by selecting the following in the Stage Setup Editable Parameters: Pedal1-2 Edit > Ent. See page E-35 for more information.

### Using the Bender Wheel

The ❶ (BENDER) wheel can be configured so it seamlessly raises or lowers the pitch of notes whenever it is rotated.

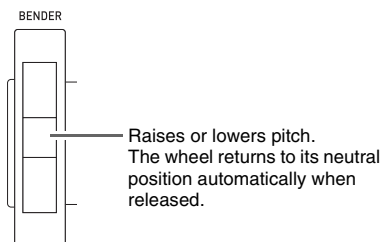

- ❶ (BENDER) wheel operation can change pitch only within the bend range.
- You can configure the bend range of the ❶ (BENDER) wheel by configuring the following settings in the Stage Setup Editable Parameters: “Bend Range Down”, “Bend Range Up” (page E-32).

## Using the Modulation Wheel, Knobs and Sliders

A ❷ (MODULATION) wheel, ❸ knobs (K1 through K4), and ❹ sliders (S1) through ❹ (S6) can be used to adjust volume, effects, the elements that make up tones, and other factors.

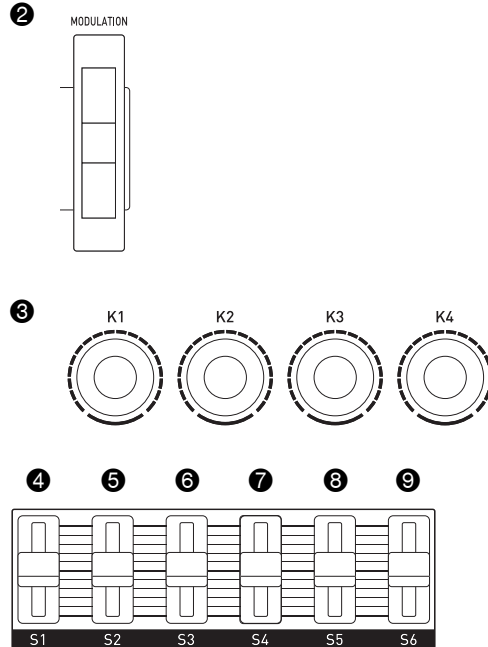

- You can specify the effect assigned to each of these controllers using the Stage Setup Editable Parameters shown below. See page E-35 for more information.
  - ❷ (MODULATION): Modulation Edit > Ent
  - ❸ (K1 - K4): Knob1-4 Edit > Ent
  - ❹-❹ (S1 - S6): Slider1-6 Edit > Ent

# Operations Common to All Modes (Tutorial)

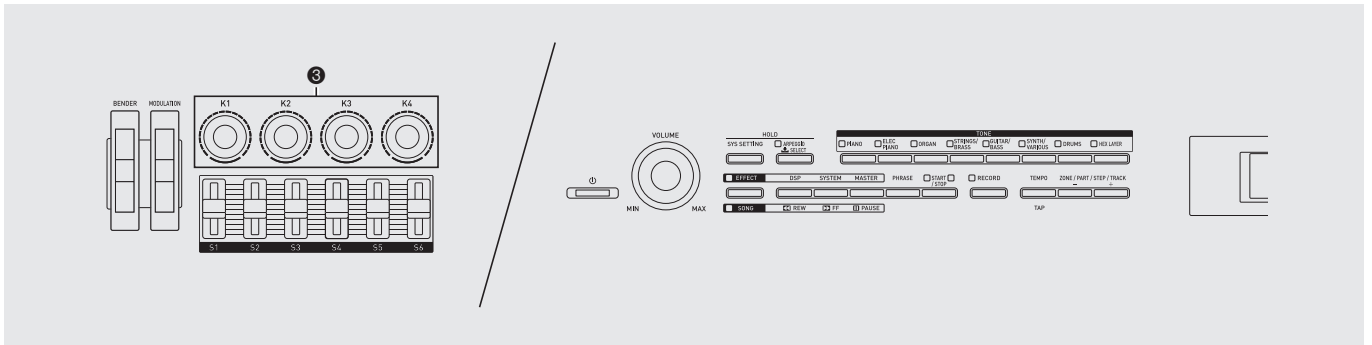

## Using the Knobs for Input

When performing editing screen operations and configuring system settings, you can use the knobs to move the cursor around the screen and to input numbers, values, etc.

### To move the cursor

1. Rotate **Ⓢ (K1)** knob.

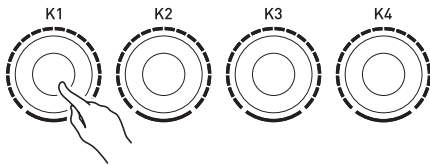

### To input a number, value, or letter

1. Rotate **Ⓢ (K2)** knob.

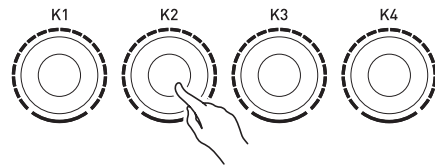

- On the arpeggio step editing screen (see “Editing an Arpeggio” on page E-25), the four knobs control the settings shown below.

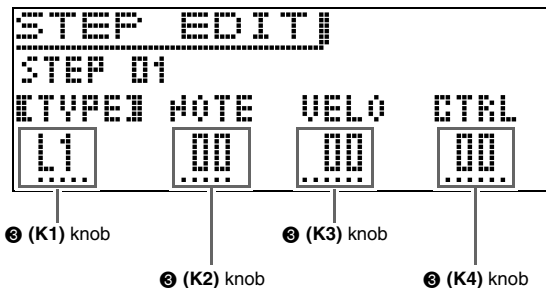

- With the song sequencer, the four knobs correspond to the settings shown below.

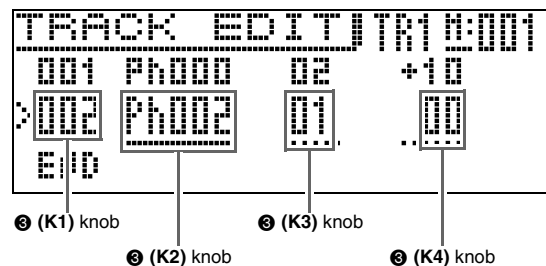

# Using Built-in Tones (Tutorial)

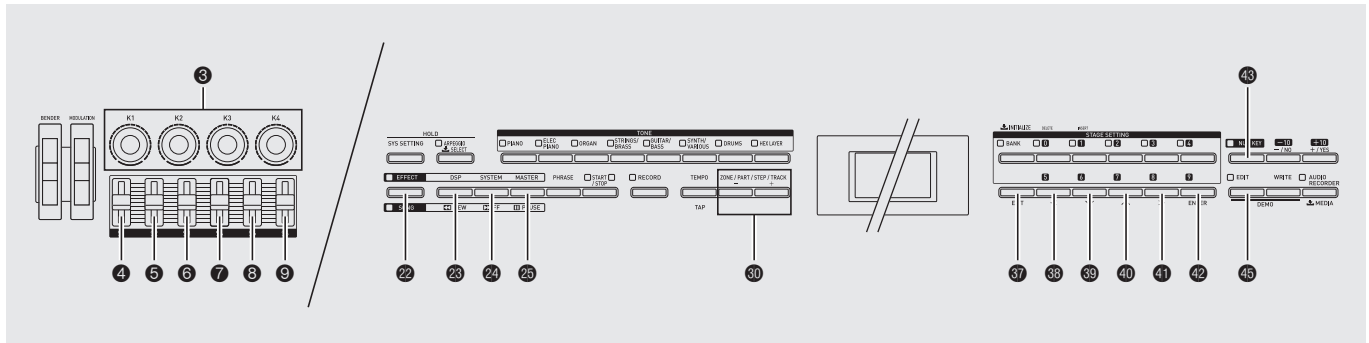

You can use the editing procedures explained in this section to edit tones and apply effects as desired. After editing a tone, you can give it a name and save it as a user tone.

- For information about tone editing, see “To edit a tone” (page E-10).
- For information about applying an effect (DSP and/or system effect) to a tone, see “Applying Effects to Notes” (page E-18).
- To change the effects and/or functions assigned to wheel, knob, and slider operations, see “Using the Stage Setups (Tutorial)” (page E-31).

## To edit a tone

1. Specify the number of the tone you want to edit.
2. Press the **45** (**EDIT**) button.  
This displays the editing screen.
3. Use the **39** (**∨**) and **40** (**∧**) buttons to select “Tone”, and then press the **42** (**ENTER**) button.

```

SELECT EDIT TARGET
# Stage Settings  >Ent
# Tone           >Ent
    
```

4. Use the **38** (**<**), **39** (**∨**), **40** (**∧**), and **41** (**>**) buttons to select a setting item.
  - If “>ENT” is on the display, it means that there are more setting items that can be edited in the operation you are performing. In this case, pressing the **42** (**ENTER**) button will advance to the next editing page.
  - The setting items that appear on the editing screen depend on the tone you select.
  - For information about editable parameters, see the explanations about each tone category from “Editable Melody Tone Parameters” (page E-11) through “Editable Hex Layer Tone Parameters” (page E-14).
5. Change parameters as desired.
6. After you finish with your edits, press the **37** (**EXIT**) button.
  - Press the **37** (**EXIT**) button as many times as required to return to the screen where you were before you started editing.

## To change the name of a tone





















1. Perform steps 1 through 3 of the procedure under “To edit a tone”, above.
2. Use the **38** (**<**), **39** (**∨**), **40** (**∧**), and **41** (**>**) buttons to select “NameEdit”, and then press the **42** (**ENTER**) button.
3. Change the name.
4. After you finish with your edits, press the **37** (**EXIT**) button.
  - Press the **37** (**EXIT**) button as many times as required to return to the screen where you were before you started editing.

## Editable Parameters

- Shaded cells indicate a group made up of multiple setting items. Pressing the **42** (ENTER) button displays the setting items of that group.

### ■ Editable Melody Tone Parameters

Display Text	Description	Settings
Pitch >Ent	<p>Pitch envelope. The editable parameters in this group affect the pitch of notes.</p> <ul style="list-style-type: none"> <li>• The figure below also applied to filter, amp, and other envelopes. With the pitch envelope, the pitch of the sound corresponds to the vertical (Level) axis.</li> <li>• With a hex layer tone envelope, Decay Time can be divided into three parts and Release Time can be divided into two parts and edited.</li> <li>• When Decay Level 3 is reached during key release note on, an immediate transition is made to Release Level 1 without sustain.</li> <li>• The setting ranges of the parameters below are relative changes (relative to the presets of the tone) in the case of melody tones and drum tones. When editing a hex layer tone, they are absolute changes that have no relation to the presets of the tone. <ul style="list-style-type: none"> <li>– Time and level of each envelope</li> <li>– Rate, depth, delay, rise, modulation depth of LFO (page E-12)</li> </ul> </li> </ul> <p>IL : Initial Level                      RT : Release Time  AT : Attack Time                      (RT1: Release Time 1)  AL : Attack Level                      (RT2: Release Time 2)  DT : Decay Time                      RL : Release Level  (DT1: Decay Time 1)                  (RL1: Release Level 1)  (DT2: Decay Time 2)                  (RL2: Release Level 2)  (DT3: Decay Time 3)  DL : Decay Level  (DL1: Decay Level 1)  (DL2: Decay Level 2)  (DL3: Decay Level 3)</p>	
Octave Shift	Octave shift. Changes the tone of notes in octave units.	-2 - 0 - +2
Initial Level	Initial level. Pitch of the sound at initial note on.	-64 - 0 - +63
Attack Time	Attack time. Time it takes until the attack level is reached from the initial level.	-64 - 0 - +63
Release Time	Release time. Time it takes to reach Release Level after a key is released.	-64 - 0 - +63
Release Level	Release level. Target level reached immediately after a key is released.	-64 - 0 - +63
Stretch Tune	Stretch tuning. Sharpens high notes and flattens low notes to achieve stretch tuning. Turn off this setting to play with normal (non-stretch) tuning.	Off, Piano1, Piano2, Piano3, Piano4, Piano5, E.Piano1, E.Piano2
Filter >Ent	<p>Filter. This is a group of editable parameters associated with filters (tones).</p> <ul style="list-style-type: none"> <li>• With this group, the vertical (Level) axis in the pitch envelope diagram corresponds to how the filter is applied.</li> <li>• For details about the setting items below, see "Pitch Envelope".</li> </ul> <p>Initial Level, Attack Time, Release Time, Release Level</p>	
Cutoff	Cutoff frequency. Specifies the filter cutoff frequency.	-64 - 0 - +63

Display Text	Description	Settings																
Resonance	Resonance. Specifies the degree of cutoff of the tone in the vicinity of the cutoff frequency.	-64 - 0 - +63																
Velocity Sense	Velocity sense. Specifies the degree of change in the filter in accordance with change in keyboard playing touch.	-64 - 0 - +63																
Envelope Depth	Envelope depth. Specifies how the envelope is applied.	0 - 127																
Attack Level	Attack level. Target level reached immediately after note on.	-64 - 0 - +63																
Decay Time	Decay time. Time it takes for the sound to reach the decay level from the attack level.	-64 - 0 - +63																
Decay Level	Decay level. Level the sound is sustained as long as a key or pedal is depressed.	-64 - 0 - +63																
Amp >Ent	Amp. This is a group of editable parameters associated with the amp (volume). <ul style="list-style-type: none"> <li>The vertical (Level) axis in the pitch envelope diagram corresponds to the volume in the case of this group.</li> <li>For details about the setting items below, see "Pitch Envelope". Initial Level, Attack Time, Release Time</li> <li>For details about the setting items below, see "Filter", above. Attack Level, Decay Time, Decay Level</li> </ul>																	
Volume	Volume. Specifies the amp volume.	0 - 127																
Velocity Sense	Velocity sense. Specifies the degree of change in volume in accordance with change in keyboard playing touch.	-64 - 0 - +63																
Effect >Ent	Effect. This is a group of editable effect function parameters. For details, see "Applying Effects to Notes" (page E-18).																	
DSP Edit >Ent	DSP edit. This is a group of editable effect function DSPs (page E-18). Press the <b>⏏</b> (ENTER) button to advance to the DSP editing screen (page E-18).																	
Chorus Send	Chorus send. Specifies how chorus (page E-18) is applied to a tone.	0 - 127																
Delay Send	Delay send. Specifies how delay (page E-18) is applied to a tone.	0 - 127																
Reverb Send	Reverb send. Specifies how reverb (page E-18) is applied to a tone.	0 - 127																
LFO >Ent	LFO. This is a group of editable LFO parameters applied to pitch, filter, and amp.																	
Pitch Wave FilterAmpWave	Wave type. Specifies one of the following wave types to be used for LFO. FilterAmpWave is shared by filter and amp. <table border="0" style="width: 100%; border-collapse: collapse;"> <tr> <td style="width: 30%;">Sin (sine wave)</td> <td style="width: 20%; text-align: center;"></td> <td style="width: 30%;">Puls 1:3 (square wave 1:3)</td> <td style="width: 20%; text-align: center;"></td> </tr> <tr> <td>Tri (triangle wave)</td> <td style="text-align: center;"></td> <td>Puls 2:2 (square wave 2:2)</td> <td style="text-align: center;"></td> </tr> <tr> <td>Saw up (sawtooth up wave)</td> <td style="text-align: center;"></td> <td>Puls 3:1 (square wave 3:1)</td> <td style="text-align: center;"></td> </tr> <tr> <td>Saw down (sawtooth down wave)</td> <td style="text-align: center;"></td> <td></td> <td></td> </tr> </table>	Sin (sine wave)		Puls 1:3 (square wave 1:3)		Tri (triangle wave)		Puls 2:2 (square wave 2:2)		Saw up (sawtooth up wave)		Puls 3:1 (square wave 3:1)		Saw down (sawtooth down wave)				Refer to the cell to the left.
Sin (sine wave)		Puls 1:3 (square wave 1:3)																
Tri (triangle wave)		Puls 2:2 (square wave 2:2)																
Saw up (sawtooth up wave)		Puls 3:1 (square wave 3:1)																
Saw down (sawtooth down wave)																		
Pitch Rate FilterAmpRate	Rate. LFO speed (frequency). FilterAmpRate is shared by filter and amp.	-64 - 0 - +63																
Pitch Depth Filter Depth Amp Depth	Depth. Specifies how LFO is applied.	-64 - 0 - +63																
Pitch Delay Filter Delay Amp Delay	Delay. Specifies the degree of delay in the timing for applying LFO.	-64 - 0 - +63																

Display Text	Description	Settings
Pitch Rise Filter Rise Amp Rise	Rise. Specifies the time it takes from the start of application of the LFO until the effect reaches the level specified by Depth, above.	-64 - 0 - +63
Pitch Mod.Depth Filter Mod.Depth Amp Mod.Depth	Modulation depth. Specifies how modulation is applied to the LFO.	-64 - 0 - +63
Pan >Ent	Pan. This is a group of editable parameters associated with the panning (sound stereo position).	
Dynamic Panning	Dynamic panning. To reflect changes in part panning in the sound being produced, select "On" for this setting. Select "Off" if you do not want changes reflected.	Off, On
Pan Position	Panning position. Select "PreDSP" to apply panning before the DSP, or "PostDSP" to apply panning after the DSP.	PreDSP, PostDSP

## ■ Editable Drum Tone Parameters

Display Text	Description	Settings
Inst Edit >Ent	Instrument edit. This is a group of editable instruments assigned to each keyboard. <ul style="list-style-type: none"> <li>• Press a keyboard key to specify the key to be edited.</li> <li>• For details about "DSP Edit", see "Applying Effects to Notes" (page E-18).</li> </ul>	C - G9
Inst Select	Instrument number select. Specifies the number of the drum tone assigned to each key.	See "Instrument List" at the back of this manual.
Note Off Mode	Note off mode. Turning on this setting causes note off to be performed when a key is released.	Off, On
Assign Group	Assign group. Specifies as a value from 1 to 15 which group the currently selected key should be placed into. Only one keyboard in a group is sounded at the same time (non-polyphonic).	Off, 1 - 15
Pitch >Ent	Pitch envelope. For details, see the melody tone "Pitch Envelope" on page E-11. <ul style="list-style-type: none"> <li>• For details about the setting items below, see the melody tone "Pitch Envelope" on page E-11. Initial Level, Attack Time</li> </ul>	
Coarse Tune	Coarse tune. Changes the pitch of notes by semitone units.	-24 - 0 - +24
Fine Tune	Fine tune. Fine tunes the pitch of the sound. Lowers the value up to -256 or raises the value up to +255 in semitone steps.	-256 - 0 - +255
Filter >Ent	Filter. For details, see the melody tone "Filter" on page E-11. <ul style="list-style-type: none"> <li>• For details about the setting items below, see the melody tone "Filter" on page E-11. Cutoff, Resonance, Envelope Depth, Attack Level, Decay Time, Decay Level</li> <li>• For details about the setting items below, see the melody tone "Pitch Envelope" on page E-11. Initial Level, Attack Time</li> </ul>	
Amp >Ent	Amp. For details, see the melody tone "Amp" on page E-12. <ul style="list-style-type: none"> <li>• For details about the setting items below, see the melody tone "Amp" on page E-12. Volume</li> <li>• For details about the setting items below, see the melody tone "Pitch Envelope" on page E-11. Initial Level, Attack Time</li> <li>• For details about the setting items below, see the melody tone "Filter" on page E-11. Attack Level, Decay Time, Decay Level</li> </ul>	

Display Text	Description	Settings
Pan	Pan. Specifies the stereo position of drum sound.	-64 - 0 - +63
Effect >Ent	Effect. This is a group of editable effect function DSPs (page E-18). Press the <b>42</b> (ENTER) button to advance to the DSP editing screen. <ul style="list-style-type: none"> <li>For details about the setting items below, see the melody tone "Effect" on page E-12. Chorus Send, Delay Send, Reverb Send</li> <li>Values produced by multiplying send values configured for instrument-specific effects (Effect &gt;Ent) and send values configured for global effects (Common Effect &gt;Ent) are batch sent to the system.</li> <li>When "DSP On/Off" is turned on (DSP applied), chorus, delay, and reverb settings can be configured within "Common Effect &gt;Ent" below.</li> </ul>	
DSP On/Off	DSP on/off. Specifies whether or not DSP should be applied to tones.	Off, On
Common Effect >Ent	Common effect. This is a group of editable effect function parameters. For details, see the melody tone "Effect" on page E-12. <ul style="list-style-type: none"> <li>For details about the setting items below, see the melody tone "Effect" on page E-12. Chorus Send, Delay Send, Reverb Send</li> </ul>	
Pan >Ent	Pan. This is a group of editable parameters associated with panning (sound stereo position). <ul style="list-style-type: none"> <li>For details about the setting items below, see the melody tone "Pan" on page E-13. Dynamic Panning, Pan Position</li> </ul>	

## ■ Editable Hex Layer Tone Parameters

Hex Layer tones have two types of editable parameters: parameters that affect a specific layer and parameters that affect all layers.

- The six sliders (**4** to **9**) and four knobs (**3**) can be used for quick and easy adjustment of certain settings using the setting items shown below (page E-8).

### Editable Parameters that Affect a Specific Layer

- Select "Layer Edit >Ent" and then press the **42** (ENTER) button to enter the group.
- Use the **30** (PART) minus (-) and plus (+) buttons to select the number of the layer you want to edit.

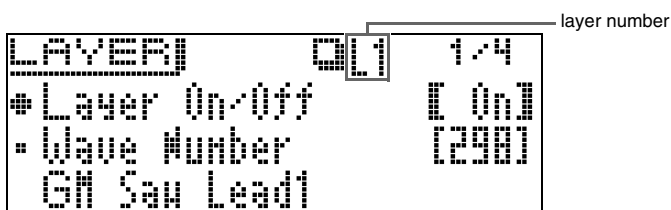

- When "ALL" (all layers) is selected as the layer number, an x-mark may be displayed on the left side of the display showing the part being edited. This indicates that all of the layers do not have the same setting for the currently selected parameter.



## Editable Parameters

Display Text	Description	Settings
Layer On/Off	Layer on/off. Selecting off disables layer.	Off, On
Wave Number	Wave number. Selects a waveform type. <ul style="list-style-type: none"> <li>Refer to the "Wave List" at the back of this manual for information about wave types.</li> </ul>	See "Wave List" at the back of this manual.
Pitch >Ent	Pitch envelope. For details, see the melody tone "Pitch Envelope" on page E-11. <ul style="list-style-type: none"> <li>For details about the setting items below, see the melody tone "Pitch Envelope" on page E-11. You can input "Initial Level" and "Release Level" values in the range of -256 to 0 to +255. You can input "Attack Time" and "Release Time" values in the range of 0 to 127. Octave Shift, Initial Level, Attack Time, Release Time, Release Level</li> <li>For details about the setting items below, see drum tone "Pitch Envelope" on page E-13. Coarse Tune, Fine Tune</li> <li>For details about the setting items below, see the melody tone "Filter" on page E-11. You can input "Attack Level" and "Decay Level" values in the range of -256 to 0 to +255. You can input a "Decay Time" in the range of 0 to 127. Attack Level, Decay Time, Decay Level</li> </ul>	
Key Follow	Key follow. Adjusts the amount of pitch change between neighboring keyboard keys. A higher value represents greater change.	-128 - 0 - +127
Key Follow Base	Key follow base. Keyboard key that is the center of key follow.	C - G9
Split Shift	Split shift. Counting from the keyboard key that is pressed, the waveform that sounds is the one assigned to the keyboard key that is the specified split shift amount above or below the pressed key. The pitch used is the one that corresponds to the pressed keyboard key.	-12 - 0 - +12
LFO Layer Depth	LFO layer depth. Adjusts how LFO is applied to each layer.	0 - 127
Filter >Ent	Filter. For details, see the melody tone "Filter" on page E-11. <ul style="list-style-type: none"> <li>For details about the setting items below, see the melody tone "Filter" on page E-11. You can input a value in the range from 0 to 127. Cutoff, Resonance, Attack Level, Envelope Depth</li> <li>For details about the setting items below, see the melody tone "Pitch Envelope" on page E-11. You can input a value in the range from 0 to 127. Initial Level, Attack Time</li> </ul>	
Filter Type	Filter type. Specifies the range cut by the filter. <p>LPF1: 6dB/oct filter for low-frequency band components. No resonance effect. Suitable for acoustic instruments.</p> <p>LPF2: 12dB/oct filter for low-frequency band components. No resonance effect. Suitable for acoustic instruments.</p> <p>LPF3: 12dB/oct filter for low-frequency band components. With resonance effect. Suitable for synthesized tones.</p> <p>BPF : 6dB/oct filter for band components in the vicinity of the cutoff frequency. With resonance effect.</p> <p>HPF : 12dB/oct filter for high-frequency band components. With resonance effect.</p>	Refer to the cell to the left.
Velocity Sense	Velocity sense. Specifies the degree of change in the filter in accordance with keyboard press velocity.	-64 - 0 - +63
Decay 1 Time	Decay 1 time. Time it takes for the sound to reach the decay 1 level from the attack level.	0 - 127
Decay 1 Level	Decay 1 level. Target level for change from the attack level up to the Decay 1 level.	0 - 127
Decay 2 Time	Decay 2 time. Time it takes for the sound to reach the Decay 2 level from the Decay 1 level.	0 - 127
Decay 2 Level	Decay 2 level. Second target level for change from Decay 1 level up to the Decay 2 level.	0 - 127

Display Text	Description	Settings
Decay 3 Time	Decay 3 time. Time it takes for the sound to reach the Decay 3 level from the Decay 2 level.	0 - 127
Decay 3 Level	Decay 3 level. Third target level for change from Decay 2 level up to the Decay 3 level.	0 - 127
Release 1 Time	Release 1 time. Time it takes to reach Release Level 1 after a key is released.	0 - 127
Release 1 Level	Release 1 level. Target level reached immediately after a key is released.	0 - 127
Release 2 Time	Release 2 time. Time it takes to reach Release Level 2 from Release Level 1.	0 - 127
Release 2 Level	Release 2 level. Second target level reached after a key is released.	0 - 127
Key Follow	Key follow. Adjusts the amount of filter change between neighboring keyboard keys. A higher value represents greater change.	-128 - 0 - +127
Key Follow Base	Key follow base. Keyboard key that is the center of key follow.	C - G9
LFO Layer Depth	LFO layer depth. Adjusts how LFO is applied to each layer.	0 - 127
Amp >Ent	<p>Amp. For details, see the melody tone “Amp” on page E-12.</p> <ul style="list-style-type: none"> <li>For details about the setting items below, see the melody tone “Amp” on page E-12. Volume, Velocity Sense</li> <li>For details about the setting items below, see the drum tone “Amp” on page E-13. Pan</li> <li>For details about the setting items below, see the melody tone “Pitch Envelope” on page E-11. You can input a value in the range from 0 to 127. Initial Level, Attack Time</li> <li>For details about the setting items below, see the melody tone “Filter” on page E-11. You can input a value in the range from 0 to 127. Attack Level</li> <li>For details about the setting items below, see the hex layer “Filter” on page E-15. Decay 1 Time, Decay 1 Level, Decay 2 Time, Decay 2 Level, Decay 3 Time, Decay 3 Level, Release 1 Time, Release 1 Level, Release 2 Time</li> </ul>	
Key Follow	Key follow. Adjusts the amount of volume change between neighboring keyboard keys. A higher value represents greater change.	-128 - 0 - +127
Key Follow Base	Key follow base. Keyboard key that is the center of key follow.	C - G9
LFO Layer Depth	LFO layer depth. Adjusts how LFO is applied to each layer.	0 - 127
Effect >Ent	<p>For details, see the melody tone “Effect” on page E-12.</p> <ul style="list-style-type: none"> <li>For details about the setting items below, see the drum tone “Effect” on page E-14. DSP On/Off</li> <li>For details about the setting items below, see the melody tone “Effect” on page E-12. Chorus Send, Delay Send, Reverb Send</li> <li>Values produced by multiplying send values configured for instrument-specific effects (Effect&gt;Ent) and send values configured for global effects (Common Effect&gt;Ent) are batch sent to the system.</li> <li>When “DSP On/Off” is turned on (DSP applied), chorus, delay, and reverb settings can be configured within “Common Effect &gt;Ent” below.</li> </ul>	
Key Range Low	<p>Key Range Low. Specifies the lower limit of the enabled keyboard range. Nothing sounds when any keyboard key below this range is pressed.</p> <ul style="list-style-type: none"> <li>After pressing the <b>45 (NUM KEY)</b> button to enter the number input mode, you can use the keyboard keys to enter values.</li> </ul>	C - G9

Display Text	Description	Settings
Key Range High	Key Range High. Specifies the upper limit of the enabled keyboard range. Nothing sounds when any keyboard key above this range is pressed. <ul style="list-style-type: none"> <li>After pressing the <b>43</b> (NUM KEY) button to enter the number input mode, you can use the keyboard keys to enter values.</li> </ul>	C - G9
VelocityRangeLow	Velocity range low. Specifies the minimum value of the effective velocity. No sound is produced when playing at a velocity less than this setting.	0 - 127
VelocityRangeHigh	Velocity range high. Specifies the maximum value of the effective velocity. No sound is produced when playing at a velocity greater than this setting.	0 - 127
Start Trigger	Start trigger. Specifies whether a note is sounded when a keyboard key is pressed (KeyOn) or when a keyboard key is released (KeyOff).	KeyOn, KeyOff

## Editable Parameters that Affect All Layers

### Editable Parameters

- Shaded cells indicate a group made up of multiple parameters. Press the **42** (ENTER) button to display the setting items that make up a group.

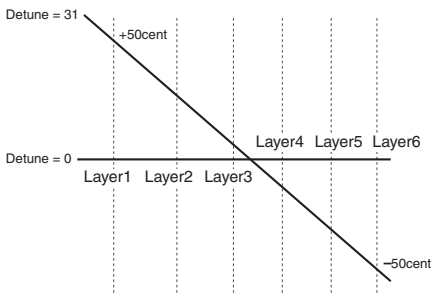
Display Text	Description	Settings
Init By Wave	Parameter initialization by wave selection. Select "On" to link the envelope and other parameters when the wave changes or "Off" not to link.	Off, On
Volume	Volume. Overall hex layer volume.	0 - 127
Common Effect >Ent	Common Effect. This is a group of editable effect function parameters. For details, see the melody tone "Effect" on page E-12. <ul style="list-style-type: none"> <li>For details about the setting items below, see the melody tone "Effect" on page E-12. Chorus Send, Delay Send, Reverb Send</li> </ul>	
LFO >Ent	LFO. This is a group of editable LFO parameters applied to the pitch of a layered tone. For details, see the melody tone "LFO" on page E-12. <ul style="list-style-type: none"> <li>For details about the setting items below, see the melody tone "LFO" on page E-12. You can input a value in the range from 0 to 127. Pitch Rate, Pitch Delay, Pitch Rise, Pitch Mod.Depth*, Filter Amp Rate, Filter Delay, Filter Rise, Filter Mod.Depth*, Amp Delay, Amp Rise, Amp Mod.Depth*</li> <li>* Performs same operation as the melody tone setting range (-64 to 0 to +63).</li> <li>For details about the setting items below, see the melody tone "LFO" on page E-12. Note, however, that the setting ranges of Pitch Depth, Filter Depth, and Amp Depth are -128 to 0 to +127. Pitch Wave, Filter Amp Wave, Pitch Depth, Filter Depth, Amp Depth</li> </ul>	
Detune	Detune. Causes the tuning of Layers 1 through 6 to be slightly different from each other. A larger setting value increases the amount of detuning. The maximum value (31) results in a difference of 100 cents (semitones) between Layer 1 and Layer 6. 	0 - 31

Display Text	Description	Settings
Pitch Lock 1-2 Pitch Lock 3-4 Pitch Lock 5-6	Pitch lock. When this setting is turned on for Layer 2, the Layer 2 pitch is changed to the same pitch as Layer 1 so both pitches are the same. The same is true for Layers 3 and 4, and Layers 5 and 6.	Off, On
Stretch Tune	For details, see the melody tone "Stretch Tune" on page E-11.	
KeyOffVel.Mode	Key off velocity mode. Select "KeyOff" to use the key off velocity as the key off velocity, or "KeyOn" to select the key on velocity. Select "Both" to reflect both (key on and key off) velocities.	KeyOff, KeyOn, Both
Pan >Ent	Pan. This is a group of editable parameters associated with panning (sound stereo position). For details, see the melody tone "Pan" on page E-13. <ul style="list-style-type: none"> <li>For details about the setting items below, see the melody tone "Pan" on page E-13.</li> </ul> Dynamic Panning, Pan Position	

## Applying Effects to Notes

Your Digital Piano has three types of effects, each of which includes the effects described below.

### A) Digital Signal Processor (DSP)

A collection of versatile DSP effects help to enhance the sound of tones. For example, distortion can be applied to an electric guitar sound to make it sound more powerful. There are 20 different DSP types, and the most appropriate one for the selected tone is applied automatically.

### B) System Effects (SYSTEM)

These effects are shared by all Digital Piano parts. The depth of an effect can be adjusted by specifying the send level from the part to each system effect.

- Chorus (System Chorus): Combines multiple layers of the same note to create a sound with more depth.
- Delay (System Delay): Delays the input signal and feeds it back to create a repeating effect and give notes more breadth.
- Reverb (System Reverb): Adds reverberation to make it sound like you are playing in a room or in a hall.

- Resonance (System Resonance): Simulates the resonance of acoustic piano strings.  
String Resonance (String Reso): Generates resonance for the strings of keys being pressed.  
Damper Resonance (Damper Reso): Generates string resonance when the damper pedal is pressed.  
Note that use of string resonance and damper resonance is supported only for certain tones.\*  
\* Tones for which the "Reso.Return Level" mixer parameter (page E-32) setting can be configured.

### C) Master Effects (MASTER)

These effects process the Digital Piano master output signal.

- Equalizer (Master Equalizer (EQ)): Adjusts the master frequency characteristics. The Master Equalizer can be used to adjust the frequency and gain of four frequency bands: low, mid1, mid2, and high.
- Compressor (Master Compressor): Compresses the instrument master output signal. This effect can be used to suppress level dispersion and limit the level of the input signal so it does not exceed the setting value.

## To apply an effect to a tone

1. Select the tone to which you want to apply the effect.
2. Press the **22** (EFFECT, SONG) button as many times as necessary until the indicator lamp on the **EFFECT** side is lit.

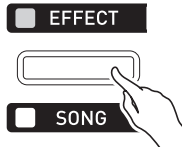

3. Press one of the buttons below, depending on the type of effect you want to apply.

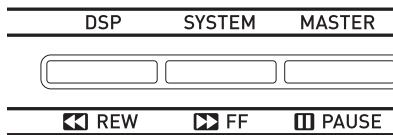

- A) DSP: **23** (DSP) button  
 B) SYSTEM: **24** (SYSTEM) button  
 C) MASTER: **25** (MASTER) button

This displays an effect setting screen. The screenshot below shows the screen when configuring SYSTEM settings.



- A button lamp will not light when you press the **23** (DSP), **24** (SYSTEM), or **25** (MASTER) button.
  - To find out whether an effect is on or off, check the effect type and setting.
  - The effect screen can also be displayed from the stage setup editing screen (page E-31).
4. Use the **38** (<), **39** (∨), **40** (∧), and **41** (>) buttons to select a setting item.
    - For details about editable parameters, see “Editable DSP Parameters”, “Editable SYSTEM Parameters”, and “Editable MASTER Parameters”, starting from page E-19.
    - If “>ENT” is on the display, it means that there are more parameters that can be edited in the operation you are performing. In this case, pressing the **42** (ENTER) button will advance to the next editing page.
  5. Change parameters as desired.

6. After you finish with your edits, press the **37** (EXIT) button.
  - Press the **37** (EXIT) button as many times as required to return to the screen where you were before you started editing.

## Temporarily Bypassing the DSP

Use the procedure below to temporarily bypass the DSP and switch the currently selected zone tone to one without the DSP effect applied.

- You can bypass the DSP for each tone of each zone.
1. Hold down the **23** (DSP) button until its lamp flashes.
  2. To cancel the bypass, hold down the **23** (DSP) button again until its lamp goes out.
    - Note that bypass is canceled even if you change to a different stage setup.

## ■ Editable DSP Parameters

- Select “Through” if you want to disable application of DSP.
- You can select different DSP effects for Parts 1 through 4.
- Parts 5 through 16 do not support use of DSP effects.

### --: Through

Select this option if you do not want to apply a DSP effect. There are no parameters that can be set while this option is selected.

### 01: Equalizer

This is a three-band equalizer.

#### Parameter Value Ranges:

- 1 :EQ1 Frequency (1.0k, 1.3k, 1.6k, 2.0k, 2.5k, 3.2k, 4.0k, 5.0k [Hz])  
Adjusts the center frequency of Equalizer 1.
- 2 :EQ1 Gain (-12 to 0 to +12)  
Adjusts the gain of Equalizer 1.
- 3 :EQ2 Frequency (1.0k, 1.3k, 1.6k, 2.0k, 2.5k, 3.2k, 4.0k, 5.0k [Hz])  
Adjusts the center frequency of Equalizer 2.
- 4 :EQ2 Gain (-12 to 0 to +12)  
Adjusts the gain of Equalizer 2.
- 5 :EQ3 Frequency (1.0k, 1.3k, 1.6k, 2.0k, 2.5k, 3.2k, 4.0k, 5.0k [Hz])  
Adjusts the center frequency of Equalizer 3.
- 6 :EQ3 Gain (-12 to 0 to +12)  
Adjusts the gain of Equalizer 3.
- 7 :Input Level (0 to 127)  
Adjusts the input level.
- 8 :Wet Level (0 to 127)  
Adjusts the level of the effect sound.
- 9 :Dry Level (0 to 127)  
Adjusts the level of the direct sound.

Note: The Gain value is not a dB value.

**02: Compressor**

Compresses the input signal, which can have the effect of suppressing level variation and can make it possible to sustain dampened sounds longer.

**Parameter Value Ranges:**

- 1 :Attack (0 to 127)  
Adjusts the attack amount of the input signal. A smaller value causes prompt compressor operation, which suppresses the attack of the input signal. A larger values delays compressor operation, which causes the attack of the input signal to be output as-is.
- 2 :Release (0 to 127)  
Adjusts the time from the point the input signal drops below a certain level until the compression operation is stopped. When an attack feeling is desired (no compression at the onset of sound), set this parameter to as low a value as possible. To have compression applied at all times, set a high value.
- 3 :Depth (0 to 127)  
Adjusts compression of the audio signal.
- 4 :Wet Level (0 to 127)  
Adjusts the level of the effect sound. Output volume changes in accordance with the Depth setting and the characteristics of the input tone.
- 5 :Dry Level (0 to 127)  
Adjusts the level of the direct sound.

**03: Limiter**

Limits the input signal level so it does not rise above a preset level.

**Parameter Value Ranges:**

- 1 :Limit (0 to 127)  
Adjusts the volume level of the limit at which limiting is applied.
- 2 :Attack (0 to 127)  
Adjusts the attack amount of the input signal.
- 3 :Release (0 to 127)  
Adjusts the time from the point the input signal drops below a certain level until the limit operation is stopped.
- 4 :Wet Level (0 to 127)  
Adjusts the level of the effect sound. Output volume changes in accordance with the Limit setting and the characteristics of the input tone. Use this parameter to correct for such changes.
- 5 :Dry Level (0 to 127)  
Adjusts the level of the direct sound.

**04: Enhancer**

Enhances the profiles of the low range and high range of the input signal.

**Parameter Value Ranges:**

- 1 :Low Frequency (0 to 127)  
Adjusts the low range enhancer frequency.
- 2 :Low Gain (0 to 127)  
Adjusts the low range enhancer gain.
- 3 :High Frequency (0 to 127)  
Adjusts the high range enhancer frequency.
- 4 :High Gain (0 to 127)  
Adjusts the high range enhancer gain.
- 5 :Input Level (0 to 127)  
Adjusts the input level.
- 6 :Wet Level (0 to 127)  
Adjusts the level of the effect sound.
- 7 :Dry Level (0 to 127)  
Adjusts the level of the direct sound.

**05: Early Reflection**

An effector that extracts early reflections from reverb. Applies acoustic presence to notes.

**Parameter Value Ranges:**

- 1 :Wet Level (0 to 127)  
Adjusts the level of the effect sound.
- 2 :Feedback (0 to 127)  
Adjusts the repeat of the reflected sound.
- 3 :Tone (0 to 127)  
Adjusts the tone of the reflected sound.
- 4 :Input Level (0 to 127)  
Adjusts the input level.
- 5 :Dry Level (0 to 127)  
Adjusts the level of the direct sound.

**06: Phaser**

Produces a distinctive pulsating, broad sound by using an LFO to change the phase of the input signal and then mixes it with the original input signal.

**Parameter Value Ranges:**

- 1 :Resonance (0 to 127)  
Adjusts the strength of feedback
- 2 :Manual (-64 to 0 to +63)  
Adjusts the reference phaser shift amount.
- 3 :LFO Rate (0 to 127)  
Adjusts the LFO rate.
- 4 :Depth (0 to 127)  
Adjusts the LFO depth.
- 5 :LFO Waveform (Sin, Tri, Random)  
Selects the LFO waveform.
- 6 :Input Level (0 to 127)  
Adjusts the input level.
- 7 :Wet Level (0 to 127)  
Adjusts the level of the effect sound.
- 8 :Dry Level (0 to 127)  
Adjusts the level of the direct sound.

**07: Chorus**

Gives notes depth and breadth.

**Parameter Value Ranges:**

- 1 :LFO Rate (0 to 127)  
Adjusts the LFO rate.
- 2 :Depth (0 to 127)  
Adjusts the LFO depth.
- 3 :LFO Waveform (Sin, Tri)  
Selects the LFO waveform.
- 4 :Feedback (-64 to 0 to +63)  
Adjusts the strength of feedback
- 5 :Wet Level (0 to 127)  
Adjusts the level of the effect sound.
- 6 :Polarity (-, +)  
Inverts the LFO of one channel.
- 7 :Input Level (0 to 127)  
Adjusts the input level.
- 8 :Dry Level (0 to 127)  
Adjusts the level of the direct sound.

**08: Flanger**

Applies wildly pulsating and metallic reverberation to notes. Selects the LFO waveform.

**Parameter Value Ranges:**

- 1 :LFO Rate (0 to 127)  
Adjusts the LFO rate.
- 2 :Depth (0 to 127)  
Adjusts the LFO depth.
- 3 :LFO Waveform (Sin, Tri, Random)  
Selects the LFO waveform.
- 4 :Feedback (-64 to 0 to +63)  
Adjusts the strength of feedback
- 5 :Wet Level (0 to 127)  
Adjusts the level of the effect sound.
- 6 :Input Level (0 to 127)  
Adjusts the input level.
- 7 :Dry Level (0 to 127)  
Adjusts the level of the direct sound.

**09: Tremolo**

Shifts the volume of the input signal using an LFO.

**Parameter Value Ranges:**

- 1 :LFO Rate (0 to 127)  
Adjusts the LFO rate.
- 2 :Depth (0 to 127)  
Adjusts the LFO depth.
- 3 :LFO Waveform (Sin, Tri, Tra)  
Selects the LFO waveform.
- 4 :Wet Level (0 to 127)  
Adjusts the level of the effect sound.
- 5 :Dry Level (0 to 127)  
Adjusts the level of the direct sound.

**10: Auto Pan**

Shifts the continual left-right panning of the input signal using an LFO.

**Parameter Value Ranges:**

- 1 :LFO Rate (0 to 127)  
Adjusts the LFO rate.
- 2 :Depth (0 to 127)  
Adjusts the LFO depth.
- 3 :LFO Waveform (Sin, Tri, Tra)  
Selects the LFO waveform.
- 4 :Manual (-64 to 0 to +63)  
Adjusts the pan (stereo position). -64 is full left, 0 is center, and +63 is full right.
- 5 :Wet Level (0 to 127)  
Adjusts the level of the effect sound.
- 6 :Dry Level (0 to 127)  
Adjusts the level of the direct sound.

**11: Rotary**

This effect is a rotary speaker simulator.

**Parameter Value Ranges:**

- 1 :Speed (Slow, Fast)  
Switches the speed mode between fast and slow.
- 2 :Brake (Rotate, Stop)  
Stops speaker rotation.
- 3 :Fall Accel (0 to 127)  
Adjusts acceleration when the speed mode is switched from fast to slow.
- 4 :Rise Accel (0 to 127)  
Adjusts acceleration when the speed mode is switched from slow to fast.
- 5 :Slow Rate (0 to 127)  
Adjusts the speaker rotation speed in the slow speed mode.
- 6 :Fast Rate (0 to 127)  
Adjusts the speaker rotation speed in the fast speed mode.
- 7 :Vibrato/Chorus (Off, V1, C1, V2, C2, V3, C3)  
Selects the vibrato (V) and the chorus (C) type.
- 8 :Wet Level (0 to 127)  
Adjusts the level of the effect sound.
- 9 :Dry Level (0 to 127)  
Adjusts the level of the direct sound.

**12: Drive Rotary**

This is a rotary speaker simulator that makes overdrive possible.

**Parameter Value Ranges:**

- 1 :Overdrive Gain (0 to 127)  
Adjusts overdrive gain.
- 2 :Overdrive Level (0 to 127)  
Adjusts the overdrive output level.
- 3 :Speed (Slow, Fast)  
Switches the speed mode between fast and slow.
- 4 :Brake (Rotate, Stop)  
Stops speaker rotation.
- 5 :Fall Accel (0 to 127)  
Adjusts acceleration when the speed mode is switched from fast to slow.
- 6 :Rise Accel (0 to 127)  
Adjusts acceleration when the speed mode is switched from slow to fast.
- 7 :Slow Rate (0 to 127)  
Adjusts the speaker rotation speed in the slow speed mode.
- 8 :Fast Rate (0 to 127)  
Adjusts the speaker rotation speed in the fast speed mode.
- 9 :Vibrato/Chorus (Off, V1, C1, V2, C2, V3, C3)  
Selects the vibrato (V) and chorus (C) type.
- 10:Wet Level (0 to 127)  
Adjusts the level of the effect sound.
- 11:Dry Level (0 to 127)  
Adjusts the level of the direct sound.

**13: LFO Wah**

This is a "wah" effect that can automatically affect the frequency using an LFO.

**Parameter Value Ranges:**

- 1 :Input Level (0 to 127)  
Adjusts the input level. The input signal can become distorted when the level of the sound being input, the number of chords, or the Resonance value is large. Adjust this parameter to eliminate such distortion.
- 2 :Resonance (0 to 127)  
Adjusts the strength of feedback
- 3 :Manual (0 to 127)  
Adjusts the wah filter reference frequency.
- 4 :LFO Rate (0 to 127)  
Adjusts the LFO rate.
- 5 :Depth (0 to 127)  
Adjusts the LFO depth.
- 6 :LFO Waveform (Sin, Tri, Random)  
Selects the LFO waveform.
- 7 :Wet Level (0 to 127)  
Adjusts the level of the effect sound.
- 8 :Dry Level (0 to 127)  
Adjusts the level of the direct sound.

**14: Auto Wah**

This is a "wah" effect that can automatically shift the frequency in accordance with the level of the input signal.

**Parameter Value Ranges:**

- 1 :Input Level (0 to 127)  
Adjusts the input level. The input signal can become distorted when the level of the sound being input, the number of chords, or the Resonance value is large. Adjust this parameter to eliminate such distortion.
- 2 :Resonance (0 to 127)  
Adjusts the strength of feedback
- 3 :Manual (0 to 127)  
Adjusts the wah filter reference frequency.
- 4 :Depth (-64 to 0 to +63)  
Adjusts the depth of the wah in accordance with the level of the input signal.  
Setting a positive value causes the wah filter to open in direct proportion with the size of the input signal, producing a bright sound. Setting a negative value causes the wah filter to close in direct proportion with the size of the input signal, producing a dark sound.
- 5 :Wet Level (0 to 127)  
Adjusts the level of the effect sound.
- 6 :Dry Level (0 to 127)  
Adjusts the level of the direct sound.

**15: Distortion**

Distortion + Wah + Amp Simulator

**Parameter Value Ranges:**

- 1 :Dist Gain (0 to 127)  
Adjusts the distortion input signal gain.
- 2 :Dist Level (0 to 127)  
Adjusts the distortion output level.
- 3 :Dist Low (0 to 127)  
Adjusts the distortion low-range gain.
- 4 :Dist High (0 to 127)  
Adjusts the distortion high-range gain.
- 5 :Wah Depth (-64 to 0 to +63)  
Adjusts the depth of the wah in accordance with the level of the input signal.
- 6 :Wah Manual (0 to 127)  
Adjusts the wah filter reference frequency.
- 7 :Routing (Dist, Wah, Wah-Dist, Dist-Wah)  
Specifies the distortion and wah connection.
- 8 :Amp (Bypass, TCombo, FCombo, ACombo, BCombo, JCombo, MStack, RStack, BassC, BassS)  
Specifies the amp simulation type.
- 9 :Wet Level (0 to 127)  
Adjusts the level of the effect sound.
- 10:Dry Level (0 to 127)  
Adjusts the level of the direct sound.

**16: Pitch Shifter**

This effect transforms the pitch of the input signal.

**Parameter Value Ranges:**

- 1 :Pitch (-24 to 0 to +24)  
Adjusts the pitch shift amount in quarter tone steps.
- 2 :High Damp (0 to 127)  
Adjusts the high-range damp. A smaller number increases damping.
- 3 :Feedback (0 to 127)  
Adjusts the feedback amount.
- 4 :Input Level (0 to 127)  
Adjusts the input level.
- 5 :Wet Level (0 to 127)  
Adjusts the level of the effect sound.
- 6 :Dry Level (0 to 127)  
Adjusts the level of the direct sound.

**17: Multi Chorus**

This is a chorus effect with six different LFO phases.

**Parameter Value Ranges:**

- 1 :LFO Rate (0 to 127)  
Adjusts the LFO rate.
- 2 :Depth (0 to 127)  
Adjusts the LFO depth.
- 3 :Wet Level (0 to 127)  
Adjusts the level of the effect sound.
- 4 :Dry Level (0 to 127)  
Adjusts the level of the direct sound.

**18: Ring Modulator**

Multiplies the input signal with an internal oscillator signal to create a metallic sound.

**Parameter Value Ranges:**

- 1 :OSC frequency (0 to 127)  
Sets the reference frequency of the internal oscillator.
- 2 :LFO Rate (0 to 127)  
Adjusts the LFO rate.
- 3 :Depth (0 to 127)  
Adjusts the LFO depth.
- 4 :Tone (0 to 127)  
Adjusts the timbre of the ring modulator input sound.
- 5 :Wet Level (0 to 127)  
Adjusts the level of the effect sound.
- 6 :Dry Level (0 to 127)  
Adjusts the level of the direct sound.

**19: Delay**

Delays the input signal and feeds it back to create a repeating effect.

**Parameter Value Ranges:**

- 1 :Delay Time (0 to 127)  
Adjusts the total delay time.
- 2 :Delay Ratio L (0 to 127)  
Adjusts the ratio of the left channel relative to the total delay time.
- 3 :Delay Ratio R (0 to 127)  
Adjusts the ratio of the right channel relative to the total delay time.
- 4 :Delay Level L (0 to 127)  
Adjusts the level of the left channel.
- 5 :Delay Level R (0 to 127)  
Adjusts the level of the right channel.
- 6 :Feedback Type (Stereo, Cross)  
Selects the feedback type.  
Stereo: Stereo feedback  
Cross: Cross feedback
- 7 :Feedback (0 to 127)  
Adjusts the feedback amount.
- 8 :High Damp (0 to 127)  
Adjusts the high-range damp. A smaller number increases damping.
- 9 :Delay Tempo Sync (Off, 1/4, 1/3, 3/8, 1/2, 2/3, 3/4, 1)  
Specifies how the actual total delay time is synced with tempo.
  - Off: Uses Delay Time value.
  - 1/4 to 1: Uses value in accordance with number of beats.
- 10:Input Level (0 to 127)  
Adjusts the input level.
- 11: Dry Level (0 to 127)  
Adjusts the level of the direct sound.
- 12:Wet Level (0 to 127)  
Adjusts the level of the effect sound.

**20: Piano Effect**

This effect is suited to acoustic piano play.

**Parameter Value Ranges:**

- 1 :Lid Type (Closed, Semi Opened, Full Opened)  
Adjusts how sound resonates in accordance with the opening state of a piano lid.
- 2 :Reflection Level (0 to 127)  
Adjusts the level of the initial reflection.
- 3 :Input Level (0 to 127)  
Adjusts the input level.
- 4 :Wet Level (0 to 127)  
Adjusts the level of the effect sound.
- 5 :Dry Level (0 to 127)  
Adjusts the level of the direct sound.



## ■ Editable SYSTEM Parameters

- Parts 5 through 16 do not support use of resonance effects.

### System Chorus

Parameter Value Ranges:

- 1 :Type (Light Cho, Chorus, FB Chorus, Flanger)  
Selects the chorus type.
- 2 :LFO Rate (0 to 127)  
Adjusts the LFO rate.
- 3 :LFO Depth (0 to 127)  
Adjusts the LFO depth.
- 4 :Feedback (0 to 127)  
Adjusts the feedback amount.
- 5 :Tone (0 to 127)  
Adjusts the tone.
- 6 :Delay Time (0 to 127)  
Adjusts the delay time.
- 7 :Delay Send (0 to 127)  
Adjust the send level to system delay.
- 8 :Reverb Send (0 to 127)  
Adjust the send level to system reverb.
- 9 :Return (0 to 127)  
Adjusts the return level.

### System Delay

Parameter Value Ranges:

- 1 :Time (0 to 127)  
Adjusts the total delay time.
- 2 :Feedback (0 to 127)  
Adjusts the feedback amount of the center channel.
- 3 :High Damp (0 to 127)  
Adjusts the high-range damp. A smaller number increases damping.
- 4 :Ratio L (0 to 127)  
Adjusts the ratio of the left channel relative to the total delay time.
- 5 :Ratio C (0 to 127)  
Adjusts the ratio of the center channel relative to the total delay time.
- 6 :Ratio R (0 to 127)  
Adjusts the ratio of the right channel relative to the total delay time.
- 7 :Level L (0 to 127)  
Adjusts the level of the left channel.
- 8 :Level C (0 to 127)  
Adjusts the level of the center channel.
- 9 :Level R (0 to 127)  
Adjusts the level of the right channel.
- 10:Tempo Sync (Off, 1/4, 1/3, 3/8, 1/2, 2/3, 3/4, 1, 4/3, 3/2, 2)  
Specifies how the actual total delay time is synced with tempo.
  - Off: Uses Delay Time value.
  - 1/4 to 2: Uses value in accordance with number of beats.
- 11:Reverb Send (0 to 127)  
Adjust the send level to system reverb.
- 12:Return (0 to 127)  
Adjusts the return level.

### System Reverb

Parameter Value Ranges:

- 1 :Type (Room, Hall1, Hall2, Plate)  
Selects the reverb type.
- 2 :Time (0 to 127)  
Adjusts the reverb time.
- 3 :Early Reflection (0 to 127)  
Adjusts the level of the initial reflection.
- 4 :High Damp (0 to 127)  
Adjusts the high-range damp. A smaller number increases damping.
- 5 :Tone (0 to 127)  
Adjusts the tone.
- 6 :Return (0 to 127)  
Adjusts the return level.

## System Resonance

Parameter Value Ranges:

- 1 :String Reso Send (0 to 15)  
Adjusts the send level to string resonance.
- 2 :Damper Reso Send (0 to 15)  
Adjusts the send level to damper resonance.
- 3 :Damper Noise Enable (Off, On)  
Enables/disables the damper noise effect.

## ■ Editable MASTER Parameters

### Master Compressor

Parameter Value Ranges:

- 1 :Threshold (0 to 127)  
Adjusts the threshold (where application of an effect starts) level. Set a lower value for a compressor effect, and a higher value for a limiter effect.
- 2 :Ratio (0 to 127)  
Adjusts the compression ratio. Set a lower value to for a compressor effect, and the maximum value to for a limiter effect.
- 3 :Level (0 to 127)  
Adjusts the output level.
- 4 :Attack (0 to 127)  
Adjusts the time until the compression effect starts. A smaller value causes prompt compressor operation, which suppresses the attack of the input signal. A larger values delays compressor operation, which causes the attack of the input signal to be output as-is.
- 5 :Release (0 to 127)  
Adjusts the release time. Adjusts the time until the compression effect is released.
- 6 :Position (PreEQ, PostEQ)  
Selects the connection position with the compressor and EQ.

### Master Equalizer

Parameter Value Ranges:

- 1 :Low Gain (-12 to 0 to +12)  
Adjusts the low-range gain.
- 2 :Low Frequency (200, 400, 800 [Hz])  
Selects the low-range cutoff frequency.
- 3 :Mid 1 Gain (-12 to 0 to +12)  
Adjusts the low mid-range gain.
- 4 :Mid 1 Frequency (1.0k, 1.3k, 1.6k, 2.0k, 2.5k, 3.2k, 4.0k, 5.0k [Hz])  
Selects the low mid-range frequency.
- 5 :Mid 2 Gain (-12 to 0 to +12)  
Adjusts the high mid-range gain.
- 6 :Mid 2 Frequency (1.0k, 1.3k, 1.6k, 2.0k, 2.5k, 3.2k, 4.0k, 5.0k [Hz])  
Selects the high mid-range frequency.
- 7 :High Gain (-12 to 0 to +12)  
Adjusts the high-range gain.
- 8 :High Frequency (6.0k, 8.0k, 10k [Hz])  
Selects the high-range cutoff frequency.
- 9 :Input Level (0 to 127)  
Adjusts the input level.
- 10:Output Level (0 to 127)  
Adjusts the output level.

# Sounding Arpeggios Automatically (Tutorial)

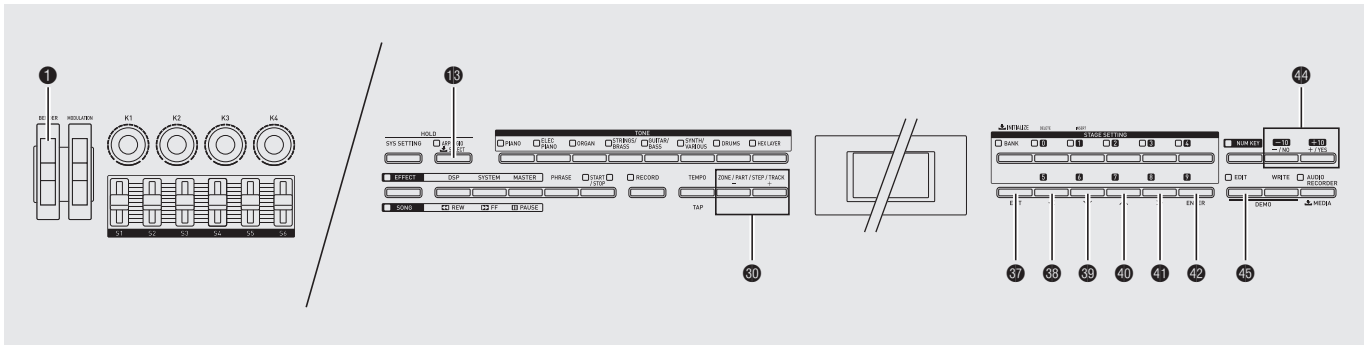

You can edit the Digital Piano's built-in arpeggios to create original arpeggios of your own. You can also record your own original musical phrases for playback in place of arpeggios. After editing an arpeggio, you can give it a name and save it as a user arpeggio.

- The term "key play" means starting playback of a phrase by pressing a keyboard key. With key play, pressing a keyboard key that is the one specified as the phrase's "ORG NOTE" setting will play back the phrase as it was originally recorded. Pressing a keyboard key that is not the one specified as the phrase's "ORG NOTE" setting will shift the pitch of the phrase in accordance with the key that is pressed.

## To play a recorded phrase as an arpeggio

1. Hold down **15** (ARPEGGIO) button until the arpeggio type selection screen shown below appears on the display.

This will cause the button's lamp to light.

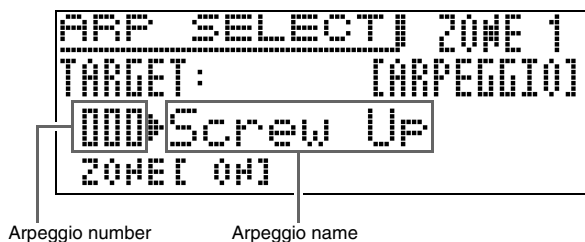

2. Press the **40** (^) button.

This will display the target selection screen (TARGET:ARPEGGIO).

3. Press the **44** plus (+) button.

This will change to the target phrase selection screen (TARGET:PHRASE), and display the currently selected phrase number and phrase name.

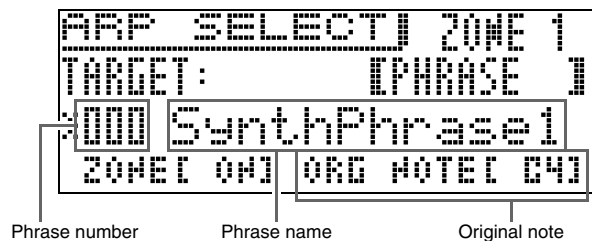

- Note that you cannot perform arpeggio editing while a phrase is selected as the target.

4. Press the **39** (v) button.

This will enter the phrase selection mode, which will cause ▶ to move to the left of the phrase name.

5. Select the phrase number you want.

6. Press the **39** (v) button twice.

This will move [ ] to the original note ("ORG NOTE").

7. Use the **44** minus (-) and plus (+) buttons to specify the original note keyboard key name.

- You can specify a keyboard key name within the range of C- to G9.
- If you want the phrase always to play back as if the keyboard key specified by its "ORG NOTE" setting, regardless of the keyboard key pressed to play it, scroll the selection past G9 and select "Fix".

8. Press keyboard keys and the phrase will play.

## To select a different arpeggio for each zone

1. Hold down the **13 (ARPEGGIO)** button until the arpeggio type selection screen appears on the display.

This will cause the button's lamp to light.

2. Use the **30 (ZONE, +/-)** buttons to display the number of the zone you want to select.

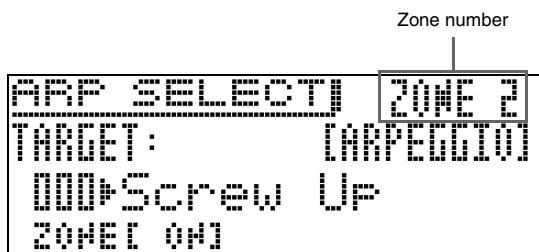

3. After making sure that **▶** is next to the arpeggio number, display the number of the arpeggio you want to select for the zone.

- Repeat steps 2 and 3 as many times as necessary to select arpeggios for each of the zone.

## To turn the arpeggio for a specific zone on or off

1. Hold down the **13 (ARPEGGIO)** button until the arpeggio type selection screen appears on the display.

This will cause the button's lamp to light.

2. Use the **38 (<)**, **39 (∨)**, **40 (∧)**, and **41 (>)** buttons to select "ZONE".

3. Use the **44 (-)** and plus **(+)** buttons to turn the arpeggio of the zone on or off.

### NOTE

- Note that no arpeggio also will play if the zone has been muted. To unmute a zone, press the **37 (EXIT)** button to exit the arpeggio type selection screen, and then press the two **30 (ZONE, +/-)** buttons at the same time.

## Editing an Arpeggio

There are two arpeggio types: step type and variation type.

- With a step type arpeggio, you can edit its steps and its parameters. A step type arpeggio can contain up to 16 steps. You can change the following settings for each step.

**TYPE** : Specifies which note of the arpeggio should be played in each step, in relation to the lowest note (L1) or the highest note (U1) of the arpeggio. There is also a TYPE (P2-P5) that can be used to sound up to five notes at the same time.

**NOTE** : When you want to shift the note from the keyboard key that is pressed, use this setting specify the shift value in semitone steps.

**VELO** : Specifies the volume level.

**CTRL** : This is MIDI control data.

- With a variation type arpeggio, you can edit only its parameters.

1. Select the arpeggio type you want to edit.
2. Press the **45 (EDIT)** button.
3. Use the **39 (∨)** and **40 (∧)** buttons to select "Step Edit" and then press the **42 (ENTER)** button.

- The "Step Edit" option will not be displayed if you selected a variation type arpeggio in step 1, above.



4. Change the TYPE, NOTE, VELO, and CTRL settings as desired.

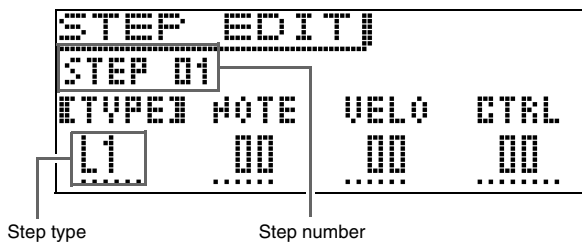

- While **[TYPE]** is selected, use the **44** minus (-) and plus (+) buttons to cycle the TYPE setting between off (Off), on (TYPE) and tie\* (TIE). Note, however, that “STEP 01” does not have a TIE option.
  - \* Selecting TIE extends the duration of the previous step by one step. It can be used to extend the duration of notes.
- NOTE and VELO settings cannot be configured for a step whose TYPE setting is Off or TIE.
- The table below shows the settings on the arpeggio step editing menu.

Menu Level		Description	Setting
1	2		
Step Edit >Ent			
TYPE		Specifies what note of the arpeggio should be played in the currently selected step, in relation to the lowest note (L1) of the keyboard keys pressed. <ul style="list-style-type: none"> <li>• If the value specified for a step is greater than the number of keyboard keys pressed, the corresponding notes of the arpeggio will be played one octave higher. For example, if L4 is specified here, pressing only three keyboard keys will play L1, one octave higher.</li> <li>• After one octave, the corresponding note will return back to the original octave.</li> </ul>	L1 to L8
		Specifies what note of the arpeggio should be played in the currently selected step, in relation to the highest note (U1) of the keyboard keys pressed. <ul style="list-style-type: none"> <li>• If the value specified for a step is greater than the number of keyboard keys pressed, the corresponding notes of the arpeggio will be played one octave lower. For example, if U4 is specified here, pressing only three keyboard keys will play U1, one octave lower.</li> <li>• After one octave, the corresponding note will return back to the original octave.</li> </ul>	U1 to U8
		Specifies what note should be played in the currently selected step, in relation to the highest note of the keyboard keys pressed. <ul style="list-style-type: none"> <li>• If the number of keys pressed is less than the value specified here, the arpeggio is played only up to the keys pressed.</li> </ul>	P2 to P5
NOTE		Specifies a shift of the note sounded, in semitone steps, from the notes of the keys played on keyboard.	-24 - 0 - +24
VELO		Changes the velocity (volume level) of the keyboard keys that are pressed.	-64 - 0 - +63
CTRL		This setting can be used to change the control type value selected with the arpeggio parameter editing menu in step 7 of this procedure, below.	Bend: -128 to 0 to +127, Pan (Control Change 10): -64 to 0 to +63, Control Change 00 to 97 (except for Pan): 0 to 127

5. After the TYPE, NOTE, VELO, and CTRL values are the way you want, press the **37** (EXIT) button to return to the “ARPEGGIO” menu.

6. Use the **39** (∨) and **40** (∧) buttons to move the selection cursor (●) to “Parameter” and then press the **42** (ENTER) button.
7. Change parameters as desired.

- The table below shows the contents of the arpeggio parameter editing menu.

Menu Level		Description	Setting
1	2		
Parameter >Ent			
	Max Step	Maximum step. This parameter can be changed for step type only.	1 - 16
	Step Size	Step size. Specifies the note length between steps.	♪, ♪, ♫, ♫̇, ♫̇, ♫̇, ♫̇
	Note Length	Note length. Note on note length specified as a percentage of the step size. 100% specifies the same size as the original, while 50% specifies a note length that is half the original.	1 - 100%
	Groove	Groove. Specifies the on note timing of the off-beat step. 50% specifies even, while a larger value increases the first half note length.	10 - 90%
	Groove Type	Groove type. Specifies the note length type when anything other than 50% is specified for Groove.	Normal: Playback performed with step length based on actual percentage. Short: When step length is changed, adjusts the step to the shorter length.
	Velocity	Velocity. Specifies the velocity value of an input arpeggio. Specifying “KeyOn” inputs a velocity value in accordance with applied key pressure.	KeyOn, 1 to 127
	Hold Pedal	Hold pedal. Enables/disables hold using a pedal. This parameter can be changed for step type only.	Off, On
	Control Track	Control track. Enables (On) or disables (Off) use of control data. Selecting “Only” causes only the control track to be valid. This parameter can be changed for step type only.	Off, On, Only
	Control Type	Control type. Specifies the control data type. This parameter can be changed for step type only.	Bend, C. (Control Change) 00 - 97
	Smooth	Smooth. Selecting “On” causes control data to be supplemented. This parameter can be changed for step type only.	Off, On

- For information about parameters that need to be edited to playback an arpeggio with a stage setup, see “Using the Stage Setups (Tutorial)” (page E-31).

## Clearing Arpeggio Step Data

Use the procedure below to clear preset step data or step data that was edited using Step Edit (page E-25) and create new step data from scratch.

- Note that the variation type cannot be cleared.

1. While the arpeggio type selection screen is displayed, press the **45 (EDIT)** button.
2. Use the **39 (∨)** and **40 (∧)** buttons to select “Clear Step” and then press the **42 (ENTER)** button.

APP EDIT	1/2*
* Step Edit	>Ent
* Parameter	>Ent
* Clear Step	>Ent

This should cause “Clear?” to appear on the display.

3. Press the **42 (ENTER)** button again.  
This will display a confirmation message (“SURE?”).
4. Press the **44 (YES)** button.  
The message “Complete!” will appear on the display when the data is deleted.

## Renaming an Arpeggio

After editing an arpeggio, you can give it a name and save it as a user arpeggio.

1. Perform steps 1 through 2 of the procedure under “Editing an Arpeggio”, (page E-25).
2. Use the **38 (<)**, **39 (∨)**, **40 (∧)**, and **41 (>)** buttons to select “NameEdit”, and then press the **42 (ENTER)** button.
3. Edit the name as desired.

# Recording and Playing Back Phrases (Tutorial)

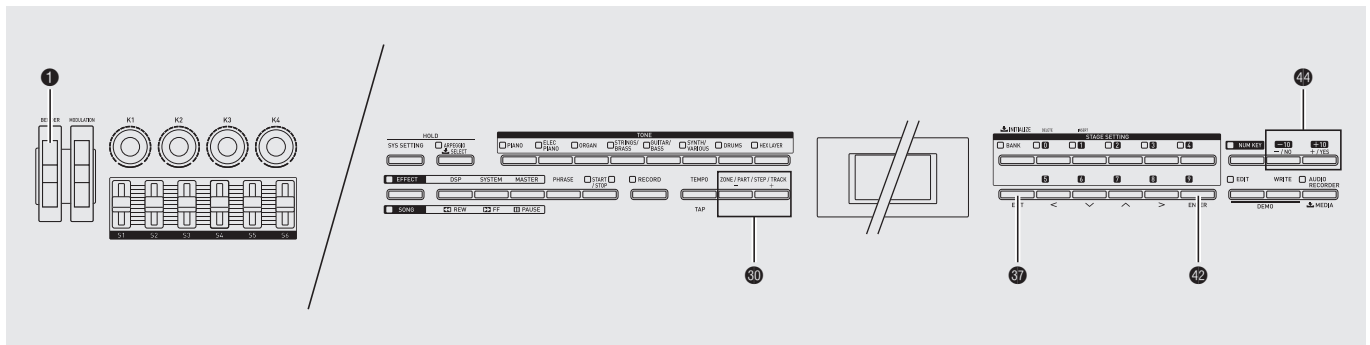

## Recording with the Phrase Sequencer

- The total memory capacity for recording with the phrase sequencer is approximately 1MB. The maximum allowable size of a single phrase is approximately 8KB.
- In addition to what you play on the keyboard, your pedal, wheel, knob, and slider operations are also recorded as part of phrase. However, operations can be recorded when the MIDI channel messages below are assigned to pedals, modulation wheel, knobs, and sliders.
  - CC00 to CC97
  - NRPN
  - RPN
  - Pressure

## Mixer Settings When Playing Back a Song

In addition to the track editing operations described in the USER'S GUIDE (Basics), the song (song sequencer) screen can also be used to edit the settings below.

- Mixer settings when playing back a song
- Changing the tempo when playing back a song
- Clearing a track
- Initializing a song

1. Select the song you want.

## 2. Edit the song as desired.

- To configure mixer settings, select “Song Mixer”.



- The parameters of the mixer settings are described in the table below.

Display Text	Description	Setting
Bank Select MSB	Bank select MSB. Specifies the bank select MSB number. <ul style="list-style-type: none"> <li>To specify a tone on the song mixer screen, specify “Bank Select MSB” and “Program Change” numbers, referring to the “Tone List” at the back of this manual.</li> </ul>	0 - 127
Program Change	Program change. Specifies the program change number. For details, see “Bank Select MSB”, above.	0 - 127
Channel	Specifies the output channel number.	1 - 16
Volume	Volume.	0 - 127
Pan	Panning. Adjusts the left-right position of sound in the stereo field.	-64 - 0 - +63
Coarse Tune	Coarse tune. Shifts the pitch of notes by semitone units.	-24 - 0 - +24
Fine Tune	Fine tune. Shifts the pitch of notes by cent units.	-99 - 0 - +99
Bend Range	Bend range. Specifies (in semitone units) the maximum change in pitch when the <b>1</b> (BENDER) wheel is rotated.	0 - 24
Chorus Send	Chorus send. Specifies how the chorus effect is applied.	0 - 127
Delay Send	Delay send. Specifies how the delay effect is applied.	0 - 127
Reverb Send	Reverb send. Specifies how the reverb effect is applied.	0 - 127
Generator Out	Internal send (Gen Out) on/off. Specifies whether or not to send information about each part to the Digital Piano’s internal sound source.	Off, On
USB Out	USB output (USB Out) on/off. Specifies whether or not MIDI send of the information of each part is performed from <b>49</b> (USB).	Off, On
MIDI Out	MIDI output (MIDI Out) on/off. Specifies whether or not MIDI send of the information of each part is performed from <b>51</b> (MIDI OUT/THRU).	Off, On

### To change the tempo when playing back a song

- Perform steps 1 and 2 of the procedure under “Mixer Settings When Playing Back a Song” (page E-29) to select “Tempo”.
- Adjust the tempo setting.

### To clear a track or initialize a song

- Perform steps 1 and 2 of the procedure under “Mixer Settings When Playing Back a Song” (page E-29) to select the setting you want.
  - To clear a track, select “Track Clear”. Next, on the screen that appears, use the **60** minus (-) and plus (+) buttons to select the track you want to clear.
  - To initialize the song, select “Song Initialize”.
- Press the **42** (ENTER) button.
  - This will display a confirmation message (“SURE?”).
  - If you want to cancel the operation, press the **44** (NO) or **57** (EXIT) button.
- Press the **44** (YES) button.
  - “Complete!” appears on the display after the process is complete.



# Using the Stage Setups (Tutorial)

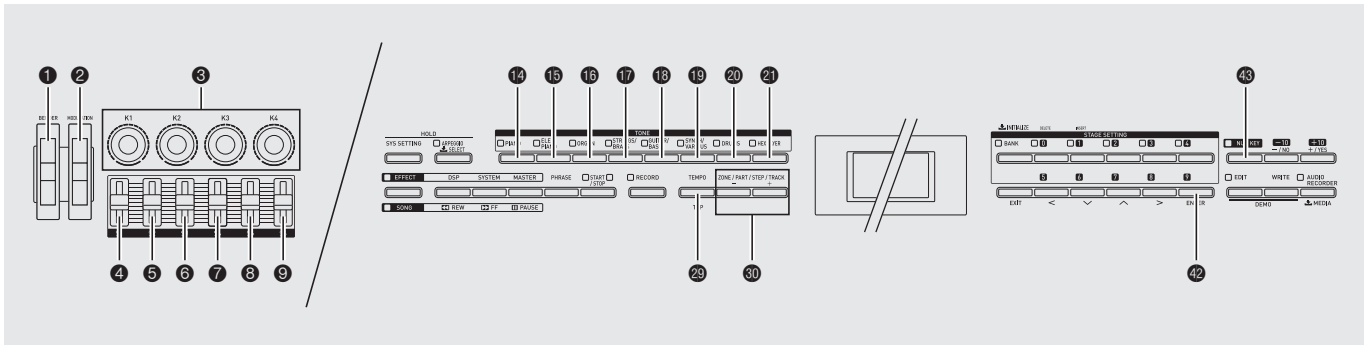

## To edit a stage setup

1. Select the bank and stage setup number you want.
2. Edit the stage setups as desired.
  - The following describes each of the editable parameters.

### Editable Parameters

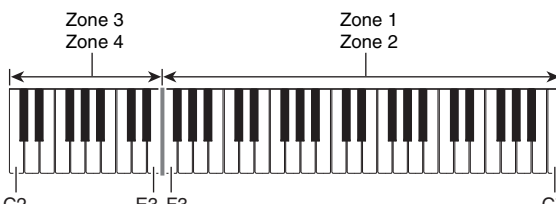
Display Text	Description	Settings
Zone Edit >Ent	Zone parameter edit. This group includes parameters for Zone 1 through 4. <ul style="list-style-type: none"> <li>• Use the <b>30 (ZONE)</b> minus (-) and plus (+) buttons to select the zone you want to edit.</li> </ul>	
Mixer Edit >Ent	Mixer edit. This group includes parameters for the mixer within zones.	
Zone Enable	Zone on/off. Turns all zones on or off. This setting is different from the mixer function part on/off (Part Enable) (page E-37) setting.	Off, On
Tone	Tone. Selects the tone for each zone. This setting is the same as the mixer function part tone (page E-37). Use buttons <b>14</b> through <b>21</b> to switch between tone categories. <ul style="list-style-type: none"> <li>• While this item is selected, you can select a tone using the same operation as that used in the Tone Mode.</li> <li>• The DRM (drums) category cannot be selected for Zone 2. DRM (drums) and HEX (hex layer) cannot be selected for to Zone 3 or Zone 4. Pressing the button of a category that cannot be selected causes the message "Invalid Tone" to be displayed. If this happens, wait until the message disappears or press another category button to clear it.</li> </ul>	PNO (Piano): P00 to U39 EPN (Electric Piano): P000 to U109 ORG (Organ): P00 to U49 STR (Strings, Brass): P00 to U89 GTR (Guitar, Bass): P00 to U59 VAR (Synthesizer, Various): P000 to U129 DRM (Drums): P00 to U39 HEX (Hex Layer): P000 to U199
Key Range Low	Key Range Low. Specifies the low key range of the keyboard for each zone. This setting is used in combination with the Key Range High setting to configure key ranges for each zone. For example, configuring F3 (low) to C7 (high) for Zones 1 and 2, and C2 (low) to E3 (high) for Zones 3 and 4 will enable play of Zone 1 and 2 tones on the right side keyboard range, and the Zone 3 and 4 tones on the left side keyboard in the illustration below.  <ul style="list-style-type: none"> <li>• After pressing the <b>43 (NUM KEY)</b> button to enter the number input mode, you can use the keyboard keys to enter values.</li> </ul>	C - - G9

Display Text	Description	Settings
Key Range High	Key Range High. Specifies the high range of the keyboard for each zone. This setting is used in combination with the Key Range Low setting to configure key ranges for each zone. <ul style="list-style-type: none"> <li>After pressing the <b>43</b> (NUM KEY) button to enter the number input mode, you can use the keyboard keys to enter values.</li> </ul>	C - - G9
Velo.Range Low	Velocity range low. This is the minimum velocity value of each zone. This setting is used in combination with the Velo.Range High setting below to configure velocity ranges for each zone.	0 - 127
Velo.Range High	Velocity range high. This is the maximum velocity value of each zone. This setting is used in combination with the Velo.Range Low setting above to configure velocity ranges for each zone.	0 - 127
Volume	Volume. This setting is the same as the mixer function part volume (page E-37).	0 - 127
Pan	Panning. Adjusts the left-right position of sound in the stereo field. This setting is the same as the mixer function part panning (page E-37).	-64 - 0 - +63
Coarse Tune	Coarse tune. Shifts the pitch of notes by semitone units.	-24 - 0 - +24
Fine Tune	Fine tune. This setting is the same as the mixer function part fine tune (page E-37).	-99 - 0 - +99
Bend Range Down	Bend range down. Pitch change amount for downward bender operation.	0 - 24
Bend Range Up	Bend range up. Pitch change amount for upward bender operation.	0 - 24
Chorus Send	Chorus send. This setting is the same as the mixer chorus send (page E-37).	0 - 127
Delay Send	Delay send. This setting is the same as the mixer delay send (page E-37).	0 - 127
Reverb Send	Reverb send. This setting is the same as the mixer reverb send (page E-37).	0 - 127
Resonance Send	Resonance send. Enables/disables send to the resonance function of each zone.	Off, On
Reso.Return Level	Resonance return level. This setting is the same as the mixer resonance return (page E-37).	0 - 127
Controller Edit >Ent	Controller parameters. This is a group of editable controller parameters.	
Knob1 Enable	Knob 1 on/off (Knob 1 enable). Enables/disables <b>6</b> (K1) operation for each zone.	Off, On
Knob2 Enable	Knob 2 on/off (Knob 2 enable). Enables/disables <b>3</b> (K2) operation for each zone.	Off, On
Knob3 Enable	Knob 3 on/off (Knob 3 enable). Enables/disables <b>6</b> (K3) operation for each zone.	Off, On
Knob4 Enable	Knob 4 on/off (Knob 4 enable). Enables/disables <b>6</b> (K4) operation for each zone.	Off, On
Slider1 Enable	Slider 1 on/off (Slider 1 Enable). Enables/disables <b>4</b> (S1) operation for each zone.	Off, On
Slider2 Enable	Slider 2 on/off (Slider 2 Enable). Enables/disables <b>5</b> (S2) operation for each zone.	Off, On
Slider3 Enable	Slider 3 on/off (Slider 3 Enable). Enables/disables <b>6</b> (S3) operation for each zone.	Off, On
Slider4 Enable	Slider 4 on/off (Slider 4 Enable). Enables/disables <b>7</b> (S4) operation for each zone.	Off, On
Slider5 Enable	Slider 5 on/off (Slider 5 Enable). Enables/disables <b>8</b> (S5) operation for each zone.	Off, On
Slider6 Enable	Slider 6 on/off (Slider 6 Enable). Enables/disables <b>9</b> (S6) operation for each zone.	Off, On
Bender Enable	Bender on/off (bender enable). Enables/disables <b>1</b> (BENDER) operation for each zone.	Off, On
Wheel Enable	Modulation wheel on/off (wheel enable). Enables/disables <b>2</b> (MODULATION) operation for each zone.	Off, On
Pedal1 Enable	Pedal 1 on/off (pedal 1 enable). Enables/disables operation of a pedal connected to <b>50</b> (DAMPER/PEDAL 1) for each Zone.	Off, On

Display Text	Description	Settings
Pedal2 Enable	Pedal 2 on/off (pedal 2 enable). Enables/disables of <b>50 (PEDAL 2)</b> for each zone.	Off, On
Arpeggio Enable	Arpeggio on/off (arpeggio enable). Enables/disables arpeggio function (page E-24) for each zone.	Off, On
Arpeggio Select >Ent	Arpeggio select. This is a group of editable arpeggio function parameters.	
Target	Target. Selects playback of an arpeggio (Arp) or phrase sequencer (Phr) by the arpeggio function. For details, see "To play a recorded phrase as an arpeggio" (page E-24).	Arp, Phr
Arpeggio Number	Arpeggio number. Use this setting to select an arpeggio number (page E-24).	P000 - U199
Arp.Phrase Numb	Arpeggio phrase number. Select the number of the phrase to be played back when the arpeggio target (Target) is "Phrase". For details, see "To play a recorded phrase as an arpeggio" (page E-24).	U000 - U999
Original Key	Original key. Specifies playback in the original key used for recording when performing key play. For details, see "To play a recorded phrase as an arpeggio" (page E-24).	C - - G9, Fix
MIDI Edit >Ent	MIDI parameter. This is a group of MIDI-related (page E-39) editable parameters. Use the <b>30 (ZONE)</b> minus (-), plus (+) buttons to select one of the Digital Piano's 16 sound source parts for editing.	
Octave Shift	Octave shift. Shifts the tone of notes by octave units.	-2 - 0 - +2
Transpose	Transpose. Shifts the pitch of notes by semitone units. This setting is the same as the mixer function part coarse tune (page E-37).	-12 - 0 - +12
External Out Ch	External send channel (external out channel). Specifies the MIDI channel (page E-39) for sending information about each part by MIDI to an external destination.	1 - 16
Generator Out	Internal send (Generator Out) on/off. Specifies whether or not to send information about each part to the Digital Piano's internal sound source.	Off, On
MIDI Out	MIDI output (MIDI Out) on/off. Specifies whether or not MIDI send of the information of each part is performed from <b>51 (MIDI OUT/THRU)</b> .	Off, On
USB Out	USB output (USB Out) on/off. Specifies whether or not MIDI send of the information of each part is performed from <b>49 (USB)</b> .	Off, On
Prog & Bank Out	Program change and bank MSB send on/off. Enables/disables MIDI external send of information about each part from program change (Prg) or bank MSB (Bnk).	Off, Prg, Bnk
PrgBank Edit >Ent	This is a group of program change and bank MSB editable parameters (program change/bank MSB edit). Editing can be performed even when the "ProgBank Out" setting is "Off".	
Bank MSB	Bank MSB. Inputs a program change bank MSB value.	0 - 127
Bank LSB	Bank LSB. Inputs a program change bank LSB value.	0 - 127
Prog.Change	Program change. Inputs a program change value.	1 - 128
System Effect Edit >Ent	System effect parameter. This is a group of editable system effect parameters (page E-18). For details about group items, see "Editable SYSTEM Parameters" (page E-23).	
Chorus Edit >Ent	Chorus edit. This is a group of editable chorus parameters within the system effects.	
Delay Edit >Ent	Delay edit. This is a group of editable delay parameters within the system effects.	
Reverb Edit >Ent	Reverb edit. This is a group of editable reverb parameters within the system effects.	
String Reso Send	String resonance send. Adjusts the send level to string resonance.	0 - 15
Damper Reso Send	Damper resonance send. Adjusts the send level to damper resonance.	0 - 15
Damper Noise Enable	Damper noise enable. Enables/disables the damper noise effect.	Off, On

Display Text	Description	Settings
Master Effect Edit >Ent	Master effect parameter. This is a group of editable master effect parameters (page E-23). For details about group items, see “Editable MASTER Parameters” (page E-23).	
Compressor Edit >Ent	Compressor edit. This is a group of editable compressor parameters within master effects.	
Equalizer Edit >Ent	Equalizer edit. This is a group of editable equalizer parameters within master effects.	
Common Edit >Ent	This is a group of editable pedal, PRN, and NPRN parameters.	
Tempo	Tempo. Adjusts the phrase playback speed. You also can change the phrase playback tempo using the <b>29 (TEMPO)</b> button.	20 - 255
Phrase	Phrase number. Selects the phrase of the Phrase Sequencer (page E-29).	U000 - U999
Arpeggio	Preset arpeggio type selection. See “To use the Arpeggio Function” in the separate USER’S GUIDE (Basics).	Off, On, Hold
Hammer Response	Hammer response. Adjusts hammer response within the range of 0 (fast) to 7 (slow).	0 - 7
Knob1 Edit >Ent	Knob 1 (Knob 1 edit). This is a group of <b>3 (K1)</b> knob editable parameters. Editing can be performed even when the “Knob 1 Enable” setting is “Off”.	
Target	<p>Target. Selects the parameters to be controlled by a controller. For example, the “CC67:Soft” setting specifies a soft pedal effect.</p> <ul style="list-style-type: none"> <li>Two targets can be specified for a single controller. Use the <b>30 (ZONE)</b> minus (-), plus (+) buttons to switch between Target 1 and Target 2.</li> </ul> <p>No Assign: No target specified.  CC00 to CC97: MIDI control change*1  NRPN, RPN: MIDI NRPN and RPN parameters*1 *2  Ch.Pressure: MIDI channel pressure*1  Tempo: Tempo setting (page E-30)  EQ Low Gain - EQ High Gain: Master EQ &gt;Low Gain - High Gain (page E-23)  DSP Bypass: Temporarily bypasses the DSP of the currently selected zone.  Ext. Volume: Control the External Volume value.  Layer Detune: Layer detune (page E-17)  Layer1 Volume - Layer6: Tone parameter settings of each layer</p> <ul style="list-style-type: none"> <li>The following can be assigned: Volume (Volume), Pan (panning), OctShift (octave shift), DspOnOff (DSP on/off), LfoPitch (LFO pitch), LfoFiltr (LFO filter), LfoAmp (LFO amp). For details about each setting, see the editable parameters under “Using Built-in Tones (Tutorial)” on page E-10.</li> </ul> <p>Dsp Param 1-16: DSP parameters  Pedal1 On Rate, Pedal1 Off Rate, Pedal2 On Rate, Pedal2 Off Rate: on value, on rate, off value, off rate for each pedal*3  Arp Hold On/Off: Arpeggio hold setting*4  Song Str/Stp: Song sequencer playback start/stop*4  Phrase Str/Stop: Phrase playback start/stop*4  Audio Str/Stop: Audio playback start/stop*4</p> <p>*1 For details about each setting, see the MIDI Implementation Chart (<a href="http://world.casio.com/">http://world.casio.com/</a>) and/or MIDI documentation.  *2 After selecting these setting items, press the <b>42 (ENTER)</b> button again and then adjust the items below.  MSB: 63H for NRPN, 65H for RPN (Setting range: 000 to 127)  LSB: 62H for NRPN, 64H for RPN (Setting range: 000 to 127)  Send Data: Specifies whether knob operation controls MSB or LSB value. (Settings: MSB, LSB)  *3 This setting is not supported for Damper/Pedal 1 (Pedal 1) or Pedal 2.  *4 This setting is supported for Damper/Pedal 1 (Pedal 1) and Pedal 2 only.</p>	Refer to the cell to the left.
Min Value	Minimum value. Controller minimum output value setting.	0 - 127
Max Value	Maximum value. Controller maximum output value setting.	0 - 127
Knob2-4 Edit >Ent	Knob 2 to 4 (Knob 2 to 4 edit). This is a group of <b>3 (K2)</b> through <b>(K4)</b> editable parameters. Editing can be performed even when the “Knob 2-4 Enable” setting is “Off”. Details of editable parameters are the same as “Knob1 Edit >Ent”, above.	

Display Text	Description	Settings
Slider1-6 Edit >Ent	Slider 1 to 6 edit. This is a group of 4 Slider (S1) through 9 Slider (S6) editable parameters. Editing can be performed even when the "Slider 1-6 Enable" setting is "Off". Details of editable parameters are the same as "Knob1 Edit >Ent", above.	
Modulation Edit >Ent	Modulation wheel (modulation wheel edit). This is a group of 2 (MODULATION) wheel editable parameters. Editing can be performed even when the "Wheel Enable" setting is "Off". Details of editable parameters are the same as "Knob1 Edit >Ent", above.	
Pedal1 Edit >Ent	Damper/Pedal 1 (Pedal1). This is a group of editable parameters for the pedal connected to 50 (DAMPERS/PEDAL 1). Editing can be performed even when the "Pedal1 Enable" setting is "Off".	
Pedal Target Edit >Ent	Specifies the function of the pedal connected to 50 (DAMPERS/PEDAL 1). Details of editable parameters are the same as "Target", above.	
On Rate	On rate. On value change rate.	0 - 127
Off Rate	Off rate. Off value change rate.	0 - 127
Pedal2 Edit >Ent	Pedal2. This is a group of editable parameters for the pedal connected to 50 (PEDAL 2). Editing can be performed even when the "Pedal2 Enable" setting is "Off". Details of editable parameters are the same as "Pedal1 Edit >Ent", above.	

# Other Useful Functions (Tutorial)

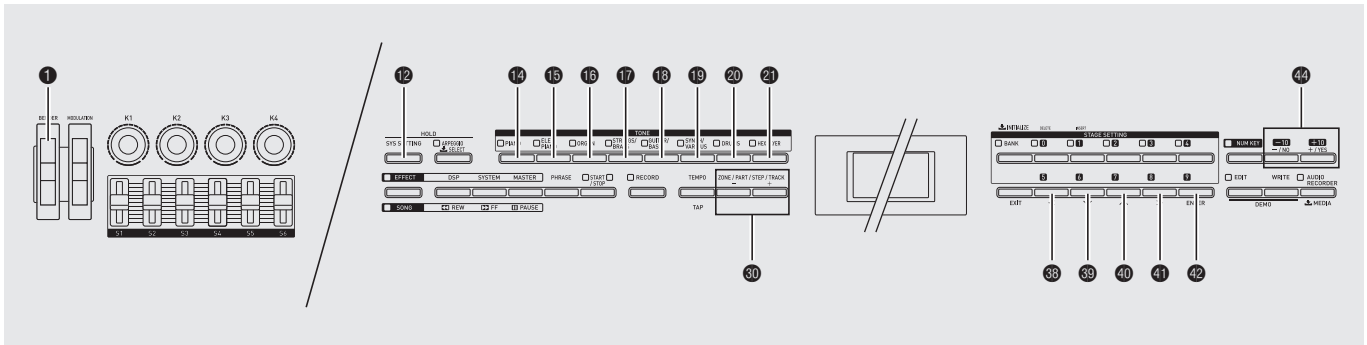

## System Settings

In addition to the system setting screen described in the USER'S GUIDE (Basics), the settings listed below, which also affect Digital Piano global settings, can also be configured.

- Mixer function
- Temperament
- Touch sensitivity adjustment
- Stage setup filter
- MIDI functions
- Digital Piano information (Check of system version in built-in memory, firmware update)

## Using the Mixer

The mixer lets you make adjustments to the tone, volume level, and other settings\* of the Digital Piano's sound source parts (Parts 01 through 16, external input parts, page E-5), while viewing the balance between the parts on the display.

\* Settings that affect individual parts are called "part settings", while settings that affect all parts are called "master settings".

1. Press the **12** (SYS SETTING) button.
2. Use the **38** (<), **39** (∇), **40** (∧), and **41** (>) buttons to select "Sound Generator".



3. Press the **42** (ENTER) button.
4. Change the setting.
  - For information about setting items, see "Setting Items" (page E-37).

5. After settings are the way you want, press the **12** (SYS SETTING) button to exit the setting screen.

## Setting Items

Display Text	Description	Settings																		
Tuning	Tuning. Adjusts, by 0.1 Hertz, the frequency of the A4 note, which is the base note for tuning.	415.5 - 465.9Hz																		
Master Volume	Master volume. Adjusts the volume of all the parts.	0 - 127																		
Master Pan	Master panning (master panning). Adjusts the left-right position of sound in the stereo field of all the parts.	-64 - 0 - +63																		
External Volume	External input volume setting.	0 - 127																		
Mixer Part1-16 >Ent	Mixer Part 1 through Mixer Part 16. These are setting items for Mixer Part 1 through Mixer Part 16. You can also use <b>Ⓟ (PART)</b> minus (-) and plus (+) buttons to select a part.																			
Part Enable	Part on/off (Part Enable). Turns each part on or off.	Off, On																		
Tone	<p>Part tone. This is the tone of each part. Use buttons <b>Ⓛ</b> through <b>Ⓜ</b> to switch between tone categories.</p> <ul style="list-style-type: none"> <li>While this item is selected, you can select a tone using the same operation as that used in the Tone Mode.</li> <li>The DRM (drums) category cannot be selected for Zone 2. DRM (drums) and HEX (hex layer) cannot be selected for to Zone 3 or Zone 4. Pressing the button of a category that cannot be selected causes the message "Invalid Tone" to be displayed. If this happens, wait until the message disappears or press another category button to clear it.</li> </ul>	PNO (Piano): P00 to U39 EPN (Electric Piano): P000 to U109 ORG (Organ): P00 to U49 STR (Strings, Brass): P00 to U89 GTR (Guitar, Bass): P00 to U59 VAR (Synthesizer, Various): P000 to U129 DRM (Drums): P00 to U39 HEX (Hex Layer): P000 to U199																		
Volume	Part volume. This is the volume of each part.	0 - 127																		
Pan	Part panning. Adjusts the left-right position of sound in the stereo field.	-64 - 0 - +63																		
Coarse Tune	Part coarse tune. Shifts the pitch of notes by semitone units.	-24 - 0 - +24																		
Fine Tune	Part fine tune. Shifts the pitch of notes by cent units.	-99 - 0 - +99																		
Bend Range	Part bend range. Specifies (in semitone units) the maximum change in pitch when the <b>Ⓛ</b> (BENDER) wheel is rotated.	0 - 24																		
Chorus Send	Part chorus send. Controls how the chorus effect (page E-18) is applied to each part.	0 - 127																		
Delay Send	Part delay send. Controls how the delay effect (page E-18) is applied to each part.	0 - 127																		
Reverb Send	Part reverb send. Controls how the reverb effect (page E-18) is applied to each part.	0 - 127																		
Resonance Send	Resonance send. Enables/disables send to the resonance function of each mixer part (page E-18). However, note that this setting cannot be changed for Mixer Part 5 and higher.	Off, On																		
Reso.Return Level	Resonance return level. Adjusts the return level of the resonance function for each mixer part. Only certain tones can be edited. Note that this setting cannot be changed for Mixer Part 5 and higher.	0 - 127																		
Temperament >Ent	Temperament. This item specifies the temperament of the internal sound source.																			
Type	<p>Type. One of the 17 temperaments below can be selected.</p> <table border="0"> <tr> <td>00 : Equal</td> <td>09 : Hijaz</td> </tr> <tr> <td>01 : Pure Major</td> <td>10 : Saba</td> </tr> <tr> <td>02 : Pure Minor</td> <td>11 : Dashti</td> </tr> <tr> <td>03 : Pythagorean</td> <td>12 : Chahargah</td> </tr> <tr> <td>04 : Kirnberger 3</td> <td>13 : Segah</td> </tr> <tr> <td>05 : Werckmeister</td> <td>14 : Gurjari Todi</td> </tr> <tr> <td>06 : Mean-Tone</td> <td>15 : Chandrakauns</td> </tr> <tr> <td>07 : Rast</td> <td>16 : Charukeshi</td> </tr> <tr> <td>08 : Bayati</td> <td></td> </tr> </table>	00 : Equal	09 : Hijaz	01 : Pure Major	10 : Saba	02 : Pure Minor	11 : Dashti	03 : Pythagorean	12 : Chahargah	04 : Kirnberger 3	13 : Segah	05 : Werckmeister	14 : Gurjari Todi	06 : Mean-Tone	15 : Chandrakauns	07 : Rast	16 : Charukeshi	08 : Bayati		00 - 16
00 : Equal	09 : Hijaz																			
01 : Pure Major	10 : Saba																			
02 : Pure Minor	11 : Dashti																			
03 : Pythagorean	12 : Chahargah																			
04 : Kirnberger 3	13 : Segah																			
05 : Werckmeister	14 : Gurjari Todi																			
06 : Mean-Tone	15 : Chandrakauns																			
07 : Rast	16 : Charukeshi																			
08 : Bayati																				
Root	Root note (root). Specifies the root note of the temperament.	C - B																		

## Adjusting the Touch Sensitivity

This item is for adjusting how much the sound volume and timbre changes, and how it changes in accordance with keyboard pressure.

1. Press the **12 (SYS SETTING)** button.
2. Use the **38 (<)**, **39 (∇)**, **40 (^)**, and **41 (>)** buttons to select “General”.
3. Press the **42 (ENTER)** button.
4. Use the **38 (<)**, **39 (∇)**, **40 (^)**, and **41 (>)** buttons to select a setting item.

```

GENERAL 2/3
* Panel Lock      Off
* Touch           [Normal]
* Touch Off Velo  [100]
  
```

### Setting Item

Display Text	Description	Settings
Touch	Touch. Specifies touch sensitivity when the keyboard is played. Off: Notes sound at a fixed volume level regardless of keyboard pressure. Light: High-volume notes are easily produced even with light keyboard pressure. Normal Heavy: Normal sound is produced when relatively heavy pressure is applied.	Refer to the cell to the left.
Touch Off Velo	Touch off velocity. Specifies the volume level at which the above touch setting values become off.	1 - 127

5. Change the setting.
6. After settings are the way you want, press the **12 (SYS SETTING)** button to exit the setting screen.

## Stage Setup Filter

Recalling a stage setup causes Digital Piano parameters to be overwritten with the content of the setup. If you create a stage setup filter, the parameters assigned to the filter are not overwritten to be recall of a stage setup, so they retain their current settings.

1. Press the **12 (SYS SETTING)** button.
2. Use the **38 (<)**, **39 (∇)**, **40 (^)**, and **41 (>)** buttons to select “General”.
3. Press the **42 (ENTER)** button.
4. Use the **38 (<)**, **39 (∇)**, **40 (^)**, and **41 (>)** buttons to select “Stage Set Filter”.

```

GENERAL 43/3
# Stage Set Filter >Ent
  
```

5. Press the **42 (ENTER)** button.
6. Use the **39 (∇)** button to select a setting item, and then press the **42 (ENTER)** button.
  - Use the **44** minus (-) and plus (+) buttons to select either “Off” (to allow overwriting of the setting item) or “On” (to disable overwriting of the setting item).

### Setting Item

Display Text	Description	Settings
Tempo	Tempo. When “On” is selected, recall of tempo parameters (page E-34) is disabled.	Off, On
Arpeggio	Arpeggio. When “On” is selected, recall of arpeggio parameters (page E-34) is disabled.	Off, On
Phrase	Phrase. When “On” is selected, recall of phrase parameters (page E-34) is disabled.	Off, On
Hammer Response	Hammer response. When “On” is selected, recall of hammer response parameters (page E-34) is disabled.	Off, On
Chorus	System chorus. When “On” is selected, recall of system chorus parameters (page E-23) is disabled.	Off, On
Delay	System delay. When “On” is selected, recall of system delay parameters (page E-23) is disabled.	Off, On



Display Text	Description	Settings
Reverb	System reverb. When "On" is selected, recall of system reverb parameters (page E-23) is disabled.	Off, On
Compressor	Master compressor. When "On" is selected, recall of master compressor parameters (page E-23) is disabled.	Off, On
Equalizer	Master equalizer. When "On" is selected, recall of master equalizer parameters (page E-23) is disabled.	Off, On
Pedal1	Pedal1. When "On" is selected, recall of Pedal 1 parameters (page E-32) is disabled. <ul style="list-style-type: none"> <li>For Stage Inc and Stage Dec, this operation is always executed, regardless of the stage setting.</li> </ul>	Off, On, Stage Inc, Stage Dec
Pedal2	Pedal2. Settings are the same as Pedal 1, above.	

- 7.** After settings are the way you want, press the **12 (SYS SETTING)** button to exit the setting screen.

## Using MIDI

### What is MIDI?

MIDI is a standard for digital signals and connectors that allows musical instruments, computers, and other devices, regardless of manufacturer, to exchange data with each other.

For details about the MIDI specifications of this Digital Piano, see the "MIDI Implementation" document at the website located at the URL below.

<http://world.casio.com/>

#### NOTE

- Use a separately available or commercially available MIDI cable to connect the MIDI terminals of your Digital Piano and another electronic musical instrument for exchange of MIDI data.
- For information about the relationship between each Digital Keyboard part (page E-36) and the MIDI IN and MIDI OUT channels, see "To edit a stage setup" (page E-31).
- This Digital Piano conforms to General MIDI Level 1 (GM).

### MIDI Settings

- 1.** Press the **12 (SYS SETTING)** button.
- 2.** Select "MIDI>Ent" and then press the **42 (ENTER)** button.
- 3.** Change the setting.

## Setting Item

Display Text	Description	Settings
Transpose	Transpose. Shifts the pitch of notes by semitone units.	-12 - 0 - +12
Octave Shift	Octave shift. Shifts the tone of notes by octave units.	-3 - 0 - +3
Local Control	Local control. Turning off local control disables the Digital Piano's internal sound source, so nothing sound when keyboard keys are pressed. Turn off local control when you want to use the Digital Piano keyboard and pedal operations to operate an external sound source, without producing any sound from the Digital Piano itself.	Off, On
High Reso Out	High-resolution velocity MIDI out on/off.	Off, On
Device ID	Device ID. Selects the ID number of the Digital Piano for MIDI system exclusive message send/receive. <ul style="list-style-type: none"> <li>While "All" is selected, a system exclusive message is sent regardless of the ID number.</li> <li>For details about the ID number, see MIDI Implementation at <a href="http://world.casio.com/">http://world.casio.com/</a>.</li> </ul>	1 - 16, ALL
Basic Ch	Basic channel. Specifies the receive channel of "Stage Set Change", and other MIDI messages described below.	1 - 16
MIDI Out Select	MIDI OUT select. Specifies what is output as MIDI OUT. KEY (Keyboard): Digital Piano keyboard play, operations, etc. MIDI (MIDI IN): Messages input via <b>51</b> (MIDI IN) (MIDI THRU) USB (USB IN): Messages input via <b>49</b> (USB)	Refer to the cell to the left.
USB Out Select	USB out select. Specifies what is output as USB out. KEY (Keyboard): Keyboard and other Digital Piano operations. MIDI (MIDI IN): Messages input via <b>51</b> (MIDI IN)	Refer to the cell to the left.
MIDI In Enable	MIDI IN on/off (MIDI IN enable). While this setting is turned on, messages input via <b>51</b> (MIDI IN) are reflected by the Digital Piano's internal sound source.	Off, On
USB In Enable	USB IN on/off (USB IN enable). While this setting is turned on, messages input via <b>49</b> (USB) are reflected by the Digital Piano's internal sound source.	Off, On
Sync Mode	Sync mode. Settings for MIDI syncing between the Digital Piano and an external device. Off: No syncing. Master: Outputs Clock, Start/Stop (Song Sequencer), and other signals from the Digital Piano to control an external device. Slave: Receives Clock, Start/Stop, and other signals from an external device. <ul style="list-style-type: none"> <li>Song sequencer playback cannot be performed if a clock is not received. Start/stop is regarded as song sequencer operation.</li> </ul>	Refer to the cell to the left.
Stage Set.Chg	Stage setup change. PrgBnk: Program Change Bank = 70H. Also output when this operation is performed. NRPN: Select by NRPN MSB = 24H, LSB = 00H. Also output when this operation is performed.	PrgBnk, NRPN

4. After settings are the way you want, press the **12 (SYS SETTING)** button to exit the setting screen.

#### NOTE

- You can also use stage setup editing to change the MIDI data send channel and configure other settings. For more information, see the “MIDI Edit >Ent” group (page E-33).

## Digital Piano Information

You can use the system setting information (Information) screen to check the version of the system loaded in Digital Piano memory, and to update the firmware.

1. Press the **12 (SYS SETTING)** button.
2. Use the **38 (<)**, **39 (∨)**, **40 (^)**, and **41 (>)** buttons to select “Information”.

SYS.SETTINGS	2/2
* General	>Ent
* Initialize	>Ent
* Information	>Ent

3. Press the **42 (ENTER)** button.
4. Use the **39 (∨)** button to select a setting item, and then press the **42 (ENTER)** button.
 

Version: Checks the version of the system in Digital Piano memory.

  - This is only a check, so there are no settings.
  - Update Firmware: Updates the firmware.
  - For information about the latest firmware and how to update, visit the website below.  
<http://world.casio.com/>
5. After settings are the way you want, press the **12 (SYS SETTING)** button to exit the setting screen.

# Reference

## Tone List

Group Name	Number	Tone Name	Screen Name	Sending and Receiving		Receiving Only	
				Program Change	Bank Select MSB	Program Change	Bank Select MSB
PIANO	000	GRAND PIANO CONCERT	GrPnoConcert	0	64	0	48
PIANO	001	ROCK PIANO	Rock Piano	1	64	1	48
PIANO	002	GRAND PIANO STUDIO	GrPno Studio	2	64	0	54
PIANO	003	GRAND PIANO MODERN	GrPno Modern	3	64	0	49
PIANO	004	LA PIANO	LA Piano	4	64	1	49
PIANO	005	DANCE PIANO	Dance Piano	5	64	1	50
PIANO	006	GRAND PIANO BRIGHT	GrPno Bright	6	64	1	51
PIANO	007	GRAND PIANO MELLOW	GrPno Mellow	7	64	0	51
PIANO	008	MONO PIANO 1	Mono Piano 1	8	64	0	56
PIANO	009	MONO PIANO 2	Mono Piano 2	9	64	0	57
PIANO	010	TACK PIANO	Tack Piano	10	64	0	58
PIANO	011	GRAND PIANO CLASSIC	GrPnoClassic	11	64	0	50
PIANO	012	GRAND PIANO DOLCE	GrPianoDolce	12	64	0	55
PIANO	013	HONKY-TONK	Honky-Tonk	13	64	3	48
PIANO	014	OCTAVE PIANO	Octave Piano	14	64	3	49
PIANO	015	STRINGS PIANO	StringsPiano	15	64	0	52
PIANO	016	PIANO PAD	Piano Pad	16	64	0	53
PIANO	017	GM PIANO 1	GM Piano 1	17	64	0	0
PIANO	018	GM PIANO 2	GM Piano 2	18	64	1	0
PIANO	019	GM HONKY-TONK	GM HonkyTonk	19	64	3	0
PIANO	020 - 039	User Tones		20 - 39	64		
ELEC PIANO	000	AiR ELEC.PIANO 1	AiR E.Piano1	0	65	4	40
ELEC PIANO	001	AiR ELEC.PIANO 2	AiR E.Piano2	1	65	4	41
ELEC PIANO	002	AiR ELEC.PIANO 3	AiR E.Piano3	2	65	4	42
ELEC PIANO	003	AiR ELEC.PIANO 4	AiR E.Piano4	3	65	4	43
ELEC PIANO	004	AiR ELEC.PIANO 5	AiR E.Piano5	4	65	4	44
ELEC PIANO	005	AiR 60'S E.PIANO 1	AiR 60's EP1	5	65	4	45
ELEC PIANO	006	AiR 60'S E.PIANO 2	AiR 60's EP2	6	65	4	46
ELEC PIANO	007	AiR 60'S E.PIANO 3	AiR 60's EP3	7	65	4	47
ELEC PIANO	008	AiR 60'S E.PIANO 4	AiR 60's EP4	8	65	4	48
ELEC PIANO	009	ELEC.PIANO 1	Elec.Piano 1	9	65	4	49
ELEC PIANO	010	ELEC.PIANO 2	Elec.Piano 2	10	65	4	50
ELEC PIANO	011	ELEC.PIANO 3	Elec.Piano 3	11	65	4	51
ELEC PIANO	012	ELEC.PIANO 4	Elec.Piano 4	12	65	4	52
ELEC PIANO	013	ELEC.PIANO 5	Elec.Piano 5	13	65	4	53
ELEC PIANO	014	DIGITAL E.PIANO 1	Digital EP 1	14	65	5	48
ELEC PIANO	015	DIGITAL E.PIANO 2	Digital EP 2	15	65	5	49
ELEC PIANO	016	DIGITAL E.PIANO 3	Digital EP 3	16	65	5	50
ELEC PIANO	017	DIGITAL E.PIANO 4	Digital EP 4	17	65	5	51
ELEC PIANO	018	DIGITAL E.PIANO 5	Digital EP 5	18	65	5	52
ELEC PIANO	019	DIGITAL E.PIANO 6	Digital EP 6	19	65	5	53
ELEC PIANO	020	DIGITAL E.PIANO 7	Digital EP 7	20	65	5	54
ELEC PIANO	021	DIGITAL E.PIANO 8	Digital EP 8	21	65	5	55
ELEC PIANO	022	DIGITAL E.PIANO 9	Digital EP 9	22	65	5	56
ELEC PIANO	023	DYNO ELEC.PIANO 1	DynoE.Piano1	23	65	4	54
ELEC PIANO	024	DYNO ELEC.PIANO 2	DynoE.Piano2	24	65	4	55
ELEC PIANO	025	60'S ELEC.PIANO 1	60'sE.Piano1	25	65	4	56
ELEC PIANO	026	60'S ELEC.PIANO 2	60'sE.Piano2	26	65	4	57
ELEC PIANO	027	PHASER E.PIANO 1	Phaser EP 1	27	65	4	58
ELEC PIANO	028	PHASER E.PIANO 2	Phaser EP 2	28	65	4	59

Group Name	Number	Tone Name	Screen Name	Sending and Receiving		Receiving Only	
				Program Change	Bank Select MSB	Program Change	Bank Select MSB
ELEC PIANO	029	AMP E.PIANO 1	Amp E.Piano1	29	65	4	60
ELEC PIANO	030	AMP E.PIANO 2	Amp E.Piano2	30	65	4	61
ELEC PIANO	031	CRUNCH E.PIANO	Crunch EP	31	65	4	62
ELEC PIANO	032	DIZZY E.PIANO	Dizzy EP	32	65	4	63
ELEC PIANO	033	ANALOG E.PIANO 1	Analog EP 1	33	65	5	57
ELEC PIANO	034	ANALOG E.PIANO 2	Analog EP 2	34	65	5	58
ELEC PIANO	035	OFF VELO.CLAVI 1	OffVelClavi1	35	65	7	48
ELEC PIANO	036	OFF VELO.CLAVI 2	OffVelClavi2	36	65	7	49
ELEC PIANO	037	CLAVI 1	Clavi 1	37	65	7	50
ELEC PIANO	038	CLAVI 2	Clavi 2	38	65	7	51
ELEC PIANO	039	CLAVI 3	Clavi 3	39	65	7	52
ELEC PIANO	040	CLAVI 4	Clavi 4	40	65	7	53
ELEC PIANO	041	WAH CLAVI 1	Wah Clavi 1	41	65	7	54
ELEC PIANO	042	WAH CLAVI 2	Wah Clavi 2	42	65	7	55
ELEC PIANO	043	CRUNCH CLAVI	Crunch Clavi	43	65	7	56
ELEC PIANO	044	OFF VELO.HARPSICHORD	OffVelHarpis	44	65	6	48
ELEC PIANO	045	HARPSICHORD	Harpsichord	45	65	6	49
ELEC PIANO	046	COUPLED HARPSICHORD	Coupl.Harpis	46	65	6	50
ELEC PIANO	047	VIBRAPHONE	Vibraphone	47	65	11	48
ELEC PIANO	048	GM E.PIANO 1	GM E.Piano 1	48	65	4	0
ELEC PIANO	049	GM E.PIANO 2	GM E.Piano 2	49	65	5	0
ELEC PIANO	050	GM ELEC.GRAND PIANO	GM E.G.Piano	50	65	2	0
ELEC PIANO	051	GM HARPSICHORD	GM Harpsi.	51	65	6	0
ELEC PIANO	052	GM CLAVI	GM Clavi	52	65	7	0
ELEC PIANO	053	GM CELESTA	GM Celesta	53	65	8	0
ELEC PIANO	054	GM GLOCKENSPIEL	GM Glocken.	54	65	9	0
ELEC PIANO	055	GM MUSIC BOX	GM Music Box	55	65	10	0
ELEC PIANO	056	GM VIBRAPHONE	GM Vibraphon	56	65	11	0
ELEC PIANO	057	GM MARIMBA	GM Marimba	57	65	12	0
ELEC PIANO	058	GM XYLOPHONE	GM Xylophone	58	65	13	0
ELEC PIANO	059	GM TUBULAR BELL	GM TublarBel	59	65	14	0
ELEC PIANO	060 - 109	User Tones		60 - 109	65		
ORGAN	000	ROCK ORGAN 1	Rock Organ 1	0	66	16	49
ORGAN	001	ROCK ORGAN 2	Rock Organ 2	1	66	18	48
ORGAN	002	ROCK ORGAN 3	Rock Organ 3	2	66	18	49
ORGAN	003	JAZZ ORGAN 1	Jazz Organ 1	3	66	17	48
ORGAN	004	JAZZ ORGAN 2	Jazz Organ 2	4	66	17	51
ORGAN	005	PERC.ORGAN 1	Perc.Organ 1	5	66	17	49
ORGAN	006	PERC.ORGAN 2	Perc.Organ 2	6	66	17	52
ORGAN	007	PERC.ORGAN 3	Perc.Organ 3	7	66	17	53
ORGAN	008	DRAWBAR ORGAN 1	Drawbar Org1	8	66	16	48
ORGAN	009	DRAWBAR ORGAN 2	Drawbar Org2	9	66	16	50
ORGAN	010	DRAWBAR ORGAN 3	Drawbar Org3	10	66	16	51
ORGAN	011	ELEC.ORGAN 1	Elec.Organ 1	11	66	16	54
ORGAN	012	ELEC.ORGAN 2	Elec.Organ 2	12	66	16	55
ORGAN	013	ELEC.ORGAN 3	Elec.Organ 3	13	66	16	56
ORGAN	014	70'S ORGAN	70's Organ	14	66	17	50
ORGAN	015	OVERDRIVE ORGAN 1	OverdrivOrg1	15	66	16	52
ORGAN	016	OVERDRIVE ORGAN 2	OverdrivOrg2	16	66	16	57
ORGAN	017	TREMOLO ORGAN	Tremolo Org	17	66	16	53
ORGAN	018	CLICK ORGAN	Click Organ	18	66	17	54
ORGAN	019	SEQUENCE ORGAN	Seq.Organ	19	66	17	55
ORGAN	020	GOSPEL ORGAN	Gospel Organ	20	66	17	56
ORGAN	021	CHAPEL ORGAN	Chapel Organ	21	66	19	49

Group Name	Number	Tone Name	Screen Name	Sending and Receiving		Receiving Only	
				Program Change	Bank Select MSB	Program Change	Bank Select MSB
ORGAN	022	GM ORGAN 1	GM Organ 1	22	66	16	0
ORGAN	023	GM ORGAN 2	GM Organ 2	23	66	17	0
ORGAN	024	GM ORGAN 3	GM Organ 3	24	66	18	0
ORGAN	025	GM PIPE ORGAN	GM PipeOrgan	25	66	19	0
ORGAN	026	GM REED ORGAN	GM ReedOrgan	26	66	20	0
ORGAN	027	GM ACCORDION	GM Accordion	27	66	21	0
ORGAN	028	GM HARMONICA	GM Harmonica	28	66	22	0
ORGAN	029	GM BANDONEON	GM Bandoneon	29	66	23	0
ORGAN	030 - 049	User Tones	User 90	30 - 49	66		
STRINGS/ BRASS	000	STEREO STRINGS 1	StreoString1	0	67	49	48
STRINGS/ BRASS	001	STEREO STRINGS 2	StreoString2	1	67	48	49
STRINGS/ BRASS	002	STRING ENSEMBLE	String Ens.	2	67	48	48
STRINGS/ BRASS	003	SLOW STRINGS	Slow Strings	3	67	49	49
STRINGS/ BRASS	004	BRIGHT STRINGS	BriteStrings	4	67	48	50
STRINGS/ BRASS	005	WARM STRINGS	Warm Strings	5	67	48	51
STRINGS/ BRASS	006	SYNTH-STRINGS 1	Syn-Strings1	6	67	50	48
STRINGS/ BRASS	007	SYNTH-STRINGS 2	Syn-Strings2	7	67	51	48
STRINGS/ BRASS	008	SYNTH-STRINGS 3	Syn-Strings3	8	67	51	49
STRINGS/ BRASS	009	70'S SYNTH-STR.	70's Syn-Str	9	67	50	49
STRINGS/ BRASS	010	80'S SYNTH-STR.	80's Syn-Str	10	67	50	50
STRINGS/ BRASS	011	VIOLIN SECTION	ViolnSection	11	67	40	48
STRINGS/ BRASS	012	ORCHESTRA PAD	OrchestraPad	12	67	48	52
STRINGS/ BRASS	013	CHOIR	Choir	13	67	52	48
STRINGS/ BRASS	014	SYNTH-VOICE 1	Synth-Voice1	14	67	54	48
STRINGS/ BRASS	015	SYNTH-VOICE 2	Synth-Voice2	15	67	54	49
STRINGS/ BRASS	016	VOICE ENSEMBLE	VoiceEnsembl	16	67	54	50
STRINGS/ BRASS	017	SYNTH-VOICE PAD	SynVoice Pad	17	67	54	51
STRINGS/ BRASS	018	STEREO BRASS	Stereo Brass	18	67	61	48
STRINGS/ BRASS	019	BRASS SECTION	BrassSection	19	67	61	49
STRINGS/ BRASS	020	SYNTH-BRASS 1	Syn-Brass 1	20	67	62	48
STRINGS/ BRASS	021	SYNTH-BRASS 2	Syn-Brass 2	21	67	63	48
STRINGS/ BRASS	022	80'S SYNTH-BRASS	80'sSynBrass	22	67	62	49
STRINGS/ BRASS	023	BRASS ENSEMBLE	Brass Ens.	23	67	61	50
STRINGS/ BRASS	024	BREATHY ALTO SAX	Breathy ASax	24	67	65	49
STRINGS/ BRASS	025	BREATHY TENOR SAX	Breathy TSax	25	67	66	49
STRINGS/ BRASS	026	ALTO SAX	Alto Sax	26	67	65	48
STRINGS/ BRASS	027	TENOR SAX	Tenor Sax	27	67	66	48
STRINGS/ BRASS	028	FLUTE	Flute	28	67	73	48
STRINGS/ BRASS	029	TRUMPET	Trumpet	29	67	56	48
STRINGS/ BRASS	030	GM VIOLIN	GM Violin	30	67	40	0
STRINGS/ BRASS	031	GM VIOLA	GM Viola	31	67	41	0
STRINGS/ BRASS	032	GM CELLO	GM Cello	32	67	42	0
STRINGS/ BRASS	033	GM CONTRABASS	GM Contrabas	33	67	43	0
STRINGS/ BRASS	034	GM TREMOLO STRINGS	GM Trem.Str.	34	67	44	0
STRINGS/ BRASS	035	GM PIZZICATO	GM Pizzicato	35	67	45	0
STRINGS/ BRASS	036	GM HARP	GM Harp	36	67	46	0
STRINGS/ BRASS	037	GM TIMPANI	GM Timpani	37	67	47	0
STRINGS/ BRASS	038	GM STRINGS 1	GM Strings 1	38	67	48	0
STRINGS/ BRASS	039	GM STRINGS 2	GM Strings 2	39	67	49	0
STRINGS/ BRASS	040	GM SYNTH-STRINGS 1	GM Syn-Str.1	40	67	50	0
STRINGS/ BRASS	041	GM SYNTH-STRINGS 2	GM Syn-Str.2	41	67	51	0
STRINGS/ BRASS	042	GM CHOIR AAHS	GM ChoirAahs	42	67	52	0

Group Name	Number	Tone Name	Screen Name	Sending and Receiving		Receiving Only	
				Program Change	Bank Select MSB	Program Change	Bank Select MSB
STRINGS/ BRASS	043	GM VOICE DOO	GM Voice Doo	43	67	53	0
STRINGS/ BRASS	044	GM SYNTH-VOICE	GM Syn-Voice	44	67	54	0
STRINGS/ BRASS	045	GM ORCHESTRA HIT	GM Orch.Hit	45	67	55	0
STRINGS/ BRASS	046	GM TRUMPET	GM Trumpet	46	67	56	0
STRINGS/ BRASS	047	GM TROMBONE	GM Trombone	47	67	57	0
STRINGS/ BRASS	048	GM TUBA	GM Tuba	48	67	58	0
STRINGS/ BRASS	049	GM MUTE TRUMPET	GM MtTrumpet	49	67	59	0
STRINGS/ BRASS	050	GM FRENCH HORN	GM Fr.Horn	50	67	60	0
STRINGS/ BRASS	051	GM BRASS	GM Brass	51	67	61	0
STRINGS/ BRASS	052	GM SYNTH-BRASS 1	GM SynBrass1	52	67	62	0
STRINGS/ BRASS	053	GM SYNTH-BRASS 2	GM SynBrass2	53	67	63	0
STRINGS/ BRASS	054	GM SOPRANO SAX	GM Sop.Sax	54	67	64	0
STRINGS/ BRASS	055	GM ALTO SAX	GM Alto Sax	55	67	65	0
STRINGS/ BRASS	056	GM TENOR SAX	GM Tenor Sax	56	67	66	0
STRINGS/ BRASS	057	GM BARITONE SAX	GM Bar.Sax	57	67	67	0
STRINGS/ BRASS	058	GM OBOE	GM Oboe	58	67	68	0
STRINGS/ BRASS	059	GM ENGLISH HORN	GM Eng.Horn	59	67	69	0
STRINGS/ BRASS	060	GM BASSOON	GM Bassoon	60	67	70	0
STRINGS/ BRASS	061	GM CLARINET	GM Clarinet	61	67	71	0
STRINGS/ BRASS	062	GM PICCOLO	GM Piccolo	62	67	72	0
STRINGS/ BRASS	063	GM FLUTE	GM Flute	63	67	73	0
STRINGS/ BRASS	064	GM RECORDER	GM Recorder	64	67	74	0
STRINGS/ BRASS	065	GM PAN FLUTE	GM Pan Flute	65	67	75	0
STRINGS/ BRASS	066	GM BOTTLE BLOW	GM BotleBlow	66	67	76	0
STRINGS/ BRASS	067	GM SHAKUHACHI	GM Shakuhach	67	67	77	0
STRINGS/ BRASS	068	GM WHISTLE	GM Whistle	68	67	78	0
STRINGS/ BRASS	069	GM OCARINA	GM Ocarina	69	67	79	0
STRINGS/ BRASS	070 - 089	User Tones		70 - 89	67		
GIUITAR/ BASS	000	ACOUSTIC BASS 1	Acous.Bass 1	0	68	32	48
GIUITAR/ BASS	001	ACOUSTIC BASS 2	Acous.Bass 2	1	68	32	49
GIUITAR/ BASS	002	RIDE BASS	Ride Bass	2	68	32	50
GIUITAR/ BASS	003	FINGERED BASS 1	FingerBass 1	3	68	33	48
GIUITAR/ BASS	004	FINGERED BASS 2	FingerBass 2	4	68	33	49
GIUITAR/ BASS	005	FINGERED BASS 3	FingerBass 3	5	68	34	50
GIUITAR/ BASS	006	PICKED BASS	Picked Bass	6	68	34	48
GIUITAR/ BASS	007	SYNTH-BASS 1	Synth-Bass 1	7	68	38	48
GIUITAR/ BASS	008	SYNTH-BASS 2	Synth-Bass 2	8	68	38	49
GIUITAR/ BASS	009	SYNTH-BASS 3	Synth-Bass 3	9	68	38	50
GIUITAR/ BASS	010	SYNTH-BASS 4	Synth-Bass 4	10	68	39	48
GIUITAR/ BASS	011	SYNTH-BASS 5	Synth-Bass 5	11	68	39	49
GIUITAR/ BASS	012	SYNTH-BASS 6	Synth-Bass 6	12	68	39	50
GIUITAR/ BASS	013	TRANCE BASS	Trance Bass	13	68	38	51
GIUITAR/ BASS	014	NYLON STR.GUITAR	Nylon Guitar	14	68	24	48
GIUITAR/ BASS	015	STEEL STR.GUITAR	Steel Guitar	15	68	25	48
GIUITAR/ BASS	016	JAZZ GUITAR	Jazz Guitar	16	68	26	48
GIUITAR/ BASS	017	CLEAN GUITAR	Clean Guitar	17	68	27	49
GIUITAR/ BASS	018	CHORUS CLEAN GUITAR	Cho.CleanGt	18	68	27	48
GIUITAR/ BASS	019	CRUNCH ELEC.GUITAR	Crunch E.Gt	19	68	27	50

Group Name	Number	Tone Name	Screen Name	Sending and Receiving		Receiving Only	
				Program Change	Bank Select MSB	Program Change	Bank Select MSB
GIUITAR/BASS	020	OVERDRIVE GUITAR 1	Overdrive Gt	20	68	29	48
GIUITAR/BASS	021	MUTE OVERDRIVE GT	Mute Ovd Gt	21	68	28	48
GIUITAR/BASS	022	OVERDRIVE GUITAR 2	Overdrive G2	22	68	28	49
GIUITAR/BASS	023	DISTORTION GT	DistortionGt	23	68	30	48
GIUITAR/BASS	024	GM NYLON STR.GUITAR	GM Nylon Gt	24	68	24	0
GIUITAR/BASS	025	GM STEEL STR.GUITAR	GM Steel Gt	25	68	25	0
GIUITAR/BASS	026	GM JAZZ GUITAR	GM Jazz Gt	26	68	26	0
GIUITAR/BASS	027	GM CLEAN GUITAR	GM Clean Gt	27	68	27	0
GIUITAR/BASS	028	GM MUTE GUITAR	GM Mute Gt	28	68	28	0
GIUITAR/BASS	029	GM OVERDRIVE GT	GM Overdrive	29	68	29	0
GIUITAR/BASS	030	GM DISTORTION GT	GM Dist.Gt	30	68	30	0
GIUITAR/BASS	031	GM GT HARMONICS	GM Gt Harm.	31	68	31	0
GIUITAR/BASS	032	GM ACOUSTIC BASS	GM AcousBass	32	68	32	0
GIUITAR/BASS	033	GM FINGERED BASS	GM Finger Bs	33	68	33	0
GIUITAR/BASS	034	GM PICKED BASS	GM Pick Bass	34	68	34	0
GIUITAR/BASS	035	GM FRETLESS BASS	GM FretlesBs	35	68	35	0
GIUITAR/BASS	036	GM SLAP BASS 1	GM SlapBass1	36	68	36	0
GIUITAR/BASS	037	GM SLAP BASS 2	GM SlapBass2	37	68	37	0
GIUITAR/BASS	038	GM SYNTH-BASS 1	GM Syn-Bass1	38	68	38	0
GIUITAR/BASS	039	GM SYNTH-BASS 2	GM Syn-Bass2	39	68	39	0
GIUITAR/BASS	040 - 059	User Tones		40 - 59	68		
SYNTH/ VARIOUS	000	SAW LEAD 1	Saw Lead 1	0	69	81	48
SYNTH/ VARIOUS	001	SAW LEAD 2	Saw Lead 2	1	69	81	49
SYNTH/ VARIOUS	002	SAW LEAD 3	Saw Lead 3	2	69	81	50
SYNTH/ VARIOUS	003	MELLOW SAW LEAD	MelowSawLead	3	69	81	51
SYNTH/ VARIOUS	004	SQUARE LEAD 1	Square Lead1	4	69	80	48
SYNTH/ VARIOUS	005	SQUARE LEAD 2	Square Lead2	5	69	80	49
SYNTH/ VARIOUS	006	PULSE LEAD 1	Pulse Lead 1	6	69	80	51
SYNTH/ VARIOUS	007	PULSE LEAD 2	Pulse Lead 2	7	69	80	52
SYNTH/ VARIOUS	008	SINE LEAD	Sine Lead	8	69	80	53
SYNTH/ VARIOUS	009	SQUARE PULSE LEAD	Sqr Pulse Ld	9	69	80	59
SYNTH/ VARIOUS	010	VA SYNTH 1	VA Synth 1	10	69	80	54
SYNTH/ VARIOUS	011	VA SYNTH 2	VA Synth 2	11	69	80	55
SYNTH/ VARIOUS	012	VA SYNTH 3	VA Synth 3	12	69	80	56
SYNTH/ VARIOUS	013	VA SYNTH 4	VA Synth 4	13	69	80	57
SYNTH/ VARIOUS	014	VA SYNTH 5	VA Synth 5	14	69	80	58
SYNTH/ VARIOUS	015	SEQUENCE SAW	Sequence Saw	15	69	81	55
SYNTH/ VARIOUS	016	SAW ARPEGGIO	Saw Arpeggio	16	69	81	56
SYNTH/ VARIOUS	017	VA SYNTH SEQ-BASS 1	VA SynSeqBs1	17	69	81	52
SYNTH/ VARIOUS	018	VA SYNTH SEQ-BASS 2	VA SynSeqBs2	18	69	81	53
SYNTH/ VARIOUS	019	VA SYNTH SEQ-BASS 3	VA SynSeqBs3	19	69	81	54
SYNTH/ VARIOUS	020	FANTASY	Fantasy	20	69	88	48
SYNTH/ VARIOUS	021	NEW AGE	New Age	21	69	88	49
SYNTH/ VARIOUS	022	WARM PAD	Warm Pad	22	69	89	48
SYNTH/ VARIOUS	023	WARM VOX	Warm Vox	23	69	89	49
SYNTH/ VARIOUS	024	POLYSYNTH PAD	PolysynthPad	24	69	90	48
SYNTH/ VARIOUS	025	SYNTH-PAD	Syn-Pad	25	69	90	49
SYNTH/ VARIOUS	026	BRIGHT SAW PAD	BrightSawPad	26	69	90	50

Group Name	Number	Tone Name	Screen Name	Sending and Receiving		Receiving Only	
				Program Change	Bank Select MSB	Program Change	Bank Select MSB
SYNTH/ VARIOUS	027	ATMOSPHERE PAD	AtmspherePad	27	69	99	48
SYNTH/ VARIOUS	028	VA SYNTH-PAD 1	VA Syn-Pad 1	28	69	90	51
SYNTH/ VARIOUS	029	VA SYNTH-PAD 2	VA Syn-Pad 2	29	69	90	52
SYNTH/ VARIOUS	030	VA SYNTH-PAD 3	VA Syn-Pad 3	30	69	90	53
SYNTH/ VARIOUS	031	GM SQUARE LEAD	GM Squ.Lead	31	69	80	0
SYNTH/ VARIOUS	032	GM SAW LEAD	GM Saw Lead	32	69	81	0
SYNTH/ VARIOUS	033	GM CALLIOPE	GM Calliope	33	69	82	0
SYNTH/ VARIOUS	034	GM CHIFF LEAD	GM ChiffLead	34	69	83	0
SYNTH/ VARIOUS	035	GM CHARANG	GM Charang	35	69	84	0
SYNTH/ VARIOUS	036	GM VOICE LEAD	GM VoiceLead	36	69	85	0
SYNTH/ VARIOUS	037	GM FIFTH LEAD	GM FifthLead	37	69	86	0
SYNTH/ VARIOUS	038	GM BASS+LEAD	GM Bass+Lead	38	69	87	0
SYNTH/ VARIOUS	039	GM FANTASY	GM Fantasy	39	69	88	0
SYNTH/ VARIOUS	040	GM WARM PAD	GM Warm Pad	40	69	89	0
SYNTH/ VARIOUS	041	GM POLYSYNTH	GM PolySynth	41	69	90	0
SYNTH/ VARIOUS	042	GM SPACE CHOIR	GM Space Cho	42	69	91	0
SYNTH/ VARIOUS	043	GM BOWED GLASS	GM Bow Glass	43	69	92	0
SYNTH/ VARIOUS	044	GM METAL PAD	GM Metal Pad	44	69	93	0
SYNTH/ VARIOUS	045	GM HALO PAD	GM Halo Pad	45	69	94	0
SYNTH/ VARIOUS	046	GM SWEEP PAD	GM Sweep Pad	46	69	95	0
SYNTH/ VARIOUS	047	GM RAIN DROP	GM Rain Drop	47	69	96	0
SYNTH/ VARIOUS	048	GM SOUND TRACK	GM SoundTrak	48	69	97	0
SYNTH/ VARIOUS	049	GM CRYSTAL	GM Crystal	49	69	98	0
SYNTH/ VARIOUS	050	GM ATMOSPHERE	GM Atmosphre	50	69	99	0
SYNTH/ VARIOUS	051	GM BRIGHTNESS	GM Brightnes	51	69	100	0
SYNTH/ VARIOUS	052	GM GOBLINS	GM Goblins	52	69	101	0
SYNTH/ VARIOUS	053	GM ECHOES	GM Echoes	53	69	102	0
SYNTH/ VARIOUS	054	GM SF	GM SF	54	69	103	0
SYNTH/ VARIOUS	055	GM SITAR	GM Sitar	55	69	104	0
SYNTH/ VARIOUS	056	GM BANJO	GM Banjo	56	69	105	0
SYNTH/ VARIOUS	057	GM SHAMISEN	GM Shamisen	57	69	106	0
SYNTH/ VARIOUS	058	GM KOTO	GM Koto	58	69	107	0
SYNTH/ VARIOUS	059	GM THUMB PIANO	GM Thumb Pno	59	69	108	0
SYNTH/ VARIOUS	060	GM BAGPIPE	GM Bagpipe	60	69	109	0
SYNTH/ VARIOUS	061	GM FIDDLE	GM Fiddle	61	69	110	0
SYNTH/ VARIOUS	062	GM SHANAI	GM Shanai	62	69	111	0
SYNTH/ VARIOUS	063	GM DULCIMER	GM Dulcimer	63	69	115	0
SYNTH/ VARIOUS	064	GM TINKLE BELL	GM TinkleBel	64	69	112	0
SYNTH/ VARIOUS	065	GM AGOGO	GM Agogo	65	69	113	0
SYNTH/ VARIOUS	066	GM STEEL DRUMS	GM SteelDrum	66	69	114	0
SYNTH/ VARIOUS	067	GM WOOD BLOCK	GM WoodBlock	67	69	115	0
SYNTH/ VARIOUS	068	GM TAIKO	GM Taiko	68	69	116	0
SYNTH/ VARIOUS	069	GM MELODIC TOM	GM Melo.Tom	69	69	117	0
SYNTH/ VARIOUS	070	GM SYNTH-DRUM	GM Syn-Drum	70	69	118	0
SYNTH/ VARIOUS	071	GM REVERSE CYMBAL	GM RevCymbal	71	69	119	0
SYNTH/ VARIOUS	072	GM GT FRET NOISE	GM GtFrNoise	72	69	120	0
SYNTH/ VARIOUS	073	GM BREATH NOISE	GM BrthNoise	73	69	121	0
SYNTH/ VARIOUS	074	GM SEASHORE	GM Seashore	74	69	122	0

Group Name	Number	Tone Name	Screen Name	Sending and Receiving		Receiving Only	
				Program Change	Bank Select MSB	Program Change	Bank Select MSB
SYNTH/ VARIOUS	075	GM BIRD	GM Bird	75	69	123	0
SYNTH/ VARIOUS	076	GM TELEPHONE	GM Telephone	76	69	124	0
SYNTH/ VARIOUS	077	GM HELICOPTER	GM Helicopt	77	69	125	0
SYNTH/ VARIOUS	078	GM APPLAUSE	GM Applause	78	69	126	0
SYNTH/ VARIOUS	079	GM GUNSHOT	GM Gunshot	79	69	127	0
SYNTH/ VARIOUS	080 - 127	User Tones		80 - 127	69		
SYNTH/ VARIOUS	128 - 129	User Tones		0 - 1	70		
DRUMS	000	STANDARD SET 1	StandardSet1	0	125	0	120
DRUMS	001	STANDARD SET 2	StandardSet2	1	125	1	120
DRUMS	002	STANDARD SET 3	StandardSet3	2	125	2	120
DRUMS	003	STANDARD SET 4	StandardSet4	3	125	3	120
DRUMS	004	DANCE SET 1	Dance Set 1	4	125	26	120
DRUMS	005	DANCE SET 2	Dance Set 2	5	125	27	120
DRUMS	006	DANCE SET 3	Dance Set 3	6	125	28	120
DRUMS	007	TRANCE SET	Trance Set	7	125	29	120
DRUMS	008	HIP-HOP SET	Hip-Hop Set	8	125	9	120
DRUMS	009	ROOM SET	Room Set	9	125	8	120
DRUMS	010	POWER SET	Power Set	10	125	16	120
DRUMS	011	ROCK SET	Rock Set	11	125	17	120
DRUMS	012	ELECTRONIC SET	Elec.Set	12	125	24	120
DRUMS	013	SYNTH SET 1	Synth Set 1	13	125	25	120
DRUMS	014	SYNTH SET 2	Synth Set 2	14	125	30	120
DRUMS	015	JAZZ SET	Jazz Set	15	125	32	120
DRUMS	016	BRUSH SET	Brush Set	16	125	40	120
DRUMS	017	ORCHESTRA SET	OrchestraSet	17	125	48	120
DRUMS	018	ETHNIC SET 1	Ethnic Set 1	18	125	49	120
DRUMS	019	ETHNIC SET 2	Ethnic Set 2	19	125	50	120
DRUMS	020 - 039	User Drums		20 - 39	125		
HEX LAYER	000	PX HEX TONE00	PX HexTone00	0	97		
HEX LAYER	001	PX HEX TONE01	PX HexTone01	1	97		
HEX LAYER	002	PX HEX TONE02	PX HexTone02	2	97		
HEX LAYER	003	PX HEX TONE03	PX HexTone03	3	97		
HEX LAYER	004	PX HEX TONE04	PX HexTone04	4	97		
HEX LAYER	005	PX HEX TONE05	PX HexTone05	5	97		
HEX LAYER	006	PX HEX TONE06	PX HexTone06	6	97		
HEX LAYER	007	PX HEX TONE07	PX HexTone07	7	97		
HEX LAYER	008	PX HEX TONE08	PX HexTone08	8	97		
HEX LAYER	009	PX HEX TONE09	PX HexTone09	9	97		
HEX LAYER	010	ICECASTLES	Ice Castles	10	97		
HEX LAYER	011	HOUSETOP	House Top	11	97		
HEX LAYER	012	MAXIMUM	Maximum	12	97		
HEX LAYER	013	MIDNIGHTSUN	Midnight Sun	13	97		
HEX LAYER	014	ORCHESTRA	Orchestra	14	97		
HEX LAYER	015	PX-PAD	PX-Pad	15	97		
HEX LAYER	016	ALORE YE	Alore Ye	16	97		
HEX LAYER	017	TRANSEDSAW	Traned Saw	17	97		
HEX LAYER	018	HEX SYNBRASS	Hex SynBrass	18	97		
HEX LAYER	019	HEX SYNVOICES	HexSynVoices	19	97		
HEX LAYER	020	HEX MFPIANO	Hex Mf Piano	20	97		
HEX LAYER	021	HEX JUNGLEPF	Hex JunglePf	21	97		
HEX LAYER	022	HEX BASIC EP1	Hex BasicEP1	22	97		
HEX LAYER	023	HEX BASIC EP2	Hex BasicEP2	23	97		
HEX LAYER	024	HEX BASIC EP3	Hex BasicEP3	24	97		
HEX LAYER	025	HEX BASIC EP4	Hex BasicEP4	25	97		
HEX LAYER	026	HEX BASIC EP5	Hex BasicEP5	26	97		
HEX LAYER	027	HEX BASIC EP6	Hex BasicEP6	27	97		
HEX LAYER	028	HEX ELEC.CLAV1	Hex EleClav1	28	97		

Group Name	Number	Tone Name	Screen Name	Sending and Receiving		Receiving Only	
				Program Change	Bank Select MSB	Program Change	Bank Select MSB
HEX LAYER	029	HEX ELEC.CLAV2	Hex EleClav2	29	97		
HEX LAYER	030	HEX ENSEMBLE1	HexEnsemble1	30	97		
HEX LAYER	031	HEX ENSEMBLE2	HexEnsemble2	31	97		
HEX LAYER	032	HEX PIPE ORGAN	HexPipeorgan	32	97		
HEX LAYER	033	HEX SAX LAYER	Hex SaxLayer	33	97		
HEX LAYER	034	HEX WOOD LAYER	HexWoodLayer	34	97		
HEX LAYER	035	HEX REED LAYER	HexReedLayer	35	97		
HEX LAYER	036	HEX TOP OCTAVE	HexTopOctave	36	97		
HEX LAYER	037	HEX PICK LAYER	HexPickLayer	37	97		
HEX LAYER	038	HEX SPLIT1	Hex Split1	38	97		
HEX LAYER	039	HEX SPLIT2	Hex Split2	39	97		
HEX LAYER	040	HEX SYN-LEAD1	Hex SynLead1	40	97		
HEX LAYER	041	HEX SYN-LEAD2	Hex SynLead2	41	97		
HEX LAYER	042	HEX SYN-LEAD3	Hex SynLead3	42	97		
HEX LAYER	043	HEX SYN-LEAD4	Hex SynLead4	43	97		
HEX LAYER	044	HEX SYN-LEAD5	Hex SynLead5	44	97		
HEX LAYER	045	HEX SYN-BASIC1	HexSynBasic1	45	97		
HEX LAYER	046	HEX SYN-BASIC2	HexSynBasic2	46	97		
HEX LAYER	047	HEX SYN-BASIC3	HexSynBasic3	47	97		
HEX LAYER	048	HEX SYN-BASIC4	HexSynBasic4	48	97		
HEX LAYER	049	HEX SYN-BASIC5	HexSynBasic5	49	97		
HEX LAYER	050 - 127	User HexLayer Tones		50 - 127	97		
HEX LAYER	128 - 199	User HexLayer Tones		0 - 71	98		

 **NOTE**

- See the “Drum Assignment List” (page E-46) for the percussion instrument assigned to each keyboard key when a drum set (“DRUMS”) is selected.

# Drum Assignment List

- " ← " indicates a key is assigned the same tones as it is for STANDARD SET 1.

Key	Note No.	STANDARD SET 1	STANDARD SET 2	STANDARD SET 3	STANDARD SET 4	DANCE SET 1	DANCE SET 2	DANCE SET 3
C-1	0	Tabla Ge	←	←	←	Dance Kick 1	←	←
	1	Tabla Ka	←	←	←	Dance Kick 2	←	←
D-1	2	Tabla Te	←	←	←	Dance Kick 3	←	←
	3	Tabla Na	←	←	←	Dance Kick 4	←	←
E-1	4	Tabla Tun	←	←	←	Dance Kick 5	←	←
F-1	5	Dholak Ge	←	←	←	Dance Snare 1	←	←
	6	Dholak Ke	←	←	←	Dance Snare 2	←	←
G-1	7	Dholak Ta 1	←	←	←	Dance Snare 3	←	←
	8	Dholak Ta 2	←	←	←	Dance Snare 4	←	←
A-1	9	Dholak Na	←	←	←	Dance Snare 5	←	←
	10	Dholak Ta 3	←	←	←	Dance Snare 6	←	←
B-1	11	Dholak Ping	←	←	←	Dance Snare 7	←	←
C0	12	Mridangam Tha	←	←	←	Dance Snare 8	←	←
	13	Mridangam Dhom	←	←	←	Dance Snare 9	←	←
D0	14	Mridangam Dhi	←	←	←	Dance Tambourine	←	←
	15	Mridangam Dhin	←	←	←	Hip-Hop Snare 4	←	←
E0	16	Mridangam Num	←	←	←	Hip-Hop Snare 3	←	←
	17					Techno Snare		
F0	18					Hip-Hop Rim Shot		
	19					Hip-Hop Snare 3 Rev.		
A0	20					Synth2 Kick 1 Rev.		
	21					Reverse Cymbal Gate		
B0	22					Hip-Hop Snare 4 Gate		
	23					Hip-Hop Snare 3 Gate		
C1	24					Techno Snare Gate		
	25					Hip-Hop Side Stick Gate		
E1	26					Hand Clap 2 Gate		
	27	High Q	←	←	←		←	←
E1	28	Slap	←	←	←		←	←
	29	Scratch Push	←	←	←	Hip-Hop Scratch 1	←	←
F1	30	Scratch Pull	←	←	←	Hip-Hop Scratch 2	←	←
G1	31	Sticks	←	←	←		←	←
	32	Square Click	←	←	←		←	←
A1	33	Metronome Click	←	←	←		←	←
	34	Metronome Bell	←	←	←		←	←
B1	35	Standard1 Kick 2	Standard2 Kick 2	Standard3 Kick 2	Standard4 Kick 2	Synth2 Kick 2	Hip-Hop Kick 3	Dance Kick 2
	36	Standard1 Kick 1	Standard2 Kick 1	Standard3 Kick 1	Standard4 Kick 1	Synth2 Kick 1	Dance Kick 5	Dance Kick 4
C2	37	Side Stick	Standard2 Side Stick	Standard3 Side Stick	Standard4 Side Stick		Hand Clap 3	Hip-Hop Side Stick Gate
D2	38	Standard1 Snare 1	Standard2 Snare 1	Standard3 Snare 1	Standard4 Snare 1	Synth2 Snare 1	Dance Snare 7	Dance Snare 2
E2	39	Hand Clap	←	Standard3 Hand Clap	←	←	Hand Clap 2	Synth1 Hand Clap
	40	Standard1 Snare 2	Standard2 Snare 2	Standard3 Snare 2	Standard4 Snare 2	Synth2 Snare 2	Techno Snare	Dance Snare 1 Gate
F2	41	Low Tom 2	←	Standard3 Low Tom 2	←	Synth2 Low Tom 2	Synth2 Low Tom 2	Standard3 Low Tom 2
	42	Closed Hi-Hat	Standard2 Closed Hi-Hat	Standard3 Closed Hi-Hat	←	Synth2 Closed Hi-Hat 1	Trance Closed Hi-Hat	Standard3 Closed Hi-Hat
G2	43	Pedal Hi-Hat	←	Standard3 Low Tom 1	←	Synth2 Low Tom 1	Synth2 Low Tom 1	Standard3 Low Tom 1
A2	44	Pedal Hi-Hat	Standard2 Pedal Hi-Hat	Standard3 Pedal Hi-Hat	←	Synth2 Closed Hi-Hat 2	Trance Open Hi-Hat 1	Standard3 Pedal Hi-Hat
	45	Mid Tom 2	←	Standard3 Mid Tom 2	←	Synth2 Mid Tom 2	Synth2 Mid Tom 2	Standard3 Mid Tom 2
B2	46	Open Hi-Hat	Standard2 Open Hi-Hat	Standard3 Open Hi-Hat	←	Synth2 Open Hi-Hat	Trance Open Hi-Hat 2	Standard3 Open Hi-Hat
	47	Mid Tom 1	←	Standard3 Mid Tom 1	←	Synth2 Mid Tom 1	Synth2 Mid Tom 1	Standard3 Mid Tom 1
C3	48	High Tom 2	←	Standard3 High Tom 2	←	Synth2 Hi Tom 2	Synth2 High Tom 2	Standard3 High Tom 2
D3	49	Crash Cymbal 1	←	←	←	←	←	←
	50	High Tom 1	←	Standard3 High Tom 1	←	Synth2 Hi Tom 1	Synth2 High Tom 1	Standard3 High Tom 1
E3	51	Ride Cymbal 1	←	←	←	←	←	←
	52	Chinese Cymbal	←	←	←	←	←	←
F3	53	Ride Bell	←	←	←	←	←	←
	54	Tambourine	←	←	←	←	←	←
G3	55	Splash Cymbal	←	←	←	←	←	←
	56	Cowbell	←	←	←	←	←	←
A3	57	Crash Cymbal 2	←	←	←	Synth2 Cymbal 2	←	←
	58	Vibraslap	←	←	←	←	←	←
B3	59	Ride Cymbal 2	←	←	←	Synth1 Kick 2	←	←
	60	High Bongo	←	←	←	Synth1 Kick 1	←	←
C4	61	Low Bongo	←	←	←	Synth1 Rim Shot	←	←
D4	62	Mute High Conga	←	←	←	Synth1 Snare 1	←	←
E4	63	Open High Conga	←	←	←	Synth1 Hand Clap	←	←
	64	Open Low Conga	←	←	←	Synth1 Snare 2	←	←
F4	65	High Timbale	←	←	←	Synth1 Low Tom 2	←	←
	66	Low Timbale	←	←	←	Synth1 Chh	←	←
G4	67	High Agogo	←	←	←	Synth1 Low Tom 1	←	←
	68	Low Agogo	←	←	←	Synth1 Phh	←	←
A4	69	Cabasa	←	←	←	Synth1 Mid Tom 2	←	←
	70	Maracas	←	←	←	Synth1 Ohh	←	←
B4	71	Short High Whistle	←	←	←	Synth1 Mid Tom 1	←	←
	72	Long Low Whistle	←	←	←	Synth1 Hi Tom 2	←	←
C5	73	Short Guiro	←	←	←	Synth1 Cymbal	←	←
D5	74	Long Guiro	←	←	←	Synth1 Hi Tom 1	←	←
E5	75	Claves	←	←	←	Synth1 Ride	←	←
	76	High Wood Block	←	←	←	Chinese Cymbal	←	←
F5	77	Low Wood Block	←	←	←	Ride Bell	←	←
	78	Mute Cuica	←	←	←	Synth 1 Tambourine	←	←
G5	79	Open Cuica	←	←	←	Splash Cymbal	←	←
	80	Mute Triangle	←	←	←	Synth 1 Cowbell	←	←
A5	81	Open Triangle	←	←	←	Crash Cymbal 2	←	←
	82	Shaker	←	←	←	Vibraslap	←	←
B5	83	Jingle Bell	←	←	←	Synth1 Kick 3	←	←
	84	Bell Tree	←	←	←	Hip-Hop Kick 3	←	←
C6	85	Castanets	←	←	←	Standard2 Kick 1	←	←
	86	Mute Surdo	←	←	←	Standard2 Snare 1	←	←
D6	87	Open Surdo	←	←	←	Hand Clap 3	←	←
E6	88	Applause 1	←	←	←	Standard2 Snare 2	←	←
	89	Applause 2	←	←	←	Elec Low Tom 2	←	←
F6	90					Hip-Hop Closed Hi-Hat		
	91					Elec Low Tom 1		
G6	92					Hip-Hop Pedal Hi-Hat		
A6	93					Elec Mid Tom 2		
	94					Hip-Hop Open Hi-Hat		
B6	95					Elec Mid Tom 1		
	96					Elec Hi Tom 2		
C7	97					Techno Cymbal		
D7	98					Elec Hi Tom 1		
E7	99					Techno Ride		
	100							
F7	101					Low Tom 2		
	102					Closed Hi-Hat		
G7	103					Low Tom 1		
	104					Pedal Hi-Hat		
A7	105					Mid Tom 2		
	106					Open Hi-Hat		
B7	107					Mid Tom 1		
	108					High Tom 2		
C8	109	Tablah 1	←	←	←	Crash Cymbal 1	←	←
D8	110	Tablah 2	←	←	←	High Tom 1	←	←
	111	Tablah 3	←	←	←	Ride Cymbal 1	←	←
E8	112	Daf 1	←	←	←		←	←
	113	Daf 2	←	←	←		←	←
F8	114	Riq 1	←	←	←	Tambourine 2	←	←
	115	Riq 2	←	←	←	Tambourine 3	←	←
G8	116	Riq 3	←	←	←	Cabasa 2	←	←
	117	Davul 1	←	←	←	Maracas 2	←	←
A8	118	Davul 2	←	←	←	Claves 2	←	←
	119	Zill 1	←	←	←	Mute Triangle 2	←	←
B8	120	Zill 2	←	←	←	Open Triangle 2	←	←
	121	Ban Gu	←	←	←	Shaker 2	←	←
C9	122	Hu Yin Luo	←	←	←	Hand Clap	←	←
D9	123	Xiao Luo	←	←	←	Hand Clap 2	←	←
	124	Xiao Bo	←	←	←		←	←
E9	125	Low Tang Gu	←	←	←		←	←
	126	Mid Tang Gu	←	←	←		←	←
F9	127	High Tang Gu	←	←	←		←	←
G9	127	High Tang Gu	←	←	←		←	←



Key	Note No.	TRANCE SET	HIP-HOP SET	ROOM SET	POWER SET	ROCK SET	ELECTRONIC SET	SYNTH SET 1
C-1	0							
C-1	1							
D-1	2							
E-1	3							
E-1	4							
F-1	5							
F-1	6							
G-1	7							
A-1	8							
A-1	9							
B-1	10							
B-1	11							
C0	12							
C0	13							
D0	14							
D0	15							
E0	16							
F0	17							
F0	18							
G0	19							
A0	20							
A0	21							
B0	22							
B0	23							
C1	24							
C1	25							
D1	26							
E1	27							
E1	28							
F1	29							
F1	30							
G1	31							
G1	32							
A1	33							
A1	34							
B1	35	Trance Kick 2	Hip-Hop Kick 2	Room Kick 2	Power Kick 2	Rock Kick 2	Elec. Kick 2	Synth1 Kick 2
B1	36	Trance Kick 1	Hip-Hop Kick 1	Room Kick 1	Power Kick 1	Rock Kick 1	Elec. Kick 1	Synth1 Kick 1
C2	37	Trance Side Stick	Hip-Hop Side Stick			Rock Side Stick		Synth1 Rim Shot
D2	38	Trance Snare 1	Hip-Hop Snare 1	Room Snare 1	Power Snare 1	Rock Snare 1	Elec. Snare 1	Synth1 Snare 1
E2	39	Trance Hand Clap	Hip-Hop Hand Clap					Synth1 Hand Clap
E2	40	Trance Snare 2	Hip-Hop Snare 2	Room Snare 2	Power Snare 2	Rock Snare 2	Elec. Snare 2	Synth1 Snare 2
F2	41	Trance Closed Hi-Hat	Hip-Hop Closed Hi-Hat	Room Low Tom 2	Room Low Tom 2	Rock Closed Hi-Hat	Elec. Low Tom 2	Synth1 Low Tom 2
G2	42	Trance Open Hi-Hat 1	Hip-Hop Open Hi-Hat 1	Room Low Tom 1	Room Low Tom 1	Rock Open Hi-Hat 1	Elec. Low Tom 1	Synth1 Closed Hi-Hat 1
A2	43	Trance Open Hi-Hat 2	Hip-Hop Open Hi-Hat 2	Room Low Tom 1	Room Low Tom 1	Rock Open Hi-Hat 2	Elec. Low Tom 1	Synth1 Closed Hi-Hat 2
B2	44	Trance Open Hi-Hat 1	Hip-Hop Pedal Hi-Hat	Room Mid Tom 2	Room Mid Tom 2	Rock Pedal Hi-Hat	Elec. Mid Tom 2	Synth1 Mid Tom 2
B2	45	Trance Open Hi-Hat 2	Hip-Hop Open Hi-Hat	Room Mid Tom 2	Room Mid Tom 2	Rock Open Hi-Hat	Elec. Mid Tom 2	Synth1 Open Hi-Hat
C3	46			Room Mid Tom 1	Room Mid Tom 1		Elec. Mid Tom 1	Synth1 Mid Tom 1
C3	47			Room High Tom 2	Room High Tom 2		Elec. High Tom 2	Synth1 High Tom 2
D3	48			Room High Tom 1	Room High Tom 1	Rock Crash Cymbal	Elec. High Tom 1	Synth1 Crash Cymbal
E3	49					Rock Ride Cymbal	Reverse Cymbal	Synth1 Ride Cymbal
F3	50							
F3	51	Trance Tambourine				Rock Splash Cymbal		Synth1 Tambourine
G3	52							
A3	53							Synth1 Cowbell
A3	54							
B3	55							
B3	56							
C4	57							Synth1 High Bongo
C4	58							Synth1 Low Bongo
D4	59							Synth1 Mute Hi Conga
E4	60							Synth1 Open Hi Conga
F4	61							Synth1 Open Low Conga
F4	62							
G4	63							
A4	64							
A4	65							
B4	66							Synth1 Maracas
B4	67							
C5	68							
C5	69							
D5	70							
E5	71							Synth1 Claves
F5	72							
F5	73							
G5	74							
A5	75							
A5	76							
B5	77							
B5	78							
C6	79							
C6	80							
D6	81							
E6	82							
E6	83							
F6	84							
F6	85							
G6	86							
A6	87							
A6	88							
B6	89							
B6	90							
C7	91							
C7	92							
D7	93							
E7	94							
E7	95							
F7	96							
F7	97							
G7	98							
A7	99							
A7	100							
B7	101							
B7	102							
C8	103							
C8	104							
D8	105							
E8	106							
E8	107							
F8	108							
F8	109							
G8	110							
G8	111							
A8	112							
A8	113							
B8	114							
B8	115							
C9	116							
C9	117							
D9	118							
E9	119							
E9	120							
F9	121							
F9	122							
G9	123							
G9	124							
G9	125							
G9	126							
G9	127							

Key	Note No.	SYNTH SET 2	JAZZ SET	BRUSH SET	ORCHESTRA SET	ETHNIC SET 1	ETHNIC SET 2
C-1	0						
C-1	1						
D-1	2						
E-1	3						
F-1	4						
G-1	5						
A-1	6						
B-1	7						
C0	8						
D0	9						
E0	10						
F0	11						
G0	12						
A0	13						
B0	14						
C1	15						
D1	16						
E1	17						
F1	18						
G1	19						
A1	20						
B1	21						
C2	22						
D2	23						
E2	24						
F2	25						
G2	26						
A2	27						
B2	28						
C3	29						
D3	30						
E3	31						
F3	32						
G3	33						
A3	34						
B3	35						
C4	36						
D4	37						
E4	38						
F4	39						
G4	40						
A4	41						
B4	42						
C5	43						
D5	44						
E5	45						
F5	46						
G5	47						
A5	48						
B5	49						
C6	50						
D6	51						
E6	52						
F6	53						
G6	54						
A6	55						
B6	56						
C7	57						
D7	58						
E7	59						
F7	60						
G7	61						
A7	62						
B7	63						
C8	64						
D8	65						
E8	66						
F8	67						
G8	68						
A8	69						
B8	70						
C9	71						
D9	72						
E9	73						
F9	74						
G9	75						
	76						
	77						
	78						
	79						
	80						
	81						
	82						
	83						
	84						
	85						
	86						
	87						
	88						
	89						
	90						
	91						
	92						
	93						
	94						
	95						
	96						
	97						
	98						
	99						
	100						
	101						
	102						
	103						
	104						
	105						
	106						
	107						
	108						
	109						
	110						
	111						
	112						
	113						
	114						
	115						
	116						
	117						
	118						
	119						
	120						
	121						
	122						
	123						
	124						
	125						
	126						
	127						

## Arpeggio Type List

Number	Type Name	Number	Type Name	Number	Type Name	Number	Type Name
000	Screw Up	026	Soul Bass 2	052	Poly 1	078	Random 3Oct
001	Screw Down	027	Shuffle Bass	053	Poly 2	079	Random 4Oct
002	Panning Up	028	Funk Bass	054	Poly 3	080	Repeat 1
003	Filtering	029	Bossa Bass	055	Poly 4	081	Repeat 2
004	Skip Up	030	8 Beat Bass	056	Poly 5	082	Add 5th Up
005	Skip Down	031	R&B Bass	057	Poly 6	083	Add 5th Down
006	Up Up Down	032	Bass Line 1	058	Poly 7	084	Add 5th U/D
007	Down Down Up	033	Bass Line 2	059	Poly 8	085	5th Up 1
008	Step Arp 1	034	Scale 1	060	Up	086	5th Up 2
009	Step Arp 2	035	Scale 2	061	Up 2Oct	087	Octave Up 1
010	Seq Lines	036	Scale 3	062	Up 3Oct	088	Octave Up 2
011	Synth Seq 1	037	Scale 4	063	Up 4Oct	089	Octave Down
012	Synth Seq 2	038	Blues Scale	064	Down	090	Poly Up
013	Seq Line 1	039	Penta Scale	065	Down 2Oct	091	Poly Down
014	Seq Line 2	040	Funky EP	066	Down 3Oct	092	Poly Line
015	Seq Line 3	041	Ragtime	067	Down 4Oct	093	4th Up
016	Seq Line 4	042	Riff	068	Up Down A	094	4th Down
017	Seq Line 5	043	Ska	069	UpDownA 2Oct	095	New Age
018	Seq Line 6	044	8 Beat	070	UpDownA 3Oct	096	Gtr Strk 1
019	Seq Line 7	045	12/8	071	UpDownA 4Oct	097	Gtr Strk 2
020	Prelude	046	Shuffle	072	Up Down B	098	Latin Pf 1
021	Arp 2 Oct	047	Waltz	073	UpDownB 2Oct	099	Latin Pf 2
022	9th Arp 1	048	Shuffle Pop	074	UpDownB 3Oct		
023	9th Arp 2	049	Hard Rock	075	UpDownB 4Oct		
024	9th Arp 3	050	Echo	076	Random		
025	Soul Bass 1	051	Trill	077	Random 2Oct		

## Wave List

Number	Wave Name	Number	Wave Name	Number	Wave Name	Number	Wave Name
0	GrPiano1-L	46	EP Attack3	92	PercOrgan3 2	138	ViolnSect2
1	GrPiano1-R	47	EP Attack4	93	Drawbar Org1	139	OrchestrPad1
2	GrPiano2-L	48	EP Attack5	94	Drawbar Org2	140	OrchestrPad2
3	GrPiano2-R	49	EP Attack6	95	Drawbar Org3	141	Choir1
4	GrPiano3-L	50	EP Attack7	96	Elec.Organ 1	142	Choir2
5	GrPiano3-R	51	EP Attack8	97	Elec.Organ 2	143	Synth-Voice1
6	GrPiano4-L	52	EP Attack9	98	Elec.Organ 3	144	Synth-Voice2
7	GrPiano4-R	53	EP Attack10	99	70's Organ	145	VoiceEnsemb1
8	PianoAttack1	54	EP Attack11	100	OverdriveOrg	146	VoiceEnsemb2
9	PianoAttack2	55	EP Attack12	101	Tremolo Org	147	SynVoice Pad
10	PianoAttack3	56	Clavi 1 1	102	Click Organ	148	BrassSect1
11	AiR E. Piano1	57	Clavi 1 2	103	Organ Click	149	BrassSect2
12	AiR E. Piano2	58	Clavi 2 1	104	8'Organ1	150	Syn-Brass 11
13	AiR E. Piano3	59	Clavi 2 2	105	8'Organ2	151	Syn-Brass 12
14	AiR E. Piano4	60	Clavi Off	106	Seq.Organ1	152	Syn-Brass 21
15	AiR 60's EP1	61	ClaviAttack1	107	Seq.Organ2	153	Syn-Brass 22
16	AiR 60's EP2	62	ClaviAttack2	108	ChurchOrgan1	154	80sSynBrass1
17	AiR 60's EP3	63	Harpsichord	109	ChurchOrgan2	155	80sSynBrass2
18	AiR 60's EP4	64	Harpsi Off	110	Chapel Organ	156	Brass Ens.1
19	ElecPiano 1	65	CouplHarpsi	111	GM Organ 1	157	Brass Ens.2
20	ElecPiano 1 2	66	Vibraphone	112	GM Organ 21	158	BreathyASax1
21	ElecPiano 2 1	67	GM E. Piano11	113	GM Organ 22	159	BreathyASax2
22	ElecPiano 2 2	68	GM E. Piano12	114	GM Organ 31	160	BreathyASax3
23	ElecPiano 2 3	69	GM E. Piano2	115	GM Organ 32	161	BreathyTSax1
24	60'sE. Piano1	70	GM Harpsi.	116	GMPipeOrgan1	162	BreathyTSax2
25	60'sE. Piano2	71	GM Clavi	117	GMPipeOrgan2	163	BreathyTSax3
26	E. Grand 80	72	GM Celesta	118	GM ReedOrgan	164	GM Violin
27	DynoE. Piano1	73	GM Glocken.	119	GM Accordion1	165	GM Viola
28	DynoE. Piano2	74	GM MusicBox1	120	GM Accordion2	166	GM Cello
29	FM E. Piano	75	GM MusicBox2	121	GM Harmonica	167	GM Contrabas
30	MelowEPiano1	76	GM Vibraphon	122	GMBandoneon1	168	GM Trem.Str.
31	MelowEPiano2	77	GM Marimba	123	GMBandoneon2	169	GM Pizzicato
32	Digital EP1A	78	GM Xylophone	124	StreoString1	170	GM Harp
33	Digital EP1B	79	GM TublarBel	125	StreoString2	171	GM Timpani
34	Digital EP1C	80	Rock Organ 1	126	String Ens.	172	GM Strings 1
35	Digital EP2A	81	RockOrgan2 1	127	Slow Strings	173	GM Strings 2
36	Digital EP2B	82	RockOrgan2 2	128	BritStrings1	174	GM Syn-Str.1
37	Digital EP2C	83	Rock Organ 3	129	BritStrings2	175	GM Syn-Str.2
38	Digital EP3A	84	JazzOrgan1 1	130	Warm Strings	176	GM ChoirAahs
39	Digital EP3B	85	JazzOrgan1 2	131	SynStrings11	177	GM Voice Doo
40	Digital EP3C	86	JazzOrgan2 1	132	SynStrings12	178	GM Syn-Voice
41	Digital EP4	87	JazzOrgan2 2	133	Syn-Strings2	179	GM Orch.Hit1
42	Analog EP1	88	Perc.Organ 1	134	Syn-Strings3	180	GM Orch.Hit2
43	Analog EP2	89	PercOrgan2 1	135	70's Syn-Str	181	GM Trumpet1
44	EP Attack1	90	PercOrgan2 2	136	80's Syn-Str	182	GM Trumpet2
45	EP Attack2	91	PercOrgan3 1	137	ViolnSect1	183	GM Trombone

Number	Wave Name	Number	Wave Name	Number	Wave Name
184	GM Tuba	269	GM PickBass1	354	GM Fantasy1
185	GMMtTrumpet1	270	GM PickBass2	355	GM Fantasy2
186	GMMtTrumpet2	271	GMFretlesBs1	356	GM Warm Pad
187	GM Fr.Horn1	272	GMFretlesBs2	357	GMPolySynth1
188	GM Fr.Horn2	273	GM SlapBass1	358	GMPolySynth2
189	GM Brass1	274	GMslapBass21	359	GM SpaceCho1
190	GM Brass2	275	GMslapBass22	360	GM SpaceCho2
191	GMSynBrass11	276	GM SynBass11	361	GM BowGlass1
192	GMSynBrass12	277	GM SynBass12	362	GM BowGlass2
193	GMSynBrass21	278	GM Syn-Bass2	363	GM MetalPad1
194	GMSynBrass22	279	Saw Lead 11	364	GM MetalPad2
195	GM Sop.Sax	280	Saw Lead 12	365	GM Halo Pad1
196	GM Alto Sax	281	Saw Lead 21	366	GM Halo Pad2
197	GM Tenor Sax	282	Saw Lead 22	367	GM Sweep Pad
198	GM Bar.Sax	283	Saw Lead 3	368	GM RainDrop1
199	GM Oboe	284	MelwSawLead1	369	GM RainDrop2
200	GM Eng.Horn	285	MelwSawLead2	370	GMSoundTrak1
201	GM Bassoon	286	SquareLead11	371	GMSoundTrak2
202	GM Clarinet	287	SquareLead12	372	GM Crystal1
203	GM Piccolo	288	Square Lead2	373	GM Crystal2
204	GM Flute	289	PulseLead11	374	GMAtmosphre1
205	GM Recorder	290	PulseLead12	375	GMAtmosphre2
206	GM Pan Flute	291	PulseLead21	376	GMBrightnes1
207	GM BotleBlow	292	PulseLead22	377	GMBrightnes2
208	GMShakuhach1	293	Sine Lead	378	GM Goblins1
209	GMShakuhach2	294	Sqr PulseLd1	379	GM Goblins2
210	GM Whistle	295	Sqr PulseLd2	380	GM Echoes
211	GM Ocarina	296	VA Synth 1	381	GM SF1
212	AcousBass 11	297	VA Synth 2	382	GM SF2
213	AcousBass 12	298	VA Synth 3	383	GM Sitar
214	AcousBass 13	299	VA Synth 4	384	GM Banjo
215	AcousBass 21	300	VA Synth 5	385	GM Shamisen
216	AcousBass 22	301	VA Synth 6	386	GM Koto
217	AcousBass 23	302	VA Synth 7	387	GM Thumb Pno
218	Ride Bass	303	VA Synth 8	388	GM Bagpipe1
219	FingerBass 2	304	VA Synth 9	389	GM Bagpipe2
220	FingerBass 3	305	VA Synth 10	390	GM Fiddle
221	Picked Bass	306	VA Synth 11	391	GM Shanai
222	Synth-Bass11	307	VA Synth 12	392	GM Dulcimer
223	Synth-Bass12	308	VA Synth 13	393	GM TinkleBel
224	Synth-Bass13	309	SequenceSaw1	394	GM Agogo
225	Synth-Bass14	310	SequenceSaw2	395	GMSteelDrum1
226	Synth-Bass21	311	SawArpeggio1	396	GMSteelDrum2
227	Synth-Bass22	312	SawArpeggio2	397	GM WoodBlock
228	Synth-Bass23	313	VA SynSeqBs1	398	GM Taiko
229	Synth-Bass24	314	VA SynSeqBs2	399	GM Melo.Tom
230	Synth-Bass31	315	VA SynSeqBs3	400	GM Syn-Drum
231	Synth-Bass32	316	Fantasy1	401	GM RevCymbal
232	Synth-Bass 4	317	Fantasy2	402	GM GtFrNoise
233	Synth-Bass 5	318	New Age1	403	GM BrthNoise
234	Synth-Bass 6	319	New Age2	404	GM Seashore1
235	Trance Bass1	320	Warm Pad	405	GM Seashore2
236	Add FingBs1	321	Warm Vox1	406	GM Bird1
237	Add FingBs2	322	Warm Vox2	407	GM Bird2
238	Add FingBs3	323	Syn-Bell Atk	408	GM Telephone
239	Add PickBs1	324	SynVoice Atk	409	GM Helicopt
240	Add PickBs2	325	Syn-Pad1	410	GM Applause1
241	Add SynBs1	326	Syn-Pad2	411	GM Applause2
242	Add SynBs2	327	BrightSawPd1	412	GM Gunshot
243	Add SynBs3	328	BrightSawPd2	413	Sin Wave
244	SteelGuitr11	329	AtmspherePd1	414	SawtoothWave
245	SteelGuitr12	330	AtmspherePd2	415	Square Wave
246	Clean Guitar	331	VA Syn-Pad 1	416	Pulse Wave
247	Crunch E.Gt	332	VA Syn-Pad 2	417	White Noise
248	OverdriveGt1	333	VA Syn-Pad 3	418	Pink Noise
249	OverdriveGt2	334	GM Squ.Lead1		
250	Mute Ovd Gt	335	GM Squ.Lead2		
251	GM Nylon Gt1	336	GM Saw Lead1		
252	GM Nylon Gt2	337	GM Saw Lead2		
253	GM Steel Gt1	338	GM Calliope1		
254	GM Steel Gt2	339	GM Calliope2		
255	GM Jazz Gt	340	GMChiffLead1		
256	GM Clean Gt1	341	GMChiffLead2		
257	GM Clean Gt2	342	GM Charang1		
258	GM Mute Gt1	343	GM Charang2		
259	GM Mute Gt2	344	GMVoiceLead1		
260	GMOverdrive1	345	GMVoiceLead2		
261	GMOverdrive2	346	GMFifthLead1		
262	GM Dist.Gt	347	GMFifthLead2		
263	GM Gt Harm.	348	GMFifthLead3		
264	GMAcousBass1	349	GMFifthLead4		
265	GMAcousBass2	350	GMBass+Lead1		
266	GMAcousBass3	351	GMBass+Lead2		
267	GM FingerBs1	352	GMBass+Lead3		
268	GM FingerBs2	353	GMBass+Lead4		

## Instrument List

Number	Wave Name	Number	Wave Name	Number	Wave Name	Number	Wave Name
0	Blank Inst	81	Side Stick	162	ReverseCymb	243	Timpani F#
1	Std1 Kick1	82	Std3SidStick	163	Syn1CrashCym	244	Timpani G
2	Std1 Kick2	83	HpHpSidStick	164	TechnoCymbal	245	Timpani G#
3	Std2 Kick1	84	RockSidStick	165	BrshCrshCym1	246	Timpani A
4	Std2 Kick2	85	Syn1 RimShot	166	BrshCrshCym2	247	Timpani A#
5	Std3 Kick 1	86	TrcSideStick	167	BrshSplshCym	248	Timpani B
6	Std3 Kick 2	87	HpHp RimShot	168	RideCymbal 1	249	Timpani c+
7	Std4 Kick 1	88	BrshSidStick	169	RideCymbal 2	250	Timpani c#+
8	Std4 Kick 2	89	Hand Clap	170	Ride Bell	251	Timpani d+
9	HipHop Kick1	90	Std3HandClap	171	RockRideCymb	252	Timpani d#+
10	HipHop Kick2	91	HipHpHndClap	172	Syn1 RideCym	253	Timpani e+
11	HipHopKick3	92	Syn1HandClap	173	Techno Ride	254	Timpani f+
12	Room Kick 1	93	Trc HandClap	174	BrshRideCym1	255	Tabla Ge
13	Room Kick 2	94	Hand Clap 2	175	BrshRideCym2	256	Tabla Ka
14	Power Kick 1	95	Hand Clap 3	176	BrshRideBell	257	Tabla Te
15	Power Kick 2	96	High Tom 1	177	Concert Cym1	258	Tabla Na
16	Power Snare1	97	High Tom 2	178	Concert Cym2	259	Tabla Tun
17	Power Snare2	98	Mid Tom 1	179	High Q	260	Dholak Ge
18	Rock Kick 1	99	Mid Tom 2	180	Slap	261	Dholak Ke
19	Rock Kick 2	100	Low Tom 1	181	Square Click	262	Dholak Ta 1
20	Elec.Kick 1	101	Low Tom 2	182	Sticks	263	Dholak Ta 2
21	Elec.Kick 2	102	Std3HighTom1	183	Metron.Click	264	Dholak Na
22	Syn1 Kick 1	103	Std3HighTom2	184	Metron.Bell	265	Dholak Ta 3
23	Syn1 Kick 2	104	Std3MidTom1	185	Scratch Push	266	Dholak Ring
24	Synth1Kick3	105	Std3MidTom2	186	Scratch Pull	267	MridangamTha
25	Syn2 Kick 1	106	Std3LowTom1	187	HpHpScratch1	268	MridangmDhom
26	Syn2 Kick 2	107	Std3LowTom2	188	HpHpScratch2	269	MridangmDhi
27	Syn2Kick1Rev	108	RoomHighTom1	189	Tambourin1	270	MridangmDhin
28	Trance Kick1	109	RoomHighTom2	190	Tambourin2	271	MridangmNum
29	Trance Kick2	110	RoomMidTom1	191	Tambourin3	272	Ban Gu
30	Dance Kick 1	111	RoomMidTom2	192	Syn1 Tambrin	273	Hu Yin Luo
31	Dance Kick 2	112	RoomLowTom1	193	TrcTambourin	274	Xiao Luo
32	Dance Kick 3	113	RoomLowTom2	194	DancTamborin	275	Xiao Bo
33	Dance Kick 4	114	ElecHighTom1	195	BrTambourn	276	Low Tang Gu
34	Dance Kick 5	115	ElecHighTom2	196	Cowbell	277	Mid Tang Gu
35	Jazz Kick 1	116	Elec.MidTom1	197	Syn1 Cowbell	278	High Tang Gu
36	Jazz Kick 2	117	Elec.MidTom2	198	Vibraslap	279	Tablah 1
37	Brush Kick 1	118	Elec.LowTom1	199	High Bongo	280	Tablah 2
38	Concert BD	119	Elec.LowTom2	200	Low Bongo	281	Tablah 3
39	Std1 Snar1	120	Syn1 HiTom1	201	Syn1 HiBongo	282	Daf 1
40	Std1 Snar2	121	Syn1 HiTom2	202	Syn1LowBongo	283	Daf 2
41	Std2Snare1	122	Syn1 MidTom1	203	Mute HiConga	284	Riq 1
42	Std2Snare2	123	Syn1 MidTom2	204	Open HiConga	285	Riq 2
43	Std3 Snare 1	124	Syn1 LowTom1	205	OpenLowConga	286	Riq 3
44	Std3 Snare 2	125	Syn1 LowTom2	206	Syn1MHiCong	287	Davul 1
45	Std4 Snare 1	126	Syn2 HiTom1	207	Syn1OpHiCong	288	Davul 2
46	Std4 Snare 2	127	Syn2 HiTom2	208	Syn1OpLoCong	289	Zill 1
47	Room Snare 1	128	Syn2 MidTom1	209	High Timbale	290	Zill 2
48	Room Snare 2	129	Syn2 MidTom2	210	Low Timbale		
49	HipHopSnare1	130	Syn2 LowTom1	211	High Agogo		
50	HipHopSnare2	131	Syn2 LowTom2	212	Low Agogo		
51	HipHopSnare3	132	CloseHiHat	213	Cabasa		
52	HpHpSnar3Rev	133	PedalHiHat	214	Cabasa 2		
53	HipHopSnare4	134	Open HiHat	215	Maracas		
54	Rock Snare 1	135	Std2 CHHat	216	Maracas 2		
55	Rock Snare 2	136	Std2 PHHat	217	Syn1 Maracas		
56	Elec.Snare 1	137	Std2 OHHat	218	ShrtHiWhistl		
57	Elec.Snare 2	138	Std3 CIHiHat	219	LongLoWhistl		
58	Syn1 Snare 1	139	Std3 PdHiHat	220	Short Guiro		
59	Syn1 Snare 2	140	Std3 OpHiHat	221	Long Guiro		
60	Syn2 Snare 1	141	HipHop CHHat	222	Claves		
61	Syn2 Snare 2	142	HipHop PHHat	223	Claves 2		
62	TranceSnare1	143	HipHop OHHat	224	Syn1 Claves		
63	TranceSnare2	144	Rock CIHiHat	225	Hi WoodBlock		
64	Dance Snare1	145	Rock PdHiHat	226	LowWoodBlock		
65	DanceSnar1Gt	146	Rock OpHiHat	227	Mute Cuica		
66	Dance Snare2	147	Syn1CIHiHat1	228	Open Cuica		
67	Dance Snare3	148	Syn1CIHiHat2	229	MuteTriangle		
68	Dance Snare4	149	Syn1 OpHiHat	230	OpenTriangle		
69	Dance Snare5	150	Syn2CIHiHat1	231	MuteTriangl2		
70	Dance Snare6	151	Syn2CIHiHat2	232	OpenTriangl2		
71	Dance Snare7	152	Syn2 OpHiHat	233	Shaker		
72	Dance Snare8	153	Trc ClsHiHat	234	Shaker 2		
73	Dance Snare9	154	Trc OpHiHat1	235	Jingle Bell		
74	Techno Snare	155	Trc OpHiHat2	236	Bell Tree		
75	Jazz Snare 1	156	CrashCymbal1	237	Castanets		
76	Jazz Snare 2	157	CrashCymbal2	238	Mute Surdo		
77	Brush Snare	158	RockCrashCym	239	Open Surdo		
78	Brush Slap	159	ChineseCymb	240	Applause 1		
79	Brush Swirl	160	SplashCymbal	241	Applause 2		
80	Concert SD	161	RockSplshCym	242	Timpani F		





**CASIO®**

**CASIO COMPUTER CO., LTD.**  
6-2, Hon-machi 1-chome  
Shibuya-ku, Tokyo 151-8543, Japan

MA1309-B



© 2013 CASIO COMPUTER CO., LTD.