

PL-40R

USER'S GUIDE

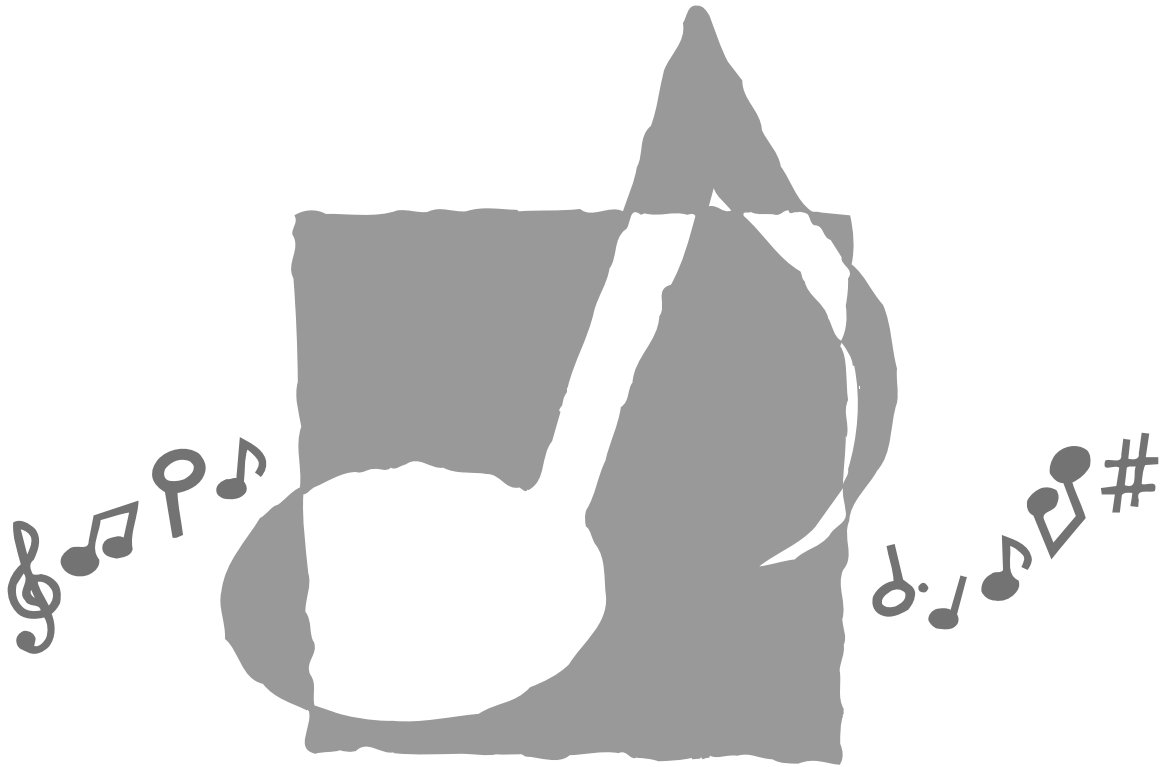

NOTICE

This equipment has been tested and found to comply with the limits for a Class B digital device, pursuant to Part 15 of the FCC Rules. These limits are designed to provide reasonable protection against harmful interference in a residential installation. This equipment generates, uses and can radiate radio frequency energy and, if not installed and used in accordance with the instructions, may cause harmful interference to radio communications. However, there is no guarantee that interference will not occur in a particular installation. If this equipment does cause harmful interference to radio or television reception, which can be determined by turning the equipment off and on, the user is encouraged to try to correct the interference by one or more of the following measures:

- Reorient or relocate the receiving antenna.
- Increase the separation between the equipment and receiver.
- Connect the equipment into an outlet on a circuit different from that to which the receiver is connected.
- Consult the dealer or an experienced radio/TV technician for help.

FCC WARNING

Changes or modifications not expressly approved by the party responsible for compliance could void the user's authority to operate the equipment.

TO REDUCE THE RISK OF FIRE OR ELECTRIC SHOCK, REFER SERVICING TO QUALIFIED SERVICE PERSONNEL.

Important!

Please note the following important information before using this product.

- Before using the optional AD-15ML Adaptor to power the unit, be sure to check the AC Adaptor for any damage first. Carefully check the power cord for breakage, cuts, exposed wire and other serious damage. Never let children use an AC adaptor that is seriously damaged.
- The product is not intended for children under 3 years.
- Use only CASIO AD-15ML adaptor.
- The AC adaptor is not a toy.
- Be sure to disconnect the AC adaptor before cleaning the product.



CASIO ELECTRONICS CO., LTD.
Unit 6, 1000
North Circular Road
London NW2 7JD, U.K.

This mark is valid in the EU countries only.
Please keep all information for future reference.



Safety Precautions

Congratulations on your selection of the CASIO Digital Piano. This piano is a sophisticated musical instrument that blends the very best of traditional piano feel and sound quality with the latest that modern electronics technology has to offer.

- Before using the instrument, be sure to carefully read through the instructions contained in this manual.
- Please keep all information for future reference.

Symbols

Various symbols are used in this user's guide and on the product itself to ensure that the product is used safely and correctly, and to prevent injury to the user and other persons as well as damage to property. Those symbols along with their meanings are shown below.

	WARNING
This indication stipulates matters that have the risk of causing death or serious injury if the product is operated incorrectly while ignoring this indication.	
	CAUTION
This indication stipulates matters that have the risk of causing injury as well as matters for which there is the likelihood of occurrence of physical damage only if the product is operated incorrectly while ignoring this indication.	

Symbol Examples











This triangle symbol () means that the user should be careful. (The example at left indicates electrical shock caution.)







This circle with a line through it () means that the indicated action must not be performed. Indications within or nearby this symbol are specifically prohibited. (The example at left indicates that disassembly is prohibited.)







The black dot () means that the indicated action must be performed. Indications within this symbol are actions that are specifically instructed to be performed. (The example at left indicates that the power plug must be unplugged from the electrical socket.)

 WARNING	
Smoke, Strange Odor, Overheating	
Continued use of the product while it is emitting smoke, a strange odor, or heat creates the risk of fire and electric shock. Take the following steps immediately.	
<ol style="list-style-type: none"> 1. Turn off power. 2. If you are using the AC adaptor for power, unplug it from the wall outlet. 3. Contact your original retailer or an authorized CASIO Service Provider. 	
AC Adaptor	
Misuse of the AC adaptor creates the risk of fire and electric shock. Always make sure you observe the following precautions.	
<ul style="list-style-type: none"> • Be sure to use only the AC adaptor that is specified for this product. 	
<ul style="list-style-type: none"> • Use only a power source whose voltage is within the rating marked on the AC adaptor. 	
<ul style="list-style-type: none"> • Do not overload electrical outlets and extension cords. 	
AC Adaptor	
Misuse of the AC adaptor's electric cord can damage or break it, creating the risk of fire and electric shock. Always make sure you observe the following precautions.	
<ul style="list-style-type: none"> • Never place heavy objects on the cord or subject it to heat. 	
<ul style="list-style-type: none"> • Never try to modify the cord or subject it to excessive bending. 	
<ul style="list-style-type: none"> • Never twist or stretch the cord. 	
<ul style="list-style-type: none"> • Should the electric cord or plug become damaged, contact your original retailer or authorized CASIO Service Provider. 	
AC Adaptor	
<ul style="list-style-type: none"> • Never touch the AC adaptor while your hands are wet. Doing so creates the risk of electric shock. 	
Do not incinerate the product.	
<ul style="list-style-type: none"> • Never throw the product into fire. Doing so can cause it to explode, creating the risk of fire and personal injury. 	





Safety Precautions







 WARNING	
Water and Foreign Matter	
Water, other liquids, and foreign matter (such as pieces of metal) getting into the product create the risk of fire and electric shock. Take the following steps immediately.	
<ol style="list-style-type: none"> 1. Turn off power. 2. If you are using the AC adaptor for power, unplug it from the wall outlet. 3. Contact your original retailer or an authorized CASIO Service Provider. 	
Disassembly and Modification	
Never try to take this product apart or modify it in any way. Doing so creates the risk of electric shock, burn injury, or other personal injury. Leave all internal inspection, adjustment, and maintenance up to your original retailer or authorized CASIO Service Provider.	
Dropping and Impact	
Continued use of this product after it has been damaged by dropping or subjecting it to strong impact creates the risk of fire and electric shock. Take the following steps immediately.	
<ol style="list-style-type: none"> 1. Turn off power. 2. If you are using the AC adaptor for power, unplug it from the wall outlet. 3. Contact your original retailer or an authorized CASIO Service Provider. 	
Plastic Bags	
Never place the plastic bag the product comes in over your head or in your mouth. Doing so creates the risk of suffocation. Particular care concerning this precaution is required where small children are present.	
Never climb onto the product or stand.*	
Never climb onto the product or hang from its edges. Doing so can cause the product to fall over, creating the risk of personal injury. Special care concerning this point is required in households where there are small children.	

 WARNING	
Do not locate the product on an unstable surface.	
Never locate the product on a surface that is wobbly, tilted, or otherwise unstable*. An unstable surface can cause the product to fall over, creating the risk of personal injury.	
<p>★ Avoid areas where there are multiple layers of carpeting, and where cables are running under the product.</p> <p>Always make sure you secure the product to the stand with the screws that are provided. An unsecured product can fall from the stand, creating the risk of personal injury.</p>	

 CAUTION	
AC Adaptor	
Misuse of the AC adaptor creates the risk of fire and electric shock. Always make sure you observe the following precautions.	
<ul style="list-style-type: none"> ◆ Do not locate the electric cord near a stove or other sources of heat. ◆ Never pull on the cord when unplugging from the electrical outlet. Always grasp the AC cord plug when unplugging. 	
AC Adaptor	
Misuse of the AC adaptor creates the risk of fire and electric shock. Always make sure you observe the following precautions.	
<ul style="list-style-type: none"> ◆ Insert the AC cord into the wall outlet as far as it will go. ◆ Unplug the AC cord from the wall outlet during lightning storms or before leaving on a trip or other long-term absence. ◆ At least once a year, unplug the AC cord from the wall outlet and wipe away any dust that is built up in the area around the prongs of the plug. 	
AC Adaptor	
When in use, do not locate the AC adaptor inside a bookcase or other confined space, and never place paper, books, or other similar objects on the AC adaptor.	

Safety Precautions

 CAUTION	
Relocating the Product	
Before relocating the product, always unplug the AC cord from the wall outlet and disconnect all other cables and connecting cords. Leaving cords connected creates the risk of damage to the cords, fire, and electric shock.	
Cleaning	
Before cleaning the product, always unplug the AC cord from the wall outlet first. Leaving the AC adaptor plugged in creates the risk of damage to the AC adaptor, fire, and electric shock.	
Connectors	
Connect only the specified devices and equipment to the product's connectors. Connection of a non-specified device or equipment creates the risk of fire and electric shock.	
Location	
Avoid the following locations for this product. Such locations create the risk of fire and electric shock.	
<ul style="list-style-type: none"> ◆ Areas subject to high humidity or large amounts of dust ◆ In food preparation areas or other areas subject to oil smoke ◆ Near air conditioning equipment, on a heated carpet, in areas exposed to direct sunlight, inside of a vehicle parked in the sun, or any other area that subjects the product to high temperatures 	
Liquid Crystal Display (LCD) Precautions	
<ul style="list-style-type: none"> ◆ Avoid subjecting the piano's LCD to strong impact, which can crack or break the LCD's glass creating the danger of personal injury. ◆ Should the LCD glass ever crack or break, do not allow the liquid inside the LCD to come into contact with your skin, which can cause inflammation and reddening. <p style="margin-left: 20px;">* Should the LCD liquid get into your mouth, immediately wash out your mouth with water and then consult a physician.</p>	

 CAUTION	
* Should the LCD liquid get in your eyes or on your skin, immediately flush with water for at least 15 minutes and then consult a physician.	
Sound Volume	
Do not listen to music at very loud volumes for long periods. Particular care concerning this precaution is required when using headphones. High volume settings can damage your hearing.	
Health Precaution	
In extremely rare cases, exposure to strong sudden light or flashing light can cause momentary muscle spasms, loss of consciousness, or other physical problems with some individuals.	
<ul style="list-style-type: none"> ◆ If you suspect that you might be susceptible to any condition such as this, be sure to consult with your physician before using this product.  ◆ Use this product in an area that is well illuminated.  ◆ Should you ever feel any symptoms similar to those described above when using this product, stop using it immediately and contact your physician.  	
Heavy Objects	
Never place heavy object on top of the product. Doing so can make the product top heavy, causing the product to tip over or the object to fall from it, creating the risk of personal injury.	
Correct Stand* Assembly	
Failure to do so can cause the stand to fall over and the digital piano to fall from the stand, creating the risk of personal injury. Make sure you assemble the stand in accordance with the instructions that come with it, and ensure that all connections are secure. Also make sure that you choose an appropriate location for the stand.	
<ul style="list-style-type: none"> ◆ When placing the digital piano onto the stand, take care that you do not pinch your fingers between the digital piano and the stand. 	

Safety Precautions



CAUTION

- ◆ At least two people should lift the digital piano when placing it onto the stand or moving it. Trying to move the digital piano alone can cause the stand to fall over, creating the risk of personal injury.
- ◆ Do not drag the stand or tilt it forward or back when placing the digital piano onto the stand or moving it. Doing so can cause the digital piano to fall over, creating the risk of personal injury.
- ◆ Periodically check the screws that secure the digital piano to the stand for looseness. If a screw is loose, retighten it. Loose screws can cause the stand to tip over and the digital piano to fall, creating the risk of personal injury.

* Stand is available as an option.

IMPORTANT SAFETY INSTRUCTIONS

WARNING – When using electric products, basic precautions should always be followed, including the following:

- ◆ Read these instructions.
- ◆ Keep these instructions.
- ◆ Heed all warnings.
- ◆ Follow all instructions.
- ◆ Do not use this apparatus near water.
- ◆ Clean only with dry cloth.
- ◆ Do not install near any heat sources such as radiators, heat registers, stoves, or other apparatus (including amplifiers) that produce heat.
- ◆ Protect the power cord from being walked on or pinched particularly at plugs, convenience receptacles, and the point where they exit from the apparatus.
- ◆ Only use attachments/accessories specified by the manufacturer.
- ◆ Unplug this apparatus during lightning storms or when unused for long periods of time.
- ◆ Refer all servicing to qualified service personnel. Servicing is required when the apparatus has been damaged in any way, such as power-supply cord or plug is damaged, liquid has been spilled or objects have fallen into the apparatus, the apparatus has been exposed to rain or moisture, does not operate normally, or has been dropped.

Main Features

■ Simple, compact design

A simple, compact design fits right in and complements just about any interior layout.

■ Advanced Lesson System (pages E-35, 39)

Choose from among 70 built-in auto accompaniment tunes for your listening pleasure, or turn off the melody or another part and practice by playing along.

The lesson function lets you select one of three different arrangement levels to suit your abilities and need. Simply select the part you want to practice, and then follow along on the keyboard as keys light. First master the timing. Next, play along at your own pace. Finally, you can try playing along with the accompaniment at normal speed.

■ Big display with a wealth of musical information (page E-12)

A big, information-packed display shows you which fingers to use, which keys to press, staff notation of the notes being played, and much more.

■ Sequencer (page E-53)

A 17-track sequencer provides a System Track for recording of the auto accompaniment plus 16 tracks, each of which can be used to record with a different tone.

■ 100 rhythms (page E-23)

100 preset rhythms including rock, pops, jazz, and much more are at your fingertips.

■ Auto Accompaniment (page E-23)

Simply play a chord, and the corresponding rhythm, bass, and chords parts play along automatically. One Touch Presets instantly recalls the most suitable tone and tempo settings to match the rhythm you are using.

■ 271 realistic tones (page E-18, 71)

A simple operation selects one of 271 TONE button tones, including "Grand Piano", "Vibraphone", and much more.

A Sound Quality Adjustment feature lets you select the optimal sound quality setting to match the environment and acoustic conditions of the location where you are playing.

■ General MIDI compatibility (page E-66)

General MIDI compatible tones let you connect to a personal computer for quick and easy "desktop music" capabilities, which means you can use the piano as a desktop music input device or sound source.

■ Mixer (page E-46)

You can specify tone, volume, pan position, and other parameters for each built-in auto accompaniment part and each track recorded with the sequencer. You can also control the same parameters for each channel during MIDI input.

■ Effects (page E-33)

The piano's powerful effector provides three blocks: DSP + Chorus + Reverb. A different effect can be assigned to each block, and blocks can be turned on and off as required.

■ Registration Memory (page E-50)

Keyboard setups can be stored in memory for later recall and instant settings whenever you need them. Up to 16 setups (4 setups × 4 banks) can be stored in registration memory.



Contents

Safety Precautions E-1

Main Features E-5

Contents E-6

General Guide E-9

About the DisplayE-12

**Connecting to
a Power Outlet E-14**

Using the AC AdaptorE-14

Power On Alert.....E-15

Settings and Memory Contents.....E-15

Connections E-16

Accessories and OptionsE-16

Basic Operations

Basic Operations E-18

Getting StartedE-18

Selecting a ToneE-18

Upper1, Upper2, Lower1, Lower2E-19

Using LayerE-19

Using SplitE-20

Using Layer and Split Together.....E-20

Turning the Key Light System
On and Off.....E-21

Using the PedalsE-21

**Auto Accompaniment
..... E-22**

About the MODE Button.....E-22

Selecting a RhythmE-23

Playing a Rhythm E-23

Using Auto Accompaniment..... E-23

Adjusting the Tempo E-26

Adjusting the Accompaniment
Volume E-26

Using an Intro Pattern E-26

Using a Fill-in Pattern E-27

Using the Variation Patterns..... E-27

Using a Break..... E-27

Using Synchro Start E-27

Finishing with an Ending Pattern..... E-28

Using Auto Harmonize E-29

Using One-touch Preset..... E-30

Using the Metronome E-30

Transposing the Piano E-31

Tuning the Piano E-31

Using Touch Response E-32

**Applying Effects to Tones
..... E-33**

Effect Blocks..... E-33

Configuring Effect Settings..... E-33

**Using the Advanced Lesson
System to Play Back a Music
Library Tune E-35**

Selecting a Tune E-35

Playing a Tune E-36

Adjusting the Tempo E-36

Pausing Playback..... E-37

Skipping Back..... E-37

Skipping Forward E-37

Looping a Musical Phrase.....E-37

Using the Advanced Lesson System to Practice Along with a Music Library Tune E-39

Arrangement LevelsE-39

Selecting the Part You Want to PracticeE-39

3-Step LessonE-40

Step 1 – Master the timing.E-40

Step 2 – Master the melody.E-41

Voice Fingering Guide.....E-42

Step 3 – Play at normal speed.....E-42

Changing the Lesson Part ToneE-43

Advanced Operations

Using the Mixer E-46

Parts.....E-46

Changing the Parameters of a Part.....E-47

Mixer Parameters.....E-48

Registration Memory E-50

Registration Memory Features.....E-50

To save a setup in registration memory.....E-51

To recall a setup from registration memoryE-52

Using the Sequencer E-53

How the Sequencer Works..... E-53

Sequencer Main Menus and Sub Menus E-56

Realtime Recording..... E-57

Modifying Recorded Data with Punch In Recording E-59

Changing Song Header Data E-60

Playing Back from Sequencer Memory..... E-60

Configuring Global Recording Settings and Operations..... E-61

Using MIDI E-66

What is MIDI?..... E-66

Sending and Receiving MIDI Messages..... E-67

MIDI Settings..... E-68

Connecting to a Computer E-69

USB Mode and MIDI Mode E-69

Obtaining USB Driver Upgrades and the Latest PL-40R Information E-70

Keyboard Settings E-71

Using the Keyboard Setup Menus..... E-71

Parameter Setting Items..... E-73

Contents

Reference

***Troubleshooting* E-84**

***Specifications* E-87**

***Operational Precautions*
..... E-90**

***Appendix* A-1**

Tone ListA-1

Drum Assignment ListA-7

Rhythm ListA-10

Effect TableA-11

Fingered/Full Range Chord TableA-12

Song ListA-15

Parameter List.....A-17

***MIDI Data Format* A-22**

Channel MessagesA-22

System Messages.....A-31

***Index* A-40**

MIDI Implementation Chart

General Guide

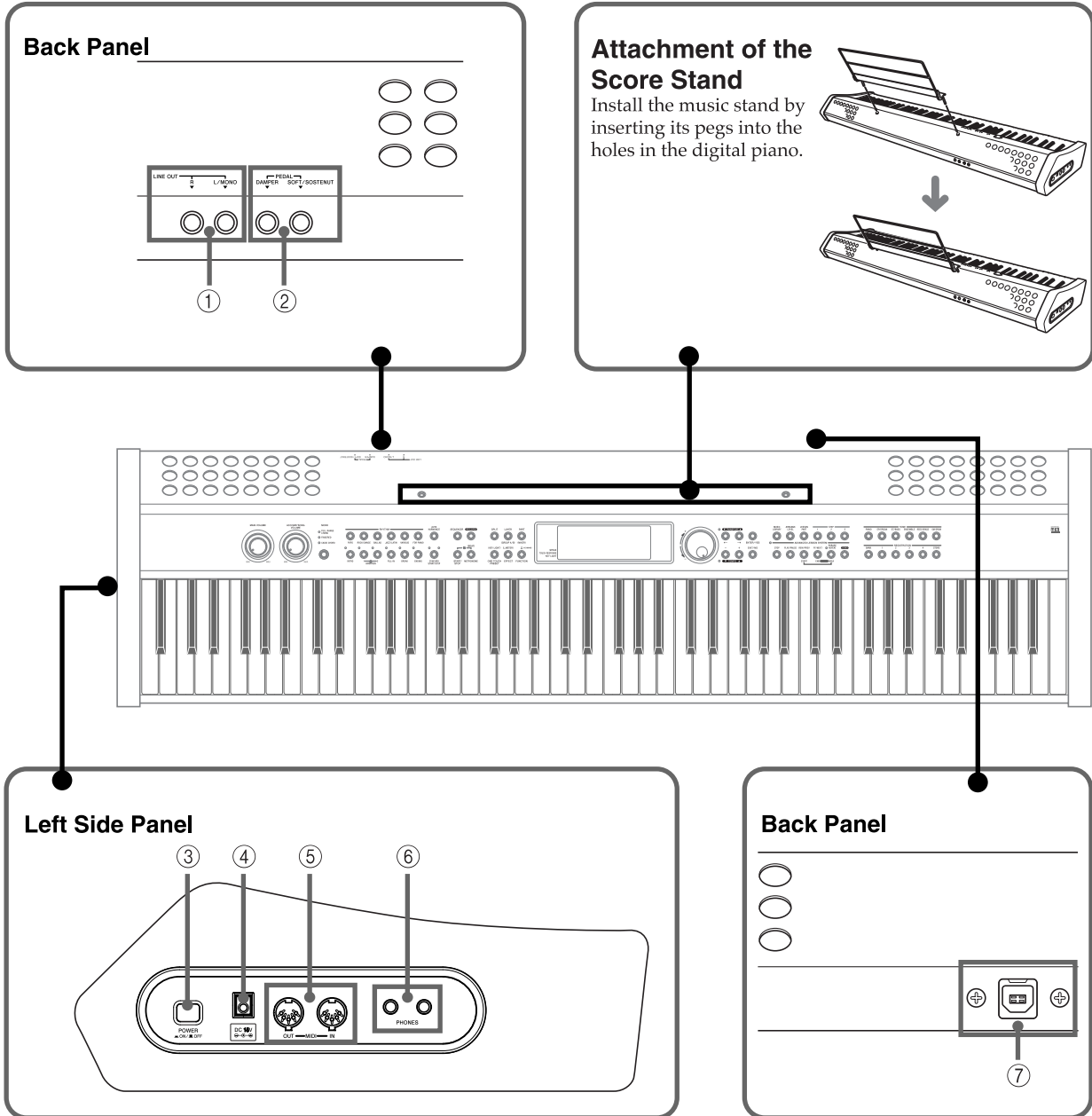

- ① LINE OUT jacks (R, L/MONO)
- ② DAMPER PEDAL jack, SOFT/SOSTENUTO PEDAL jack
- ③ POWER button
- ④ DC 15V jack
- ⑤ MIDI IN terminal, MIDI OUT terminal
- ⑥ PHONES jack
- ⑦ USB port

General Guide

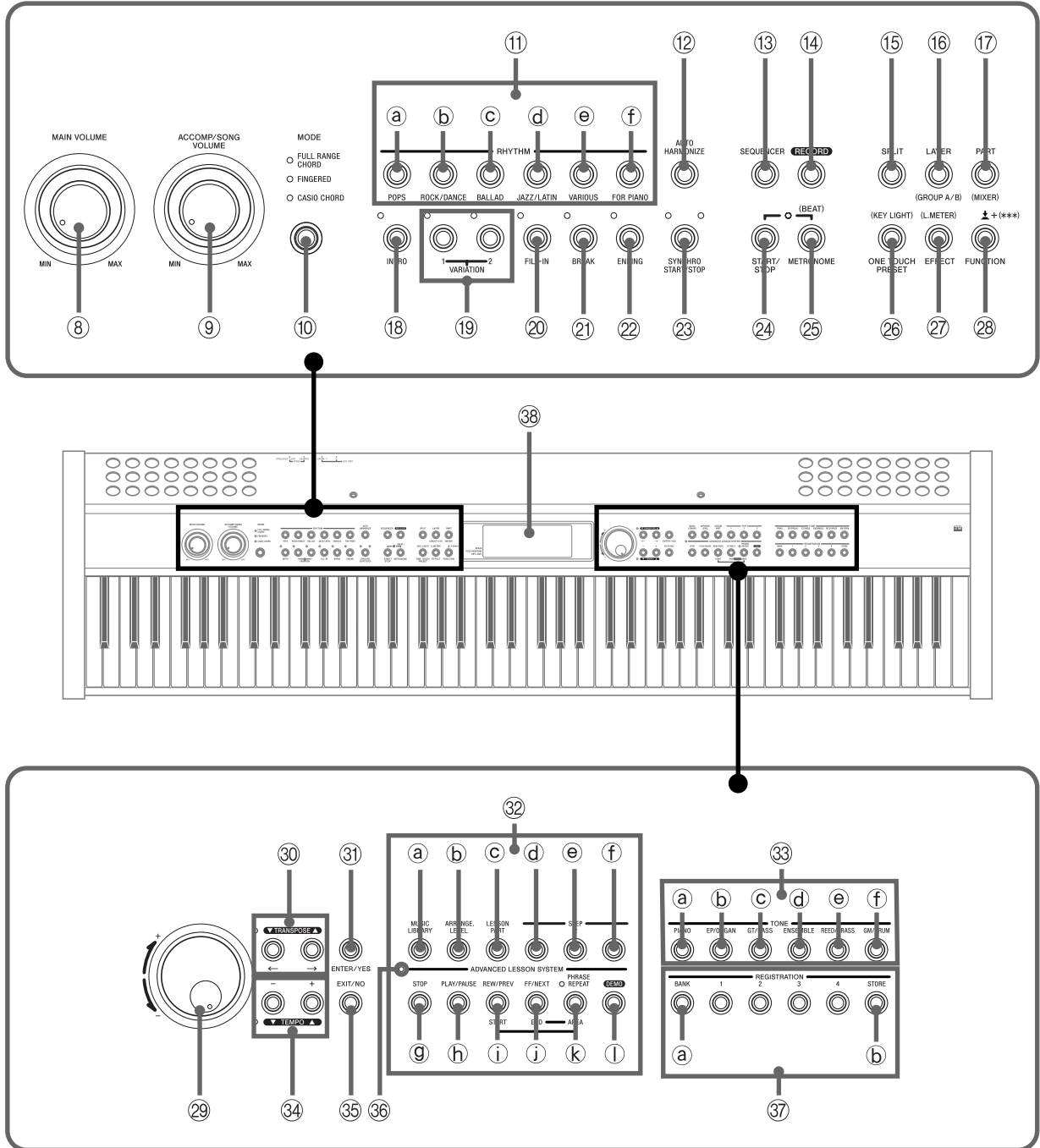

- ⑧ MAIN VOLUME knob
- ⑨ ACCOMP/SONG VOLUME knob
- ⑩ MODE button
- ⑪ RHYTHM buttons
- Ⓐ POPS button
- Ⓑ ROCK/DANCE button

- Ⓒ BALLAD button
- Ⓓ JAZZ/LATIN button
- Ⓔ VARIOUS button
- Ⓕ FOR PIANO button
- ⑫ AUTO HARMONIZE button
- ⑬ SEQUENCER button
- ⑭ RECORD button

General Guide

- ⑮ SPLIT button
- ⑯ LAYER/(GROUP A/B) button
- ⑰ PART/(MIXER) button
- ⑱ INTRO button
- ⑲ VARIATION 1/2 buttons
- ⑳ FILL-IN button
- ㉑ BREAK button
- ㉒ ENDING button
- ㉓ SYNCHRO START/STOP button
- ㉔ START/STOP button
- ㉕ METRONOME/(BEAT) button
- ㉖ ONE TOUCH PRESET/(KEY LIGHT) button
- ㉗ EFFECT/(L. METER) button
- ㉘ FUNCTION/ \updownarrow + (***) button
- ㉙ Selector dial
- ㉚ TRANSPOSE buttons [\blacktriangle]/[\blacktriangledown], [\leftarrow]/[\rightarrow] buttons
- ㉛ ENTER/YES button
- ㉜ ADVANCED LESSON SYSTEM
 - Ⓐ MUSIC LIBRARY button
 - Ⓑ ARRANGE. LEVEL button
 - Ⓒ LESSON PART button
 - Ⓓ STEP 1 button
- Ⓔ STEP 2 button
- Ⓕ STEP 3 button
- Ⓖ STOP button
- Ⓗ PLAY/PAUSE button
- Ⓘ REW/PREV button, START button
- Ⓚ FF/NEXT button, END button
- Ⓛ PHRASE REPEAT button, AREA button
- ① DEMO button*
- ③③ TONE buttons
 - Ⓐ PIANO button
 - Ⓑ EP/ORGAN button
 - Ⓒ GT/BASS button
 - Ⓓ ENSEMBLE button
 - Ⓔ REED/BRASS button
 - Ⓕ GM/DRUM button
- ④ TEMPO buttons [\blacktriangle]/[\blacktriangledown], [+]/[-] buttons
- ⑤ EXIT/NO button
- ⑥ Music Library Mode lamp
- ⑦ REGISTRATION buttons
 - Ⓐ BANK button
 - Ⓑ STORE button
- ⑧ Display

NOTE

Note Names

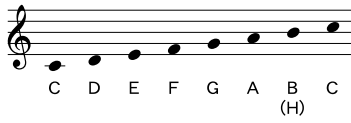

C D E F G A B C
(H)

A value next to a note name indicates the relative position of the note on the keyboard as shown below.

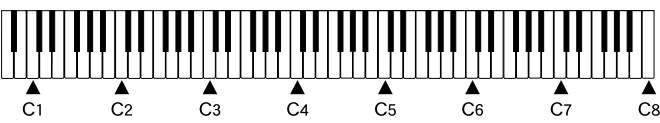

C1 C2 C3 C4 C5 C6 C7 C8

* Playing a Demo Tune

1. Press the DEMO button to start demo tune play.
 - ◆ This causes the indicator lamp above the MUSIC LIBRARY button to light.
 - ◆ Demo tune play plays all of the songs in the Music Library, starting from the first song, in an endless loop. Songs in the user group, however, are not played. (See the "Song List" on page A-15.)
 - ◆ You can use the [+] and [-] buttons or the selector dial to change the currently playing demo tune.
 - ◆ You can also use the [\leftarrow] and [\rightarrow] buttons to change the Music Library group.
2. To stop demo tune play, press the DEMO button or the START/STOP button.

NOTE

- ◆ You can play along with a demo tune on the keyboard using the tone setting of the demo tune.
- ◆ MIDI/USB is disabled while a demo tune is playing.

General Guide

About the Display

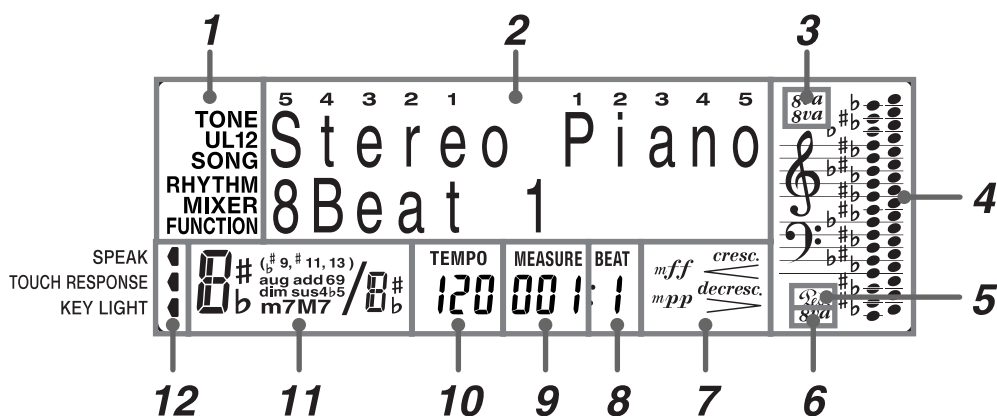

1. Operation Indicators

These indicators show what type of settings you are making and the type of information currently displayed in the message area. The applicable indicator appears while you are making tone (TONE), part (U1, U2, L1, L2), song (SONG), rhythm (RHYTHM), mixer (MIXER), or function (FUNCTION) settings.

2. Message area

This area shows the currently selected tone name (and number when a General MIDI tone is selected), rhythm name, or song number and name. You can determine the type of information that is currently displayed by checking the current operation indicator **1**. This area is also used to display other types of information, depending on the mode. During lessons and while playing along with built-in tunes, this area shows keyboard fingerings and fingering numbers.

3. Octave symbol 1

One symbol indicates the note being produced by the keyboard is one octave higher than the note shown in the staff notation area **4**. Two symbols indicate two octaves higher.

4. Staff notation area

Notes you play on the keyboard, lesson part notes, notes played back from memory, chord forms, and received MIDI data are shown here.

5. Pedal mark

The pedal mark appears when you depress the pedal, and during a lesson to indicate you should press the pedal.

6. Octave symbol 2

This symbol indicates the note being produced by the keyboard is one octave lower than the note shown in the staff notation area **4**.

7. Dynamics symbols

These indicators appear during lessons and while playing along with built-in tunes to show the relative strength of a note.

8. Beat number

Shows the beat number during rhythm and auto accompaniment play, and while the Advanced Lesson System or sequencer is turned on.

9. Measure

Shows the measure number from the start of play during rhythm and auto accompaniment play, and while the Advanced Lesson System or sequencer is turned on.

10. Tempo indicator

Shows the tempo as a value indicating the number of beats per minute during rhythm and auto accompaniment play, and while the Advanced Lesson System or sequencer is turned on.

General Guide

11. Chord name display

Shows chord names while auto accompaniment is being used.

12. Pointers

A pointer appears next to the applicable function when you have voice fingering guide, touch response, or key lighting turned on.

NOTE

- Display examples shown in this User's Guide are intended for illustrative purposes only. The actual text and values that appear on the display may differ from the examples shown here.

Level Meter Screen

Under certain conditions, you can display a digital level meter screen. The level meter has 16 segments, divided between two lines of eight segments each. Besides showing the volume level of each part that is turned on, the level meter also indicates the current on/off status of each track. During Sequencer playback standby, the level meter can be used to check which track has data stored in it.

NOTE

You can display the level meter in the following cases.

- While the tone/rhythm screen is on the display
- In the Music Library Mode
- During sequencer playback standby
- During sequencer playback

■ To display the level meter

1. While holding down the FUNCTION button, press the EFFECT/(L. METER) button.

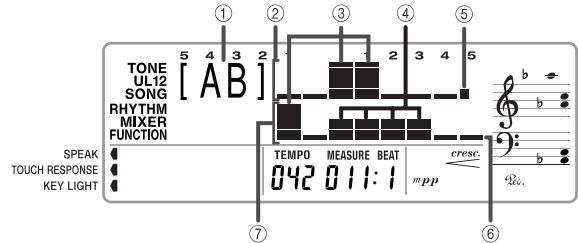

- ① Currently selected mixer group
- ② Upper row
- ③ High level
- ④ Low level
- ⑤ Indicates part is off or does not exist
- ⑥ Indicates part is on
- ⑦ Lower row

2. Hold down the FUNCTION button and press the LAYER/(GROUP A/B) button to cycle through the mixer group settings.

- The information being displayed in the upper row and lower row of the level meter depends on the currently selected mixer group (page E-46), as shown below.

* [A] Group A (Internal)

The upper level meter row shows this:
Upper 1, Upper 2, Lower 1, Lower 2,
Harmonize 1, Harmonize 2

The lower level meter row shows this:
Percussion, Bass, Chord 1, Chord 2, Chord 3,
Chord 4, Chord 5

* [B] Group B (External)

The upper level meter row shows this:
Part 1 through Part 8

The lower level meter row shows this:
Part 9 through Part 16

* [AB]

Displaying the level meter screen while in the Music Library Mode displays the parts of both mixer groups (A and B).

3. To exit the level meter display, press the EXIT/NO button.

Connecting to a Power Outlet

You can power this digital piano by plugging it into a standard household power outlet. Be sure you turn off power and unplug the power cord from the electrical outlet whenever the digital piano is not in use.

Using the AC Adaptor

Make sure that you use only the AC adaptor specified for this digital piano.

Connecting the AC Adaptor

1. Plug the AC power cord into the AC adaptor.
2. Plug the AC power cord into a household electrical wall outlet.
3. Plug the adaptor cord into the power terminal (DC-15V) on the back of the digital piano.

Specified AC Adaptor: AD-15ML

[Left Side Panel]

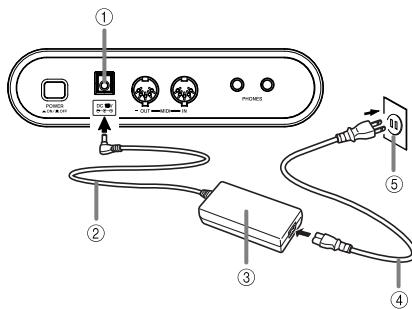





- ① DC 15V jack
- ② Adaptor cord
- ③ AC Adaptor AD-15ML
- ④ AC cord
- ⑤ AC outlet

Also note the following important warnings and precautions when using the AC adaptor.



⚠ WARNING

Misuse of the AC adaptor creates the risk of fire and electric shock. Always make sure you observe the following precautions.

- Be sure to use only the AC adaptor and AC cord that is specified for this product. 
- Use only a power source whose voltage is within the rating marked on the AC adaptor.
- Do not overload electrical outlets and extension cords. 
- Never place heavy objects on the cord or subject it to heat. 
- Never try to modify the cord or subject it to excessive bending.
- Never twist or stretch the cord.
- Should the electric cord or plug become damaged, contact your original retailer or authorized CASIO Service Provider. 
- Never touch the AC adaptor while your hands are wet. Doing so creates the risk of electric shock. 

⚠ CAUTION

Misuse of the AC adaptor creates the risk of fire and electric shock. Always make sure you observe the following precautions.

- Do not locate the electric cord near a stove or other sources of heat. 
- Never pull on the cord when unplugging from the electrical outlet. Always grasp the AC cord plug when unplugging.
- Insert the AC cord into the wall outlet as far as it will go. 
- Unplug the AC cord from the wall outlet during lightning storms or before leaving on a trip or other long-term absence.
- At least once a year, unplug the AC cord from the wall outlet and wipe away any dust that is built up in the area around the prongs of the plug.

IMPORTANT!

- Make sure that the product is turned off before connecting or disconnecting the AC adaptor.
- Using the AC adaptor for a long time can cause it to become warm to the touch. This is normal and does not indicate malfunction.

Connecting to a Power Outlet

Power On Alert

Keyboard keys light to alert you if you leave power on and do not perform any operation for about 6 minutes. Note that keys light only, and no sound is produced. When this happens, press any button or keyboard key to clear the power on alert.

To disable power on alert

See "Keyboard Settings" on page E-71 for information about disabling power on alert.

- ◆ When this function is turned off, the piano does not turn off automatically and no alert is performed no matter how long it is left with no operation being performed.

Settings and Memory Contents

The following describes what happens to settings and memory contents when power is turned off.

Settings

When you turn off the piano by pressing the POWER button, it "remembers" the current settings of certain parameters. These settings remain in effect the next time you turn on the piano.

For information on which parameters the piano remembers, see the "Power Off Backup Items" of the "Parameter List" at the back of this manual (page A-17).

Memory Contents

In addition to the settings described above, the digital piano also retains registration memory and sequencer contents when power is turned off.

Power Requirements

The piano comes with a built-in lithium battery that supplies power to the memory to retain sequencer and other data while piano power is turned off. If the power of the lithium battery is low, turning off piano power can result in deletion of all data stored in its memory.

The normal life of the original battery is five years from the time it is loaded at the factory. Due to time spent in transit and storage, the original battery probably will not provide a full five years of service life. It is up to you to contact your nearest CASIO service provider about having the lithium battery replaced periodically.

Note that you will be charged separately for lithium battery replacement.

Initializing the Piano

Use the procedure on page E-81 to initialize the digital piano, which clears all memory data and returns settings to their initial factory defaults.

Connections

Connecting to an audio or musical instrument amplifier provides even clearer, more powerful sound through external speakers.

Left Side

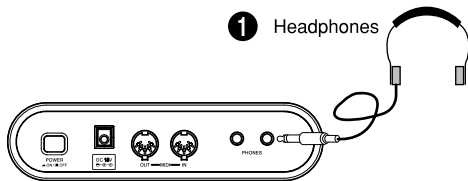

Back

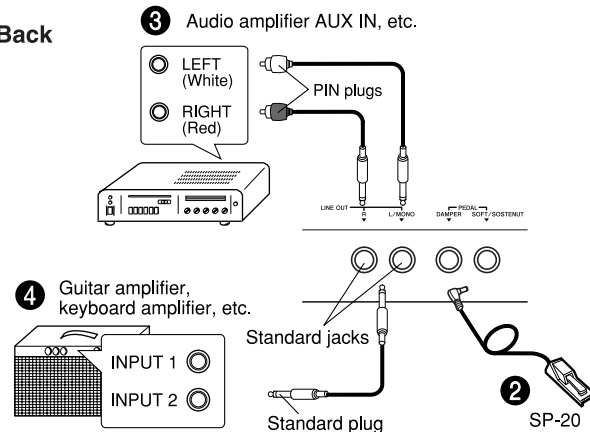

IMPORTANT!

- Whenever connecting external equipment, first set the MAIN VOLUME knob of the digital piano and the volume controller of the external equipment to relatively low volume settings. You can later adjust volume to the level you want after connections are complete.
- Be sure also to refer to the documentation that comes with the external equipment for its proper connection procedures.

Connecting Headphones ①

Connect commercially available headphones to the digital piano's headphones jack. This cuts off the built-in speakers, which means you can practice even late at night without disturbing others. To protect your hearing, make sure that you do not set the volume level too high when using headphones.

Connecting to a PEDAL Jack ②

Depending on the type of operation you want the pedal (SP-20) to perform, connect the pedal's cable to the digital piano's DAMPER jack or SOFT/SOSTENUTO jack. If you want to use both jacks at the same time, you need to purchase another optionally available SP-20 pedal. See "Using the Pedals" on page E-21 for information about using a pedal.

Connecting to Audio Equipment ③

Use commercially available cables to connect the external audio equipment to the digital piano's LINE OUT jacks as shown in Figure ③. R jack output is right channel sound, while L/MONO jack output is left channel sound. It is up to you to purchase connecting cables like the ones shown in the illustration for connection of audio equipment. Normally in this configuration you must set the audio equipment's input selector to the setting that specifies the terminal (such as AUX IN) to which the digital piano is connected. Use the digital piano's MAIN VOLUME knob to adjust the volume level.

Connecting to a Musical Instrument Amplifier ④

Use commercially available cables to connect the amplifier to the digital piano's LINE OUT jacks as shown in Figure ④. R jack output is right channel sound, while L/MONO jack output is left channel sound. Connecting to the L/MONO jack only outputs a mixture of both channels. It is up to you to purchase connecting cable like the one shown in the illustration for connection of the amplifier. Use the digital piano's MAIN VOLUME knob to adjust the volume level.

Accessories and Options

Use only the accessories and options specified for this digital piano. Use of non-authorized items creates the danger of fire, electric shock, and personal injury.

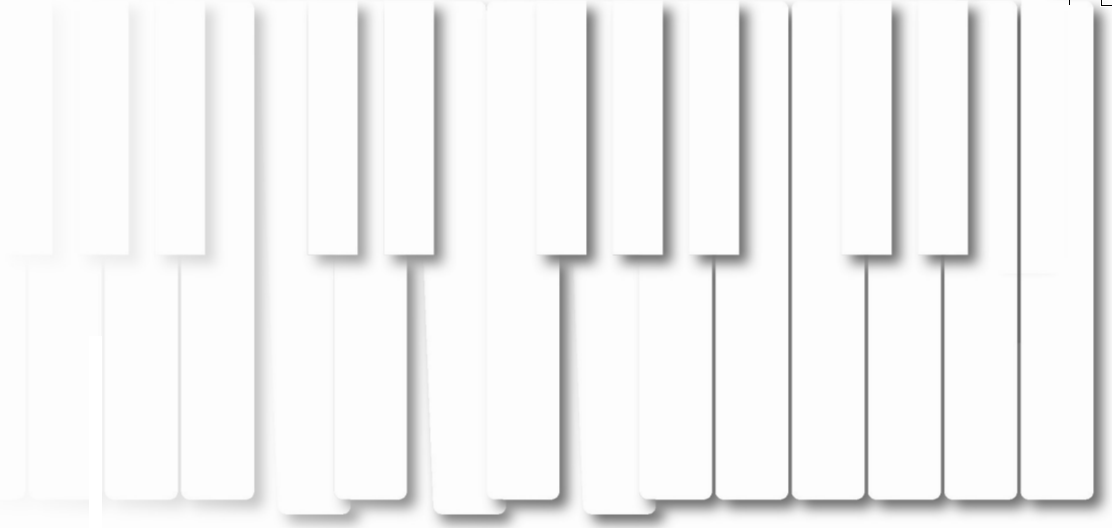

Basic Operations

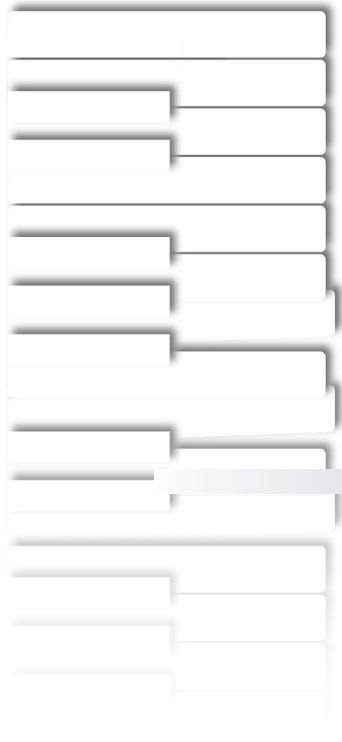

Basic Operations

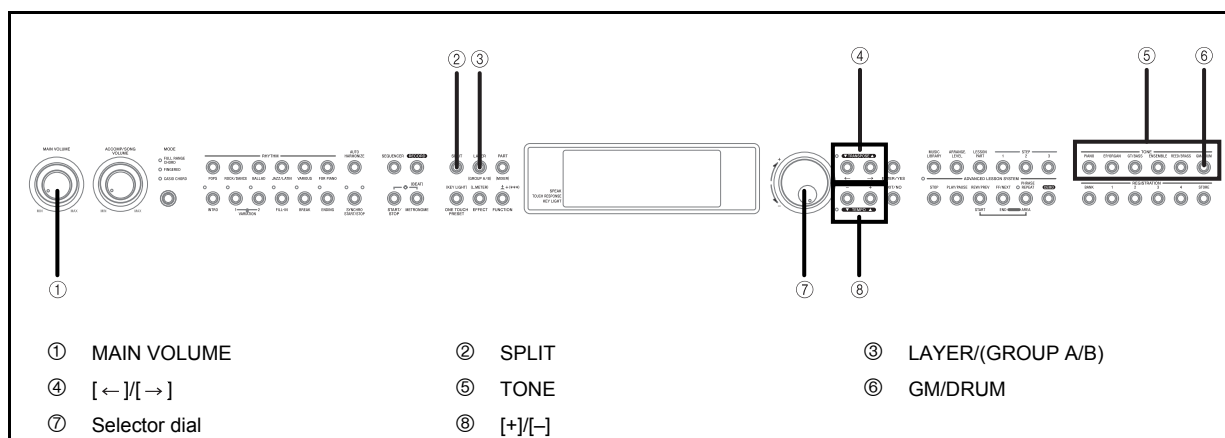

This section provides information on performing basic piano operations.

Getting Started

To play the piano

1. Press the POWER button to turn on the piano.
2. Use the MAIN VOLUME knob to set the volume to a relatively low level.
3. Play something on the keyboard.

Selecting a Tone

The built-in tones are divided among 6 groups, with each group assigned to a TONE button on the control panel.

To select a tone

1. See the “Tone List” at the back of this manual (page A-1) for information about the TONE button names for each of the built-in tones.
2. Press the TONE button of the tone you want to select.
 - ◆ This causes the button’s indicator lamp to light, and displays the tone that is currently selected for that button.

Example:

To select “Bright Piano”, first press the PIANO button.



3. Use the [←]/[→] buttons to select the tone you want.

Example:

For this example, press [→] button four times.



- ◆ You can also change the tone setting by rotating the selector dial.
- ◆ The display exits the tone setting screen if you do not perform any operation for about 10 seconds. You can also exit the tone setting screen by pressing the EXIT/NO button.

NOTE

- ◆ The GRAND PIANO tone was recorded using stereo sampling.
- ◆ When one of the drum sets is selected (tone numbers 261 through 270), each keyboard key is assigned a different percussion sound. See page A-7 for details.

Polyphony

The term polyphony refers to the maximum number of notes you can play at the same time. This piano has 64-note polyphony, which includes the notes you play as well as the rhythms and auto-accompaniment patterns that are played by the piano. This means that when a rhythm or auto-accompaniment pattern is being played by the piano, the number of notes (polyphony) available for keyboard play is reduced. Also note that some of the tones provide only 32-note polyphony.

Digital Sampling

A number of the tones that are available with this piano have been recorded and processed using a technique called digital sampling. To ensure a high level of tonal quality, samples are taken in the low, mid, and high ranges and then combined to provide you with sounds that are amazingly close to the originals. You may notice very slight differences in volume or sound quality for some tones when you play them at different positions on the keyboard. This is an unavoidable result of multiple sampling, and it is not a sign of malfunction.

Upper1, Upper2, Lower1, Lower2

This piano lets you use up to four parts simultaneously for your performances. The parts are named Upper1, Upper2, Lower1, and Lower2, and the display shows the tone currently assigned to each.

You can use the PART/(MIXER) button to display the tones that are assigned for each part (Upper1, Upper2, Lower1, Lower2). Each press of PART/(MIXER) button cycles through the parts in the sequence shown below. While a part is displayed, you can change the tone assigned to it (page E-18).

♦ Upper1	U 1
♦ Upper2	U 2
♦ Lower1	L1
♦ Lower2	L 2

Using Layer

With layer you can assign two different tones (a main tone and a layered tone) to the keyboard, both of which play whenever you press a key.

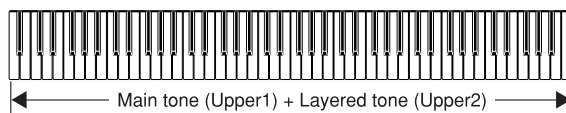

To layer two tones

1. Select the main tone.
2. Press the LAYER/(GROUP A/B) button to turn on tone layering.
 - ♦ This causes the indicator lamp of the button to light.
 - ♦ The currently layered tone name appears on the display. You can use the TONE buttons to change the layered tone if you want.
3. Select the layered tone.
4. Now try playing something on the keyboard.
 - ♦ Both tones are played at the same time.
5. Press the LAYER/(GROUP A/B) button again to unlayer the tones and return the keyboard to normal.
 - ♦ This causes the indicator lamp of the button to go out.

NOTE

- ♦ Layering is disabled during demo tune play and in the Music Library Mode (while Music Library Mode lamp is lit).
- ♦ Layering is achieved by sounding Upper1 and Upper2 of mixer Group A. This means you can use the mixer to change the volume balance and stereo pan position parameters for both the main tone and layered tone. See "Using the Mixer" on page E-46 for details.

Basic Operations

Using Split

With split you can assign two different tones (a main tone and a split tone) to either end of the keyboard, which lets you play one tone with your left hand and another tone with your right hand.

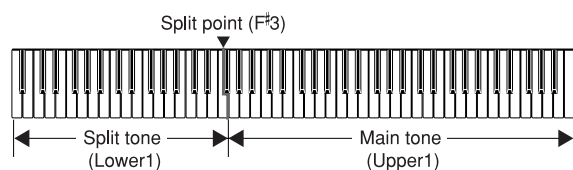

To split the keyboard

1. Select the main tone.
2. Press the SPLIT button.
 - ◆ This causes the indicator lamp of the button to light.
 - ◆ The current split tone name appears on the display. You can use the TONE buttons to change the split tone if you want.
3. Select the split tone.
4. Now try playing something on the keyboard.
 - ◆ The lower range (left side) of the keyboard is assigned the split tone, while the upper range (right side) is assigned the main tone.
 - ◆ The location on the keyboard where the changeover between the two tones occurs is called the split point. See "To change the location of the split point" on this page for details on changing the location of the split point.
5. Press the SPLIT button again to unsplit the keyboard and return it to normal.
 - ◆ This causes the indicator lamp of the button to go out.

NOTE

- ◆ Split is disabled during demo tune play and in the Music Library Mode (while Music Library Mode lamp is lit).
- ◆ Split is achieved by sounding Upper1 and Lower1 of mixer Group A. This means you can use the mixer to change the volume balance and stereo pan position parameters for both the main tone and split tone. See "Using the Mixer" on page E-46 for details.

To change the location of the split point

While holding down the SPLIT button, press the keyboard key where you want the lowest note (the leftmost key) of the upper range (right side range) to be.

- ◆ No sound is produced when the keys are pressed.

Using Layer and Split Together

You can use layer and split together to create a layered/split keyboard. When you use layer and split in combination, the high range of the keyboard is assigned two tones (main tone + layered tone), and the low range two tones (split tone + layered/split tone).

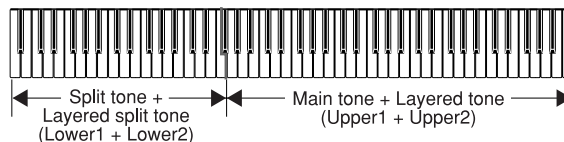

To layer/split the keyboard

1. Select the main tone, layered tone, split tone, and layered/split tone.
 - ◆ Use the mixer to select the tones, following the procedure under "Changing the Parameters of a Part" on page E-47. The main tone is Upper1, the layered tone is Upper2, the split tone is Lower1, and the layered/split tone is Lower2.
2. Turn on both layer and split to layer/split the keyboard.
 - ◆ Press the LAYER/(GROUP A/B) button once to turn on layer.
 - ◆ Press the SPLIT button to turn on split.
 - ◆ This causes the indicator lamps of both the buttons to light.
 - ◆ The layered/split tone name appears on the display. You can change the layered/split tone if you want.
3. Now try playing something on the keyboard.
4. Press the LAYER/(GROUP A/B) button and the SPLIT button again to unlayer/unsplit the keyboard and return it to normal.

NOTE

- Layer/split is produced by using mixer Group A Upper1, Upper2, Lower1, and Lower2 at the same time. This means you can use the mixer to change the volume balance and stereo pan position parameters for each of the tones. See "Using the Mixer" on page E-46 for details.
- You can use the mixer to turn off individual channels (layer/split tones). This means you could turn off Lower2, for example, to sound a single tone in the lower range and two layered tones in the upper range. See page E-46 for details.

Turning the Key Light System On and Off

Use the following procedure when you want to turn the key light system on or off.

1. While holding down the FUNCTION button, press the ONE TOUCH PRESET/(KEY LIGHT) button to toggle the key light system on and off.
 - The pointer next to KEY LIGHT appears when the key lighting system is turned on, and disappears when it is turned off.

Using the Pedals

The digital piano is equipped with two pedal jacks, one for a damper pedal and one for a soft/sostenuto pedal. Use the "Assign Left" setting described under "Setting: Pedal" on page E-77 to assign the function you want to the SOFT/SOSTENUTO jack. The power on default setting of the SOFT/SOSTENUTO jack is SOFT.

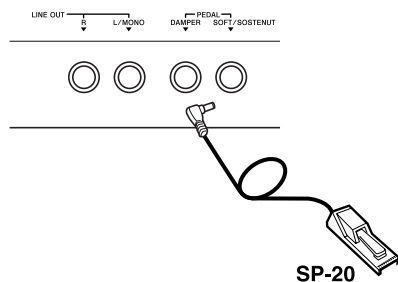

Pedal functions

- **Damper pedal**
Pressing this pedal causes notes to reverberate and to sustain longer.
- **Soft pedal**
Pressing this pedal dampens notes and slightly reduces their volume. Only notes played after the pedal is depressed are affected, and any notes played before the pedal is pressed sound at their normal volume.
- **Sostenuto pedal**
Like the damper pedal, this pedal causes notes to reverberate and to sustain longer. The difference between the two pedals is the timing when they are pressed. With the sostenuto pedal, you press the pedal after depressing the notes you want to sustain. Only the notes whose keyboard keys are depressed when the sostenuto pedal is pressed are affected.

NOTE

- During memory playback and demo tune play, pedal effects are applied to notes played on the keyboard only.

Auto Accompaniment

① MODE	② RHYTHM	③ AUTO HARMONIZE
④ Selector dial	⑤ TRANSPOSE [▲]/[▼]	⑥ INTRO
⑦ VARIATION 1/2	⑧ FILL-IN	⑨ BREAK
⑩ ENDING	⑪ SYNCHRO START/STOP	⑫ START/STOP
⑬ METRONOME/(BEAT)	⑭ ONE TOUCH PRESET/ (KEY LIGHT)	⑮ FUNCTION
⑯ [+]/[-]	⑰ TEMPO [▲]/[▼]	

This piano automatically plays bass and chord parts in accordance with the chords you finger. The bass and chord parts are played using sounds and tones that are automatically selected to match the rhythm you are using. All of this means that you get full, realistic accompaniments for the melody notes you play with your right hand, creating the mood of an one-person ensemble.

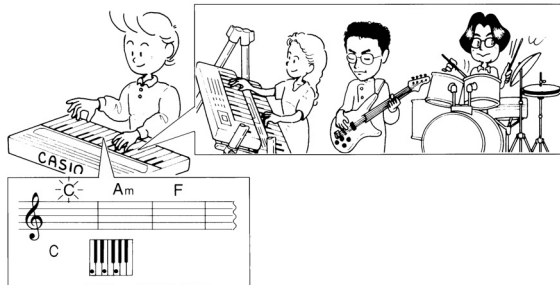

About the MODE Button

Use the MODE button to select the accompaniment mode you want to use. Each press of the MODE button cycles through the available accompaniment modes as shown in the illustration below.

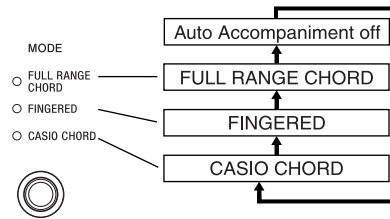

- ◆ Only rhythm sounds are produced when all accompaniment mode lamps are off.
- ◆ The currently selected accompaniment mode is shown by the mode lamps above the MODE button. Information on using each of these modes starts from page E-24.

Auto Accompaniment

Selecting a Rhythm

The built-in rhythms are divided among 6 groups, with each group assigned to a RHYTHM button on the control panel.

To select a rhythm

1. See the Rhythm Reference at the back of this manual (page A-10) for information about the RHYTHM button names for each of the built-in rhythms.
2. Press the RHYTHM button of the rhythm you want to select.
 - ◆ This causes the button's indicator lamp to light, and displays the rhythm that is currently selected for that button.

Example:

To select "Samba 1", first press the JAZZ/LATIN button.



- ① Rhythm Group
- ② Rhythm Name

3. Use the [←]/[→] buttons to select the rhythm you want.

Example:

For this example, press [→] button eight times.

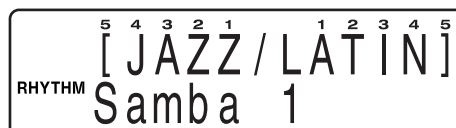

- ◆ You can also change the rhythm setting by rotating the selector dial.
- ◆ The display exits the rhythm setting screen if you do not perform any operation for about 10 seconds. You can also exit the rhythm setting screen by pressing the EXIT/NO button.

NOTE

- ◆ Some rhythms consist of chord accompaniments only, without any drums or other percussion instruments. Such rhythms do not sound unless CASIO CHORD, FINGERED, or FULL RANGE CHORD is selected as the

accompaniment mode. Make sure the applicable indicator lamp is lit above the MODE button when using these rhythms.

Playing a Rhythm

Press the START/STOP button to start play of the currently selected rhythm. You can then play along with the rhythm on the keyboard.

To stop rhythm play, press the START/STOP button again.

NOTE

- ◆ Chords will sound along with the rhythm if any of the three accompaniment mode lamps above the MODE button is lit. If you want to play the rhythm pattern without chords, press the MODE button until all of the accompaniment mode lamps are off.

Using Auto Accompaniment

The following procedure describes how to use the piano's auto accompaniment feature. Before starting, you should first select the rhythm you want to use and set its tempo to the value you want.

To use Auto Accompaniment

1. Use the MODE button to select FULL RANGE CHORD, FINGERED, or CASIO CHORD as the accompaniment mode.
2. Press the START/STOP button to start play of the currently selected rhythm.
3. Play a chord to start auto accompaniment.
 - ◆ The actual procedure you should use to play a chord depends on the currently selected accompaniment mode. Refer to the following pages for details on chord play.

CASIO CHORD	Page E-24
FINGERED	Page E-25
FULL RANGE CHORD	Page E-25

Auto Accompaniment

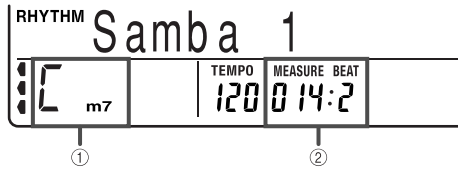

- ① Name of chord being played
- ② Current measure and beat

4. To stop auto accompaniment play, press the START/STOP button again.

CASIO CHORD

This method of chord play makes it possible for anyone to easily play chords, regardless of previous musical knowledge and experience. The following describes the CASIO CHORD “accompaniment keyboard” and “melody keyboard”, and tells you how to play CASIO CHORDs.

CASIO CHORD accompaniment keyboard and melody keyboard

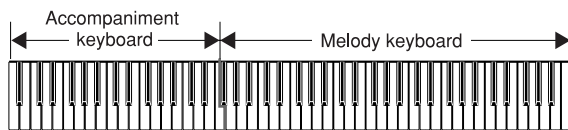

NOTE

- ◆ On the keyboard shown above, Lower1 and Lower2 are assigned to the accompaniment keyboard range and Upper1 and Upper2 are assigned to the melody keyboard range.
- ◆ When split is turned off (page E-20), the accompaniment keyboard range keys do not sound any melody notes. In this case, they are used to specify chords for the accompaniment pattern.
- ◆ You can expand the range of the accompaniment keyboard by moving the keyboard's split point to the right (page E-20).

Chord Types

CASIO CHORD accompaniment lets you play four types of chords with minimal fingering.

Chord Types	Example
<p>Major chords Note that the chord produced when you press an accompaniment keyboard key does not change octave, regardless of which key you use to play it.</p>	<p>C Major (C)</p>
<p>Minor chords (m) To play a minor chord, keep the major chord key depressed and press any other accompaniment keyboard key located to the right of the major chord key.</p>	<p>C minor (Cm)</p>
<p>Seventh chords (7) To play a seventh chord, keep the major chord key depressed and press any other two accompaniment keyboard keys located to the right of the major chord key.</p>	<p>C seventh (C7)</p>
<p>Minor seventh chords (m7) To play a minor seventh chord, keep the major chord key depressed and press any other three accompaniment keyboard keys located to the right of the major chord key.</p>	<p>C minor seventh (Cm7)</p>

NOTE

- ◆ It makes no difference whether you press black or white keys to the right of a major chord key when playing minor and seventh chords.

Auto Accompaniment

FINGERED

In this mode, you specify chords by playing them as you would on a piano, inside the accompaniment keyboard range. To specify a C-chord, you would play C-E-G.

FINGERED accompaniment keyboard and melody keyboard

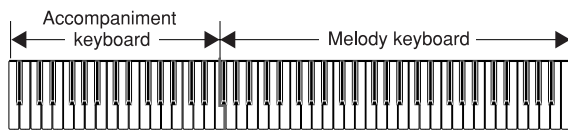

NOTE

- On the keyboard shown above, Lower1 and Lower2 are assigned to the accompaniment keyboard range and Upper1 and Upper2 are assigned to the melody keyboard range.
- When split is turned off (page E-20), the accompaniment keyboard range keys do not sound any melody notes. In this case, they are used to specify chords for the accompaniment pattern.
- You can expand the range of the accompaniment keyboard by moving the keyboard's split point to the right (page E-20).

Recognized Chords

See the "Fingered/Full Range Chord Table" at the back of this manual (page A-12) for information about the chords that can be recognized in the Fingered Mode.

- The chords that are recognized by the keyboard in the FINGERED Mode depend on the current "On Bass Chord", "6th Chord", and "Tension Chord" Accompaniment settings. See "Keyboard Settings" on page E-71 for information about Accompaniment settings. Information about how settings affect the type of chords recognized by the keyboard can be found "Fingered/Full Range Chord Table" at the back of this manual (page A-12).

NOTE

- In the FINGERED Mode, you can use standard fingering (C-E-G for a C-chord, for example) or you can use inverted fingerings (G-E-C, for example), as long as you play chords within the accompaniment keyboard range. Note, however, that using an inverted fingering will produce a different chord entirely if the "On Bass Chord" Accompaniment setting is turned on.
- Generally, you must press all of the keys that make up chords. Omitting a note or playing only a single note will not produce a chord.

FULL RANGE CHORD

This mode can be used to play up to 238 different types of chords. Pressing three or more keys in a pattern that is recognized as a chord pattern by the keyboard causes the corresponding chord to be played. Playing chords in a pattern not recognized by the keyboard or pressing two keys or one key causes the corresponding notes to be played as melody notes. This means that the entire range of the keyboard acts as both a melody keyboard and accompaniment keyboard.

FULL RANGE CHORD accompaniment keyboard and melody keyboard

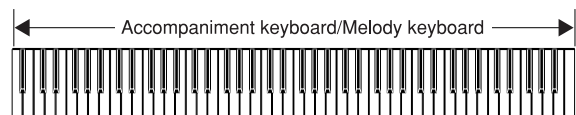

Recognized Chords

See the "Fingered/Full Range Chord Table" at the back of this manual for more information (page A-12).

Example:

To play the chord C major.

Either of the fingerings shown in the illustration below will produce C major.

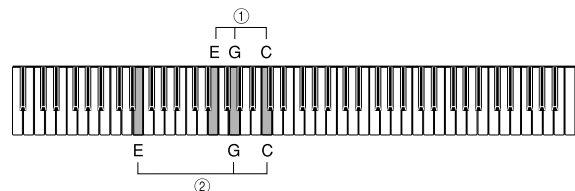

- ① Chord C
- ② Chord $\frac{C}{E}$

NOTE

- If there are more than six semitones between the lowest note and the next note to the right, the lowest note is interpreted as a bass note.

Auto Accompaniment

Adjusting the Tempo

You can adjust the tempo (number of beats per minute) of rhythm play within a range of 30 to 255.

To adjust the tempo

- While the indicator lamp above the TEMPO buttons is lit, use the TEMPO buttons [▲]/[▼] to adjust the tempo.
 - The TEMPO button indicator lamp is not lit and tempo adjustment cannot be performed while the menu screen is on the display. To exit the menu screen and return to the tone/rhythm screen, press the FUNCTION button.
- [▲] (+) Increase tempo (make it faster)
 [▼] (-) Decrease tempo (make it slower)



- You can also change the tempo setting by rotating the selector dial.

NOTE

- Pressing both TEMPO buttons [▲] and [▼] at the same time resets the tempo to the default value of the currently selected rhythm.
- The tempo value indicates the number of quarter note beats per minute.

Adjusting the Accompaniment Volume

You can adjust the volume of the accompaniment part separately from the overall volume.

- Use the ACCOMP/SONG VOLUME knob to adjust the accompaniment volume.

Using an Intro Pattern

This piano lets you insert a short intro into a rhythm pattern to make startup smoother and more natural.

Getting Ready

- Select a rhythm and set its tempo.
- Select the accompaniment mode you want to use.

To insert an intro

- Press the INTRO button to start the selected rhythm with an intro pattern.
 - With the above setup, the intro pattern is played and the auto accompaniment with intro pattern starts as soon as you play chords on the accompaniment keyboard.

NOTE

- The standard rhythm pattern starts to play after the intro pattern is complete.

Auto Accompaniment

Using a Fill-in Pattern

Fill-in patterns let you momentarily change the rhythm pattern to add some interesting variation to your performances.

To insert a fill-in

1. Press the START/STOP button to start rhythm play.
2. Press the FILL-IN button to insert a fill-in pattern for the rhythm you are using.

Using the Variation Patterns

Each rhythm/auto accompaniment pattern has two different variations. You can vary the mood of your music by switching to a different variation while rhythm/auto accompaniment play is in progress.

Getting Ready

- Select a rhythm and adjust its tempo.
- Use the MODE button to specify the chord fingering mode you want to use.
- Listen to the two variations available for the rhythm you are using to get some idea of what they sound like.

1. Press the START/STOP button to start rhythm play.
 - It does not make any difference which VARIATION 1/2 button is depressed at first.
2. Press another VARIATION button to switch to a different variation of the same rhythm.
 - When you press a VARIATION button the change to the new rhythm variation is performed in time with the beat of the rhythm.

Using a Break

A break inserts a moment of silence into a rhythm/auto accompaniment pattern. Pressing the BREAK button stops the rhythm/auto accompaniment pattern until the beginning of the next measure, when the pattern starts to play again.

Using Synchro Start

Synchro Start lets you set up the keyboard so rhythm and chord accompaniment starts automatically when you press keys inside the accompaniment keyboard range.

Getting Ready

- Select a rhythm and adjust its tempo.
- Use the MODE button to specify the chord fingering mode you want to use.

1. While the rhythm is not playing yet, press the SYNCHRO START/STOP button.
 - This causes the left lamp above the button to light, indicating that the keyboard is in synchro start standby.
2. Press one of the VARIATION 1/2 buttons to select the rhythm variation you want to start with.
3. Play a chord in the accompaniment keyboard range.
 - Both rhythm and chord accompaniment starts at the same time. The lamp above the SYNCHRO START/STOP button goes out when the rhythm/auto accompaniment starts.

NOTE

- Only the rhythm sounds if no lamp above the MODE button is lit.
- If you press the INTRO button so the lamp above it is lit before step 2 of the above procedure, playing a chord causes accompaniment to start after the corresponding intro pattern is played.
- Pressing the SYNCHRO START/STOP button again while the keyboard is in synchro start standby exits synchro start standby, which causes the lamp above the SYNCHRO START/STOP button to go out.

Auto Accompaniment

Using Synchro Start/Stop while Auto Accompaniment is Playing

Synchro stop is the opposite of synchro start. It causes the currently playing auto accompaniment pattern to stop when the keys in the accompaniment keyboard range are released. This feature is more than just a simple way to stop auto accompaniment play. It plays auto accompaniment only when valid chords are played inside the accompaniment keyboard range.

IMPORTANT!

- The following procedures do not work in the normal Mode, when all lamps above the MODE button are turned off.

Using Synchro Stop to stop Auto Accompaniment

Getting Ready

- Select a rhythm and adjust its tempo.
- Use the MODE button to specify the chord fingering mode you want to use.

1. Press the START/STOP button to start play of the selected rhythm.
2. Press the SYNCHRO START/STOP button.
 - This causes the right lamp above the button to light, indicating that the keyboard is in synchro stop standby.
3. Play a chord in the accompaniment keyboard range and then release the keys.
 - This causes the auto accompaniment pattern to stop playing and both lamps above the SYNCHRO START/STOP button to light, indicating that the keyboard is in synchro stop.
 - To exit synchro stop, press the SYNCHRO START/STOP button twice so the two lamps go out.
 - The section below describes what auto accompaniment operations you can perform while the keyboard is in synchro stop.

Auto Accompaniment in Synchro Stop

The following are the auto accompaniment operations you can perform while the keyboard is in synchro stop (both lamps above the SYNCHRO START/STOP button lit).

- Playing a chord in the accompaniment keyboard range causes auto accompaniment to play (only while the chord note keys are depressed). Releasing the keys causes auto accompaniment play to stop, and the keyboard enters synchro stop again.
- Pressing the SYNCHRO START/STOP button while playing a chord in the accompaniment keyboard range causes the lamps above the button to go out, indicating that the keyboard is no longer in synchro stop.

With synchro stop, you can easily create a break in auto accompaniment play to allow for ad libbing, and then restart accompaniment when you want.

Finishing with an Ending Pattern

You can end your performances with an ending pattern that brings the rhythm you are using to a natural-sounding conclusion.

To finish with an ending pattern

1. While the rhythm is playing, press the ENDING button.
 - This causes the ending pattern to play, which brings rhythm accompaniment to an end.

NOTE

- The timing when the ending pattern starts depends on when you press the ENDING button. If you press the button before the second beat of the current measure, the ending pattern starts playing immediately. Pressing the button at any point in the measure after the second beat results in the ending pattern playing from the beginning of the following measure.

Auto Accompaniment

Using Auto Harmonize

When you are using auto accompaniment, auto harmonize automatically adds an additional note to your melody in accordance with the chord that is being played. The result is a harmony effect that makes your melody line richer and fuller.

To use Auto Harmonize

1. Use the MODE button to select FINGERED or CASIO CHORD as the accompaniment mode.

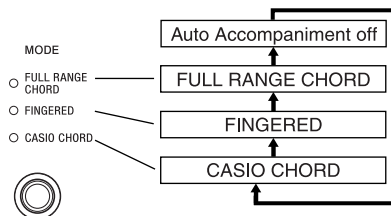

2. Press the AUTO HARMONIZE button to turn on auto harmonize.
 - This causes the button's indicator lamp to light, indicating that auto harmonize is turned on.
 - At this point you could use the [←] and [→] buttons or the selector dial to select the type of auto harmonize you want to use. See "Auto Harmonize Types" below for more information.

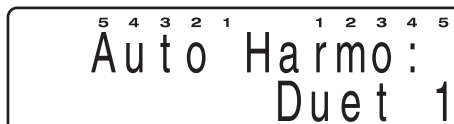

- The display exits the auto harmonize setting screen if you do not perform any operation for about 10 seconds. You can also exit the auto harmonize setting screen by pressing the EXIT/NO button.
3. Start auto accompaniment play, and play something on the keyboard.
 - Harmonize notes are added automatically to the notes you play in the melody keyboard range.
 4. To turn off auto harmonize, press the AUTO HARMONIZE button again.
 - This causes the button's indicator lamp to go out, indicating that auto harmonize is turned off.

NOTE

- If you have two tones (Upper1, Upper2) layered on the keyboard, harmonize notes are added to both.
- Auto harmonize is enabled only when the auto accompaniment mode is FINGERED or CASIO CHORD.

Auto Harmonize Types

You can select from among the 12 different types of auto harmonize listed below.

Type (parameter Name)	Description
Duet1	Adds a 1-part harmony to keyboard play.
Duet2	Adds a 1-part harmony to keyboard play. Duet2 harmony is more open than Duet1.
Country	Adds a country-flavor harmony to keyboard play.
Octave	Adds notes one octave below notes played on the keyboard.
5th	Adds fifth notes above notes played on the keyboard.
3-Way Open	Adds two open harmony parts to notes played on the keyboard (creating three-part harmony).
3-Way Close	Adds two close harmony parts to notes played on the keyboard (creating three-part harmony).
Strings	Adds harmony suitable for strings.
4-Way Open	Adds three open harmony parts to notes played on the keyboard (creating four-part harmony).
4-Way Close	Adds three close harmony parts to notes played on the keyboard (creating four-part harmony).
Block	Adds block chord notes.
Big Band	Adds harmony suitable for big band play.

You can use the following procedure to select an auto harmonize type using the [←]/[→] buttons or the selector dial, immediately after turning on auto harmonize.

Auto Accompaniment

About Auto Harmonize notes and tones

The notes you play on the keyboard are called “melody notes”, while the notes added to the melody by auto harmonize are called the “harmonize notes”. Auto harmonize normally uses the tone you selected for the melody notes as the tone for the harmonize notes, but you can use the mixer (page E-46) to specify a different tone for the harmonize notes. Harmonize tones correspond to mixer auto harmonize 1 and 2. This means you can specify the harmonize tones by changing the tones assigned to auto harmonize 1 and 2. In addition to the tone, you can also use the mixer to change a number of other parameters, such as volume balance. See “Changing the Parameters of a Part” on page E-47 for details on these procedures.

NOTE

- The default harmonize note tone when you first turn on auto harmonize is the same tone as the melody note tone.
- Changing the melody tone setting automatically changes the harmonize note tone to the same setting.

Using One-touch Preset

One-touch preset automatically makes the settings listed below in accordance with the rhythm pattern you are using.

- Keyboard tone and volume
- Layer or Split on/off
- Layered tone and volume (when layer is turned on), or split tone (when split is turned on)
- Tempo
- Effects
- Harmonize (Type, on/off)

To use one-touch preset

1. Select the rhythm you want to use.
2. Use the MODE button to select the accompaniment mode you want to use.
3. Press the ONE TOUCH PRESET/(KEY LIGHT) button.
 - This automatically makes the one-touch preset settings in accordance with the rhythm you selected.
4. Start rhythm and auto accompaniment, and play something on the keyboard.
 - Accompaniment is played using the one touch preset settings.

Using the Metronome

The metronome feature of this piano produces a bell sound for the first beat of each measure, followed by click sounds for each successive beat of the measure. It is the perfect tool for practicing tunes without accompaniment (rhythm).

To start the metronome

1. While holding down the FUNCTION button, press the METRONOME/(BEAT) button.

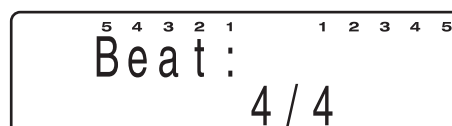

2. Use the [←] and [→] buttons to select the beat setting you want.
 - You can also change the beat setting by rotating the selector dial.

NOTE

- The bell (indicating the first beat of a measure) does not sound while “0” is specified. All beats are indicated by a click sound. This setting lets you practice with a steady beat, without worrying about how many beats there are in each measure.
- Available choices for the meter are 0, 2/4 to 7/4, plus 9/4, 12/4, 3/8, 5/8, 6/8, 7/8, 9/8, or 12/8 time.
- The display exits the metronome setting screen if you do not perform any operation for about 10 seconds. You can also exit the metronome setting screen by pressing the EXIT/NO button.

3. Press the METRONOME/(BEAT) button to start sounding the metronome.
 - The lamp above the START/STOP button flashes in time with the metronome beat.
4. While the indicator lamp above the TEMPO buttons is lit, use the TEMPO buttons [▲]/[▼] to adjust the tempo.
 - The TEMPO button indicator lamp is not lit and tempo adjustment cannot be performed while the menu screen is on the display. To exit the menu screen and return to the tone/rhythm screen, press the FUNCTION button.

[▲] (+) Increase tempo (make it faster)

[▼] (-) Decrease tempo (make it slower)

Auto Accompaniment

- To turn off the metronome, press the METRONOME/(BEAT) button.

Transposing the Piano

Transpose lets you raise and lower the overall key of the piano in semitone units. If you want to play accompaniment for a vocalist whose sings in a specific key, for example, you can use transpose to change the key of the piano without having to learn to play the song in another key.

To transpose the piano

- While the indicator lamp above the TRANSPOSE buttons is lit, use the TRANSPOSE buttons [▲]/[▼] to change the transpose setting.
 - The TRANSPOSE button indicator lamp is not lit and transpose adjustment cannot be performed while the menu screen is on the display. To exit the menu screen, press the FUNCTION button.

Example:

To transpose the piano five semitones upwards.



- You can change the setting on the transpose setting screen using the [←] and [→] buttons or the selector dial.
- Note that the display exits the transpose setting screen if you do not change the setting within 10 seconds after displaying it. To exit the transpose setting screen, press the EXIT/NO button.

NOTE

- The piano can be transposed within a range of -12 (one octave downwards) to +12 (one octave upwards).
- To return the transpose setting its initial default of "0", display the transpose screen and press the [▲] and [▼] buttons at the same time.
- The transpose setting also affects the sequencer and auto accompaniment. It does not, however, affect auto accompaniment drum parts.

Tuning the Piano

The tuning feature lets you fine tune the piano to match the tuning of another musical instrument.

To tune the piano

- Press the FUNCTION button.
- Use the [←] and [→] buttons or the selector dial to display the "Tune" menu screen.
- Press the ENTER/YES button once to display the tuning screen.

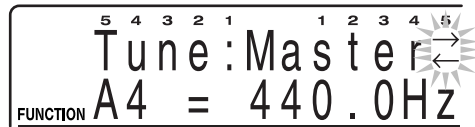

- Use [+] and [-] to change the tuning setting of the piano.

Example:

To lower the tuning by 10.

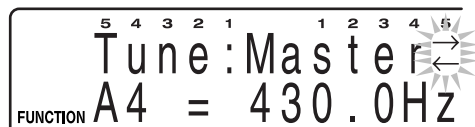

- You can also change the tuning setting by rotating the selector dial.

NOTE

- The piano can be tuned within a range of 415.3Hz to 466.2Hz (± 100 cents*).
 - * 100 cents is equivalent to one semitone.
- To return the tuning setting to its initial default of 440.0Hz, display the tuning screen and press the [+] and [-] buttons at the same time.
- The tuning setting also affects the sequencer and auto accompaniment.
- When you have baroque pitch turned on, the tuning range becomes 390.6Hz to 441.5Hz. In this case, holding down the [+] and [-] buttons at the same time sets an initial default value of 415.3Hz.

Auto Accompaniment

Using Touch Response

Turning on touch response causes the volume and sound quality of piano output to change in accordance with the amount of pressure applied to the keyboard.

To set the touch response sensitivity

1. Press the FUNCTION button.
2. Use the [←] and [→] buttons or the selector dial to display the “General” menu screen.
3. Press the ENTER/YES button once to display the touch response setting screen.

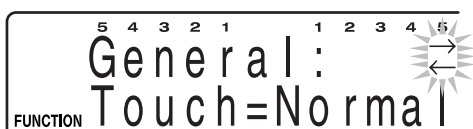

4. Use the [+] and [-] buttons to scroll through the sensitivity settings in the following sequence.
 - “Light” outputs powerful sound even with light key pressure, while “Heavy” requires very heavy key pressure to output powerful sound.
 - Pressing the [+] and [-] buttons at the same time returns sensitivity to the “Normal” setting.
 - You can also change the touch response setting by rotating the selector dial.

NOTE

- Touch response operations affect the piano’s internal sound source as well as MIDI OUT data.
- Touch response settings do not affect sequencer playback, accompaniment, or MIDI note data received from an external source.
- Touch response affects different tones in different ways.