



ESF

MA-170

**USER'S GUIDE
GUÍA DEL USUARIO
MODE D'EMPLOI**



MA170-ESF-1

CASIO®



GUIDELINES LAID DOWN BY FCC RULES FOR USE OF THE UNIT IN THE U.S.A. (not applicable to other areas).

NOTICE

This equipment has been tested and found to comply with the limits for a Class B digital device, pursuant to Part 15 of the FCC Rules. These limits are designed to provide reasonable protection against harmful interference in a residential installation. This equipment generates, uses and can radiate radio frequency energy and, if not installed and used in accordance with the instructions, may cause harmful interference to radio communications. However, there is no guarantee that interference will not occur in a particular installation. If this equipment does cause harmful interference to radio or television reception, which can be determined by turning the equipment off and on, the user is encouraged to try to correct the interference by one or more of the following measures:

- Reorient or relocate the receiving antenna.
- Increase the separation between the equipment and receiver.
- Connect the equipment into an outlet on a circuit different from that to which the receiver is connected.
- Consult the dealer or an experienced radio/TV technician for help.

FCC WARNING

Changes or modifications not expressly approved by the party responsible for compliance could void the user's authority to operate the equipment.

Important Information for Parents!

Parents should please note the following important information before letting children use this product.

- Before using the optional AD-5 Adaptor to power the unit, be sure to check the AC Adaptor for any damage first. Carefully check the power cord for breakage, cuts, exposed wire and other serious damage. Never let children use an AC adaptor that is seriously damaged.
- Never attempt to recharge batteries.
- Do not use rechargeable batteries.
- Never mix batteries of different types.
- Never mix old batteries with new ones.
- Use only the batteries recommended in this manual or equivalent batteries.
- Always make sure that positive (+) and negative (-) poles are facing correctly as indicated near the battery compartment.
- Remove batteries as soon as they show any sign of going dead.
- Do not short-circuit the battery terminals.
- The product is not intended for children under 3 years.
- Use only CASIO AD-5 adaptor.
- The AC adaptor is not a toy.
- Be sure to disconnect the AC adaptor before cleaning the product.



CASIO ELECTRONICS CO., LTD.
Unit 6, 1000
North Circular Road
London NW2 7JD, U.K.

This mark is valid in the EU countries only.
Please keep all information for future reference.

278A-E-002A



Safety Precautions

Congratulations on your selection of the CASIO electronic musical instrument.

- Before using the instrument, be sure to carefully read through the instructions contained in this manual.
- Please keep all information for future reference.

Symbols

Various symbols are used in this user's guide and on the product itself to ensure that the product is used safely and correctly, and to prevent injury to the user and other persons as well as damage to property. Those symbols along with their meanings are shown below.

DANGER

This symbol indicates information that, if ignored or applied incorrectly, creates the danger of death or serious personal injury.

WARNING

This indication stipulates matters that have the risk of causing death or serious injury if the product is operated incorrectly while ignoring this indication.

CAUTION

This indication stipulates matters that have the risk of causing injury as well as matters for which there is the likelihood of occurrence of physical damage only if the product is operated incorrectly while ignoring this indication.

Symbol Examples



This triangle symbol () means that the user should be careful. (The example at left indicates electrical shock caution.)



This circle with a line through it () means that the indicated action must not be performed. Indications within or nearby this symbol are specifically prohibited. (The example at left indicates that disassembly is prohibited.)



The black dot () means that the indicated action must be performed. Indications within this symbol are actions that are specifically instructed to be performed. (The example at left indicates that the power plug must be unplugged from the electrical socket.)



Safety Precautions

DANGER

Alkaline Batteries

Perform the following steps immediately if fluid leaking from alkaline batteries ever gets into your eyes. 

1. Do not rub your eyes! Rinse them with water.
2. Contact your physician immediately.

Leaving alkaline battery fluid in your eyes can lead to loss of sight.

WARNING



Smoke, Strange Odor, Overheating

Continued use of the product while it is emitting smoke, a strange odor, or heat creates the risk of fire and electric shock. Take the following steps immediately.

1. Turn off power.
2. If you are using the AC adaptor for power, unplug it from the wall outlet.
3. Contact your original retailer or an authorized CASIO Service Provider.



AC Adaptor

Misuse of the AC adaptor creates the risk of fire and electric shock. Always make sure you observe the following precautions.

- Be sure to use only the AC adaptor that is specified for this product.
- Use only a power source whose voltage is within the rating marked on the AC adaptor. 
- Do not overload electrical outlets and extension cords. 

AC Adaptor

Misuse of the AC adaptor's electric cord can damage or break it, creating the risk of fire and electric shock. Always make sure you observe the following precautions.

- Never place heavy objects on the cord or subject it to heat. 
- Never try to modify the cord or subject it to excessive bending.
- Never twist or stretch the cord.
- Should the electric cord or plug become damaged, contact your original retailer or authorized CASIO Service Provider. 

AC Adaptor

- Never touch the AC adaptor while your hands are wet. 
- Use the AC adaptor where it will not be splashed with water. Water creates the risk of fire and electric shock.
- Do not place a vase or any other container filled with liquid on top of the AC adaptor. Water creates the risk of fire and electric shock.



Safety Precautions

Batteries

Misuse of batteries can cause them to leak, resulting in damage to nearby objects, or to explode, creating the risk of fire and personal injury. Always make sure you observe the following precautions.

- Never try to take batteries apart or allow them to become shorted.
- Never expose batteries to heat or dispose of them by incineration.
- Never mix old batteries with new ones.
- Never mix batteries of different types.
- Do not charge the batteries.
- Make sure the positive (+) and negative (-) ends of the batteries are facing correctly.



Do not incinerate the product.

Never throw the product into fire. Doing so can cause it to explode, creating the risk of fire and personal injury.



Water and Foreign Matter

Water, other liquids, and foreign matter (such as pieces of metal) getting into the product create the risk of fire and electric shock. Take the following steps immediately.



1. Turn off power.
2. If you are using the AC adaptor for power, unplug it from the wall outlet.
3. Contact your original retailer or an authorized CASIO Service Provider.

Disassembly and Modification

Never try to take this product apart or modify it in any way. Doing so creates the risk of electric shock, burn injury, or other personal injury. Leave all internal inspection, adjustment, and maintenance up to your original retailer or authorized CASIO Service Provider.



Dropping and Impact

Continued use of this product after it has been damaged by dropping or subjecting it to strong impact creates the risk of fire and electric shock. Take the following steps immediately.

1. Turn off power.
2. If you are using the AC adaptor for power, unplug it from the wall outlet.
3. Contact your original retailer or an authorized CASIO Service Provider.



Plastic Bags

Never place the plastic bag the product comes in over your head or in your mouth. Doing so creates the risk of suffocation. Particular care concerning this precaution is required where small children are present.





Safety Precautions

Keep off of the product.

Climbing onto the product can cause it to tip over or become damaged. Particular care concerning this precaution is required where small children are present.



Location

Avoid locating the product on an unstable stand, on an uneven surface, or any other unstable location. An unstable location can cause the product to fall over, creating the risk of personal injury.



CAUTION

AC Adaptor

Misuse of the AC adaptor creates the risk of fire and electric shock. Always make sure you observe the following precautions.

- Do not locate the electric cord near a stove or other sources of heat.
- Never pull on the cord when unplugging from the electrical outlet. Always grasp the AC adaptor when unplugging.



AC Adaptor

Misuse of the AC adaptor creates the risk of fire and electric shock. Always make sure you observe the following precautions.

- Insert the AC adaptor into the wall outlet as far as it will go.
- Unplug the AC adaptor from the wall outlet during lightening storms or before leaving on a trip or other long-term absence.
- At least once a year, unplug the AC adaptor from the wall outlet and wipe away any dust that is built up in the area around the prongs of the plug.



Relocating the Product

Before relocating the product, always unplug the AC adaptor from the wall outlet and disconnect all other cables and connecting cords. Leaving cords connected creates the risk of damage to the cords, fire, and electric shock.



Cleaning

Before cleaning the product, always unplug the AC adaptor from the wall outlet first. Leaving the AC adaptor plugged in creates the risk of damage to the AC adaptor, fire, and electric shock.







Safety Precautions

Batteries

Misuse of batteries can cause them to leak resulting in damage to nearby objects, or to explode, creating the risk of fire and personal injury. Always make sure you observe the following precautions.

- Use only batteries that are specified for use with this product. 
- Remove batteries from the product if you do not plan to use it for a long time.

Connectors

Connect only the specified devices and equipment to the product's connectors. Connection of a non-specified device or equipment creates the risk of fire and electric shock. 

Location

Avoid the following locations for this product. Such locations create the risk of fire and electric shock. 

- Areas subject to high humidity or large amounts of dust.
- In food preparation areas or other areas subject to oil smoke.
- Near air conditioning equipment, on a heated carpet, in areas exposed to direct sunlight, inside of a vehicle parked in the sun, or any other area that subjects the product to high temperatures.

Display Screen

- Never push on the display screen's LCD panel or subject it to strong impact. Doing so can cause the LCD panel's glass to crack, creating the risk of personal injury. 
- Should the LCD panel ever crack or break, never touch the liquid inside of the panel. LCD panel liquid can cause skin irritation.
- Should LCD panel liquid ever get inside your mouth, immediately wash out your mouth with water and contact your physician.
- Should LCD panel liquid ever get into your eyes or onto your skin, rinse with clear water for at least 15 minutes, and then contact a physician.

Sound Volume

Do not listen to music at very loud volumes for long periods. Particular care concerning this precaution is required when using headphones. High volume settings can damage your hearing. 

Heavy Objects

Never place heavy object on top of the product. 

Doing so can make the product top heavy, causing the product to tip over or the object to fall from it, creating the risk of personal injury.



Safety Precautions

IMPORTANT!

When using batteries, be sure to replace them or shift to one of the alternate power sources whenever you notice any of the following symptoms.

- Instrument does not turn on
 - Display that is flickering, dim, or difficult to read
 - Abnormally low speaker/headphone volume
 - Distortion of sound output
 - Occasional interruption of sound when playing at high volume
 - Sudden power failure when playing at high volume
 - Flickering or dimming of the display when playing at high volume
 - Continued sound output even after you release a key
 - A tone that is totally different from the one that is selected
 - Abnormal rhythm pattern and Song Bank play
 - Distortion of microphone input
 - Sudden power failure when using the microphone
-



Contents

Safety Precautions	E-1	Playing Song Bank Tunes	E-22
Contents	E-7	Selecting a Song Bank Tune	E-22
General Guide	E-8	Using Song Bank Tunes for Practice (3-Step Lesson)	E-23
About the Display	E-9	Using Step 1	E-23
Power Supply	E-10	Using Steps 2 and 3	E-24
Using batteries	E-10	Other Functions	E-25
Using the AC Adaptor	E-11	Turning on the Metronome	E-25
Connections	E-12	Using Sustain	E-25
Phones/Output Terminal	E-12	Percussion Pads	E-26
Accessories and Options	E-12	Transpose	E-26
Playing the Keyboard	E-13	Using MIDI	E-27
Playing the Demo Tunes	E-13	What is MIDI?	E-27
Using the Microphone ...	E-14	Using MIDI	E-27
Attaching the Microphone to the Keyboard	E-14	Troubleshooting	E-28
Unplugging the Microphone	E-16	Specifications	E-30
Using the Microphone for Singing	E-16	Care of your keyboard ...	E-31
Accessories and Options	E-16	Appendix	A-1
Selecting a Tone	E-17	Tone List	A-1
Selecting a Rhythm	E-18	Rhythm List	A-2
Using Auto Accompaniment	E-18	Song Bank List	A-3
Using Synchro Start	E-21	Fingered Chord Chart	A-4
Inserting a Rhythm Fill-in	E-21	MIDI Implementation Chart	
Using One-Touch Preset	E-21		
Adjusting Accompaniment Volume	E-21		



General Guide



- | | |
|---------------------------|------------------------------|
| ① POWER switch | ⑱ 3-STEP LESSON button |
| ② DEMO button | ⑲ RHYTHM button |
| ③ METRONOME button | ⑳ SONG BANK button |
| ④ MIDI button | ㉑ Speakers |
| ⑤ BEAT button | ㉒ Rhythm list |
| ⑥ MODE button | ㉓ Tone list |
| ⑦ SYNCHRO/FILL-IN buttons | ㉔ Display |
| ⑧ START/STOP button | ㉕ Song Bank list |
| ⑨ ONE TOUCH PRESET button | ㉖ Chord names |
| ⑩ SUSTAIN button | ㉗ Percussion instrument list |
| ⑪ TONE button | ㉘ MIC IN jack |
| ⑫ Number buttons | ㉙ MIDI OUT terminal |
| ⑬ Percussion pads | ㉚ PHONES/OUTPUT jack |
| ⑭ VOLUME buttons | ㉛ DC 9V jack |
| ⑮ ACCOMP VOLUME buttons | ㉜ Micropone |
| ⑯ TRANSPOSE buttons | ㉝ Micropone holder |
| ⑰ TEMPO buttons | ㉞ Micropone holder base |

NOTE

- The tone list, rhythm list, and Song Bank list do not show all of the tones, rhythms, and songs that are available. See the Appendix at the back of this manual for complete lists.
- Use only the microphone that comes with this keyboard. Never try to connect any other type of microphone.
- The microphone is intended for use exclusively with the MA-170 keyboard. Never try to use it with any other device.

About the Display

① NORMAL ▶

② CASIO CHORD ▶

③ FINGERED ▶

④ SUSTAIN

⑤ ONE TOUCH PRESET

⑥ STEP 1

⑦ STEP 2

⑧ STEP 3

278A-E-011A

E-9



Power Supply

This keyboard can be powered by current from a standard household wall outlet (using the specified AC adaptor) or by batteries. Always make sure you turn the keyboard off whenever you are not using it.

Using batteries

Always make sure you turn off the keyboard before loading or replacing batteries.

To load batteries

- 1 Remove the battery compartment cover.
- 2 Load 6 C-size batteries into the battery compartment.
 - Make sure that the positive (+) and negative (-) ends are facing correctly.

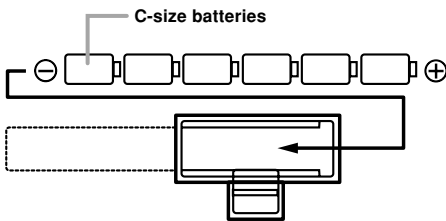

- 3 Insert the tabs on the battery compartment cover into the holes provided and close the cover.

The keyboard may not function correctly if you load or replace batteries with power turned on. If this happens, turning the keyboard off and then back on again should return functions back to normal.

Important Battery Information

- The following shows the approximate battery life.

Manganese batteries 5 hours*

* The above value is standard battery life at normal temperature, with the keyboard volume at medium setting. Temperature extremes or playing at very loud volume settings can shorten battery life.

- Any of the following symptoms indicate low battery power. Replace batteries as soon as possible whenever any of the following occurs.

- Instrument does not turn on
- Display that is flickering, dim, or difficult to read
- Abnormally low speaker/headphone volume
- Distortion of sound output
- Occasional interruption of sound when playing at high volume
- Sudden power failure when playing at high volume
- Flickering or dimming of the display when playing at high volume
- Continued sound output even after you release a key
- A tone that is totally different from the one that is selected
- Abnormal rhythm pattern and Song Bank play
- Distortion of microphone input
- Sudden power failure when using the microphone

⚠ WARNING

Misuse of batteries can cause them to leak, resulting in damage to nearby objects, or to explode, creating the risk of fire and personal injury. Always make sure you observe the following precautions.

- Never try to take batteries apart or allow them to become shorted. 
- Never expose batteries to heat or dispose of them by incineration.
- Never mix old batteries with new ones.
- Never mix batteries of different types.
- Do not charge the batteries.
- Make sure the positive (+) and negative (-) ends of the batteries are facing correctly.



Power Supply

⚠ CAUTION

Misuse of batteries can cause them to leak resulting in damage to nearby objects, or to explode, creating the risk of fire and personal injury. Always make sure you observe the following precautions.

- Use only batteries that are specified for use with this product. 
- Remove batteries from the product if you do not plan to use it for a long time.

Using the AC Adaptor

Make sure that you use only the AC adaptor specified for this keyboard.

Specified AC Adaptor: AD-5



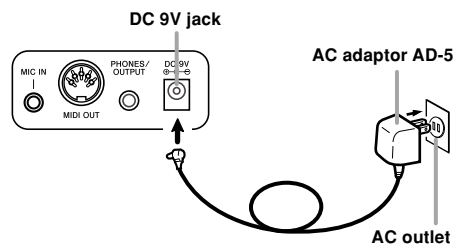

[Rear Panel]



Also note the following important warnings and precautions when using the AC adaptor.

⚠ WARNING



Misuse of the AC adaptor creates the risk of fire and electric shock. Always make sure you observe the following precautions.

- Be sure to use only the AC adaptor that is specified for this product.
- Use only a power source whose voltage is within the rating marked on the AC adaptor. 
- Do not overload electrical outlets and extension cords. 
- Never place heavy objects on the cord or subject it to heat. 
- Never try to modify the cord or subject it to excessive bending.
- Never twist or stretch the cord.
- Should the electric cord or plug become damaged, contact your original retailer or an authorized CASIO Service Provider. 

- Never touch the AC adaptor while your hands are wet. 
- Doing so creates the risk of electric shock.
- Use the AC adaptor where it will not be splashed with water. Water creates the risk of fire and electric shock.
- Do not place a vase or any other container filled with liquid on top of the AC adaptor. Water creates the risk of fire and electric shock.

⚠ CAUTION

Misuse of the AC adaptor creates the risk of fire and electric shock. Always make sure you observe the following precautions.

- Do not locate the electric cord near a stove or other sources of heat. 
- Never pull on the cord when unplugging from the electrical outlet. Always grasp the AC adaptor when unplugging.
- Insert the AC adaptor into the wall outlet as far as it will go. 
- Unplug the AC adaptor from the wall outlet during lightning storms or before leaving on a trip or other long-term absence.
- At least once a year, unplug the AC adaptor from the wall outlet and wipe away any dust that is built up in the area around the prongs of the plug.

IMPORTANT!

- Make sure that the keyboard is turned off before connecting or disconnecting the AC adaptor.
- Using the AC adaptor for a long time can cause it to become warm to touch. This is normal and does not indicate malfunction.



Connections

Phones/Output Terminal

Before connecting phones or other external equipment, be sure to first turn down the volume settings of the keyboard and the connected equipment. You can then adjust volume to the desired level after connections are complete.

[Rear Panel]

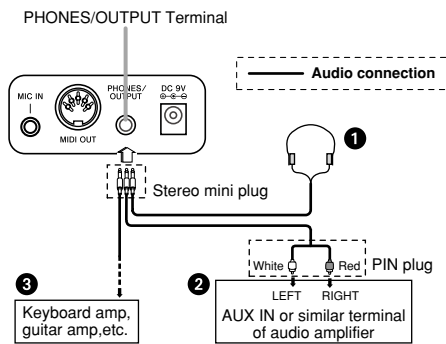

Connecting Phones (Figure 1)

Connecting phones cuts off output from the keyboard's built-in speakers, so you can play even late at night without disturbing anyone.

Audio Equipment (Figure 2)

Connect the keyboard to an audio equipment using a commercially available connecting cord with a mini plug on one end and two PIN plugs on the other end. Note that the mini plug you connect to the keyboard must be a stereo plug, otherwise you will be able to output only one of stereo channels. In this configuration, you normally set the input selector of the audio equipment to the terminal (usually marked AUX IN or something similar) where the cord from the keyboard is connected. See the user documentation that comes with your audio equipment for full details.

Musical Instrument Amplifier (Figure 3)

Use a commercially available connecting cord* to connect the keyboard to a musical instrument amplifier.

* Be sure to use a connecting cord that has a stereo mini plug on the end you connect to the keyboard, and a connector that provides dual channel (left and right) input to the amplifier to which you are connecting. The wrong type of connector at either end can cause one of the stereo channels to be lost.

When connecting to a musical instrument amplifier, set the volume of the keyboard to a relatively low level and make output volume adjustments using the amplifier's controls.

[Connection Example]

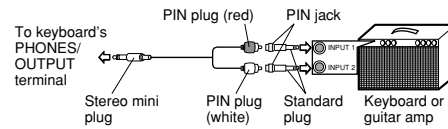

NOTE

- You can also connect the keyboard's MIDI terminal to a computer or sequencer. See "Using MIDI" on page E-27 for details.

Accessories and Options

Use only the accessories and options specified for this keyboard. Use of non-authorized items creates the danger of fire, electric shock, and personal injury.



Playing the Keyboard

- 1 Set the POWER switch to "ON" to turn on power.
- 2 Use the VOLUME buttons to adjust the volume level.
 - Press [▲] to raise the volume and [▼] to lower it.
 - The "MAIN" (main volume) value on the display indicates the current volume level.
 - You can set the main volume to one of 11 levels, from 0 to 10.
- 3 Now try playing something on the keyboard.

NOTE

Note Names

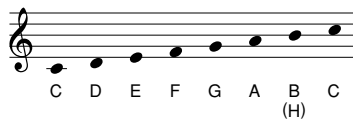

A value next to a note name indicates the relative position of the note on the keyboard as shown below.

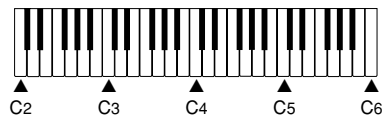

Playing the Demo Tunes

- 1 Press the DEMO button. This starts playback of the demo tunes in sequence, starting from the currently selected tune.
 - Press the DEMO button again to stop demo tune play.

NOTE

- The length and key of a built-in tune may be different from the original tune as it was written.





Using the Microphone

Attaching the Microphone to the Keyboard

Check to make sure that you have all the required items.



Microphone

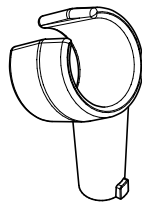

Microphone holder

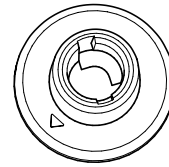

Microphone holder base

- 1 Wipe the console with a soft, dry cloth.
- 2 Peel the white paper from the base of the microphone holder.

Paper

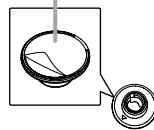

- 3 Affix the base so the Δ mark on the base and the Δ mark on the console are pointing at each other.

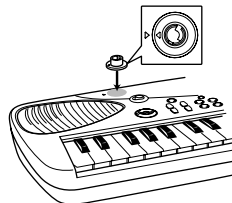

When affixing the base, make sure that you do not cover any of the lettering on the console. Do not touch the base for about 30 to 60 minutes after affixing it to the console. Doing so can cause the base to come off.

- 4 After waiting for about 30 to 60 minutes, align the tab of the holder with the microphone slot of the base, and insert the holder into the base.

Hole

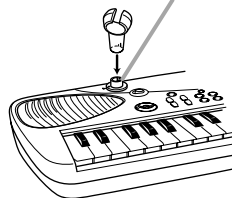



Using the Microphone

- 5 Rotate the holder in the direction indicated by the arrow to secure it in place.

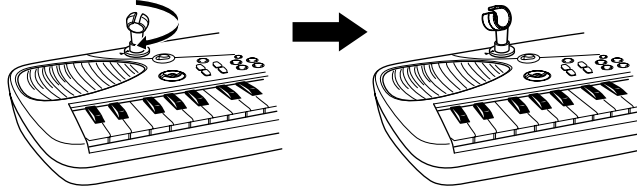

- 6 Check to make sure that the keyboard's POWER switch is set to "OFF".

- 7 Plug the microphone into the MIC IN jack.

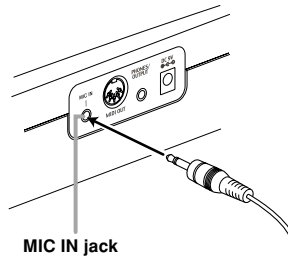

- 8 Slide the microphone onto the microphone holder as shown in the illustration.

To detach

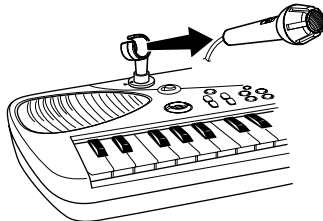

To attach



Make sure that the microphone is not pointed towards the speaker when it is mounted on the holder.

NOTE

- Use only the microphone that comes with this keyboard. Never try to connect any other type of microphone.
- The microphone is intended for use exclusively with the MA-170 keyboard. Never try to use it with any other device.



Using the Microphone

Unplugging the Microphone

Make sure you turn off the keyboard before unplugging the microphone. Grasp the plug and pull to unplug it. Never pull on the microphone cord. Doing so can damage the microphone and lead to malfunction.

Using the Microphone for Singing

- 1 After checking to make sure the microphone is turned off, turn on the keyboard.

Microphone switch



- 2 Next, turn on the microphone.
- 3 Use the microphone for singing along with demo tunes.
- 4 After you are finished using the microphone, turn it off.
- 5 Turn off the keyboard.

NOTE

- Before plugging in the microphone or unplugging it, make sure you first turn off the microphone and the keyboard.
- Always turn off the microphone whenever you are not using it.
- The length and key of a built-in tune may be different from the original tune as it was written.
- Microphone volume is fixed. You cannot adjust it.
- Use only the microphone that comes with this keyboard. Never try to connect any other type of microphone.
- The microphone is intended for use exclusively with the MA-170 keyboard. Never try to use it with any other device.

Howling (Feedback Noise)

Any of the following conditions can cause howling (feedback noise).

- Covering the head of the microphone with your hand
- Positioning the microphone too near to a speaker

Should howling occur, try grasping the microphone further away from the head, and move away from any nearby speaker.

Accessories and Options

Use only the accessories and options specified for this keyboard. Use of non-authorized items creates the danger of fire, electric shock, and personal injury.



Selecting a Tone

You can select from among 50 built-in tones. A tone list on the console shows the names and numbers of the tones.

- 1 Press the TONE button.
 - This causes "TONE" to appear on the display, along with the number of the currently selected tone.
- 2 Find the tone you want in the tone list, and then use the number buttons to input its two-digit number.
 - To select "06 MARIMBA", for example, press [0] then [6].
 - You can also use the + (higher) and - (lower) buttons to change the displayed tone number.
- 3 After selecting the tone, play something on the keyboard to hear what it sounds like.

NOTE

- The tone list, rhythm list, and Song Bank list do not show all of the tones, rhythms, and songs that are available. See the Appendix at the back of this manual for complete lists.
- The initial power on default tone setting is "00 GRAND PIANO".
- This keyboard has 8-note polyphony, which means it can play up to eight notes at the same time.
- When tone "49 PERCUSSION" is selected, keyboard keys are assigned the percussion sounds shown in the illustration below.

Keyboard Key	—	Name	Percussion Pad	Keyboard Key	—	Name	Percussion Pad
C3		BASS DRUM 1	○	D4		LOW TOM	
D3		BASS DRUM 2		E4		CLAVES	
E3		ACOUSTIC SNARE 1	○	F4		RIDE CYMBAL	
F3		ACOUSTIC SNARE 2		G4		HIGH CONGA	
G3		TAMBOURINE		A4		LOW CONGA	
A3		CLOSED HI-HAT	○	B4		HIGH AGOGO	
B3		OPEN HI-HAT	○	C5		LOW AGOGO	
C4		HIGH TOM	○	D5		MUTE TRIANGLE	



Selecting a Rhythm

You can select from among 30 rhythms. See the rhythm list at the end of this manual (page A-2) for information about what rhythms are available.

- 1 Press the RHYTHM button.
 - This causes "RHYTHM" to appear on the display, along with the number of the currently selected rhythm.
- 2 Find the rhythm you want in the "Rhythm List" on page A-2, and then use the number buttons to input its two-digit number.
 - To select "02 DANCE", for example, press [0] then [2].
 - You can also use the + (higher) and - (lower) buttons to change the displayed rhythm number.
- 3 Press the START/STOP button to start the currently selected rhythm.
- 4 Use the [▲] and [▼] TEMPO buttons to adjust the speed of the rhythm.
 - You can set the tempo value in the range of 40 to 240.
 - To return the tempo setting to the initial default value for the selected rhythm, press the [▲] and [▼] TEMPO buttons at the same time.
- 5 Press the START/STOP button again to stop rhythm play.

NOTE

- The tone list, rhythm list, and Song Bank list do not show all of the tones, rhythms, and songs that are available. See the Appendix at the back of this manual for complete lists.

Initial Default Tempo Settings

The following are the rules that govern the initial default tempo settings of built-in rhythms.

- Each rhythm has an initial default tempo setting that best matches the rhythm.
- Changing the selected rhythm while rhythm play is stopped automatically changes the tempo setting to initial default for the newly selected rhythm.
- Changing the selected rhythm while rhythm is playing changes the rhythm without changing the tempo setting. If One-Touch Preset is turned on (page E-21), the tempo setting is always changed with selection of a different rhythm, regardless of whether the rhythm is playing or not.

Using Auto Accompaniment

The 19 keys (C2 through F#3) on the far left of the keyboard are the "auto accompaniment keyboard". Pressing the keys of the auto accompaniment keyboard plays the chords marked above them.

PREPARATION

- Select the rhythm you want to use and adjust the tempo.

- 1 Use the MODE button to cycle through the available accompaniment options until the CASIO CHORD or FINGERED indicator is shown on the display.
 - Each press of the MODE button cycles through the accompaniment options in the sequence shown below.

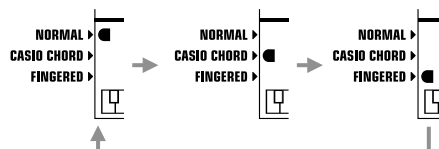

- 2 Press the START/STOP button to start the rhythm.



Selecting a Rhythm

- 3 Try playing a chord on the auto accompaniment keyboard.
 - The way you play chords depends on the auto accompaniment mode you select in step 1, above. For details, see “CASIO CHORD” and “FINGERED”, below.
- 4 To turn off auto accompaniment (so the auto accompaniment keyboard keys play normally), use the MODE button to select NORMAL.

CASIO CHORD

This method of chord play makes it possible for anyone to easily play chords, regardless of previous musical knowledge and experience. The following describes the CASIO CHORD “accompaniment keyboard” and “melody keyboard”, and tells you how to play CASIO CHORDs.

CASIO CHORD Accompaniment Keyboard and Melody Keyboard

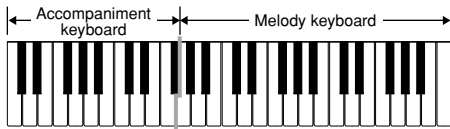

IMPORTANT!

- The accompaniment keyboard can be used for playing chords only. No sound will be produced if you try playing single melody notes on the accompaniment keyboard.

Chord Types

CASIO CHORD accompaniment lets you play four types of chords with minimal fingering.

Chord Types	Example
Major chords Chord names are marked above the keys of the accompaniment keyboard. Press any single key plays the chord whose name is marked above it. Note that the chord produced when you press an <code>accompaniment</code> keyboard does not change octave, regardless of which key you use to play it.	C Major (C)
Minor chords (m) To play a minor chord, keep the major chord key depressed and press any other accompaniment keyboard key located to the right of the major chord key.	C minor (Cm)
Seventh chords (7) To play a seventh chord, keep the major chord key depressed and press any other <code>accompaniment</code> keyboard keys located to the right of the major chord key.	C seventh (C7)
Minor seventh chords (m7) To play a minor seventh chord, keep the major chord key depressed and press any other three <code>accompaniment</code> keyboard keys located to the right of the major chord key.	C minor seventh (Cm7)



Selecting a Rhythm

NOTE

- It makes no difference whether you press black or white keys to the right of a major chord key when playing minor and seventh chords.

FINGERED

FINGERED provides you with a total of 12 different chord types. The following describes the FINGERED “accompaniment keyboard” and “melody keyboard”, and tells you how to play a C-root chord using FINGERED.

FINGERED Accompaniment Keyboard and Melody Keyboard



IMPORTANT!

- The accompaniment keyboard can be used for playing chords only. No sound will be produced if you try playing single melody notes on the accompaniment keyboard.

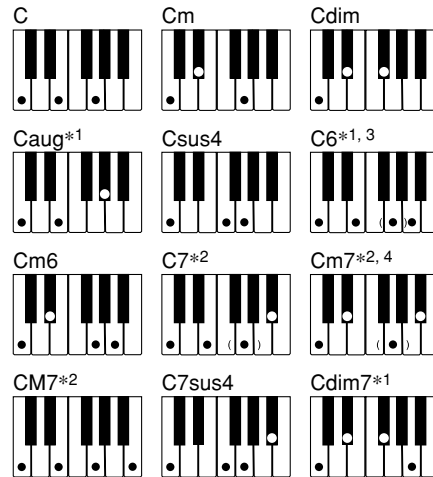

See the “Fingered Chord Chart” on page A-4 for details on playing chords with other roots.

- *1: Inverted fingerings cannot be used. The lowest note is the root.
- *2: The same chord can be played without pressing the 5th G.
- *3: The same chord can be played without pressing the 3rd E.
- *4: The first inversion is not supported, but the second and third inversions are available.

NOTE

- Except for the chords specified in note*1 above, inverted fingerings (i.e. playing E-G-C or G-C-E instead of C-E-G) will produce the same chords as the standard fingering.
- Except for the exception specified in note*2 and note*3 above, all of the keys that make up a chord must be pressed. Failure to press even a single key will not play the desired FINGERED chord.



Selecting a Rhythm



Using Synchro Start

When synchro start is turned on, rhythm play starts from the point when you play something on the keyboard.

PREPARATION

- Select a rhythm and set its tempo.
- Select the accompaniment mode you want to use.

- 1 Press the SYNCHRO/FILL-IN button.
 - This causes a black dot to appear on the display under the tempo indicator. The black dot indicates that synchro start is turned on.
- 2 Play a chord on the accompaniment keyboard.
 - The rhythm pattern starts to play automatically as soon as you play a chord.

NOTE

- If you set the mode to NORMAL, only the rhythm plays (without a chord) when you play on the keyboard.

Inserting a Rhythm Fill-in

A “fill-in” is a momentary change of the rhythm pattern.

- 1 While rhythm is playing, press the SYNCHRO/FILL-IN button.
 - This inserts the fill-in pattern, followed by a return to the normal rhythm pattern from the next measure.
 - To insert a long fill-in, keep the SYNCHRO/FILL-IN button depressed. The fill-in pattern will continue to be played as long as you keep the button depressed.

Using One-Touch Preset

The One-Touch Preset feature automatically makes the tone and tempo settings that are most suitable for the rhythm pattern you select.

- 1 Press the RHYTHM button.
- 2 Input the two-digit number of the rhythm you want to use.
- 3 Press the ONE TOUCH PRESET button.
 - This causes the ONE TOUCH PRESET indicator to appear on the display.
 - This keyboard automatically sets the tone and tempo in accordance with the rhythm you selected.
 - If you want to see the tone setting, press the TONE button.
- 4 Start the rhythm and play something on the keyboard.
 - Changing to a different rhythm while One-Touch Preset is turned on also causes the tone and tempo setting to change accordingly.
- 5 To turn off One-Touch Preset, press the ONE TOUCH PRESET button again so the ONE TOUCH PRESET indicator is not on the display.

Adjusting Accompaniment Volume

You can adjust the volume of the accompaniment independently of the notes you play on the keyboard.

- 1 Use the ACCOMP VOLUME buttons to adjust the accompaniment volume level.
 - Press [▲] to raise the volume and [▼] to lower it.
 - The “ACC.” (accompaniment volume) value on the display indicates the current accompaniment volume level.
 - You can set the accompaniment volume to one of 11 levels, from 0 to 10.



Playing Song Bank Tunes

A selection of 50 built-in Song Bank tunes is available for playback and practice. A Song Bank list on the console shows the names and numbers of the Song Bank tunes.

NOTE

- The tone list, rhythm list, and Song Bank list do not show all of the tones, rhythms, and songs that are available. See the Appendix at the back of this manual for complete lists.

Selecting a Song Bank Tune

- 1 Press the SONG BANK button.
 - This causes “SONG” to appear on the display, along with the number of the currently selected Song Bank tune.
- 2 Find the tune you want in the Song Bank list, and then use the number buttons to input its two-digit number.
 - You can also use the + (higher) and – (lower) buttons to change the displayed tune number.
- 3 Press the START/STOP button to start Song Bank tune play.
 - The image of a music staff appears in the center of the display, indicating the notes as they are played.
 - The graphic keyboard along the bottom of the display indicates the keyboard keys as they are played.
 - A black dot below the tempo indicator flashes in time with beat.
 - The name of the chord currently being played is shown in the upper left corner of the display.

- 4 You can use the TEMPO buttons to adjust the tempo of Song Bank tune play.

- 5 Press the START/STOP button again to stop Song Bank tune play.

NOTE

- The initial power on default Song Bank tune setting is “00 CANON (PACHELBEL)”.



Using Song Bank Tunes for Practice (3-Step Lesson)

3-Step Lesson makes it easy to master Song Bank tunes. You can learn to play melodies by viewing the guide indicators that appear on the display. In Step 1 you learn to master the timing of the notes, in Step 2 you play at your own pace, and finally in Step 3 you play along at normal speed.

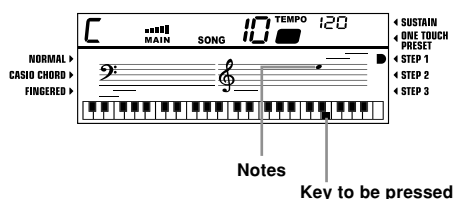

Step 1: In this step, you master the timing of the notes. Pressing any keyboard key plays the correct melody note, along with accompaniment.

Step 2: In this step, you learn correct keyboard keys you need to press. The on-screen graphic keyboard and staff display show the notes and the keys you need to press to play them. You can play at your own pace, even if it is very slow. Both the on-screen indicators and the accompaniment wait until you play the correct note.

Step 3: In this step, you play along at regular speed. The on-screen guide indicators and accompaniment change at normal speed, without waiting for you to play the correct note.

Using Step 1

- 1 Press the SONG BANK button, and then use the 3-STEP LESSON button to cycle through the 3-Step Lesson steps until the Step 1 indicator appears on the display.

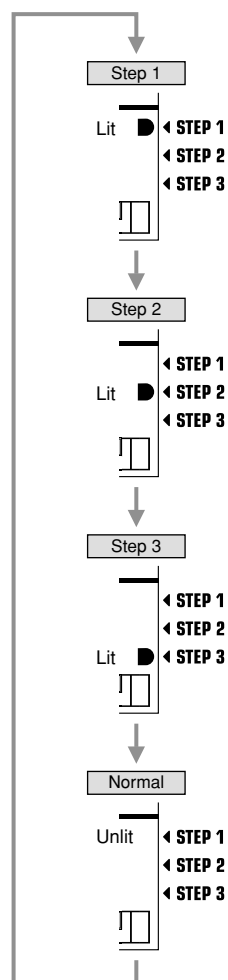



Using Song Bank Tunes for Practice (3-Step Lesson)

2 Find the Song Bank tune you want in the “Song Bank list” and then enter its two-digit tune number.

3 Press the START/STOP button.

- This starts playback of the Song Bank tune. When playback reached the point where the first melody note should be played, the key you should press is indicated on the on-screen keyboard, and the note you should play is indicated on the on-screen staff. At this time, playback pauses and accompaniment stands by, waiting for you to play the first note. Press the indicated key to start your practice session.
- Playback of the tune resumes as soon as you press the indicated keyboard key. When playback reaches the next melody note, accompaniment pauses again, and the on-screen keyboard and staff indicate the note you should play. Even if you make a mistake and press the wrong key, the keyboard plays the correct note.

4 To stop your practice session, press the START/STOP or the 3-STEP LESSON button.

- Pressing the 3-STEP LESSON button to stop the practice session also selects the next step (Step 2 in this example). At this point you could start a Step 2 practice session, if you want.

5 To turn off 3-Step Lesson, press the 3-STEP LESSON button to cycle through the steps until there is no indicator in the 3-Step Lesson indicator area.

Using Steps 2 and 3

In step 1 of the above procedure, use the 3-STEP LESSON button cycle through the steps until the Step 2 or Step 3 indicator is displayed.

- In Step 2, you learn correct keyboard keys you need to press. The on-screen music staff and graphic keyboard show you the notes to play and the keys to press. You can play at your own pace, even if it is very slow. Both the on-screen indicators and the accompaniment wait until you play the correct note. Unlike Step 1, accompaniment does not restart unless you press the correct keyboard key. Playback resumes when you press the correct key, and continues up the next melody note, where accompaniment pauses again, and the on-screen keyboard and staff indicate the note you should play.
- In Step 3, you play along at regular speed. The on-screen guide indicators and accompaniment change at normal speed, without waiting for you to play the correct note.



Other Functions

Turning on the Metronome

- 1 Press the TONE button or RHYTHM button, and then press the METRONOME button.
 - This causes the metronome to sound in accordance with the current tempo setting. A graphic metronome bar on the screen rocks left and right with each beat.
- 2 Use the [▲] and [▼] TEMPO buttons to adjust the tempo.
 - You can set the tempo value in the range of 40 to 240.
- 3 Press the METRONOME button again to turn off the metronome.

Specifying the Meter

- 1 While the metronome is sounding, press the BEAT button to cycle through the available meter settings.
 - You can select one of nine meter settings: 00 and 02 through 09.

Using Sustain

Turning on sustain causes notes you play to linger after you release the keyboard keys.

- 1 Press the SUSTAIN button.
 - Each press of the SUSTAIN button toggles sustain on and off. The SUSTAIN indicator on the display indicates that sustain is turned on.
- 2 Press the SUSTAIN button again to turn off sustain (indicated when there is no SUSTAIN indicator on the display).

NOTE

- The sustain effect differs according to the tone you are using. With some tones, you may not be able to hear much difference between sustain on and sustain off. Also note that sustain is not applied to percussion pad sounds and to percussion sounds produced when "49 PERCUSSION" is selected as the tone.



Other Functions

Percussion Pads

Using the Percussion Pads

Each of the five built-in percussion pads is assigned the sound of a percussion instrument (ACOUSTIC SNARE 1, OPEN HI-HAT, CLOSED HI-HAT, BASS DRUM 1, HIGH TOM). Tapping a pad with your finger plays the sound assigned to it.

Assigning Sounds to Percussion Pads

You can assign the percussion sound you want to each of the percussion pads.

NOTE

- Turning off power causes the sounds assigned to the percussion pads to return to their initial defaults.

- 1 While holding down the TONE button, use the number buttons to input 49, which selects the Percussion tone.
- 2 Look at the 16 white keys (C3 through D5) in the center of the keyboard that are marked with images of percussion instruments, and find the sound you want to assign to a pad.
- 3 While pressing down on the percussion pad to which you want to assign the sound, press the white key you selected in step 2.
- 4 Tap the percussion pad with your finger to hear the sound assigned to it.

Transpose

The initial power on default setting is middle C (00). You can transpose the key of the keyboard in semitone steps in the range of -6 to +6.

- 1 Press the TRANSPOSE [▲] button to raise the key one semitone, or the TRANSPOSE [▼] button to lower it one semitone.
 - To return the tuning to its initial power on default setting (00), press the TRANSPOSE [▲] and [▼] buttons at the same time.
 - Transpose is also returned to its initial power on default setting (00) whenever you turn on power.



Using MIDI

A MIDI OUT terminal on the back of the console lets you connect to other MIDI devices.

What is MIDI?

The letters "MIDI" stand for "Musical Instrument Digital Interface". MIDI is a world standard for digital signals and connectors that allows musical instruments, computers, and other devices, regardless of manufacturer, to exchange data with each other.

The keyboard's MIDI OUT terminal lets you connect to and send data to a MIDI sound source.

NOTE

- For details about the type of data you can send, see the MIDI Implementation Chart at the back of this manual.

Using MIDI

Connecting to a Computer

NOTE

- To perform the following procedure, you need a computer equipped with a MIDI interface. The computer must also have MIDI software installed on it.

- 1 Turn off the keyboard and your computer.
- 2 Use a MIDI cable to connect the keyboard to the computer's MIDI interface.
- 3 Turn on the keyboard and your computer.
 - Use the VOLUME buttons to set the main volume to a relatively low level.
 - Start up the MIDI software on your computer.

- 4 Select the keyboard's MIDI channel.
 - Each press of the MIDI button increments the MIDI channel setting. The current setting is shown on the display.
 - You can select a MIDI channel in the range of 01 through 16. The initial default setting is 01 (Channel 1).
- 5 Play something on the keyboard.
 - The applicable data for anything you play is sent to the connected computer.

NOTE

- Tone changes, and auto accompaniment, Song Bank tune, sustain, and transpose information are not sent as MIDI data.

Connecting to Another MIDI Device

It is up to you to provide the MIDI cable required to connect the keyboard to another MIDI device.

- If you connect the keyboard's MIDI OUT terminal to the MIDI IN terminal of another MIDI musical instrument, the connected instrument will sound what you play on the keyboard.



Troubleshooting

Problem	Possible Cause	Action	See
No sound when keyboard keys are pressed.	<ol style="list-style-type: none"> 1. Power supply problem. 2. Main volume is set to 0. 3. Headphones are plugged into the keyboard. 4. The accompaniment keyboard does not play notes while CASIO CHORD or FINGERED is selected as the accompaniment mode. 5. Some keys are not assigned any sounds while "49 PERCUSSION" is selected as the tone. 6. Playing the keyboard does not produce any sound during playback of a Song Bank tune or demo tune. 	<ol style="list-style-type: none"> 1. Correctly attach the AC adaptor, make sure that batteries poles (+/-) are facing correctly, and check to make sure that batteries are not dead. 2. Press the VOLUME [▲] button. 3. Unplug the headphones from the PHONES/OUTPUT jack. 4. Change to the NORMAL accompaniment mode. 5. Only keyboard keys in the range of C3 through D5 (the ones marked with percussion instrument illustrations) produce sounds while "49 PERCUSSION" is selected as the tone. 6. Stop Song Bank tune or demo tune playback. 	<p>Pages E-10, 11</p> <p>Page E-13</p> <p>Page E-12</p> <p>Page E-18</p> <p>Page E-17</p> <p>Pages E-13, 22</p>
No sound from the microphone.	<ol style="list-style-type: none"> 1. Microphone is not plugged into the keyboard correctly. 2. Microphone is turned off. 	<ol style="list-style-type: none"> 1. Correctly plug the microphone into the keyboard. 2. Turn on the microphone. 	<p>Pages E-14, 15</p> <p>Page E-16</p>



Troubleshooting



Problem	Possible Cause	Action	See
Any of the following symptoms while using battery power. <ul style="list-style-type: none"> Instrument does not turn on Display that is flickering, dim, or difficult to read Abnormally low speaker/headphone volume Distortion of sound output Occasional interruption of sound when playing at high volume Sudden power failure when playing at high volume Flickering or dimming of the display when playing at high volume Continued sound output even after you release a key A tone that is totally different from the one that is selected Abnormal rhythm pattern and Song Bank play Distortion of microphone input Sudden power failure when using the microphone 	Low battery power	Replace the batteries with a set of new ones or use the AC adaptor.	Pages E-10, 11
Auto Accompaniment does not sound.	Auto accompaniment volume is set to 0.	Use the ACCOMP VOLUME button to increase the volume.	Page E-21
The TRANSPOSE function does not work. MODE button does not work.	1. "49 PERCUSSION" is selected as the tone. 2. The instrument is in the Song Bank Mode. 3. A demo tune is playing.	1. Select any other tone besides "49 PERCUSSION". 2. Press the TONE or RHYTHM button to exit the Song Bank Mode. 3. Stop demo tune play and press the TONE or RHYTHM button to exit the Song Bank Mode.	Page E-17 Pages E-17, 18 Pages E-17, 18
SYNCHRO/FILL-IN button does not work. ONE TOUCH PRESET button does not work. SUSTAIN button does not work.	1. The instrument is in the Song Bank Mode. 2. A demo tune is playing.	1. Press the TONE or RHYTHM button to exit the Song Bank Mode. 2. Stop demo tune play and press the TONE or RHYTHM button to exit the Song Bank Mode.	Pages E-17, 18 Pages E-17, 18
3-STEP LESSON button does not work.	The instrument is not in the Song Bank Mode.	Press the SONG BANK button to enter the Song Bank Mode.	Page E-22



Specifications

Model:	MA-170
Number of Keys:	49 (mini-size)
Maximum Polyphony:	8 notes
Number of Tones:	50
Auto Accompaniment Rhythm Patterns: Tempo: Chords: Rhythm Controller: Accomp Volume:	30 Variable (201 steps, ♩ = 40 to 240) 2 fingering methods (CASIO CHORD, FINGERED) SYNCHRO/FILL-IN, START/STOP 0 to 10 (11 steps)
Number of Song Bank Tunes:	50
Percussion Pads:	5
Main Volume:	0 to 10 (11 steps)
Other Functions:	3-Step Lesson; One-Touch Preset; Metronome; Transpose; Sustain; Demo tunes play
MIDI:	MIDI channel setting (01 through 16)
Speakers:	8 cm diameter × 2 (Output: 3W + 3W)
Power Requirements: Batteries: Battery life: AC adaptor:	2-way C-size batteries × 6 Approximately 5 hours on manganese batteries AD-5
Input/Output MIDI Terminal: Power Supply terminal: Headphone/Output Terminal: Microphone In:	OUT 9V DC Stereo mini jack Output Impedance: 30Ω Output Voltage: 6.0V (RMS) MAX Mini jack Input Impedance: 9kΩ
Power Consumption:	9V ⎓ 7.7W
Dimensions:	66.7 × 25.0 × 7.6 cm (26 ¹ / ₄ × 9 ⁷ / ₈ × 3 inch)
Weight:	Approximately 2.1 kg (4.6 lbs)(without batteries)

* Specifications and design are subject to change without notice.



Care of your keyboard

Avoid heat, humidity or direct sunlight.

Do not overexpose the instrument to direct sunlight, or place it near an air conditioner, or in any extremely hot place.

Do not use near a TV or radio.

This instrument can cause video or audio interference with TV and radio reception. If this happens, move the instrument away from the TV or radio.

Do not use lacquer, thinner or similar chemicals for cleaning.

Clean the keyboard with a soft cloth dampened in a weak solution of water and a neutral detergent. Soak the cloth in the solution and squeeze until it is almost dry.

Avoid use in areas subjected to temperature extremes.

Extreme heat can cause figures on the LCD screen to become dim and difficult to read. This condition should correct itself when the keyboard is brought back to normal temperature.

NOTE

- You may notice lines in the finish of the case of this keyboard. These lines are a result of the molding process used to shape the plastic of the case. They are not cracks or breaks in the plastic, and are no cause for concern.
-



Appendix/ Apéndice/ Appendice

Tone List/Lista de sonidos/Liste des sonorités

PIANO	
00	GRAND PIANO
01	ELEC PIANO 1
02	ELEC PIANO 2
03	HARPSICHORD 1
04	HARPSICHORD 2
05	VIBRAPHONE
06	MARIMBA
ORGAN	
07	ELEC ORGAN 1
08	ELEC ORGAN 2
09	ELEC ORGAN 3
10	ELEC ORGAN 4
11	CHURCH ORGAN
12	REED ORGAN
13	ACCORDION
14	HARMONICA
GUITAR/BASS	
15	NYLON STR GT
16	STEEL STR GT
17	CLEAN GUITAR
18	DIST GUITAR
19	ELEC GUITAR 1
20	ELEC GUITAR 2
21	ACOUSTIC BASS
22	FINGERED BASS
23	SLAP BASS
24	ELEC BASS
STRINGS/ENSEMBLE	
25	VIOLIN
26	PIZZICATO STR
27	HARP
28	STRINGS 1
29	STRINGS 2

BRASS	
30	TRUMPET
31	TROMBONE
32	TUBA
33	FRENCH HORN
34	BRASS 1
35	BRASS 2
REED/PIPE	
36	SAX 1
37	SAX 2
38	BASSOON
39	CLARINET
40	PICCOLO
41	FLUTE
VARIOUS	
42	BANJO
43	SYNTH-LEAD 1
44	SYNTH-LEAD 2
45	SYNTH-PAD 1
46	SYNTH-PAD 2
47	SYNTH-SFX 1
48	SYNTH-SFX 2
49	PERCUSSION



Appendix/Apéndice/Appendice

Rhythm List/Lista de ritmos/Liste des rythmes

DANCE/POPS	
00	DISCO 1
01	DISCO 2
02	DANCE
03	POP BALLAD
04	POP WALTZ
05	FUSION
06	FUNK
07	16 BEAT
08	SOUL
ROCK/JAZZ	
09	ROCK 1
10	ROCK 2
11	8 BEAT
12	R&B
13	BLUES
14	SLOW ROCK
15	SHUFFLE ROCK
16	SHUFFLE BOOGIE
17	ROCK 3
18	SWING
19	JAZZ WALTZ
20	BIG BAND
LATIN/VARIOUS	
21	CHA-CHA-CHA
22	BOSSA NOVA 1
23	BOSSA NOVA 2
24	RHUMBA
25	BEGUINE
26	TANGO
27	COUNTRY
28	WALTZ
29	MARCH



Appendix/Apéndice/Appendice

**Song Bank List/Lista del banco de canciones/
Liste des morceaux préenregistrés**

00	CANON (PACHELBEL)
01	CARRY ME BACK TO OLD VIRGINIA
02	JAMAICA FAREWELL
03	MARCH FROM "THE NUTCRACKER"
04	MICHAEL ROW THE BOAT ASHORE
05	WIEGENLIED (SCHUBERT)
06	SIPPIN' CIDER THROUGH A STRAW
07	MINUET (J.S.BACH)
08	WALTZ OF THE FLOWERS FROM "THE NUTCRACKER"
09	THE STAGECOACH
10	OH! SUSANNA
11	MY BONNIE
12	MY OLD KENTUCKY HOME
13	BELIEVE ME IF ALL THOSE ENDEARING YOUNG CHARMS
14	TURKEY IN THE STRAW
15	I'VE BEEN WORKING ON THE RAILROAD
16	PIZZICATO POLKA
17	THE ENTERTAINER
18	JINGLE BELLS
19	DANNY BOY
20	JEANNIE WITH THE LIGHT BROWN HAIR
21	SHE WORE A YELLOW RIBBON
22	THE OLD GRAY MARE
23	SCENE FROM "SWAN LAKE"
24	HEIDENRÖSLEIN (SCHUBERT)
25	MINUET (J.KRIEGER)

26	AMERICAN PATROL
27	LONG LONG AGO
28	SANTA LUCIA
29	FRÖHLICHER LANDMANN
30	LA CUCARACHA
31	AVE MARIA (GOUNOD)
32	GREENSLEEVES
33	ALOHA OE
34	TWINKLE TWINKLE LITTLE STAR
35	FRÜHLINGSLIED (MENDELSSOHN)
36	WHEN THE SAINTS GO MARCHING IN
37	LITTLE BROWN JUG
38	CUCKOO WALTZ
39	GRANDFATHER'S CLOCK
40	JOY TO THE WORLD
41	DECK THE HALLS
42	DONAUWELLEN WALZER
43	CIELITO LINDO
44	AMAZING GRACE
45	O CHRISTMAS TREE
46	HOME ON THE RANGE
47	IF YOU'RE HAPPY AND YOU KNOW IT, CLAP YOUR HANDS
48	TROIKA
49	LONDON BRIDGE



Appendix/Apéndice/Appendice

Fingered Chord Chart/Cuadro de acordes Fingered/
Charte des accords FINGERED

Root \ Chord Type	M	m	7	m7	M7	dim
C						
C#/(Db)						
D						
(D#)/Eb						
E						
F						
F#/(Gb)						
G						
(G#)/Ab						
A						
(A#)/Bb						
B						



Appendix/Apéndice/Appendice

Root \ Chord Type	aug	sus4	7sus4	6	m6	dim7
C						
C#/(Db)						
D						
(D#)/Eb						
E						
F						
F#/(Gb)						
G						
(G#)/Ab						
A						
(A#)/Bb						
B						

NOTE

- You can use the above fingerings to finger chords within the accompaniment keyboard range.

NOTA

- Para digitar los acordes dentro de la gama del teclado de acompañamiento puede usar las digitaciones anteriores.

REMARQUE

- Vous pouvez utiliser les doigtés ci-dessus pour jouer des accords dans la plage du clavier d'accompagnement.

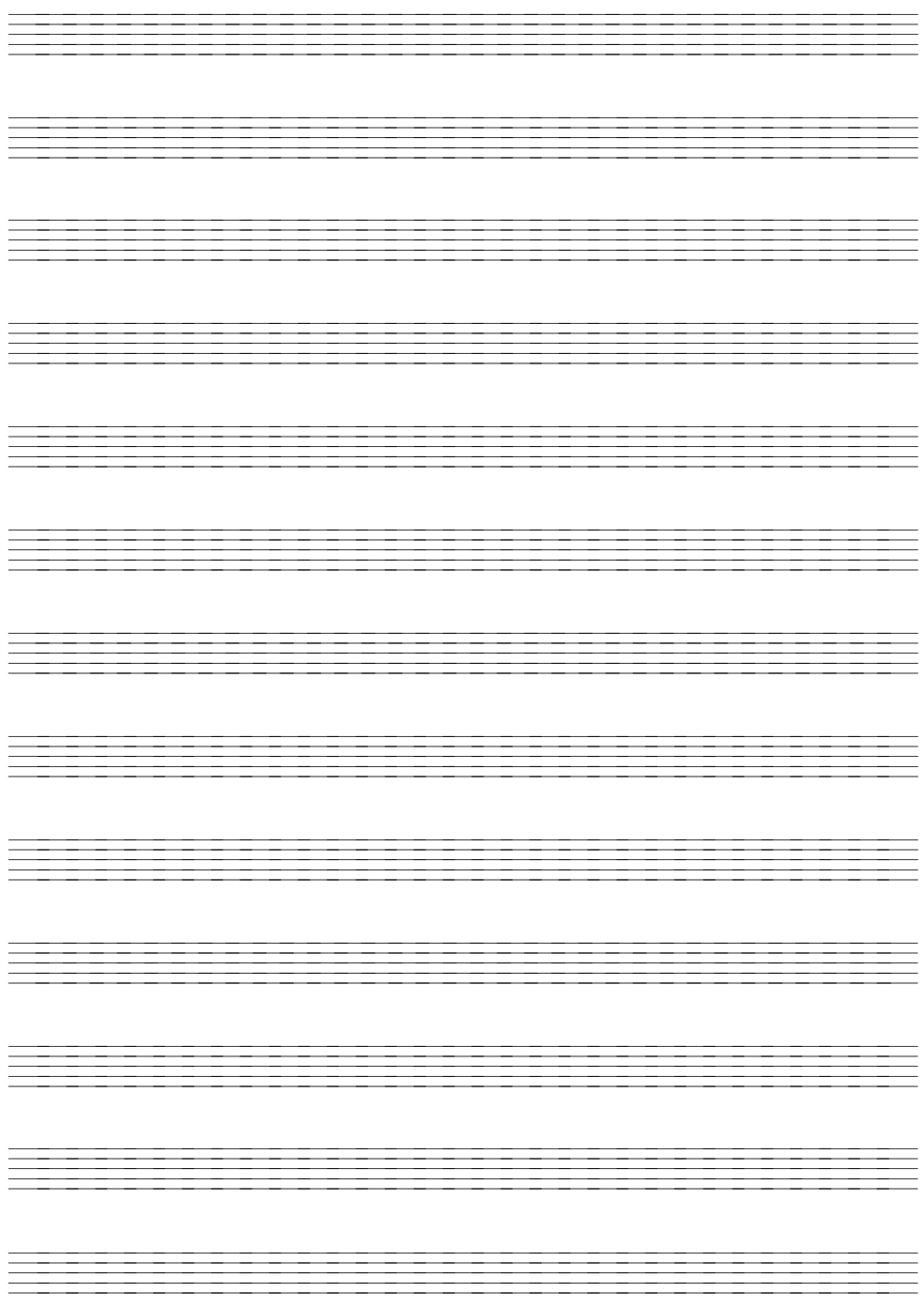

278A-E-104A



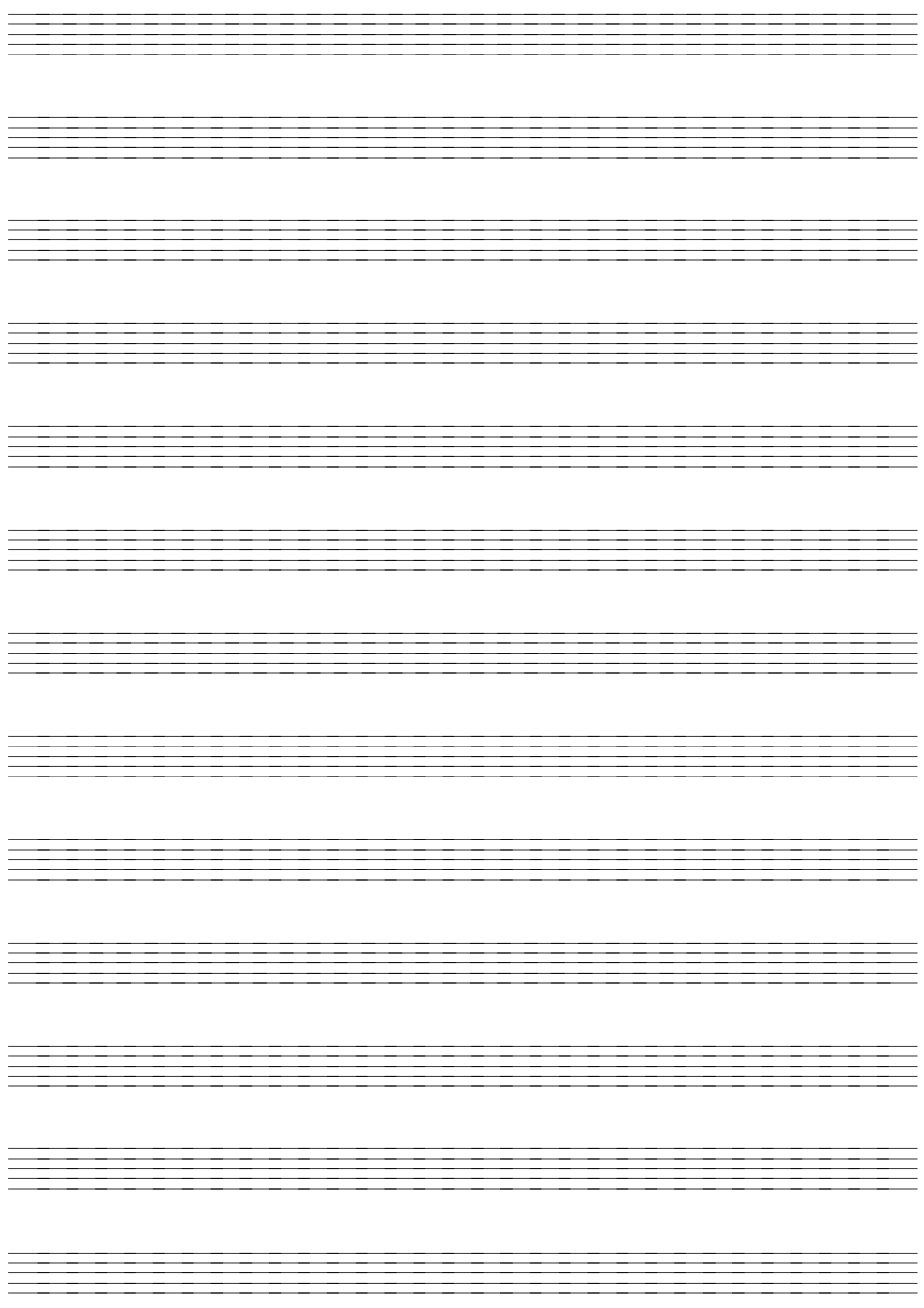

278A-E-105A



Model **MA-170** **MIDI Implementation Chart** Version: 1.0

Function ...	Transmitted	Recognized	Remarks
Basic Channel			
Default Changed	1 1 - 16	X *****	
Mode			
Default Messages Altered	Mode 3 X *****	X X *****	
Note Number:			
True voice	36 - 84 *****	X *****	
Velocity			
Note ON	O 9nH v = 64	X	
Note OFF	X 9nH v = 0	X	
After Touch			
Key's Ch's	X X	X X	
Pitch Bender			
	X	X	
Control Change			
1	X	X	Modulation
6,38	X	X	Data entry
7	X	X	Volume
10	X	X	Pan
11	X	X	Expression
64	X	X	Hold1
66	X	X	Sostenuto
67	X	X	Soft Pedal
100,101	X	X	RPN LSB, MSB
120	X	X	All sound off



Control Change	1 6,38 7 10 11	X X X X X	X X X X X	Modulation Data entry Volume Pan Expression
	64 66 67 100,101 120 121	X X X X X X	X X X X X X	Hold1 Sostenuto Soft Pedal RPN LSB, MSB All sound off Reset all controller
Program Change:	True #	X *****	X *****	
System Exclusive		X	X	
System Common	: Song Pos : Song Sel : Tune	X X X	X X X	
System Real Time	: Clock : Commands	X X	X X	
Aux Messages	: Local ON/OFF : All notes OFF : Active Sense : Reset	X O X X	X X X X	
Remarks				

O : Yes
X : No

Mode 2 : OMNI ON, MONO
Mode 4 : OMNI OFF, MONO

Mode 1 : OMNI ON, POLY
Mode 3 : OMNI OFF, POLY



This recycle mark indicates that the packaging conforms to the environmental protection legislation in Germany.

Esta marca de reciclaje indica que el empaquetado se ajusta a la legislación de protección ambiental en Alemania.

Ce sigle signifie que l'emballage est conforme à la législation allemande en matière de protection de l'environnement.

CASIO®

CASIO COMPUTER CO.,LTD.
6-2, Hon-machi 1-chome
Shibuya-ku, Tokyo 151-8543, Japan

MA0307-A Printed in China
Imprimé en Chine
MA170-ESF-1