

User's Guide (Basic Operations)

- Be sure to read the "Safety Precautions" on page E-2 and "Operating Precautions" on page E-6 before trying to use this projector.
- This manual covers only basic operations, including how to set up the projector, basic projector operations, and how to replace the lamp. For more detailed information, see the User's Guide (UsersGuide_English.pdf) on the CD-ROM that comes with the projector.

Contents

Safety Precautions	E-2	Connecting a Computer to the Projector	E-17
Operating Precautions	E-6	Connecting to a Standard Video Device ...	E-17
Unpacking	E-9	Turning On the Projector	E-18
Using the User Documentation on the CD-ROM	E-9	Turning Off the Projector	E-20
Projector Features and Main Functions	E-10	Projection Operations	E-22
General Guide	E-10	Projecting onto a Screen	E-22
Remote Controller General Guide	E-12	Keystone Correction (AF/AK, KEYSTONE)	E-23
Loading Remote Controller Batteries	E-13	Using the Setup Menu	E-25
Using the Laser Pointer	E-13	User Maintenance	E-26
Getting Ready	E-14	Cleaning the Projector	E-26
Setting Up the Projector	E-14	Reattaching the Lens Cover	E-26
Setup Precautions	E-15	Replacing the Lamp	E-26
Adjusting the Projector		Troubleshooting	E-30
Elevation Angle	E-16	Indicators and Alert Tones	E-30
Rear Projection (From the Back of the Screen)	E-16	Projector Troubleshooting	E-31
		Specifications	E-32

- Digital Light Processing™, DLP™, Digital Micromirror Device™, and DMD™ are trademarks of Texas Instruments Incorporated of the United States.
- Microsoft, Windows, Windows NT, Windows XP, and the Windows logo are registered trademarks or trademarks of Microsoft Corporation of the United States in the United States and other countries.
- Apple and Macintosh are registered trademarks of Apple Computer, Inc. of the United States.
- Adobe and Acrobat are registered trademarks of Adobe Systems Incorporated.
- Other company and product names may be registered trademarks or trademarks of their respective owners.



- The contents of this User's Guide are subject to change without notice.
- Copying of this manual, either in part or its entirety, is forbidden. You are allowed to use this manual for your own personal use. Any other use is forbidden without the permission of CASIO COMPUTER CO., LTD.
- CASIO COMPUTER CO., LTD. shall not be held liable for any lost profits or claims from third parties arising out of the use of this product or this manual.
- CASIO COMPUTER CO., LTD. shall not be held liable for any loss or lost profits due to loss of data caused by malfunction or maintenance of this product, or any other reason.
- The sample screens shown in this manual are for illustrative purposes only, and appear differently from the screens actually produced by the product.

Safety Precautions

Thank you for selecting this CASIO product. Be sure to read these "Safety Precautions" before trying to use it. After reading this User's Guide, keep it in a safe place for future reference.

About safety symbols

Various symbols are used in this User's Guide and on the product itself to ensure safe use, and to protect you and others against the risk of injury and against material damage. The meaning of each of the symbols is explained below.

 Danger	This symbol indicates a condition that, if ignored or applied incorrectly, creates the risk of death or serious personal injury.
 Warning	This symbol indicates a condition that, if ignored or applied incorrectly, could possibly create the risk of death or serious personal injury.
 Caution	This symbol indicates a condition that, if ignored or applied incorrectly, could possibly create the risk of personal injury or material damage.

Icon Examples



A triangle indicates a situation against which you need to exercise caution. The example shown here indicates you should take precaution against electric shock.



A circle with a line through it indicates information about an action that you should not perform. The specific action is indicated by the figure inside the circle. The example shown here means disassembly is prohibited.



A black circle indicates information about an action that you must perform. The specific action is indicated by the figure inside the circle. The example shown here indicates you must unplug the power cord from the power outlet.

Precautions During Use



Warning

● Smoke, odor, heat, loud noise, and other abnormalities



Should you ever notice smoke, strange odor, or loud noise being emitted by the projector, or any other abnormality, immediately stop using the projector.

Continued use creates the risk of fire and electric shock. Immediately perform the following steps.

1. Unplug the projector.
2. Contact your original dealer or authorized CASIO service center.

● Malfunction



Immediately stop using the projector if the screen appears abnormal, if sound is not produced, or if any other abnormal operation occurs even though you are operating the projector correctly. Continued use creates the risk of fire and electric shock. Immediately perform the following steps.

1. Turn off the projector.
2. Unplug the projector.
3. Contact your original dealer or authorized CASIO service center.

● Power cord



Misuse of the power cord creates the risk of fire and electric shock. Make sure that you always observe the following precautions.

- Make sure that you use a power source with the same voltage as that specified for the projector.
- Do not overload a power outlet with too many devices.

● Power cord



A damaged power cord creates the risk of fire and electric shock. Make sure that you always observe the following precautions.

- Never place heavy objects on the power cord and never expose it to heat.
- Make sure the power cord is not pinched between the wall and the rack or table where the projector is located, and never cover the power cord with a cushion or other object.
- Never try to modify the power cord, allow it to become damaged, or subject it to excessive bending.
- Do not twist the power cord or pull on it.

● **Power cord**



Never touch the power cord or plug while your hands are wet. Doing so creates the risk of electric shock.

- When using this projector in the country where you purchased it, be sure to use the power cord that came with it. Whenever using the projector in another country, be sure to purchase and use a power cord that is rated for the voltage of that country.

● **Water and foreign matter**



Never allow water to get on the projector. Water creates the risk of fire and electric shock.



Never place a vase or any other container of water on top of the projector. Water creates the risk of fire and electric shock.



Water or other liquid, or foreign matter (metal, etc.) getting into the projector creates the risk of fire and electric shock. Should anything get inside the projector, immediately perform the following steps.

1. Turn off the projector.
2. Unplug the projector.
3. Contact your original dealer or authorized CASIO service center.

● **Disassembly and modification**



Never try to take the projector apart or modify it in any way. The projector contains a large number of high-voltage components that create the risk of electric shock and burn injury.

Be sure to leave all internal inspection, adjustment, and repair up to your original dealer or authorized CASIO service center.

● **Dropping and impact**



Continued use of the projector after it has been damaged by dropping or other mistreatment creates the risk of fire and electric shock. Immediately perform the following steps.

1. Turn off the projector.
2. Unplug the projector.
3. Contact your original dealer or authorized CASIO service center.

● **Disposal by burning**



Never try to dispose of the projector by burning it. Doing so can cause an explosion, which creates the risk of fire and personal injury.

● **Looking into the lens or vents while lamp is on**



Never look directly into the lens or vents while lamp is on. The strong light emitted by the projector creates the risk of eye damage.

● **Blocking the vents**



Never allow the intake vents (on the bottom or back of the projector) or the exhaust vents (on the front or side of the projector) to become blocked. Doing so causes internal heat build up, which creates the risk of fire and breakdown of the projector. Touching the projector while it is hot creates the risk of burn injury. Make sure that you always observe the following precautions.

- Allow at least 30cm (11.8 inches) between the projector and walls.
- Do not insert the projector into any space where air circulation is poor.
- Never cover the projector with a blanket or any similar item.
- Locate the projector on a firm, flat surface during use. Never use the projector while it is on a carpet, blanket, towel, seat cushion, or other pliable surface.
- Never stand the projector up on either end during use.

● **Projector cabinet**



Never open the projector's cabinet. Doing so creates the risk of electric shock.

● **Cleaning**



Before cleaning the projector, be sure to turn it off and unplug it from the power outlet. Failure to do so creates the risk of electric shock.

● **Exhaust vents**

The exhaust vents become very hot while the projector is running. Never touch them. Doing so creates the risk of burn injury. The areas near the exhaust vents also become quite hot. Never locate objects made of plastic or other heat-sensitive materials near or under the projector. Doing so creates the risk of deformation and discoloration of the object.

● **Lens cover**

Be sure to open the lens cover before turning on the projector. Never close the lens cover while the projector is in use.

Safety Precautions

● Location

Never locate the projector in any of the following types of locations. Doing so creates the risk of fire and electric shock.

- Near an area subject to strong vibration
- An area subject to large amounts of moisture or dust
- In a kitchen or other area exposed to oil smoke
- Near a heater, on a heated carpet, or in an area exposed to direct sunlight
- An area subject to temperature extremes (Operating temperature range is 5°C to 35°C (41 to 95°F)).

● Heavy objects

Never place heavy objects on the projector or climb on top of the projector. Doing so creates the risk of fire and electric shock.

● Water

Never locate the projector in a bathroom or anywhere else there is the chance that it will be splashed with water.

● Unstable location



Never place the projector on an unstable surface or on a high shelf. Doing so can cause it to fall, creating the risk of personal injury.

● Using the projector on a base with casters

Whenever using the projector on a base that has casters, make sure that you lock the casters when not moving the base.

● Lightening

During a lightening storm, do not touch the plug of the projector's power cord.

● Remote controller



Never try to take the remote controller apart or modify it in any way. Doing so creates the risk of electric shock, burn injury, and other personal injury. Be sure to leave all internal inspection, adjustment, and repair up to your original dealer or authorized CASIO Service Center.



Never allow the remote controller to become wet. Water creates the risk of fire and electric shock.



Caution

● Power cord



Misuse of the power cord creates the risk of fire and electric shock. Make sure that you always observe the following precautions.

- Do not locate the power cord near a stove.
- When unplugging the power cord, always grasp the plug, and do not pull on the power cord.
- Insert the plug into the power outlet as far as it will go.
- After using the projector, turn it off and unplug it from the power outlet.
- Unplug the projector from the power outlet if you do not plan to use it for a long time.
- To avoid the built up of dust between the prongs of the plug, unplug it from the power outlet and clean between the prongs at least once a year.
- Before moving the projector, be sure to turn it off and unplug it from the power outlet first.

● Backup of important data



Be sure to keep separate written records of all data stored in projector memory. Memory data can be lost due to breakdown, maintenance, etc.

● Lens effect

Never have an aquarium or any other object that produces a lens effect in front of the projector while the lamp is on. Such an object creates the risk of fire.

● Lens

Never touch the lens with your hand.

Battery Precautions

Warning

Misuse of batteries can cause them to leak and stain the area around them, or to explode, creating the risk of fire and personal injury. Make sure that you always observe the following precautions.



- Never try to take batteries apart and do not allow them to become shorted.
- Never expose batteries to heat or throw them into fire.
- Never mix old batteries and new ones.
- Never mix batteries of different types.
- Never try to charge batteries.
- Take care that batteries are oriented correctly when you load them.



Caution

Misuse of batteries can cause them to leak and stain the area around them, or to explode, creating the risk of fire and personal injury. Make sure that you always observe the following precaution.



- Use only the type of batteries that is specified for the remote controller.

● Dead batteries

Be sure to remove batteries from the remote controller as soon as they go dead.



- Remove batteries from the remote controller if you do not plan to use it for a long time.

● Disposing of batteries

Make sure that you dispose of used batteries in accordance with the rules and regulations in your local area.

Lamp Precautions

Warning

● Lamp removal



Never remove the lamp from the projector immediately after using it. The lamp becomes very hot during use, creating the risk of burn injury. Turn off the projector. After the POWER/STANDBY indicator changes to steady (not flashing) amber, unplug the projector from the power outlet. Next, wait for at least 60 minutes before removing the lamp.

● Specified lamp type



Use only the lamp type that is specified for this projector. Use of any other type of lamp creates the risk of fire and breakdown.

Caution

● Lamp replacement



Before replacing the lamp, be sure to turn off the projector and unplug it from the power outlet. Failure to do so creates the risk of electric shock.

- Take care when replacing a broken lamp. A broken lamp can cause glass fragments to be scattered inside the lamp housing. Glass inside of the lamp housing may also be discharged from the projector's vent exhaust ports. Gas inside of the lamp includes mercury, so be sure to ventilate the area whenever the lamp breaks. Should you accidentally inhale gas fumes or should gas fumes get into your eyes, immediately contact a physician.

● Broken lamp



Never attempt to replace a broken lamp on your own. The projector uses a mercury lamp with high internal pressure as its light source. Should the lamp break, be sure to contact your original dealer or authorized CASIO service center to request replacement. Attempting to replace a broken lamp on your own creates the risk of personal injury due to broken glass or dispersed mercury.

Other

Caution

Allowing dust to build up inside the projector for long periods without cleaning creates the risk of fire and breakdown. Contact your original dealer or authorized CASIO service center once a year about having the interior of the projector cleaned. Note that you will be charged for cleaning.

Operating Precautions

Lamp Handling Precautions



Caution

Continued use of a lamp that has passed its lamp life increases the risk of the lamp rupturing. Replace the lamp with a new one as soon as possible after the replacement message appears.

- Never touch the glass of the lamp with your fingers. Doing so can damage the lamp and shorten its life.
- The light source lamp is a consumable item. The average life of a lamp is approximately 2000 hours. After 2000 hours, a message appears to alert you to the need of lamp replacement. However, note that the characteristics of a particular lamp or lamp operating conditions can cause the lamp to start to go dim or even fail before the message appears.
- Lamps are guaranteed for 90 days from the date of purchase or for 500 hours operation, whichever comes first.
- A mercury lamp with high internal pressure is used as the light source. A lamp that is weakened by impact, damage, or expiration of its lamp life may explode or fail to light if exposed to loud noise. Note that the performance of the lamp differs greatly from lamp to lamp, and due to conditions under which a lamp is used.
- The replacement message appears and the LAMP indicator flashes red after the lamp life is reached. When this happens, replace the lamp using the instructions provided in this User's Guide.
- If the lamp continues to be used after its lamp life is reached, after 100 hours the projector will enter a cool down state and then go into standby. The projector will not turn on again until you replace the lamp.

Lamp Replacement Precautions

- When the lamp life is reached, the message "It is time to replace the lamp. Use the procedure in the User's Guide to replace the lamp as soon as possible." appears on the display for about 10 seconds, and the LAMP indicator starts to flash red in one-second intervals. Replace the lamp as soon as possible after the message appears or the LAMP indicator flashes.
- Replace the lamp with a special YL-41 replacement lamp, which should be available from your original dealer. Use only the lamp type that is specified for this projector.
- Turn off the projector. After the POWER/STANDBY indicator changes to steady (not flashing) amber, unplug the projector from the power outlet. Next, wait for at least 60 minutes before removing the lamp. Note that the lamp cartridge becomes very hot during normal use and during standby. Handling it when hot creates the risk of burn injury.
- The lamp contains mercury. Dispose of old lamps in accordance with the rules and regulations of your local jurisdiction.
- When replacing the lamp, use the special screwdriver that comes with the YL-41 replacement lamp.

Other Precautions

This projector is made of precision components. Failure to observe the following precautions can result in inability to correctly save data and malfunction.

● **Never use or store the projector in the following locations. Doing so creates the risk of malfunction of and damage to the projector.**

- Locations subjected to electrostatic charge
- Locations subjected to temperature extremes
- Locations where there is extreme moisture
- Locations subjected to sudden temperature changes
- Locations where there is a lot of dust
- On a shaky, slanted, or otherwise unstable surface
- Locations where there is the danger of getting wet

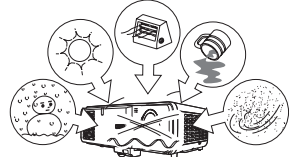

● **Avoid using the projector under the following conditions. Such conditions create the risk of malfunction of and damage to the projector.**

- Avoid areas subject to temperature extremes (operating temperature range is 5°C to 35°C (41 to 95°F)).
- Never place heavy objects on the projector or climb on top of the projector.
- Never insert or allow foreign objects to drop into the projector.
- Never place a vase or any other container of water on top of the projector.

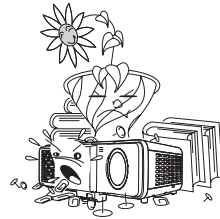

● **Never leave dead batteries inside the remote controller for a long time.**

Batteries can leak, which leads to malfunction of and damage to the remote controller.

● **Clean with a soft, dry cloth.**

When very dirty, use a soft cloth that has been dampened in a weak solution of water and a mild neutral detergent. Wring all excess water from the cloth before wiping. Never use thinner, benzene, or any other volatile agent to clean the projector. Doing so can remove its markings and cause staining of the case.

● **Missing Screen Dots**

Though this projector is manufactured using the most advanced digital technology available today, some of the dots on the screen may be missing. This is normal, and does not indicate malfunction.

● **Never subject the projector to strong impact while it is projecting.**

If the projector is accidentally subjected to strong impact, the projection image will momentarily go blank. The image will reappear after some time, but it may be the wrong color or it may be accompanied by an error message.

If the projected image is the wrong color, re-select the current input source. If this does not return the projected image to its proper color, use the procedure under "To turn off the projector" on page E-20 to turn projector power off and then back on again.

If the image reappears with an error message, correct the problem in accordance with the indicator explanations in the "Troubleshooting" guide on page E-30.

● **Keystone Correction and Image Quality**

Performing keystone correction causes the image to be compressed before it is projected. This can result distortion of the image or a loss of image quality. If this happens, change orientation of the projector and/or screen so it conforms as much as possible to the illustration under "Setting Up the Projector" on page E-14.

If image quality is the highest priority, turn off auto keystone correction and position the projector so it is pointed straight at the screen.

Operating Precautions

● Precaution when Handling the Projector after Use

Exhaust vents and the top of the projector remain very hot for some time after the projector is turned off. When handling the projector after use, grasp it from the front and back as shown in the illustration. Note that the projector has exhaust vents on the front. When handling the projector, make sure to keep your hands away from the exhaust vents in the area indicated in the illustration.

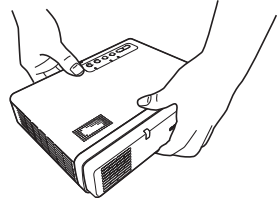

● Stowing the Projector in the Bag

When stowing the projector in the bag, orient it as shown in the illustration so the lens is facing in the direction of the bag handle.

If you turned off the projector using direct power off, make sure the projector is no longer warm before stowing it in the bag.

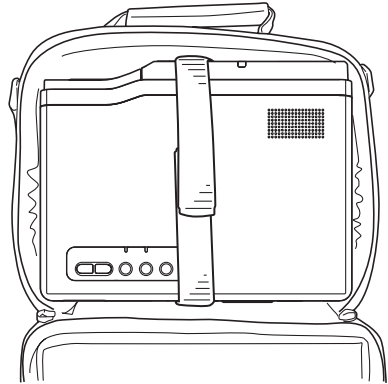

Unpacking

As you unpack the projector, check to make sure that all of the items listed below are present.

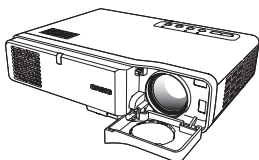

DATA PROJECTOR XJ-460/XJ-560



Remote Controller



**Test Batteries
(AA-size × 2)**



AC Power Cord



USB Cable



Video Cable



Mini D-Sub Cable

- Carrying Bag
 - CD-ROM
 - User's Guide (Basic Operations)
 - "Read this first" Sheet
 - Warranty
 - Serial Number Stickers (2) with Barcode
- * Models for the Japan market include a power plug adapter.

Using the User Documentation on the CD-ROM

The CD-ROM that comes with the projector contains a PDF file User's Guide, which contains detailed explanations about operational procedures.

In order to read the User's Guide, you need to have Adobe® Reader® installed on your computer. If you don't, visit Adobe System's Website at the URL noted below to download the latest version of Adobe Reader.

URL <http://www.adobe.com/>

To view the User's Guide contents

1. Place the bundled CD-ROM into your computer's CD-ROM drive.
2. Navigate to the CD-ROM, and open the "User's Guide" folder.
3. Double-click "UsersGuide_English.pdf".
 - This starts up Adobe Reader and displays the contents of the manual whose icon you clicked.
 - On some systems, the ".pdf" extension may not appear at the end of the file name.

Projector Features and Main Functions

- **Compact, lightweight, high-brightness data projector:** An easily portable compact configuration (278 × 64 × 214 mm / 10.9 × 2.5 × 8.4 inches), yet enough brightness (XJ-460: 2500 ANSI lumen/XJ-560: 3000 ANSI lumen) for projection even in a brightly lit room.
- **Automated Adjustment Features:** Auto Focus, auto keystone correction, and other automatic adjustment features make projection simple and more efficient.
- **Wide projection distance range, from a minimum of 0.8 meter:** Wide angle 2X zoom allows projection even when projector-to-screen distance is severely limited.
- **A selection of input sources:** Computer RGB, video device VIDEO/S-VIDEO, and component video (Y·Cb/Pb·Cr/Pr) are all supported as input sources.
- **Powerful Projection Functions:** A collection of powerful projection tools includes digital zoom for enlargement of a specific part of the projected image, picture-in-picture for overlay of a sub-image, and much more.
- **Direct Power Off:** The fan continues to operate and cool down continues for a fixed period when the power cord is unplugged immediately after turning off the projector. This lets you move the projector to another location without needing to wait for the cool down to finish.
- **Pointer:** The remote controller can be used to select one from a variety of different pointers for use during projection.
- **Multi-functional Remote Controller:** The remote controller can be used to zoom or focus the projected image, to perform mouse and page change operations on a computer connected to the projector, and more. The remote controller also has a built-in laser pointer.

General Guide

[Front/Top/Left Side]

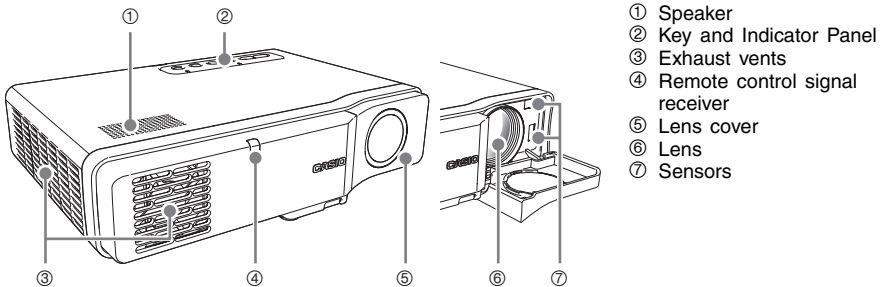

- ① Speaker
- ② Key and Indicator Panel
- ③ Exhaust vents
- ④ Remote control signal receiver
- ⑤ Lens cover
- ⑥ Lens
- ⑦ Sensors

[Key and Indicator Panel]

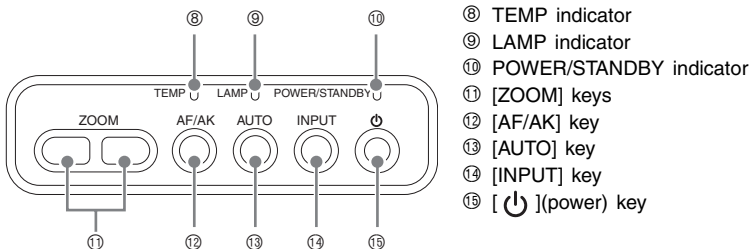

- ⑧ TEMP indicator
- ⑨ LAMP indicator
- ⑩ POWER/STANDBY indicator
- ⑪ [ZOOM] keys
- ⑫ [AF/AK] key
- ⑬ [AUTO] key
- ⑭ [INPUT] key
- ⑮ [](power) key



Warning

- Never look into the lens while the projector is turned on.
- Never allow the exhaust vents to become blocked, and make sure there is at least 30 cm (11.8 inches) clearance around the projector. Blocked vents can cause heat to build up, creating the risk of fire and malfunction.
- Never touch the areas around the exhaust vents. These areas can become very hot, and create the risk of burn injury.

Important!

- Finger smudges or dirt on the sensors can cause keystone correction problems. Should the sensors ever become soiled, wipe them clean using a commercially available lens cloth or optical lens paper, like those for eyeglasses or camera lenses.

[Bottom]

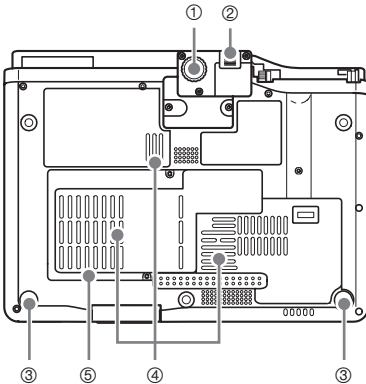

- ① Elevation adjustment foot
- ② Release button
- ③ Left, right adjustment feet (2)
- ④ Intake vents
- ⑤ Lamp cover

[Back, Terminals]

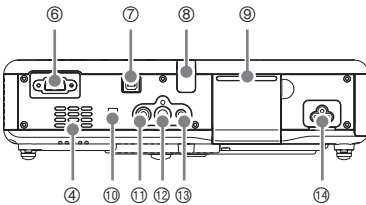

- ⑥ RGB input terminal
- ⑦ USB port
- ⑧ Remote control signal receiver
- ⑨ Projection key panel cover
- ⑩ Anti-theft lock hole
- ⑪ VIDEO input terminal
- ⑫ S-VIDEO input terminal
- ⑬ AUDIO input terminal
- ⑭ Power connector

[Projection Key Panel]

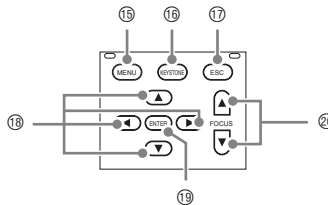

- ⑮ [MENU] key
- ⑯ [KEystone] key
- ⑰ [ESC] key
- ⑱ Cursor keys
- ⑲ [ENTER] key
- ⑳ [FOCUS] keys

<p>Warning</p>	<ul style="list-style-type: none"> ● Never allow the intake vents on the back or the bottom of the projector to become blocked. Blocked vents can cause heat to build up, creating the risk of fire and malfunction.
-----------------------	---

NOTE

- The anti-theft lock hole is provided for connection of an anti-theft chain. Visit the Kensington Lock Website at <http://www.kensington.com/> for more information.

Remote Controller General Guide

Warning

- Keep the remote controller out of the hands of young children, and never allow a young child to operate the remote controller. The laser pointer built into the remote controller can cause eye damage and loss of sight if pointed directly into a person's eyes.
- Never try to take the remote controller apart or modify it in any way. Doing so creates the risk of electric shock, burn injury, and other personal injury. Be sure to leave all internal inspection, adjustment, and repair up to your original dealer or authorized CASIO Service Center.
- Never allow the remote controller to become wet. Water creates the risk of fire and electric shock.

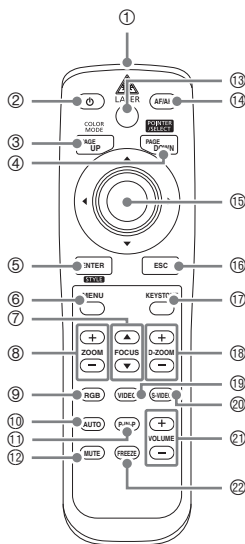

- ① Remote controller signal/laser signal emitter
- ② * [POWER] key
- ③ [PAGE UP] key ([COLOR MODE] key)
- ④ [PAGE DOWN] key ([POINTER/SELECT] key)
- ⑤ * [ENTER] key ([STYLE] key)
- ⑥ * [MENU] key
- ⑦ * [FOCUS ▲] / [FOCUS ▼] keys
- ⑧ * [ZOOM +] / [ZOOM -] keys
- ⑨ [RGB] key
- ⑩ * [AUTO] key
- ⑪ [P-IN-P] key
- ⑫ [MUTE] key
- ⑬ [LASER] key
- ⑭ * [AF/AK] key
- ⑮ * Cursor keys
- ⑯ * [ESC] key
- ⑰ * [KEystone] key
- ⑱ [D-ZOOM +] / [D-ZOOM -] keys
- ⑲ [VIDEO] key
- ⑳ [S-VIDEO] key
- ㉑ [VOL +] / [VOL -] keys
- ㉒ [FREEZE] key

CAUTION	COMPACT WITH OTHER 21 CFR SUBCHAPTER J SINE CORPUSION 20 YOSHINO-KOUME SHINJYUJANGU TOKYO JAPAN MANUFACTURE DATE: JANUARY 2005 IEC 60825-1: 6A-1,2 (2001)	LASER RICHTEIN DO NOT STARE INTO BEAM CLASS 2 LASER PRODUCT MAX OUTPUT: 1mW CLASS 2 LASER PRODUCT	LASER RICHTEIN DO NOT STARE INTO BEAM CLASS 2 LASER PRODUCT MAX OUTPUT: 1mW CLASS 2 LASER PRODUCT	RAYONNEMENT LASER NE PAS REGARDER DANS LE FAISCEAU APPAREIL A LASER DE CLASSE 2 LONGUEUR D'ONDE: 650nm PUISSANCE MAXIMA: 1mW	LASER-ERFAHLUNG NICHT IN DEN STRAHL BLICKEN LASER KLASSE 2 WELLENLÄNGE: 650nm MAX AUSGANGSLEISTUNG: 1mW
----------------	---	---	---	--	---

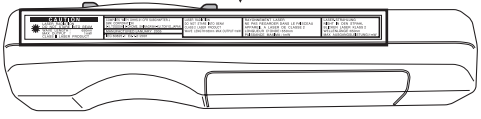

NOTE

- The asterisks (*) indicate keys that have the same names and functions as keys on the projector itself. Note that the operations of remote controller keys ⑨, ⑲, and ㉑ can be performed using the projector's [INPUT] key.
- Keys ③, ④, and ⑤ perform multiple functions. The key names used in this manual for these keys indicate the particular function being performed at that time. The name of key ⑤, for example, may be indicated as "[ENTER] key" or "[STYLE] key", depending on the type of operation being described.

Loading Remote Controller Batteries

Before you can use the remote controller for the first time, you need to load the two batteries that come with it.

Important!

- Be sure to use alkaline batteries only.

 Caution	<p>Misuse of batteries can cause them to leak and stain of the area around them, or to explode, creating the risk of fire and personal injury. Make sure that you always observe the following precautions.</p> <ul style="list-style-type: none"> ● Take care that batteries are oriented correctly when you load them. ● Never mix old batteries and new ones. ● Never mix batteries of different types. ● Use only battery type that is specified for use with the remote controller.
--	--

1. Remove the battery cover from the back of the remote controller.

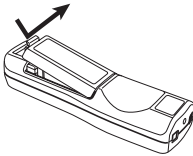

2. Load two new batteries into the case, making sure that their positive (+) and negative (-) ends are facing correctly.

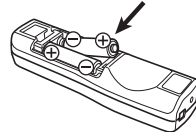



3. Replace the battery cover on the back of the remote controller.

Using the Laser Pointer

This wireless remote control unit is a Class II laser product (max. output: 1mW ; wave length: 650nm).

- Holding down the [LASER] key causes a red laser beam to be emitted from the front edge of the remote controller. Use the laser beam to point to the object you want to indicate in the image.
- The [AF/AK] key lights red while this key is depressed to indicate that the laser beam is being emitted.

 Warning	<ul style="list-style-type: none"> ● Never look directly at the laser beam. Doing so creates the risk of eye damage and loss of sight. ● Never point the laser beam at another person. Shining the laser beam into the eyes of another creates the risk of eye damage and loss of sight. ● Keep the remote controller out of the reach of young children, and never allow a young child to operate the remote controller.
--	--

 Caution	<ul style="list-style-type: none"> ● Use of controls or adjustments or performance of procedures other than those specified herein may result in hazardous radiation exposure.
--	---

Getting Ready

Setting Up the Projector

Locate the projector on a desk, table, or stand that is firm and level. Make sure to allow sufficient space around the sides and back of the projector for proper ventilation.

- The following illustrations show how the projector should be oriented for optimum projection relative to the screen.

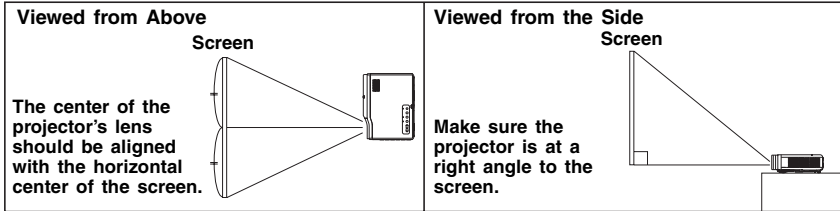

Important!

- You can place the projector on a surface that is angled up to 30 degrees up or down during use. Angling the projector more than 30 degrees up or down can cause rupture or premature aging of the projector's lamp, or malfunction of the projector.

Setup Precautions

Note that the condition of the environment where you use the projector greatly affects its performance. Make sure that the following are the conditions of projector setup whenever you use it.

- Use a conveniently located power outlet that you can reach easily when you need to unplug the projector.
- Do not place any objects within the area indicated by the dashed line in the illustration below. Be especially careful that you never block intake and exhaust vents.

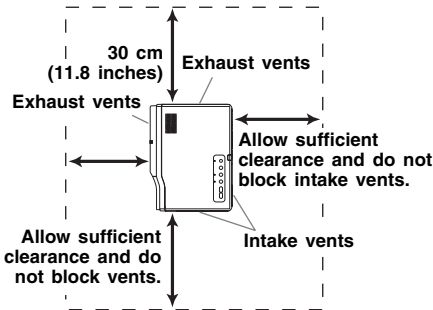

- Do not locate any objects near the projector while it is in use. Keep all items at least 30cm (11.8 inches) away from the exhaust vents.
- The vents become quite hot while the projector is in use. Never touch the vents with your hands. Also, the areas near the exhaust vents also become quite hot. Never locate objects made of plastic or other heat-sensitive materials near or under the projector. Doing so creates the risk of deformation and discoloration of the object.
- Avoid placing the projector on a surface that is unstable or prone to vibration. Never place the projector on top of a carpet, blanket, towel, or other soft material.
- Do not locate the projector where it will be exposed to direct sunlight.
- Avoid locations where there are large amounts of dust and moisture.
- Keep the projector away from speakers, TVs, radios, and other devices that generate magnetism, as well as from heaters.

A fan inside the projector draws air through an intake vent on the bottom of the projector to cool the lamp. Be sure to observe the following precautions whenever using the projector.

- Over time, use of the projector can cause dust and dirt to build up in and around the fan's intake vent, which can lead to malfunction of the projector. Be sure to check the intake vent for dust build up each time before you use the projector. If you see dirt or dust in or around the intake vent, remove it by wiping with a cloth, etc.
- When positioning the projector, make sure you do so in such a way that the intake vent on the bottom does not become blocked. A blocked intake vent can shorten the life of the lamp.

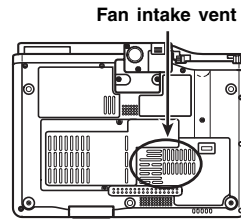

<How to Position the Projector Correctly>

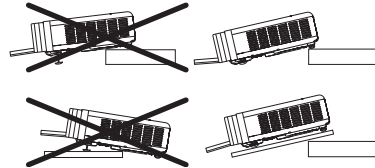

Adjusting the Projector Elevation Angle

You can change the elevation angle of the projector in a range of 0 to 8 degrees. You can also make fine adjustments to the left and right side elevation angle when necessary.

To change the projector elevation angle

1. Lift up the front of the projector and press the release button.
 - This causes the elevation adjustment foot to drop from the bottom of the projector.
2. While holding down the release button, raise and lower the front of the projector until the elevation adjustment foot is approximately the length you need.
3. Release the release button to lock the elevation adjustment foot in its current position.
4. Rotate the elevation adjustment foot for fine adjustment of its length.

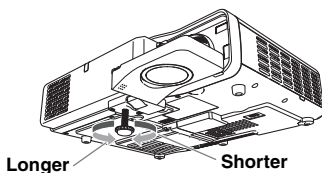
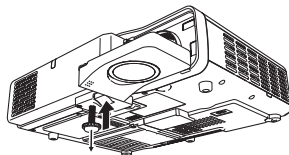

5. Use the left and right adjustment feet to further fine adjust the elevation angle.

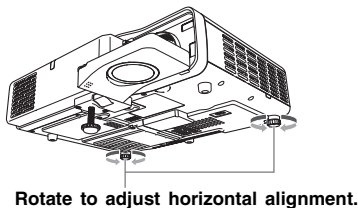

Important!

- To retract the elevation adjustment foot, hold down the release button and slide the elevation adjustment foot back into the projector. Never try to forcibly change the elevation adjustment foot position without pressing the release button.

Rear Projection (From the Back of the Screen)

In the case of rear projection, left/right orientation is opposite that of front projection, so you need to configure the setup menu accordingly. For more detailed operation information, see the User's Guide (UsersGuide_English.pdf) on the CD-ROM that comes with the projector.

Connecting a Computer to the Projector

- You can use the projector to project an image of video output from a computer.
- You can also output audio from the computer through the projector's speaker.
- After you connect a computer to the projector's USB port, you can use the remote controller to perform computer mouse operations, and previous page and next page operations.

Important!

- Always turn off the projector and the computer before connecting them.

Projector

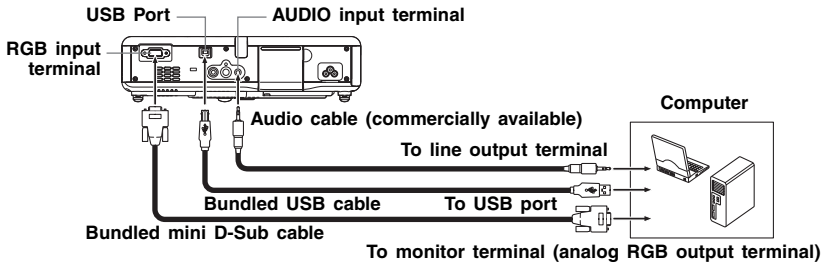

Connecting to a Standard Video Device

You can use the projector to project an image from a video deck, TV, video camera, or other video device. You can also output audio from the video device through the projector's speaker.

Important!

- Always turn off the projector and the video device before connecting them.

Projector

Video device

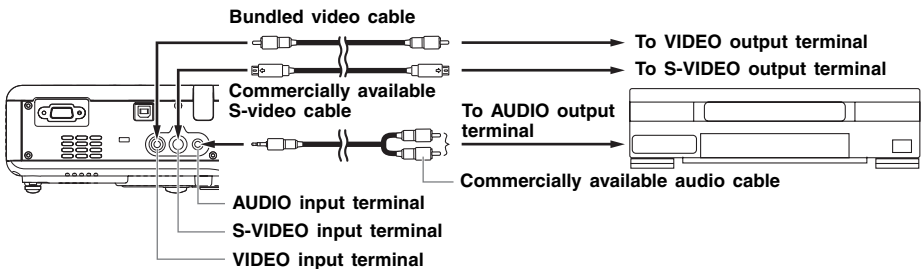

- You can use the bundled video cable to connect to a pin jack (RCA) type VIDEO output terminal. When connecting a video camera or other video device with a special video output terminal, use the special cable that comes with the video device. For details, see the documentation that comes with the video device.
- Note that the projector is equipped with separate circuits for the VIDEO input terminal and S-VIDEO input terminal. Make sure you connect the video device to the correct terminal. The projector lets you switch the input source between RGB (or Component), VIDEO, and S-VIDEO whenever you want.

Getting Ready

NOTE

- The RGB input terminal can be connected to the component video terminal of video equipment using an optionally available component video cable (YK-3). For more information, see “Connecting to a Component Video Output Device” in the User’s Guide (UsersGuide_English.pdf) on the CD-ROM that comes with the projector.
-

Turning On the Projector

Before performing any of the operations in this section, make sure you first set up the projector and connect to an output device.

AC Power Cord Precautions

- Use the AC power cord that comes with the projector.
- Make sure that you use a power source with the same voltage as that specified for the projector.
- Do not share the outlet supplying power to the projector with other devices. If you are using an extension cord, make sure that the ampere rating of the extension cord is compatible with the power consumption value of this projector.
- Never use the power cord while it is still bundled together.
- Never place objects on top of the power cord and do not step on it.
- Never pull on the power cord. When unplugging it, grasp the plug.
- Use a conveniently located power outlet that you can reach easily when you need to unplug the projector.
- If you need more information about the power supply, contact your original dealer or authorized CASIO service center.

To turn on the projector

1. Use the bundled AC power cord to plug the projector into a power outlet.
 - Plugging into a power outlet causes the three indicators on the top of the projector to light amber. After a short while, two of the indicators will go out and only the POWER/STANDBY indicator will remain lit amber, which indicates the standby state.
 - Note that the projector will not turn on if you press the [⏻] (power) key while all three indicators are lit amber. Wait until the projector is in the standby state before trying to turn it on.

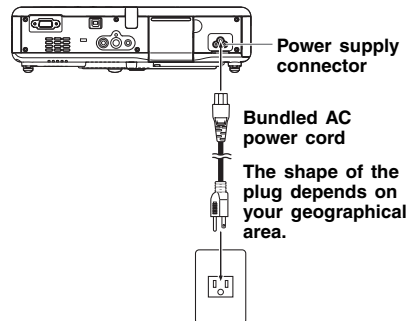

NOTE

- This product is also designed for IT power distribution system with phase-to-phase voltage 230V.
-

2. Turn on the computer or video device that is connected to the projector.
3. If the projector’s lens cover is closed, open it.

4. Press the  (power) key.

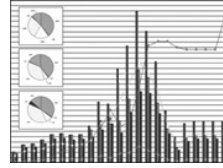

Input image projection

- This causes the POWER/STANDBY indicator to flash green, which indicates that the projector is warming up.
- After warm up is complete, POWER/STANDBY indicator stops flashing and remains lit green, and the projector starts projecting an image from the device connected to it. It normally takes about 60 seconds from the point that warm up starts until an image is projected from the connected device.
- A “Language” window will be projected the first time you turn on the projector. Use the procedure under “Specifying the Display Message Language” on the page E-20 to configure the language settings.

 **NOTE**



- If the projector is configured for low-noise mode operation, the LAMP indicator lights green when warm up starts. Note that low-noise operation is supported by the XJ-560 model only. The XJ-460 does not have a low-noise mode.
- If the projector is hot when you plug the AC power cord into a power outlet, it will go into a cool down state. The cool down state is indicated by the POWER/STANDBY indicator flashing orange.
Note that the projector will not turn on until cool down is complete, even if you press the  (power) key.
The projector will turn on and enter the standby state after cool down is complete.
- The password feature lets you limit use of the projector to specific individuals. For more information, see “Option Settings 1 → Power On Password” in the User’s Guide (UsersGuide_English.pdf) on the CD-ROM that comes with the projector.

Getting Ready

Specifying the Display Message Language

A “Language” window will be projected the first time you turn on the projector. Use the menu on this screen to specify the display language you want to use.

1. Use the cursor [▲] and [▼] keys to highlight the language you want to use.

If the serial number starts with this letter:	You can select from among these languages:
A	English, French, German, Italian, Spanish, Swedish, Korean, Japanese 
B	English, Spanish, Chinese (Simplified), Chinese (Traditional), Japanese 

2. Press the [ENTER] key.

Turning Off the Projector

Caution

- When you turn off the projector, the lamp goes out and the projector goes into a cool down state. Note that you will not be able to turn the projector back on again while it is cooling down.
- The projector may remain quite hot for a while after you turn it off. Take care when moving the projector or otherwise handling it after use. See “Precaution when Handling the Projector after Use” (page E-8) for more information.
- Note that the projector may still be quite warm even after it completes its cool down procedure. Before packing up the projector, it is recommended that you check to make sure that the fan is stopped.

To turn off the projector

1. Press the [⏻] (power) key.
 - This causes the confirmation message “Do you want to turn off the projector?” to appear in the center of the projection screen.
 - If you do not turn off the projector the confirmation message will disappear automatically after about 10 seconds. The confirmation message will also disappear if you press [ESC] key.

2. To turn off the projector, press the [⏻] (power) key again in response to the confirmation message.
 - This causes the projector lamp to go out and stops projection.
 - Also the POWER/STANDBY indicator starts to flash amber, which indicates that the projector is cooling down.
 - The projector will not turn back on again while it is cooling down.
 - After cool down is finished, the POWER/STANDBY indicator on the top of the projector will light amber, which indicates the standby state. You can now turn the projector back on, if you want.
3. Unplug the AC power cord from the power outlet.
 - This causes the POWER/STANDBY indicator to go out.
4. After ensuring that the projector and the connected computer or video device are turned off, disconnect the connecting cables from the projector and the connected device.
5. Close the lens cover.

 **NOTE**

- After confirming that the cool down operation described in step 2 is complete, unplug the power cord from the power outlet. Note that if you unplug the power cord while the cool down operation is in progress, the projector's fan will continue and perform a Direct Power Off. For more information, see "Direct Power Off".

Direct Power Off

Even if you unplug the projector from a power outlet while the cool down operation is in progress, the projector's fan will continue and perform a Direct Power Off.

Important!

- The projector may still be hot, especially around its sides and front, after Direct Power Off is complete. Take care when handling the projector after Direct Power Off. Before packing up the projector, it is recommended that you check to make sure that the projector is no longer warm.

Auto Power Off

Auto Power Off automatically turns off the projector whenever there is no input signal from the currently selected input source, and no operation is performed on the projector for about 30 minutes. When Auto Power Off is triggered, the projector first enters a cool down state, the same as it does when you press the [⏻] (power) key to turn it off.

Projection Operations

For detailed information about projection operations, see the User's Guide (UsersGuide_English.pdf) on the CD-ROM that comes with the projector.

Projecting onto a Screen

Auto Input Source Selection

When you turn on the projector, it checks the status of each input source (whether or not the input source is sending a signal) in the sequence shown below. It automatically selects the first input source it finds that is sending an input signal, and projects the applicable image.

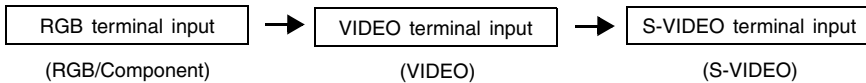

Manually Selecting the Input Source

The procedure you should use to select the input source depends on whether you are using projector keys or remote controller keys.

- To select the input source using projector keys, press the [INPUT] key on the projector to cycle through input sources in the sequence shown below.



- To select the input source using remote controller keys, press the [RGB/COMPONENT], [VIDEO], or [S-VIDEO] key on the remote controller to select the input source you want. The currently selected input source name is shown in the upper right corner of the projection screen.

Zoom and Focus

Use the [ZOOM] keys to adjust the image size, and the [FOCUS ▲]/[FOCUS ▼] keys to focus the image.

To adjust image size

1. Hold down the [ZOOM +] key to increase the size of the image or the [ZOOM -] key to decrease it.
 - This causes the zoom indicator, which indicates the current zoom setting, to appear on the image.
2. Release the [ZOOM] key when the image is the size you want.
 - The zoom indicator will disappear from the image automatically if you do not perform any further key operation for a certain amount of time.

To focus the image

1. Hold down [FOCUS ▲] or [FOCUS ▼] to adjust the focus.
 - This causes the focus indicator, which indicates the current focus setting, to appear on the image.
2. When the focus is the way you want, release the [FOCUS] key.
 - The focus indicator will disappear from the image automatically if you do not perform any further key operation for a certain amount of time.

NOTE

- The focus and zoom indicators may not appear under certain conditions (when the startup logo is displayed, when the image and audio are muted, during password input, etc.). Though the indicators do not appear, focus and zoom adjustment can still be performed by pressing the applicable keys.

Auto Adjustment of an RGB Image

When the input source is RGB (computer), the projector automatically adjusts vertical and horizontal positioning, frequency, and phase whenever it detects an RGB signal (following input source selection, power up, etc.). You can also execute an automatic adjustment operation by pressing the [AUTO] key.

NOTE

- You can turn off auto adjustment when you want to disable auto adjustment and maintain manual settings.
- The projected image may become distorted while an auto adjustment operation is in progress.
- If an image is unclear following the auto adjustment operation, you can use the menu to adjust items manually.

Keystone Correction (AF/AK, KEYSTONE)

When the projector is at an angle to the screen it is projecting on, the projected image may have different length left and right edges, or top and bottom edges. This phenomenon is called, "keystoneing". This projector comes with functions for automatic as well as manual keystone correction, which provides a regularly shaped projected image.

Important!

- Keystone correction can cause the corrected image to be smaller than the original (uncorrected) image, or it can cause distortion of the image. If the projected image becomes difficult to view, try moving the screen and/or projector so they are oriented close to the configuration shown under "Setting Up the Projector" on page E-14.

Performing Auto Focus and Auto Keystone Correction

Pressing the [AF/AK] key while the AF/AK Mode (initial default) is assigned to it causes both Auto Focus and auto keystone correction to be performed.

NOTE

- The [AF/AK] key can be configured to perform one of the three Auto Focus (AF) and auto keystone correction operations described below. For information about configuring the [AF/AK] key operation, see "Option Settings 2 → AF/AK Mode" in the User's Guide on the CD-ROM that comes with the projector.
 - **AF/AK Mode (initial default):** Pressing the [AF/AK] key performs both keystone correction and Auto Focus.
 - **Continuous AF/AK Mode:** Pressing the [AF/AK] key projects an alignment chart that comes in handy when the projection distance is relatively far or when projecting at an angle. With the Continuous AF/AK mode, the projector continually performs Auto Focus as the projector is moved.
 - **AF Mode:** Pressing the [AF/AK] key again performs Auto Focus only.

Manual Keystone Correction (KEYSTONE)

1. Press the [KEYSTONE] key.
 - This causes the keystone correction screen to appear on the projected image.
2. Use the [▲] and [▼] keys to select the keystone correction setting you want to change, and then use the [◀] and [▶] keys to correct for keystoneing.

Projection Operations

Auto Focus (AF)

At times, the projector may not focus properly when you press the [AF/AK] key. This can be caused by local environmental factors, etc. If this happens, focus the image manually or try performing the AF operation again. If you often need to adjust focus manually, perform the steps under “To adjust Auto Focus”, below.

Note that the allowable distance for Auto Focus is less than that for manual focus.

To adjust Auto Focus

1. Position the projector and screen so they are about 1.5 meters apart, and then press the **[⏻]**(power) key to turn on the projector.
 - Position the projector so it is pointed straight at the screen.
2. Press the [AF/AK] key.
3. Press the [KEystone] key and then use the screen that appears to change the vertical and horizontal keystone correction values to zero.
 - This step is not necessary if these values are already zero.
4. Use the [FOCUS] keys to adjust focus manually.
5. While the focus indicator is being projected, hold down the [ENTER] key for about five seconds.
 - After about five seconds, the message “Focus operation successful.” or “Focus operation failed.” is projected.
6. If the focus operation fails, repeat the above procedure from step 2.

Auto Keystone Correction

Certain operational environments and other factors can make it impossible to achieve sufficient accuracy when performing keystone correction.

If an image appears distorted after performing auto keystone correction check the sensors for dirt and clean them if necessary. See the User's Guide (UsersGuide_English.pdf) on the CD-ROM that comes with the projector for more information.

If this does not solve the problem, try changing the position of the projector slightly or perform manual keystone correction.

AF/AK at Short Projection Distances

Performing the AF/AK (Auto Focus, auto keystone correction) operation when there is sharp angle and when there is only a short distance between the projector and screen can result in the left and right edges of the image to be out of focus. If this happens, reduce the angle or increase the distance between the projector and screen.

Using the Setup Menu

Pressing the [MENU] key while an image is being projected displays the setup menu on the projected image. The setup menu can be used to configure a variety of different projector settings. Use the cursor keys to select and configure settings, and the [ENTER] key to register them.

The menu items that can be set (or displayed) depend on the current input source. In the following table, the "Input Source" columns indicate whether each item appears (○) or not (×) for each input source (R = RGB, C = Component, S = S-VIDEO, V = Video, - = No input signal). A triangle (△) indicates that the item can be set (or displayed), subject to certain conditions.

Main menu Sub-menu	Input Source				
	R	C	S	V	-
Image Adjustment					
Brightness	○	○	○	○	×
Contrast	○	○	○	○	×
Sharpness	×	○	○	○	×
Saturation	×	○	○	○	×
Tint	×	×	△	△	×
Color Mode	○	○	○	○	×
Color Balance	○	○	○	○	×
Vertical Position	○	○	○	○	×
Horizontal Position	○	○	○	○	×
Frequency	○	×	×	×	×
Phase	○	×	×	×	×
Noise Filter	○	×	×	×	×
Restore Menu Defaults	○	○	○	○	×
Volume Adjustment					
Volume	○	○	○	○	△
Restore Menu Defaults	○	○	○	○	○
Screen Settings					
Vertical Keystone Correction	○	○	○	○	○
Horizontal Keystone Correction	○	○	○	○	○
Aspect Ratio	×	△	○	○	×
Resize Image To Fit	○	×	×	×	×
Projection Mode	○	○	○	○	○
Ceiling Mount	○	○	○	○	○
Startup Screen	○	○	○	○	○
No Signal Screen	○	○	○	○	○
Mute Screen	○	○	○	○	○
Restore Menu Defaults	○	○	○	○	○
Input Settings					
RGB Input	○	○	×	×	△
Video Signal	×	×	×	○	△
S-Video Signal	×	×	○	×	△
P-in-P Input	○	○	×	×	△
Signal Name Indicator	○	○	○	○	○
Special Signal	○	×	×	×	△
Restore Menu Defaults	○	○	○	○	○

Main menu Sub-menu	Input Source				
	R	C	S	V	-
Option Settings 1					
Auto Input Detect	○	○	○	○	○
Auto Adjust	○	×	×	×	△
Low-noise Mode (XJ-560 only)	○	○	○	○	○
Auto Power Off	○	○	○	○	○
Key Lock	○	○	○	○	○
Power On Password	○	○	○	○	○
Custom Logo Settings	○	○	○	○	×
Language	○	○	○	○	○
Alert Tones	○	○	○	○	○
Restore Menu Defaults	○	○	○	○	○
Option Settings 2					
AF/AK Mode	○	○	○	○	○
Power On AF/AK Mode	○	○	○	○	○
Zoom Memory	○	○	○	○	○
Pointer	○	○	○	○	○
Restore Menu Defaults	○	○	○	○	○
Operational Info					
Lamp Time	○	○	○	○	○
Reset Lamp Time	○	○	○	○	○
Input Signal	○	○	○	○	○
Signal Name	○	○	○	○	×
Index	○	○	×	×	×
Resolution	○	×	×	×	×
Horizontal Frequency	○	○	○	○	×
Vertical Frequency	○	○	○	○	×
Scan System	○	○	×	×	×
Restore All Defaults	○	○	○	○	○

For detailed information about settings and how they are configured, see the User's Guide (UsersGuide_English.pdf) on the CD-ROM that comes with the projector.

User Maintenance

Cleaning the Projector

Important!

- Always turn off the projector before cleaning it.

Periodically clean the projector exterior, lens, sensors, intake vents, and exhaust vents on a regular basis. For details about the cleaning procedure, see “Cleaning the Projector” in the User’s Guide (UsersGuide_English.pdf) on the CD-ROM that comes with the projector.

Reattaching the Lens Cover

If the lens cover becomes detached, see “Reattaching the Lens Cover” in the User’s Guide (UsersGuide_English.pdf) on the CD-ROM that comes with the projector.

Replacing the Lamp

⚠ Caution

- Continued use of a lamp that has passed its lamp life increases the risk of the lamp rupturing. Replace the lamp with a new one as soon as possible after the replacement message appears.

- The light source lamp is a consumable item. The average life of a lamp is approximately 2000 hours. After 2000 hours, a message appears to alert you to the need of lamp replacement. However, note that the characteristics of a particular lamp or lamp operating conditions can cause the lamp to start to go dim or even fail before the message appears.

To check the current lamp use time

1. Press the [MENU] key to display the setup menu.
2. Press the [▼] key to select the “Operational Info” main menu.
 - The “Lamp Time” sub-menu item shows the number of hours that the current lamp has been used.
3. Press the [MENU] key to exit the setup menu.

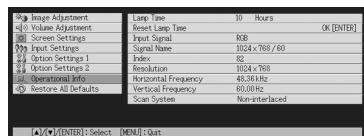

Image Adjustment	Lamp Time	10 Hours	
Volume Adjustment	Reset Lamp Time		OK [ENTER]
Screen Settings	Input Signal	RGB	
Input Settings	Signal Name	1024 x 768 / 60	
Option Settings 1	Index	92	
Option Settings 2	Resolution	1024 x 768	
Operational Info	Horizontal Frequency	48.00 kHz	
Restore All to Defaults	Vertical Frequency	60.00 Hz	
	Scan System	Non-interlaced	

When to replace the lamp

The LAMP indicator starts to flash red and the message shown below appears whenever the lamp time exceeds 2000 hours.

It is time to replace the lamp. Use the procedure in the User’s Guide to replace the lamp as soon as possible.

When this message appears, replace the lamp as soon as possible using the procedure under “Replacing the Lamp” on page E-27.

Note that the above message will disappear about 10 seconds after you turn on the projector, even if you do not replace the lamp.

You will be able to continue using the projector without replacing the lamp until the lamp time reaches 100 hours. At that time, the LAMP indicator will stop flashing and remain lit red, the following message will appear for about 10 seconds, and then the projector will turn off automatically.

The lamp has exceeded its service life! The projector will not turn on until you replace the lamp.

When this message appears, replace the lamp immediately using the procedure under “Replacing the Lamp” on page E-27.

Replacing the Lamp

 Caution	<ul style="list-style-type: none"> ● During normal use, the lamp and the area around it become extremely hot. Before replacing the lamp, turn off the projector and wait for the cool down operation (indicated when the POWER/STANDBY indicator is flashing amber) to finish. Next, disconnect the AC power cord from the projector, and wait for at least 60 minutes to allow it to cool down even further. Touching the lamp or the area around it during operation or immediately after turning off the projector creates the risk of serious burn injury. ● Replace the lamp using the YL-41 optional lamp cartridge only. ● The projector uses a mercury lamp with high internal pressure as its light source. A lamp that is weakened by impact, damage, or expiration of its lamp life may explode or fail to light. Note that the performance of the lamp differs greatly from lamp to lamp, and due to conditions under which a lamp is used. ● Never touch the glass of the lamp with your fingers. Doing so can cause the lamp to rupture and shorten its life. ● A broken lamp can cause glass fragments to be scattered inside the lamp housing. Gas inside of the lamp housing may also be discharged from the projector's vent exhaust ports. Gas inside of the lamp includes mercury, so be sure to ventilate the area whenever the lamp breaks. Should you accidentally inhale gas fumes or should gas fumes get into your eyes, immediately contact a physician. ● Should the lamp break, take care to avoid personal injury on the glass fragments. Never try to replace a broken lamp on your own. Be sure to contact your original dealer or authorized CASIO service center to request replacement. ● The lamp contains mercury. Dispose of old lamps in accordance with the rules and regulations of your local jurisdiction.
--	--

Important!

- Disposing of the Lamp (U.S.A. Only)

This product utilizes a lamp containing mercury. Disposal of the lamp may be regulated due to environmental considerations. For disposal or recycling information, please contact your local authorities or the Electronic Industries Alliance: <http://www.eiae.org>.

To replace the lamp

Important!

- When replacing the lamp, use the special screwdriver that comes with the YL-41 replacement lamp. The projector does not come with a screwdriver.

1. Turn off the projector and unplug its AC power cord.
2. Wait for about 60 minutes to allow the projector's current lamp to cool down completely.
3. Turn over the projector and place it on top of a desk or on some other stable surface.

User Maintenance

4. Loosen the lamp cover screws, and then remove the lamp cover.

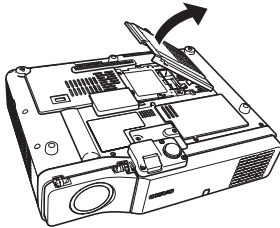
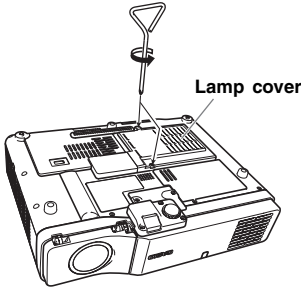

6. Use the lamp cartridge handle to pull the lamp cartridge from the projector.

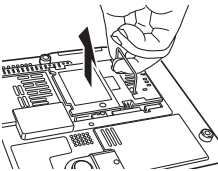

5. Loosen the three screws securing the lamp cartridge.

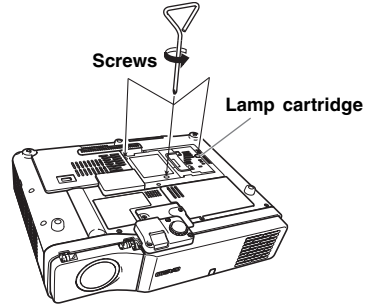

7. Insert the new lamp cartridge as far as it will go, as shown in the illustration.
- After inserting the lamp cartridge, lay its handle down in the position shown in the illustration under step 5 on this page.

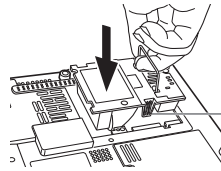

Make sure the grooves on either side of the lamp cartridge align with the grooves of the lamp housing.

Caution

- Never touch the lamp with your hand. Doing so can cause the lamp to rupture and shorten its life.
-

8. Secure the lamp cartridge with the three screws.

9. Return the lamp cover to its original position, and secure it with the two screws.
- After replacing the lamp, be sure to perform the procedure under "Resetting the Lamp Time" on page E-29.

Resetting the Lamp Time

The lamp time reset operation you need to perform depends on when you replace the lamp.

It is time to replace the lamp. Use the procedure in the User's Guide to replace the lamp as soon as possible.

If you replace the lamp when the above message appears, use the procedure under "To reset the lamp time".

The lamp has exceeded its service life! The projector will not turn on until you replace the lamp.

If you replace the lamp after the above message appears, use the procedure under "To reset the lamp time after exceeding the lamp life".

To reset the lamp time

1. Turn on the projector.
2. Press the [MENU] key to display the setup menu.
3. Press the [▼] key to select "Operational Info", and then press the [ENTER] key.
4. Press the [ENTER] key.
 - This causes the message "Reset lamp time?" to appear.
5. Press the [▲] key to select "Yes", and then press the [ENTER] key.
 - This resets the lamp time to 0 hours.
6. Press the [MENU] key to exit the setup menu.
 - This causes the setup menu to disappear from the projected image.

To reset the lamp time after exceeding the lamp life

If you use the existing lamp until its life is exceeded, you will not be able to turn on the projector even after you replace the lamp with a new one. Perform the following procedure to initialize the lamp time in this case, which will make it possible to turn on the projector.

1. Use the bundled AC power cord to plug the projector into a power outlet.
 - Connecting to a power outlet causes the POWER/STANDBY and LAMP indicators on the top of the projector to light red, which indicates that the lamp has exceeded its service life.
2. While holding down the projector's [◀] key, hold down the [AUTO] key for about five seconds.
 - This will reset the lamp time, cause the POWER/STANDBY indicator to change from red to amber, and also cause the LAMP indicator to go out.
3. Press the [⏻] (power) key to ensure that the projector turns on normally.

Troubleshooting

Indicators and Alert Tones

The status of the indicators lets you know the current operational status of the projector. This section provides details about indicators, and about the error alert tones.

- “POWER” in the following table stands for the “POWER/STANDBY” indicator.

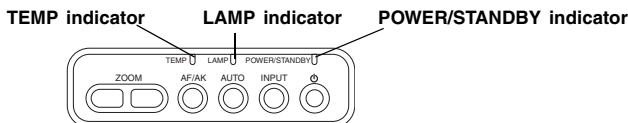

Normal Operation Indicators

When this indicator:	Is this:	It means this:
POWER : TEMP : LAMP :	Amber steady	You have just plugged the AC power cord into a power outlet. Wait until the projector enters the standby state (see below) before trying to turn on power.
POWER :	Amber steady	Standby state: The AC power cord is plugged in and the projector is in standby.
POWER :	Green flashing	Projector is warming up after being turned on.
POWER :	Green steady	Projector is on and standing by for use.
POWER :	Amber flashing	Projector is cooling down after being turned off. If the projector is hot when you plug the AC power cord into a power outlet, it also goes into a cool down state.
LAMP :	Green steady	Projector is in the low noise mode.

Error Indicators

- “○” in the “Alert” column indicates that the projector will emit four long beeps when an error occurs. “△” in the “Alert” column indicates that the projector will emit two short beeps when an error occurs. Note that alert tones sound only when “On” is specified for “Option Settings 1 → Alert Tones”.
- When an error occurs, wait until cool down is complete and the fan stops before unplugging the AC power cord. If you unplug the AC power cord while the fan is still operating, an error may occur when you plug the AC power cord back in.

Indicator/Alert	Description
POWER : Amber flashing → Red steady TEMP : Red steady Alert : ○	An operational problem was caused by external noise or some other factor. After confirming that the POWER/STANDBY indicator is lit red (steady) and that the fan has stopped, unplug the AC power cord. After the indicator goes out, plug the AC power cord back in and turn on the projector again. If the error occurs again when you turn power back on, contact your original dealer or authorized CASIO Service Center.
POWER : Amber flashing → Red steady TEMP : Red flashing (0.5-second interval) Alert : ○	There is some problem with the fan. Perform the same procedure described above.

Indicator/Alert	Description
POWER : Amber flashing → Red steady TEMP : Red flashing (1-second interval) Alert : ○	Power has turned off automatically due to internal overheating. Perform the following steps. ① After confirming that the POWER/STANDBY indicator is lit red, unplug the AC power cord and wait for about 60 minutes to allow the projector to cool down. ② Check for any blocking of the projector's intake vents and exhaust vents, and make sure that there is sufficient space around the projector. ☞ "Setup Precautions" (page E-15). ③ Clean dust accumulated around the projector's intake vents and exhaust vents. ☞ See "Cleaning the Projector" section in the User's Guide (UsersGuide_English.pdf) on the bundled CD-ROM. ④ Plug the AC power cord back in, and turn on the projector again.
POWER : Amber flashing → Red steady TEMP : Red flashing (0.5-second interval) LAMP : Red flashing (0.5-second interval) Alert : ○	Power has turned off automatically due to a lamp problem. After confirming that the POWER/STANDBY indicator is lit red, unplug the AC power cord, then plug it back in and turn on the projector again. If this does not correct the problem, wait for the projector to cool down and then check the lamp cartridge for damage. If there is nothing wrong with the lamp cartridge, take it to your original dealer or authorized CASIO Service Center.
POWER : Amber flashing → Red steady TEMP : Amber flashing Alert : ○	Power has turned off automatically because the lamp cover is open. Perform the following steps. ① After confirming that the POWER/STANDBY indicator is lit red, unplug the AC power cord and wait for about 60 minutes to allow the projector to cool down. ② Close the lamp cover. ☞ "To replace the lamp" (page E-27). ③ Plug the AC power cord back in, and turn on the projector again.
POWER : Amber flashing → Red steady TEMP : Red flashing (2-second interval) Alert : ○	Internal memory error. After confirming that the POWER/STANDBY indicator is lit red, unplug the AC power cord, wait for about 60 minutes to allow the projector to cool down, and then take it to your original dealer or authorized CASIO Service Center.
POWER : Green steady LAMP : Red flashing (1-second interval) Alert : △	It is time to replace the lamp. Replace the lamp following the steps under "Replacing the Lamp" on page E-27.
POWER : Amber flashing → Red steady LAMP : Red steady Alert : ○	The allowable life for the lamp has been exceeded, and the projector will not turn on. Replace the lamp following the steps under "Replacing the Lamp" on page E-27.

Projector Troubleshooting

Check the "Projector Troubleshooting" section in the User's Guide (UsersGuide_English.pdf) on the bundled CD-ROM whenever you experience any problem with the projector.

Specifications

Model Name		XJ-460/XJ-560
Projection System		DLP (DMD, single panel)
DMD	Size	0.7inch
	Number of Pixels	XGA (1024 × 768)
Projection Lens		Auto, optical zoom (×2); auto focus F = 2.0 to 2.8 f = 20 to 40mm
Light Source		270W high-pressure mercury lamp
RGB input terminal		RGB mini D-Sub 15-pin × 1 (Also used as component signal input terminal.)
VIDEO input terminal		RCA pin jack × 1
S-VIDEO input terminal		Mini DIN4-pin × 1
Audio Input Terminal		Stereo mini jack × 1
Audio Output		1W monaural
USB port		USB TYPE B
Environment		Operating Temperature: 5 to 35°C (41 to 95°F) Operating Humidity: 20 to 80% (non-condensation)
Power Requirements		XJ-560: 100-240V AC, 50/60Hz, 4.1A-1.8A XJ-460: 100-240V AC, 50/60Hz, 3.5A-1.5A
Dimensions		278(W) × 64(H) × 214(D) mm (excluding projections) (10.9 × 2.5 × 8.4 inches)
Weight		Approximately 2.7kg (6.0 lbs)
Display Languages		A Model: English, French, German, Italian, Spanish, Swedish, Korean, Japanese B Model: English, Spanish, Chinese (Simplified), Chinese (Traditional), Japanese
Low-noise mode		XJ-560: Supported (Use the setup menu to turn the low-noise mode on or off.) XJ-460: Not supported

* Specifications are subject to change without notice.