

# USING A MEMORY CARD

You can expand the storage capabilities of your camera by using a commercially available memory card (SD memory card or MultiMedia Card). You can also copy files from built-in flash memory to a memory card and from a memory card to flash memory.

- Normally, files are stored in built-in flash memory. When you insert a memory card, however, the camera automatically stores files to the card.
- Note that you cannot save files to built-in memory while a memory card is installed in the camera.

## ▶▶ IMPORTANT! ◀◀

- Make sure you turn off the camera before inserting or removing a memory card.
- Be sure to orient the card correctly when inserting it. Never try to force a memory card into the slot when you feel resistance.
- See the instructions that come with the memory card for information about how to use it.
- Certain types of cards can slow down processing speeds.
- SD memory cards have a write protect switch, which you can use to protect against accidental deletion of image data. Note, however, that if you write protect an SD memory card, you must remove write protection whenever you want to record to it, format it, or delete any of its files.

## Using a Memory Card

### To insert a memory card into the camera

1. Open the memory card cover.

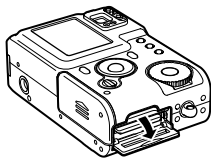

2. Positioning the memory card so its cut off corner is oriented as shown in the illustration, push the memory card into slot as far as it will go.

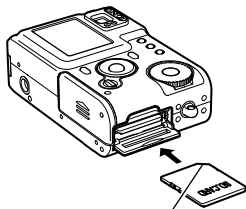

*Cut off corner*

3. Close the memory card cover.

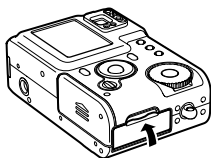

### To remove a memory card from the camera

1. Open the memory card cover.
2. Press the memory card into the camera and then release it. This will cause the card to come part way out of the camera.

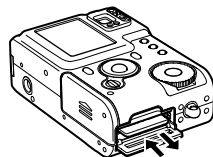

3. Pull the memory card out of the slot.

#### ▶▶ IMPORTANT! ◀◀

- Never insert any other object besides a memory card into the camera's card slot. Doing so creates the risk of damage to the camera and card.
- Should water or any foreign object ever get into the card slot, immediately turn off the camera, remove the battery, and contact your dealer or nearest CASIO service center.
- Never remove a card from the camera while the green operation lamp is flashing. Doing so can cause the file save operation to fail, and even damage the memory card.

### Formatting a Memory Card

Formatting a memory card deletes any data already stored on it.

#### ▶▶ IMPORTANT! ◀◀

- Be sure to use the camera to format a memory card. Formatting a memory card on a computer and then using it in the camera can slow down data processing by the camera. In the case of an SD card, formatting on a computer can result in nonconformity with the SD format, causing problems with compatibility, operation, etc.
- Note that data deleted by a memory card format operation cannot be recovered. Check to make sure you do not need any of the data on the memory card before you format it.
- Formatting a memory card that contains files deletes all the files, even those that are protected (page 92).

1. Load the memory card into the camera.
2. Turn on the camera. Next, enter a recording mode or the Play Mode, and then press MENU.
3. Select the “Set Up” tab, select “Format,” and then press [>].
4. Select “Format,” and then press SET.
  - To exit the format operation without formatting, select “Cancel.”

### Memory Card Precautions

- Use only an SD memory card or a MultiMedia Card with this camera. Proper operation is not guaranteed when any other type of card is used.
- Electrostatic charge, electrical noise, and other phenomena can cause data to become corrupted or even lost. Always make sure that you always back up important data on other media (MO disc, computer hard disk, etc.)
- If a memory card starts to behave abnormally, you can restore normal operation by reformatting it. However, we recommend that you always take along more than one memory card whenever using the camera far away from the home or office.
- We recommend that you format a memory card before using it for the first time after purchasing it, or whenever the card you are using seems to be the cause of abnormal images.
- Before starting a format operation, connect the AC adaptor for power or check to make sure that the battery is at full charge. Power interruption during the format operation can result in improper formatting, and even damage the memory card and make it unusable.

### Copying Files

Use the procedures below to copy files between built-in memory and a memory card. You can copy all files from built-in memory to a memory card, or you can copy a single file from the memory card to built-in memory.

#### To copy all the files in built-in memory to a memory card

1. Load the memory card into the camera.
2. Turn on the camera. Next, enter the Play Mode, and then press MENU.
3. Select the “PLAY” tab, select “Copy,” and then press [>].

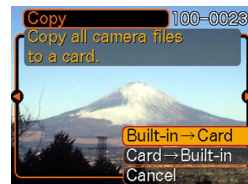

### 4. Use [^] and [v] to select “Built-in → Card,” and then press SET.

- This starts the copy operation and displays the message “Busy.... Please wait...”
- After the copy operation is complete, the monitor screen shows the last file in the folder.

### To copy a file from a memory card to built-in memory

1. Perform steps 1 through 3 of the procedure under “To copy all the files in built-in memory to a memory card.”
2. Use [^] and [v] to select “Card → Built-in,” and then press SET.
3. Use [<] and [>] to scroll through images until the one you want to copy is on the monitor screen.
4. Use [^] and [v] to select “Copy,” and then press SET.
  - This starts the copy operation and displays the message “Busy.... Please wait...”
  - The file reappears on the monitor screen after the copy operation is complete.
  - Repeat steps 3 through 4 to copy other images, if you want.
5. Press MENU to exit the copy operation.

### »» NOTE ««

- Files are copied to the folder in built-in memory whose name has the largest number.

# USING THE CAMERA WITH A COMPUTER

The USB cable that comes with your camera makes it easy to connect to a computer that is equipped with a USB port. You can also transfer images using the memory card, if your computer is equipped to read memory cards.

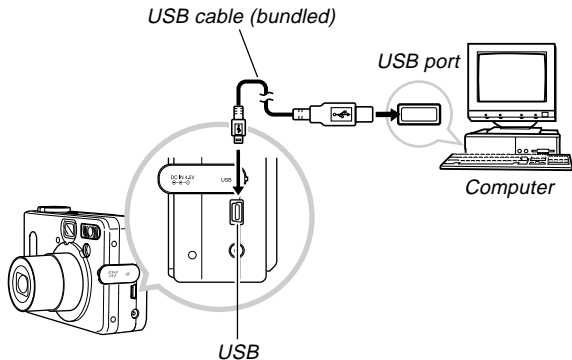

## Installing the Software from the CD-ROM

Before you can exchange files with your computer, you first need to install the software contained on the CD-ROM that comes with the camera.

## About the bundled CD-ROM

The CD-ROM that comes bundled with the camera contains the following software.

### Photo Loader (for Windows/Macintosh)

This application loads image data saved in JPEG and AVI format from a digital camera onto your computer.

### Photohands (for Windows)

This application is for retouching and printing image files.

### USB Driver for Mass Storage (for Windows/Macintosh)

This is the software that makes it possible for the camera to "talk" to your personal computer over a USB connection. If you are using Windows XP, Mac OS 9, or Mac OS X, do not install the USB driver from the CD-ROM. With these operating systems, you will be able to perform USB communication simply by connecting the camera to your computer with the USB cable.

### Internet Explorer (for Macintosh)

This is a browser application for reading HTML files. Images loaded by Photo Loader are stored in folders called “Libraries.” Internet Explorer displays the contents of a library on your computer screen.

### DirectX (for Windows)

This software provides an extended tool set including a codec that allows Windows 98 and 2000 to handle movie files recorded using a digital camera. You do not need to install DirectX if you are running Windows XP or Me.

### Acrobat Reader (for Windows/Macintosh)

This is an application that lets you read PDF files. Use it to read the user documentation for the camera, Photo Loader, and Photohands, all of which is included on the bundled CD-ROM.

### NOTE

- See the user documentation files (PDF) on the bundled CD-ROM for details about using Photo Loader and Photohands. See “Viewing User Documentation (PDF files)” on page 114 (Windows) and page 117 (Macintosh) of this manual for more information.

## Computer System Requirements

Computer system requirements depend on each of the applications, as described below.

### Windows

See the “Readme” file on the bundled CD-ROM.

### Macintosh

See the “readme” file on the bundled CD-ROM.



### Installing Software from the CD-ROM in Windows

Use the procedures in this section to install the software from the bundled CD-ROM to your computer.

#### NOTE

- You do not need to install software if you already have it installed on your computer.

The CD-ROM includes the software and user documentation for various languages. Check the CD-ROM menu screen to see if applications and user documentation are available for a particular language.

### Getting Started

Start up your computer and insert the CD-ROM into its CD-ROM drive. This will automatically launch the menu application, which displays a menu screen on your computer.



#### NOTE

- The menu application may not start up automatically on some computers. If this happens, navigate to the CD-ROM and double-click “menu.exe” to launch the menu application.

### Selecting a Language

First select a language. Note that some software is not available in all languages.

- On the menu screen, click the language button in the upper left corner of the display.
- On the list of languages that appears, select the one you want.

## Viewing the Contents of the “Read me” File

You should always read the “Read me” file for any application before installing it. The “Read me” file contains information you need to know when installing the application.

1. On the menu screen, click “Software.”
2. Click the name of the application you want to install.
3. Click the “Read me” button.

### »» IMPORTANT! ««

- Before upgrading or reinstalling Photo Loader, or before installing it onto another computer, be sure to read the “Read me” file for information about retaining existing libraries.

## Installing an Application

1. On the menu screen, click “Software.”
2. Click the name of the application you want to install.
3. Click the “Install” button.
4. Follow the instructions that appear on your computer screen.

### »» IMPORTANT! ««

- Be sure to follow the instructions carefully and completely. If you make a mistake when installing Photo Loader, you may not be able to browse your existing library information and HTML files that are created automatically by Photo Loader. In some cases, image files may be lost.
- When using an operating system other than Windows XP, never connect the camera to your computer without installing the USB driver from the CD-ROM first.

## Viewing User Documentation (PDF Files)

1. On the menu screen, click “Manual.”
2. Click the name of the application whose user documentation you want to read.
3. Click the “Read” button.

### ▶▶ IMPORTANT! ◀◀

- You need to have Adobe Acrobat Reader installed on your computer to read user documentation files. If you do not already have Adobe Acrobat Reader installed, you can install it from the bundled CD-ROM.

## Exiting the Menu Application

1. On the menu screen, click “Exit” to exit the menu.

## Installing Software from the CD-ROM on a Macintosh

The CD-ROM contains applications and user documentation in various languages in folders named for each language: English, French, German, Spanish, Italian, Dutch, and Chinese. Check the CD-ROM folders to find out if applications and user documentation are available in a particular language.

File names include one of the following codes that indicate the language of the data contained in the file as shown below.

English: e, French: f, German: g, Spanish: sp, Italian: i, Dutch: du, Chinese: ct

If your language is not included in the above, use the contents of the “English” folder.

## Installing Software

Use the following procedures to install the software. We recommend that you install Internet Explorer and Outlook Express first before installing Photo Loader and Acrobat Reader.

■ **To install Internet Explorer and Outlook Express**

1. Open the file named “Internet Explorer.”
2. Open the folder for the language version you want to install, and then open the file named “readme\_casio” file.
3. Follow the instructions in the read me file to install Internet Explorer and Outlook Express.

■ **To install Photo Loader**

1. Open the folder named “Photo Loader.”
2. Open the folder named “English,” and then open the file named “Important.”
3. Open the folder named “Installer,” and then open the file named “readme.”
4. Follow the instructions in the “readme” file to install Photo Loader.

►► **IMPORTANT!** ◀◀

- If you are upgrading to the new version of Photo Loader from a previous version and you want to use library management data and HTML files created using the old version of Photo Loader, be sure to read the “Important” file in the “Photo Loader” folder. Follow the instructions in the file to use your existing library management files. Failure to follow this procedure correctly can result in loss or corruption of your existing files.

■ **To install Acrobat Reader**

1. On the bundled CD-ROM, open the folder named “Acrobat Reader.”
2. Open the folder for the language whose version of Acrobat Reader you want to install, and then open the file named “readme\_casio.”
  - Follow the instructions in the read me file to install Acrobat Reader.

## ■ Installing the USB Driver

1. Turn off the camera and quit all applications on your Macintosh.
2. Insert the bundled CD-ROM provided into the CD-ROM drive.
3. Open the hard disk that is specified as the startup disk.
4. Open the “System Folder” on the startup disk.
5. Open the “Extensions” folder inside the “System Folder.”
6. Open the “USB Driver” folder on the CD-ROM.
7. Drag “CASIO-USB Storage Driver” and “CASIO-USB Storage Class Shim” from the “USB Driver” folder to the “Extensions” folder.
8. Confirm that the “CASIO-USB Storage Driver” file and “CASIO-USB Storage Class Shim” file are in the “Extensions” folder, and then restart your Macintosh.

9. After the system starts up, use the USB cable to connect the camera to your Macintosh.

10. Turn on the camera.

11. From now on, the camera will be recognized as a drive whenever you connect the camera to your Macintosh.

- The shape of the icon that appears on your Macintosh display depends on the version of your Mac OS.



### »» IMPORTANT! ««

- If you are running an operating system other than Mac OS 9 or Mac OS X, do not connect the camera to your Macintosh PC without installing the USB driver first.
- **To uninstall the USB driver**  
Delete “CASIO-USB Storage Driver” and “CASIO-USB Storage Class Shim” from the “Extensions” folder.

## Viewing User Documentation (PDF Files)

To perform the following procedures, you must have Acrobat Reader installed on your Macintosh (page 115).

1. On the bundled CD-ROM, open the folder named “Acrobat Reader.”
2. Open the folder for the language whose version of Acrobat Reader you want to install, and then open the file named “readme\_casio.”
3. Follow the instructions in the read me file to install Acrobat Reader.

### ■ To view the camera user’s guide

1. On the CD-ROM, open the “Manual” folder.
2. Open the “Digital Camera” folder, and then open the folder for the language whose user’s guide you want to view.
3. Open the file named “camera\_xx.pdf.”
4. “xx” is the language code (English: e, French: f, German: g, Spanish: sp, Italian: i, Dutch: du, Chinese: ct).

### ■ To read the Photo Loader user’s guide

1. On the CD-ROM, open the “Manual” folder.
2. Open the “Photo Loader” folder and then open the “English” folder.
3. Open “PhotoLoader\_english.”

### Transferring Files to a Computer

The CD-ROM that comes bundled with your camera contains a copy of Photo Loader and a USB driver. This software lets you transfer the contents of the camera's memory to your computer quickly and easily. The Photo Loader and Photohands applications can also be used for high-level image management and editing.

- For information about using Photo Loader and Photohands, see their user documentation files (PDF) on the bundled CD-ROM.

### Transferring Files Over a USB Connection

You can transfer images to a computer with a USB port simply by connecting the camera to the computer with the USB cable.

- Note that you need to install a USB driver on your computer the first time you try to connect. Once you use the cable to establish a USB connection, the computer sees the camera as an external storage device (card reader/writer).
- If you plan to transfer file data from the camera's built-in memory to your computer, make sure there is no memory card loaded in the camera. If there is, remove the memory card from the camera before you connect the USB cable.

#### NOTE

- Do not install the USB driver from the CD-ROM onto a computer running Windows XP, Mac OS 9, or Mac OS X. With these operating systems, USB communication becomes enabled simply by connecting the camera to the computer with the USB cable.

### ■ To connect the USB Cable

1. Turn on the camera.
2. Open the terminal panel cover and then use the USB cable to connect the camera to the computer.

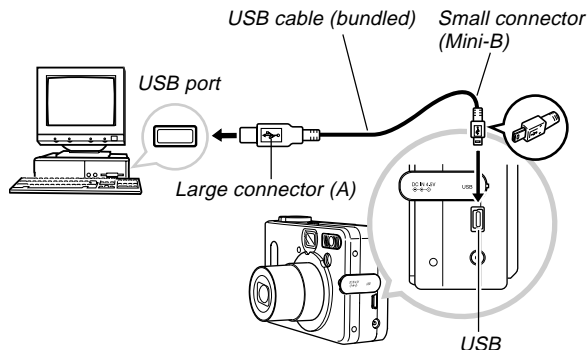

3. Import the images to the computer.
4. After image data transfer is complete, disconnect the USB cable.
  - For details, see "Terminating a USB Connection."

### ▶▶ IMPORTANT! ◀◀

- Be sure to read the applicable information in the user documentation that comes with your computer before connecting the USB cable.
- Do not leave the same image displayed on your computer screen for a long time. Doing so can cause the image to "burn in" on the screen.
- Take care when connecting the USB cable to the camera. The USB port and the cable plug are shaped for proper positioning.
- Plug the USB cable into the ports securely as far as it will go. Proper operation is not possible if connections are not correct.
- The camera does not draw power over the USB cable. Be sure to connect the AC adaptor to the camera for power.
- The optionally available CASIO QC-1U USB cable cannot be used with this camera.
- Never disconnect the USB cable while the PC is accessing camera memory (indicated by a flashing USB lamp). Doing so can cause data to become corrupted.
- You can perform USB data communication while the camera is in a recording mode or in the Play Mode.



### ■ Terminating a USB Connection

#### **Windows Me or 98**

Disconnect the USB cable from the camera, and then turn off the camera.

#### **Windows XP or 2000**

Click card services in the task tray on your computer screen, and disable the drive number assigned to the camera. Next, disconnect the USB cable from the camera, and then turn off the camera.

#### **Macintosh**

In Finder, drag the camera to the trashcan. Next, disconnect the USB cable from the camera and then turn off the camera.

### Transferring Files Using a Memory Card

The procedures in this section describe how to transfer images from the camera to your computer using a memory card.

- **Using a Computer with a Built-in SD Memory Card Slot**  
Insert the SD memory card directly into the slot.

- **Using a Computer with a Built-in PC Card Slot**  
Use a commercially available PC card adapter (for an SD memory card/MMC). For full details, see the user documentation that comes with the PC card adapter and your computer.

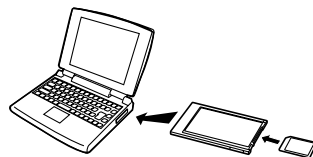

### ● Using a Commercially Available SD Memory Card Reader/Writer

See the user documentation that comes with the SD memory card reader/writer for details about how to use it.

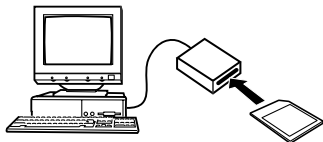

### ● Using a Commercially Available PC Card Reader/Writer and PC Card Adapter (for SD Memory Cards and MMCs)

See the user documentation that comes with the PC card reader/writer and PC card adapter (for an SD memory card/MMC) for details about how to use them.

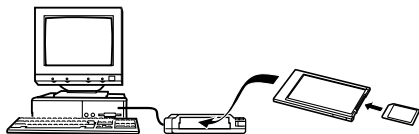

## Memory Data

Images recorded with this camera and other data are stored in memory using DCF (Design Rule for Camera File System) protocol. DCF protocol is designed to make it easier to exchange image and other data between digital cameras and other devices.

### ■ DCF Protocol

DCF devices (digital cameras, printers, etc.) can exchange images with each other. DCF protocol defines camera format for image file data and the directory structure for camera memory, so images can be viewed using another manufacturer's DCF camera or printed on a DCF printer.

## Memory Directory Structure

### ■ Directory Structure

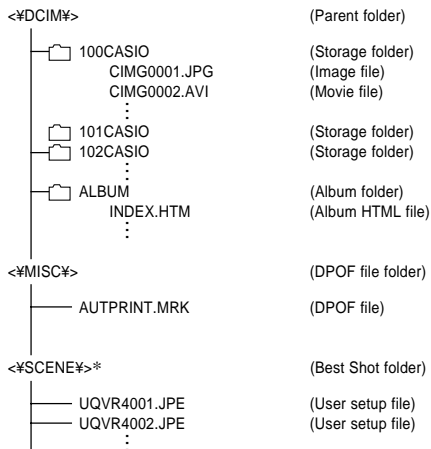

\* <¥SCENE¥> is created for built-in memory only.

### ■ Folder and File Contents

- Parent folder  
Folder that stores all of the digital camera files.
- Storage folder  
Folders for storing files stored with the digital camera.
- Image file  
File that contains an image recorded with the digital camera.
- Movie file  
File that contains a movie recorded with the digital camera.
- Album folder  
Folder that contains files used by the album function.
- Album HTML file  
File used by the album function.
- DPOF file folder  
Folder that contains DPOF files.
- Best Shot folder (Built-in memory only)  
Folder that contains Best Shot user setup files.
- User setup files (Built-in memory only)  
Files that contain user setups used by the Best Shot Mode.

### Supported Image Files

- Image files recorded with the CASIO QV-R3/QV-R4 Digital Camera
- DCF protocol image files

Certain DCF functions may not be supported. When displaying an image recorded on another camera model, it may take a long time for the image to appear on the display.

### Built-in Memory and Memory Card Precautions

- Note that the folder named “DCIM” is the parent (top) folder of all the files in memory. When transferring memory contents to a hard disk, MO disk, or other external storage, treat all the contents inside a DCIM folder as a set and always keep them together. You can change the name of the DCIM folder on your computer. Changing the name to a date is a good way to keep track of multiple DCIM folders. However, be sure you change the name of the DCIM folder back to “DCIM” before you copy it back to camera memory for playback on the camera. The camera does not recognize any folder name other than DCIM.
- We also strongly recommend that after transferring data from memory to other external storage that you reformat memory and delete its contents before using it to store more files. Remember that formatting memory deletes all of its contents. Check to make sure that you no longer need any of the files in memory before you format it.

### Using the Album Feature

The album feature of the camera creates an HTML layout that displays your images. You can use the HTML layout to post your images on a Web page, or for printing the images.

- You can use the Web browser shown below to view or print the contents of an album. Note that to view a movie on a computer running Windows 2000 or 98, you need to install DirectX.

Microsoft Internet Explorer Ver 5.5 or later

### Creating an album

1. In the Play Mode, press .

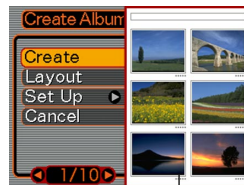

*Sample layout*

2. Use  $[\wedge]$  and  $[\vee]$  to select “Create,” and then press SET.

- This starts creation of the album, and causes the message “Busy.... Please wait...” to appear on the monitor screen.
- After creation of the album is complete, press the MENU button to exit the menu screen.
- Creating an album causes a file folder named “ALBUM,” which contains a file named “INDEX.HTM” plus other files to be created in camera memory or on the memory card.

### »» IMPORTANT! ««

- Never open the battery cover or remove the memory card from the camera while an album is being created. Doing so not only runs the risk of certain album files being skipped, it can also result in image data and other data in memory being corrupted.
- If memory becomes full while an album is being created, the message “Memory Full” appears on the monitor screen and album creation is terminated.
- Album creation will not be performed properly if the battery goes dead while album creation is in progress.
- You can also configure the camera to create albums automatically (page 127). However, performing the above procedure creates an album regardless of whether automatic album creation is turned on or off.

## Selecting an Album Layout



You can select from among 10 different display layouts for an album.

1. In the Play Mode, press .
2. Use [^] and [v] to select “Layout.”
3. Use [<] and [>] to select the layout you want.
  - Changing the layout causes the layout sample on the right side of the screen to change.

### »» IMPORTANT! ««

- The sample layout shows the arrangement of items and the background color. It does not show whether the layout uses a list view or detailed view, or if hot linking is turned on or off.

## Configuring Detailed Album Settings

1. In the Play Mode, press .
  2. Use [^] and [v] to select “Set Up,” and then press [>].
- 
3. Use [^] and [v] to select the item whose setting you want to change, and then press [>].
    - Details about each of the settings are provided in the following sections.
  4. Use [^] and [v] to change the setting, and then press SET.

### ■ Background Color

You can specify white, black, or gray as the color of the album background using the procedure under “Configuring Detailed Album Settings.”

### ■ Album Type

There are two album types: Normal and Index/Info.

**Normal Type** : This type of album displays images in accordance with the currently selected layout.

**Index/Info Type** : In addition to the normal album screen, this type of album also includes thumbnails of images and detailed information about each image.

### ■ Hot Linking On/Off

This setting controls whether or not you can enlarge movies, or play movies or audio files from your Web browser. Each image in the album represents either a still image or a movie. When hot linking is turned on, clicking an album image displays the corresponding still image or plays the corresponding movie. This setting lets you turn album image hot linking on or off.

## USING THE CAMERA WITH A COMPUTER

To get this:	Select this hot linking setting:
High-resolution album images when printing album pages <b>»» NOTES ««</b> <ul style="list-style-type: none"><li>• Since images are high resolution, it takes a longer time to display them on your computer screen.</li><li>• With this setting, you cannot enlarge images or play movies.</li></ul>	Off
Lower resolution album images for album browsing and publishing thumbnails on a Website <b>»» NOTES ««</b> <ul style="list-style-type: none"><li>• Clicking an image displays its enlarged version, which you can use for viewing and printing.</li><li>• With this setting, clicking an AVI file image plays the movie.</li></ul>	On

### ■ Auto Album Creation On/Off

This setting controls whether an album is created automatically whenever you turn off the camera.

To do this:	Select this option:
Turn off auto album creation	Off
Turn on auto album creation	On

- When auto album creation is turned on, an album is created automatically in built-in memory or on the memory card whenever you turn off the camera.

### »» IMPORTANT! ««

- When you turn off the camera while auto album creation is turned on, the monitor screen turns off, but the operation lamp continues to flash for a few seconds to indicate that the album creation process is being performed. Never open the battery cover or remove the memory card while the green operation lamp is flashing.

### »» NOTE ««

- Depending on the number of images in memory, it can take quite a bit of time to complete auto album creation when you turn off the camera. If you do not plan to use the album feature, we suggest that you keep auto album creation turned off, which shortens the amount of time the camera takes to power down completely.



## Viewing Album Files

You can view and print album files using your computer's Web browser application.

1. Use your computer to access the data in built-in memory or on the memory card, or access a memory card with your computer (pages 118 and 120).
2. Open the built-in memory "ALBUM" folder or the memory card "ALBUM" folder, which is located inside the folder named "DCIM."
3. Use your computer's Web browser to open the file named "INDEX.HTM."

- This displays a list of folders in built-in memory or on the memory card.

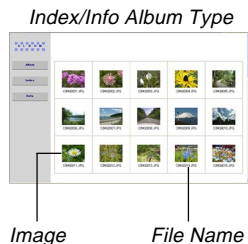

4. If you created the album after selecting "Normal" type or "Index/Info" as the album type under "Configuring Detailed Album Settings" on page 126, you can click one of the following display options.

Album : Displays an album created by the camera.

Index : Displays a list of images stored in a folder.

Info : Displays information about each image.

- If hot linking is turned on for the album, you can double-click an image on your computer screen to display the full-size version.

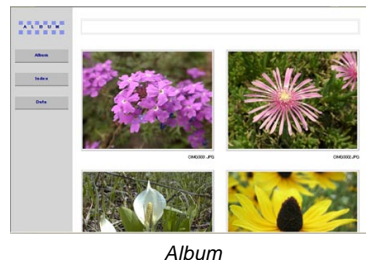

## USING THE CAMERA WITH A COMPUTER



Index

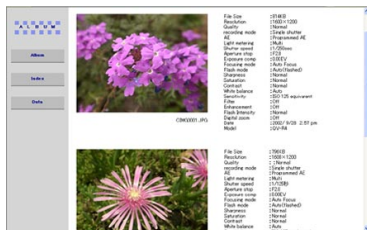

Info

- The following describes the information that appears on the Info Screen.

This Info Screen item:	Shows this:
File Size	Image file size
Resolution	Resolution
Quality	Quality
Drive mode	Drive mode
AE	Exposure mode
Light metering	Metering mode
Shutter speed	Shutter speed
Aperture stop	Aperture stop
Exposure comp	Exposure compensation
Focusing mode	Focusing mode
Flash mode	Flash mode
Sharpness	Sharpness
Saturation	Saturation
Contrast	Contrast
White balance	White balance
Sensitivity	Sensitivity
Filter	Filter setting
Enhancement	Enhancement setting
Flash intensity	Flash intensity
Digital zoom	Digital zoom setting
World	Location
Date	Recording date and time
Model	Camera model name

### »» NOTES ««

- When printing an album page, you should set up your Web browser as described below.
  - Select the browser frame where the images are located.
  - Set margins to the lowest possible values.
  - Set the background color to a printable color.
- See the user documentation that came with your Web browser application for details about printing and configuring settings for printing.

### **5. After you are finished viewing the album, exit your Web browser application.**

## Saving an Album

- To save an album, copy the “DCIM” folder from camera memory or the memory card to your computer’s hard disk, a floppy diskette, an MO disk, or some other storage medium. Note that copying only the “ALBUM” folder, does not copy image data and other necessary files.
- After copying the “DCIM” folder, do not change or delete any of the files inside of it. Adding new images or deleting existing images may lead to abnormal album display.
- If you plan to use a memory card again after saving its album, first delete all of its files or format it before loading it into the camera.





# APPENDIX

## Menu Reference

The tables in this section show the items that appear on each recording mode and Play Mode tab. Underlined items are factory defaults.

## Recording Mode Menu

### ● REC tab menu

Size	QV-R3: <u>2048</u> × <u>1536</u> / 1600 × 1200 / 1280 × 960 / 640 × 480 QV-R4: 2304 × 1712 / <u>2240</u> × <u>1680</u> / 1600 × 1200 / 1280 × 960 / 640 × 480
Quality	Fine / <u>Normal</u> / Economy
White Balance	<u>Auto</u> /  (Sunlight) /  (Shade) /  (Light Bulb) /  (Fluorescent) / Manual
ISO	QV-R3: <u>Auto</u> / ISO 125 / ISO 250 QV-R4: <u>Auto</u> / ISO 100 / ISO 200
Metering	<u>Multi</u> / Center weighted / Spot
Filter	<u>Off</u> / B/W / Sepia / Red / Green / Blue / Yellow / Pink / Purple
Enhance	<u>Off</u> / Red / Green / Blue / Flesh Tone
Sharpness	Soft / <u>Normal</u> / Hard
Saturation	Low / <u>Normal</u> / High
Contrast	Low / <u>Normal</u> / High

Flash Intensity	Weak / <u>Normal</u> / Strong
Grid	<u>Off</u> / On
Digital Zoom	Off / <u>On</u>

### ● Memory tab menu

Flash	<u>On</u> / Off
Focus	On / <u>Off</u>
White Balance	On / <u>Off</u>
ISO	On / <u>Off</u>
Metering	On / <u>Off</u>
Flash Intensity	On / <u>Off</u>
Digital Zoom	<u>On</u> / Off
MF Position	On / <u>Off</u>

## ● Set Up tab menu

File No.	<u>On</u> / Off
Beep	<u>On</u> / Off
Startup	<u>On (Selectable image)</u> / Off
World Time	<u>Home</u> / World
	Home time setup (city, DST, etc.)
	World Time setup (city, DST, etc.)
Date Style	<u>YY/MM/DD</u> / DD/MM/YY / MM/DD/YY
Adjust	Time setting
Language	日本語 / <u>English</u> / Français / Deutsch / Español / Italiano
Sleep	30 sec / <u>1 min</u> / 2 min / Off
Auto Power Off	<u>3 min</u> / 5 min / Off
Format	Format / <u>Cancel</u>
Reset	Reset / <u>Cancel</u>

## PLAY Mode Menu

## ● PLAY tab menu

Resize	1280 × 960 / 640 × 480 / Cancel
Trimming	—
Alarm	Alarm setups
Copy	Built-in → Card / Card → Built-in / Cancel

## ● Set Up tab menu

File No.	<u>On</u> / Off
Beep	<u>On</u> / Off
Startup	<u>On (Selectable image)</u> / Off
World Time	<u>Home</u> / World
	Home time setup (city, DST, etc.)
	World Time setup (city, DST, etc.)
Date Style	<u>YY/MM/DD</u> / DD/MM/YY / MM/DD/YY
Adjust	Time setting
Language	日本語 / <u>English</u> / Français / Deutsch / Español / Italiano
Sleep	30 sec / <u>1 min</u> / 2 min / Off
Auto Power Off	<u>3 min</u> / 5 min / Off
Format	Format / <u>Cancel</u>
Reset	Reset / <u>Cancel</u>

## Indicator Lamp Reference

The camera has three indicator lamps: a green operation lamp, a red operation lamp, and a self-timer lamp. These lamps light and flash to indicate the current operational status of the camera.

Green operation lamp

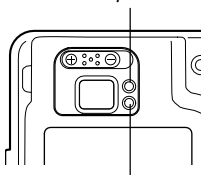

Red operation lamp

Self-timer lamp

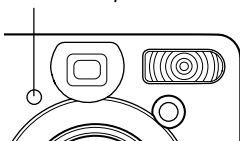

\* There are three lamp flash patterns. Pattern 1 flashes once per second, Pattern 2 flashes twice per second, and Pattern 3 flashes four times per second. The table below explains what each flash pattern indicates.

## Recording Mode

Operation Lamp		Self-timer Lamp	Meaning
Green	Red	Red	
Lit			Operational (Power on, recording enabled)
Pattern 1	Pattern 1		Interval recording is stopped.
	Pattern 3		Flash is charging.
	Lit		Flash charging is complete.
Lit			Auto Focus operation was successful.
Pattern 3			Cannot Auto Focus.
Lit			Monitor screen is off.
Pattern 2	Pattern 2		Storing image
Pattern 1	Pattern 1		Storing movie
		Pattern 1	Self-timer countdown (10 to 3 seconds)
		Pattern 2	Self-timer countdown (3 to 0 seconds)
	Pattern 1		Cannot charge flash.
	Pattern 2		Memory card problem / Memory card is unformatted. / Best Shot setup cannot be registered.
	Lit		Memory card is locked / Cannot create folder. / Memory is full. / Write error

Operation Lamp		Self-timer Lamp	Meaning
Green	Red	Red	
	Pattern 3		Low battery alert
Pattern 3			Formatting card
Pattern 3			Powering down

### ▶▶ IMPORTANT! ◀◀

- When you are using a memory card, never remove the card from the camera while the green operation lamp is flashing. Doing so will cause recorded images to be lost.

## Play Mode

Operation Lamp		Self-timer Lamp	Meaning
Green	Red	Red	
Lit			Operational (Power on, recording enabled)
Pattern 1			Interval recording is stopped.
Pattern 3			One of the following operations is being performed: delete, DPOF, image protect, copy, album creation, format, power down
	Pattern 2		Memory card problem / Memory card is unformatted.
	Lit		Memory card is locked / Cannot create folder. / Memory is full.
	Pattern 3		Low battery alert

## Charger Unit

The charger unit has a CHARGE lamp that lights or flashes in accordance with the charger unit operation that is being performed.

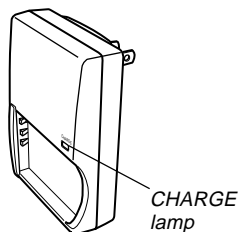

CHARGE Lamp		Meaning
Green	Red	
	Lit	Charging
Lit		Charging complete
	Pattern 1	Charging problem (Ambient temperature is too high or too low.)
	Pattern 3	Charger unit or battery abnormality



## Troubleshooting Guide

	Symptom	Possible Cause	Action
Power Supply	Power does not turn on.	<ol style="list-style-type: none"> <li>1) The battery is not oriented correctly.</li> <li>2) The battery is dead.</li> </ol>	<ol style="list-style-type: none"> <li>1) Orient the battery correctly (page 25).</li> <li>2) Charge the battery (page 24). If the battery goes dead soon after being charged, it means the battery has reached the end of its life and needs to be replaced. Purchase a separately available NP-30 rechargeable lithium ion battery.</li> </ol>
	Camera suddenly powers down.	<ol style="list-style-type: none"> <li>1) Auto Power Off activated (page 33).</li> <li>2) The battery is dead.</li> </ol>	<ol style="list-style-type: none"> <li>1) Turn power back on.</li> <li>2) Charge the battery (page 24).</li> </ol>
Image Recording	Image is not recorded when the shutter release button is pressed.	<ol style="list-style-type: none"> <li>1) The mode dial is set to  (Play Mode).</li> <li>2) Flash unit is being charged.</li> <li>3) Memory is full.</li> </ol>	<ol style="list-style-type: none"> <li>1) Use the mode dial to select a recording mode (page 38).</li> <li>2) Wait until the flash unit finishes charging.</li> <li>3) Transfer files you want to keep to your computer and then delete files from camera memory, or use a different memory card.</li> </ol>
	Auto Focus does not focus properly	<ol style="list-style-type: none"> <li>1) The lens is dirty.</li> <li>2) The subject is not located in the center of the focus frame when you compose the image.</li> <li>3) The subject you are shooting is a type that is not compatible with Auto Focus operation (page 41).</li> <li>4) You are moving the camera.</li> </ol>	<ol style="list-style-type: none"> <li>1) Clean the lens.</li> <li>2) Make sure the subject is centered in the focus frame when composing the image.</li> <li>3) Use manual focus (page 55).</li> <li>4) Mount the camera on a tripod.</li> </ol>

## APPENDIX

	Symptom	Possible Cause	Action
Image Recording	The subject is out of focus in the recorded image.	The image is not focused properly.	When composing the image, make sure the subject on which you want to focus is located inside the focus frame.
	Camera powers down during self-timer countdown.	The battery is dead.	Charge the battery (page 24).
	Monitor screen image is out of focus.	<ol style="list-style-type: none"> <li>1) You are using the Manual Focus Mode and have not focused the image.</li> <li>2) You are trying to use the Macro Mode when shooting a scenery or portrait shot.</li> <li>3) You are trying to use Auto Focus or the Infinity Mode (<math>\infty</math>) when shooting a close-up shot.</li> </ol>	<ol style="list-style-type: none"> <li>1) Focus the image (page 55).</li> <li>2) Use Auto Focus for scenery and portrait shots.</li> <li>3) Use the Macro Mode for close-ups.</li> </ol>
	Recorded images are not saved in memory.	<ol style="list-style-type: none"> <li>1) Camera powers down before the save operation is complete.</li> <li>2) Removing the memory card before the save operation is complete.</li> </ol>	<ol style="list-style-type: none"> <li>1) When the battery indicator shows , charge the battery as soon as possible (page 24).</li> <li>2) Do not remove the memory card before the save operation is complete.</li> </ol>
Playback	Color of the playback image is different from the image on the monitor screen during recording.	Sunlight or light from another source is shining directly into the lens during recording.	Position the camera so sunlight does not shine directly into the lens.

## APPENDIX

	Symptom	Possible Cause	Action
Playback	Images are not displayed.	A memory card with non-DCF images recorded with another camera is loaded in the camera.	This camera cannot display non-DCF images recorded onto a memory card using another digital camera.
Other	All buttons and switches are disabled.	Circuit problem caused by electrostatic charge, impact, etc. while the camera was connected to another device.	Remove the battery from the camera, reinsert it, and then try again.
	Monitor screen is off.	<ol style="list-style-type: none"> <li>1) USB communication is in progress.</li> <li>2) The monitor screen is turned off (in a recording mode).</li> </ol>	<ol style="list-style-type: none"> <li>1) After confirming that the computer is not accessing camera memory, disconnect the USB cable.</li> <li>2) Press DISP to turn on the monitor screen.</li> </ol>
	Cannot transfer files over a USB connection.	<ol style="list-style-type: none"> <li>1) USB cable is not connected securely.</li> <li>2) USB driver is not installed.</li> <li>3) Camera is turned off.</li> </ol>	<ol style="list-style-type: none"> <li>1) Check all connections.</li> <li>2) Install the USB driver on your computer (page 110).</li> <li>3) Turn on the camera.</li> </ol>

## Display Messages

<b>Battery is low.</b>	The battery is dead.	<b>The card is locked.</b>	The LOCK switch of the SD memory card is locked. You cannot store images to or delete images from a memory card that is locked.
<b>BEST SHOT memory is full.</b>	You are attempting to register a Best Shot setup when the "SCENE" folder already contains 999 set-ups.	<b>The card is not formatted.</b>	The memory card is not formatted. Format the memory card (page 106).
<b>Card ERROR</b>	Some problem occurred with the memory card. Turn off the camera, and remove and then reinsert the memory card. If the same message appears, format the memory card (page 106).  <b>»» IMPORTANT! ««</b> Formatting the memory card deletes all files on the memory card. Before formatting, try transferring recoverable files to a computer or some other storage device.	<b>The function is not supported for this file.</b>	The function you are trying to perform is not supported for the file on which you are trying to perform it.
<b>Folder cannot be created.</b>	This message appears when you try to record an image while there are 9,999 files stored in the 999th folder. If you want to record more files, delete files you no longer need (page 89).	<b>There are no files.</b>	There are no files in built-in memory or on the memory card.
<b>Memory Full</b>	Memory is full. If you want to record more files, delete files you no longer need (page 89).	<b>This file cannot be played.</b>	The image file or audio file is corrupted, or is a type that cannot be displayed by this camera.
<b>Record Error</b>	Image compression could not be performed during image data storage for some reason. Record the image again.	<b>This function cannot be used.</b>	You attempted to copy files from built-in memory to a memory card while there is no memory card loaded in the camera (page 107).
<b>SYSTEM ERROR</b>	Your camera system is corrupted. Contact your retailer or a CASIO service center.		

## Specifications

### Main Specifications

**Product:** ..... Digital Camera

**Model:** ..... QV-R3/QV-R4

### ■ Camera Functions

#### Image Files Format

Snapshots: ..... JPEG (Exif Ver.2.2); DCF (Design rule for Camera File system) 1.0 standard; DPOF compliant

Movies: ..... AVI (Motion JPEG)

**Recording Media:** ..... 11MB built-in flash memory  
SD Memory Card  
Multimedia Card

#### Image Size

Snapshots: ..... 2304 x 1712 pixels (QV-R4)  
2240 x 1680 pixels (QV-R4)  
2048 x 1536 pixels (QV-R3)

1600 x 1200 pixels

1280 x 960 pixels

640 x 480 pixels

Movies: ..... 320 x 240 pixels

### Approximate Memory Capacity and File sizes:

#### • Snapshots

File Size (pixels)	Quality	Approximate Image File Size	Built-in flash memory 11MB	SD Memory Card* 64MB
2304 x 1712 (QV-R4)	Fine	1.8MB	5 shots	30 shots
	Normal	1.4MB	7 shots	40 shots
	Economy	1.0MB	9 shots	54 shots
2240 x 1680 (QV-R4)	Fine	1.8MB	5 shots	30 shots
	Normal	1.4MB	7 shots	40 shots
	Economy	1.0MB	9 shots	54 shots
2048 x 1536 (QV-R3)	Fine	1.6MB	6 shots	34 shots
	Normal	1.2MB	8 shots	45 shots
	Economy	630KB	15 shots	88 shots
1600 x 1200 (UXGA)	Fine	1050KB	9 shots	53 shots
	Normal	710KB	14 shots	79 shots
	Economy	370KB	27 shots	154 shots
1280 x 960 (SXGA)	Fine	680KB	14 shots	82 shots
	Normal	460KB	22 shots	126 shots
	Economy	250KB	39 shots	220 shots
640 x 480 (VGA)	Fine	190KB	52 shots	294 shots
	Normal	140KB	68 shots	386 shots
	Economy	90KB	110 shots	618 shots

## APPENDIX

### • Movies (320 x 240 pixels)

Data Size	200KB/second max.
Recording Time	One Movie: 30 seconds maximum Total Movie Time: 60 seconds maximum (built-in memory) 330 seconds maximum (SD 64MB memory card)*

\* Based on Matsushita Electric Industrial Co., Ltd. products. Capacity depends on card manufacturer.

\* To determine the number of images that can be stored on a memory card of a different capacity, multiply the capacities in the table by the appropriate value.

**Delete:** ..... Single-file, all files (with protection)

### Effective Pixels

QV-R3: ..... 3.20 million

QV-R4: ..... 4.00 million

### Imaging Element

QV-R3: ..... 1/1.8-inch square pixel color CCD  
(Total pixels: 3.34 million)

QV-R4: ..... 1/1.8-inch square pixel color CCD  
(Total pixels: 4.13 million)

### Lens/Focal Distance

QV-R3: ..... F2.6 (W) to 4.8 (T); f=7.6 (W) to 22.8mm (T) (equivalent to approximately 37 (W) to 111mm (T) for 35mm film)

QV-R4: ..... F2.6 (W) to 4.8 (T); f=7.6 (W) to 22.8mm (T) (equivalent to approximately 37.5 (W) to 112.5mm (T) for 35mm film)

**Zoom:** ..... 3X optical zoom; 3.2X digital zoom  
(9.6X in combination with optical zoom)

**Focusing:** ..... Contrast-type Auto Focus (Macro Mode, Infinity Mode); manual focus; focus lock

### Approximate Focus Range (from lens surface)

Normal: ..... 40cm to ∞ (1.3' to ∞)

Macro: ..... 14cm to 50cm (5.5" to 19.7")

Optical zoom is disabled in the Macro Mode. Zoom is fixed at maximum wide angle.

### Exposure Control

Light Metering: ..... Multi-pattern, center-weighted, spot by CCD

Exposure: ..... Program AE

Exposure Compensation: ... -2EV to +2EV (1/3EV units)

**Shutter:** ..... CCD electronic shutter; mechanical shutter, 2 to 1/2000 second

**Aperture:** ..... F2.6/5.0, auto switching

**White Balance:** ..... Automatic, fixed (4 modes), manual switching

**Self-timer:** ..... 10 seconds, 2 seconds, Triple Self-timer

### Built-in Flash

Flash Modes: ..... AUTO, ON, OFF, Red eye reduction

Flash Range: ..... Approximately 0.4 to 3.2 meters  
(1.3' to 10.5') (QV-R3)  
Approximately 0.4 to 2.8 meters  
(1.3' to 9.2') (QV-R4)

## APPENDIX

**Recording Functions:** ..... Snapshot; Best Shot; Coupling Shot; Night Scene; Manual Exposure; Movie; Interval Mode

**Monitor Screen:** ..... 1.6-inch TFT color LCD  
84,960 pixels (354 x 240)

**Viewfinder:** ..... Monitor screen and optical viewfinder

**Timekeeping Functions** .... Built-in digital quartz clock  
Date and Time: ..... Recorded with image data  
Auto Calendar: ..... To 2049

**World Time:** ..... City; Date; Time; Summer time;  
162 cities in 32 time zones

**Input/Output Terminals:** ... AC adaptor terminal (DC IN 4.5V);  
USB port (MINI-B)

## ■ Power Requirements

**Power Requirements:** ..... Rechargeable lithium ion battery (NP-30) x 1  
AC adaptor (AD-C40)

### Approximate Battery Life:

Continuous Recording	QV-R3	120 minutes (720 shots)
	QV-R4	110 minutes (660 shots)
Continuous Playback (Continuous Snapshot Recording)	QV-R3	220 minutes
	QV-R4	220 minutes

The values noted above are approximate values until power fails at normal temperature (25°C (77°F)). The above does not guarantee that you will be able to achieve this level of operation. Low temperatures shorten battery life (page 26).

**Power Consumption:** ..... DC 4.5V Approximately 5.4W

**Dimensions:** ..... 90.0(W) x 59.0(H) x 31.0(D) mm  
(3.5"(W) x 2.3"(H) x 1.2"(D))  
(excluding projections)  
Thickest Part: 35.0mm (1.4")

**Weight:** ..... Approximately 200 g (7.05 oz)  
(excluding battery and accessories)

**Bundled Accessories:** ..... Rechargeable lithium ion battery (NP-30); Special battery charger unit (BC-20); Special USB cable; Strap; CD-ROM; User's Guide

### ■ Rechargeable Lithium Ion Battery (NP-30)

**Rated Voltage:** ..... 3.7 V

**Rated Capacitance:** ..... 1000 mAh

#### Operating Temperature

**Range:** ..... 0°C to 40°C (32°F to 104°F)

**Dimensions:** ..... 35.3 (W) x 53.1 (H) x 7.1 (D) mm  
(1.4" (W) x 2.1" (H) x 0.3" (D))

**Weight:** ..... Approximately 28 g (0.99 oz)

### ■ Special battery charger unit (BC-20)

**Power Requirement:** ..... 100 to 240V AC, 0.2A, 50/60Hz

**Output:** ..... DC 4.2V, 650mA

**Charging Temperature:** ... 0°C to 40°C (32°F to 104°F)

**Chargeable Battery type:** ... CASIO Lithium-ion rechargeable battery (NP-30)

**Full Charge Times:** ..... Approximately 2 hours

**Dimensions:** ..... 65.0(W) x 90.0(H) x 30.5(D) mm  
(2.6"(W) x 3.5"(H) x 1.2"(D))  
(excluding projections)

**Weight:** ..... Approximately 120g (4.23 oz)

#### Power Supply

- Use only the special NP-30 rechargeable lithium ion battery to power this camera. Use of any other type of battery is not supported.
- This camera does not have a separate battery for the clock. The date and time settings of the camera are cleared whenever power is totally cut off (from both the battery and AC adaptor). Be sure to reconfigure these settings after power is interrupted (page 36).

#### LCD Panel

- The LCD panel is a product of the latest LCD manufacturing technology that provides a pixel yield of 99.99%. This means that less than 0.01% of the total pixels are defective (they do not turn on or always remain turned on).