

DELETING IMAGES



You can delete the currently displayed image, one or more selected images, all the images in one or more selected folders, or all the images in the camera's memory.

▶▶ IMPORTANT! ◀◀

- Image deletion cannot be undone. Before deleting an image, make sure you no longer need it or you have a back-up copy saved on your computer, on diskette, or on some other medium. Be especially careful with "Deleting All Unprotected Images" operation, which deletes all unprotected images in memory.
- A protected image cannot be deleted. See "Protecting Images Against Deletion" on page 125 for details on protecting and unprotecting images.
- Delete operations are disabled when all of the images on the camera's memory card are protected.

Deleting the Displayed Image

Use the following procedure when you want to delete the image that is currently on the monitor screen.

1. **Align the power/function switch with .**
2. **Rock the control button to the left or right, or rotate the selector dial to scroll through images and display the image you want to delete.**
3. **Press AE-L .**
4. **In response to the confirmation message that appears, rock the control button up or down to select "Yes".**
 - If you change your mind and do not want to delete the image, select "No" instead.
5. **Click the control button.**
 - Displaying a panorama or movie image in step 2 of the above procedure causes all of the images that make up the panorama or movie to be deleted.

DELETING IMAGES

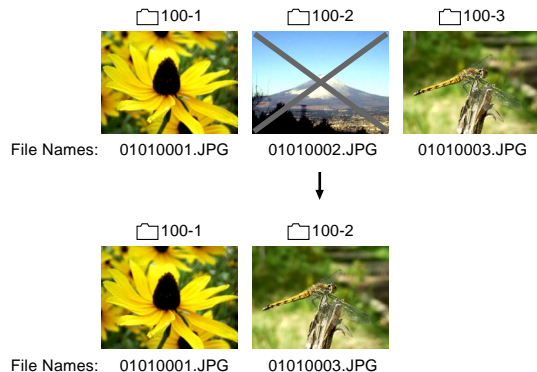

NOTE

- The camera does not maintain open spaces in its memory. Deleting an image causes images following the deleted image to be shifted up to fill in the empty space created by the deletion. Note that images are renumbered when they are shifted.



Deleting Selected Images

The following procedure lets you select one or more image for deletion.

- Align the power/function switch with .
- Press MENU.
- Select “Delete” → “Select” and then rock the control button to the right.
- Rock the control button to the left or right, or rotate the selector dial to display the image you want to delete.
- Rock the control button up or down to toggle the displayed image’s  icon on and off.

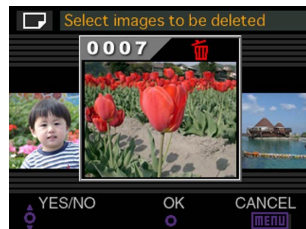

DELETING IMAGES

- Any image marked with the  icon is marked for deletion. It will be deleted when you perform the next step of this procedure.
- You can repeat steps 4 and 5 to mark and unmark multiple images if you want.

6. Click the control button.



7. In response to the confirmation message that appears, rock the control button up or down to select “Yes”.

- If you change your mind and want to cancel the delete, select “No” instead.

8. Click the control button.

Deleting All Images in Selected Folders

Use the following procedure to select one or more folder for deletion of all their images.

- 1. Align the power/function switch with .**
- 2. Press MENU.**
- 3. Select “Delete” → “Folder” and then rock the control button to the right.**
- 4. Rock the control button to the left or right, or rotate the selector dial to display the folder whose images you want to delete.**
- 5. Rock the control button up or down to toggle the displayed folder’s  icon on and off.**

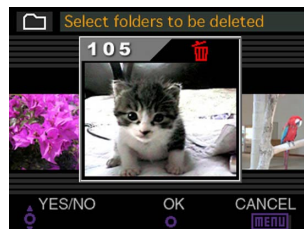

DELETING IMAGES

- Any folder with the  icon is marked for deletion. All its images will be deleted when you perform the next step of this procedure.
- You can repeat steps 4 and 5 to mark and unmark multiple folders if you want.

6. Click the control button.

7. In response to the confirmation message that appears, rock the control button up or down to select “Yes”.

- If you change your mind and want to cancel the delete, select “No” instead.

8. Click the control button.

Deleting All Unprotected Images

Use the following procedure when you want to delete all of the images currently on the camera’s memory card.

1. Align the power/function switch with .

2. Press MENU.

3. Select “Delete” → “All” and then rock the control button to the right.

4. In response to the confirmation message that appears, rock the control button up or down to select “Yes”.

- If you change your mind and want to cancel the delete, select “No” instead.

5. Click the control button.

MANAGING IMAGES

The image management capabilities of the camera make it easy to keep track of images. You can protect images against deletion, and even use its DPOF feature to specify images for printing.

Folders and Files

When you shoot the first image on a particular day, the camera automatically creates a folder for that date. All subsequent images you shoot on that day are stored in the same folder.

- For full details about the organization of folders on the memory card, see “Using a Memory Card to Transfer Image Data” on page 149.

Folders

A folder is created automatically whenever you shoot the first image on a particular date. The name assigned to the folder is based on the current date, as described below. You can have up to 900 folders on a memory card at the same time (subject to storage capacity restrictions).

Example: Folder created on July 19, which is the 100th folder on the memory card

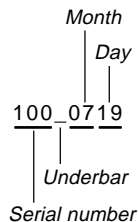

- The actual number of files you will be able to store on a memory card depends on the capacity of the card, image quality settings, etc.

Files

Each folder can contain up to 250 image files. If you try to save the 251st image to a folder, the camera automatically creates a new folder and stores the image there. The names assigned to files are based on the current date, as shown below.

Example: 26th image shot on November 7



- In addition to image files, memory card also contains a number of other files used by the system for image data management.
- The actual number of files you will be able to store on a memory card depends on the capacity of the card, image quality settings, etc.
- Panorama images are stored as groups of multiple individual images.
- If there are more than 250 image files in a folder (due to copying from another digital camera or other source), only the first 250 (in name sequence) can be played back.

Protecting Images Against Deletion



Image protection guards against accidental deletion of images stored on the camera's memory card. A protected image cannot be deleted until it is unprotected (page 119). You can protect and unprotect a single specific image, all the images in a particular folder, or all images currently on the memory card.

Protecting Selected Images



1. Align the power/function switch with .
2. Press MENU.
3. Select "Protect" → "Select" and then rock the control button to the right.
4. Rock the control button to the left or right, or rotate the selector dial to display the image you want to protect.

5. Rock the control button up or down to toggle the displayed image's  icon on and off.





- Any image marked with the  icon is marked for protection. It will be protected when you perform the next step of this procedure. Any image without the  icon will be unprotected.
 - You can repeat steps 4 and 5 to turn on the  icon for multiple images if you want.
6. Click the control button to protect all the images marked for protection, and unprotect the unmarked images.

Protecting and Unprotecting All Images in Selected Folders

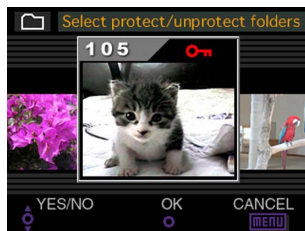
1. Align the power/function switch with .
2. Press MENU.
3. Select “Protect” → “Folder” and then rock the control button to the right.
4. Rock the control button to the left or right, or rotate the selector dial to display the folder whose images you want to protect.
5. Rock the control button up or down to toggle the displayed folder’s  icon on and off.



- Any folder with the  icon is marked for protection. All its images will be protected when you perform the next step of this procedure. All images in any folder without the  icon will be unprotected.
 - You can repeat steps 4 and 5 to turn on the  icon for multiple folders if you want.
6. Click the control button to protect the images in all the folders marked for protection, and unprotect the images in the unmarked folders.

Protecting and Unprotecting All Images

1. Align the power/function switch with .
2. Press MENU.
3. Select “Protect” → “All” and then rock the control button to the right.
4. Select the memory protection setting you want, and then click the control button to apply it.

To do this:	Select this:
Protect all images on the memory card	On
Unprotect all images on the memory card	Off

DPOF

The letters “DPOF” stand for “Digital Print Order Format”, which is a format for recording on a memory card or other medium which digital camera images should be printed and how many copies of the image should be printed. Then you can print on a DPOF-compatible printer or at a professional print service from the memory card in accordance with the file name and number of copies settings recorded on the card.

With this camera, you should always select images by viewing them on the monitor screen. Do not specify images by file name without viewing the file contents.



■ DPOF Settings

File name, number of copies, date

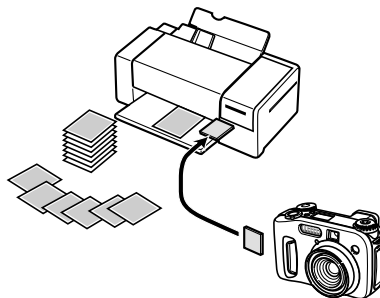



Making DPOF Settings for Particular Images

1. Align the power/function switch with .
2. Press MENU.
3. Select “DPOF” → “Select” and then rock the control button to the right.
4. Rock the control button to the left or right, or rotate the selector dial to display the image you want to print.
5. Use the button operations described below to make the DPOF settings you want.



If you want to do this:	Do this:
Decrease the number of copies value	Rock the control button down.
Increase the number of copies value	Rock the control button up.
Toggle printing of the recording date on and off	Press DISP.

- Note that some printers may not support recording date printing.
 - An image selected for printing is marked by the  icon.
 - An image for which printing of the recording date is turned on is marked with the  icon.
 - You can repeat steps 4 and 5 to make DPOF settings for multiple image files, if you want.
6. After you are finished making the settings you want, click the control button to complete the procedure.

Making DPOF Settings for Particular Folders

1. Align the power/function switch with .
2. Press MENU.
3. Select “DPOF” → “Folder” and then rock the control button to the right.
4. Rock the control button to the left or right, or rotate the selector dial to display the folder whose images you want to print.
5. Use the same procedures as those described in step 5 under “Making DPOF Settings for Particular Images” on page 128 to make the DPOF settings you want.
6. After you are finished making the settings you want, click the control button to complete the procedure.

Making DPOF Settings of All Images on the Memory Card

1. Align the power/function switch with .
2. Press MENU.
3. Select “DPOF” → “All” and then rock the control button to the right.
4. Select “Set print order” and then rock the control button to the right.
 - To cancel printing, select “Cancel print order”.
5. Use the button operations described below to make the DPOF settings you want.

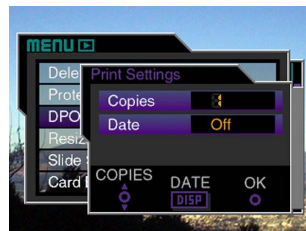

If you want to do this:	Do this:
Decrease the number of copies value	Rock the control button down.
Increase the number of copies value	Rock the control button up.
Toggle printing of recording dates on and off	Press DISP.

- Note that some printers may not support recording date printing.

6. After you are finished making the settings you want, click the control button to complete the procedure.

PRINT Image Matching II

Images include PRINT Image Matching II data (mode setting and other camera setup information). A printer that supports PRINT Image Matching II reads this data and adjusts the printed image accordingly, so your images come out just the way you intended when you recorded them.

* PRINT Image Matching and PRINT Image Matching II are registered trademarks of SEIKO EPSON Corporation.



Exif Print

Exif Print is an internationally supported, open standard file format that makes it possible to capture and display vibrant digital images with accurate colors. With Exif 2.2, files include a wide range of shooting condition information that can be interpreted by an Exif Print printer to produce better-looking prints.

The logo for Exif Print features the words "Exif Print" in a bold, italicized, sans-serif font. Above the text is a decorative arc of seven small, dark dots, resembling a film strip or a stylized smile.

»» IMPORTANT! ««

- Information about the availability of Exif Print compatible printer models can be obtained from each printer manufacturer.



OTHER SETTINGS

Changing the Menu Language

When you first purchase your camera, it comes with a set of three different menu languages from which you can choose. The bundled CD-ROM contains additional menu language sets that you can install if you want. In all, you get a total choice of six different languages (English, German, French, Spanish, Italian and Japanese).

▶▶ IMPORTANT! ◀◀

- You can have only one 3-language set installed on the camera at a time.

1. Align the power/function switch with  or .
2. Press MENU.
3. Select “Language” and then rock the control button to the right.
4. Select the language you want, and then click the control button to apply it.
 - This displays the language selection menu.
 - The following shows the settings for all six of the available languages.

To do this:	Select this setting:
Display menus in English	English
Display menus in German	Deutsch
Display menus in French	Français
Display menus in Spanish	Español
Display menus in Italian	Italiano
Display menus in Japanese	日本語

5. Press MENU to exit the setting procedure.

Installing a Different Language Set

The CD-ROM that comes bundled with the camera contains two menu text language files, each of which contains a set of three different languages. You can copy the file that contains the language set you want to a memory card and then install it on the camera.

- The following three language sets of menu data are available on the CD-ROM.

Language Set	File Name
English, German, French	menu_egf.bin
Spanish, Italian, Japanese	menu_sij.bin

■ Transferring Menu Language Data to a Memory Card

The procedure you should use to transfer a language set file to a memory card depends on whether you have a Windows or a Macintosh computer.

● Windows

▶▶ IMPORTANT! ◀◀

- Depending on the operating system you are running, you may need to install the USB driver if you are connecting the camera to your computer for the first time. See page 147 for more information.

1. Set the bundled CD-ROM into your computer's CD-ROM drive.

- This displays the CD-ROM menu.
- If you have auto run turned off for your CD-ROM drive, start up the CD-ROM menu by double-clicking "My Computer" and then the CD-ROM volume named CASIO.

2. Connect the camera to your computer using the USB cable (page 147).

- Use the USB cable that comes bundled with the camera.

- You can also access the memory card directly from your computer without connecting to the camera. See page 149 for more information.

3. On the CD-ROM menu that appears on your computer screen, select "🗂 Language".

4. Select the language set you want to use.

5. Click OK.

- This opens a separate window for the folder that contains the camera menu language file you selected.

6. Select "Open camera".

- This opens a window for the memory card root directory.

7. Click OK.

8. Copy the "menu_***.bin" file from the window that opened in step 5 to the window that opened in step 7.

9. Disconnect the USB cable connecting the camera to your computer (page 149).

- If you accessed the memory card directly with your computer, use the required procedure to eject the memory card.

● Macintosh

1. Set the bundled CD-ROM into your Macintosh's CD-ROM drive.
2. Connect the camera to your Macintosh using the USB cable (page 147).
 - Use the USB cable that comes bundled with the camera.
 - You can also access the memory card directly from your Macintosh without connecting to the camera. See page 149 for more information.
3. Open the CD-ROM volume named "CASIO".
4. Open the "Camera Language" folder.
5. Open the folder that contains the language set you want to use.
6. Open the camera memory card displayed (mounted) on your Macintosh screen.

7. Copy the "menu_***.bin" file from the folder you opened in step 4 to the folder you opened in step 5.

8. Disconnect the USB cable connecting the camera to your Macintosh (page 149).

- If you accessed the memory card directly with your Macintosh, use the required procedure to eject the memory card.



■ Loading Menu Language Data into the Camera

▶▶ IMPORTANT! ◀◀

- If power to the camera is cut off while you are loading menu language data, the camera's program will not be able to run correctly and you will need to take your camera in for repair before you can use it again. Because of this you must observe the following precautions whenever performing the procedure below.
 - Use the AC adaptor to power the camera or load a new set of recommended batteries into the camera.
 - Never touch the camera while the menu language data is being loaded.

1. Insert the memory card you created using one of the procedures under “Transferring Menu Language Data to a Memory Card” on page 133 into the camera.

2. Hold down MENU as you turn on the camera.

- To turn on the camera, align the power/function switch with  or .





- The above screen does not appear if you are running on battery power and your batteries are too low. The normal camera display screen appears instead. If this happens, switch to AC adaptor power or load a new set of recommended batteries into the camera.
- If the camera has multiple menu language data files installed, you can rock the control button up or down to select a data file.

3. Press the shutter release button.

- The message “NOW LOADING” appears on the monitor screen, indicating that menu language data is being loaded.
- The message “COMPLETE!” appears when the menu data loading procedure is complete. After about four seconds, the monitor screen changes to the normal camera display.

Turning the Confirmation Beep On and Off

Use the following procedure to turn the beep that sounds each time you press a button on and off.

1. Align the power/function switch with  or .
2. Press MENU.
3. Select “Beep” and then rock the control button to the right.
4. Select the setting you want, and then click the control button to apply it.

To do this:	Select this setting:
Turn on the confirmation beep	On
Turn off the confirmation beep	Off

5. Press MENU to exit the setting procedure.

CONNECTING TO EXTERNAL EQUIPMENT

Your camera has three terminals for connection to external equipment: a VIDEO OUT terminal, a DIGITAL terminal (remote shutter release terminal), and a USB port. You can use these terminals to connect the camera to a television, VCR, computer, or other external equipment. See page 103 for information about the DIGITAL port (remote shutter release terminal).

▶▶ IMPORTANT! ◀◀

- Be sure to turn off both the camera and the other equipment before making any connections.
- Check the documentation that comes with your other equipment for information you may need to know when making connections.
- Leaving the same image displayed on a television or computer display screen for very long periods can cause the image to be “burned in” on the screen. When this happens, a faint after-image remains on the screen, even after you disconnect the camera. To avoid this, you should not leave the same image displayed on such a screen for very long periods.
- This camera does not support cable transfer of data with other CASIO digital cameras, portable telephones, etc.

Connecting to a Television

Images being displayed on the camera’s monitor screen, whether for recording or playback, can also be displayed on the screen of a connected television. Connect the camera to a TV as illustrated below.

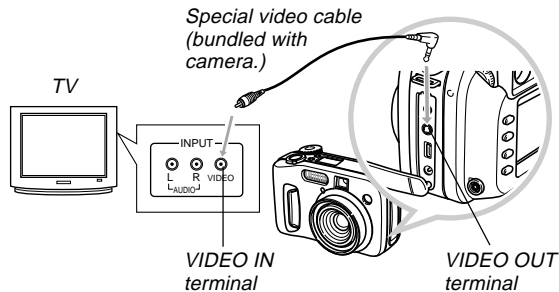

1. Use the video cable to connect the camera to the television as shown in the illustration.
2. Perform the required operation on the TV to set it up for video input.
 - See the documentation that comes with your television for information about how to do this.
3. Perform normal playback and recording operations on the camera.

▶▶ IMPORTANT! ◀◀



- Icons and other indicators that normally appear on the camera's monitor screen will also appear on the screen of the connected TV.

Selecting the Video Output Signal Mode

Your camera supports both NTSC (used in U.S., Japan, and other countries) and PAL (used in Europe and other areas) video output signal systems. The video system you should use depends on the country of origin of the equipment you are connecting to the camera's VIDEO OUT terminal.

▶▶ IMPORTANT! ◀◀

- When you have PAL selected as the video signal output mode, the monitor screen is turned off when you connect the cable to the VIDEO OUT terminal.

1. Align the power/function switch with  or .
2. Press MENU.
3. Select "Video Out" and then rock the control button to the right.
4. Select "NTSC" or "PAL" and then click the control button to apply it.
5. Press MENU to exit the setting procedure.

Connecting to a Computer

The USB cable that comes with your camera makes it easy to connect to a computer that is equipped with a USB port. You can also transfer images using the memory card, if your computer is equipped to read memory cards.

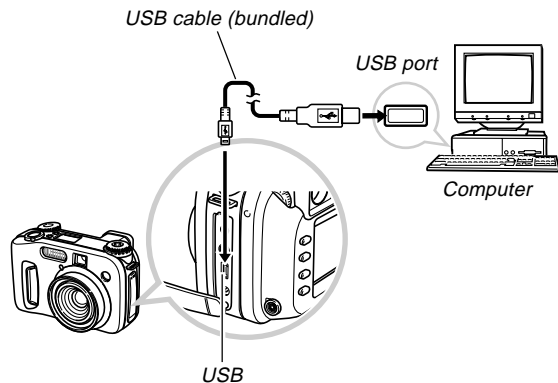

Installing the Software from the CD-ROM

Before you can exchange files with your computer, you first need to install the software contained on the CD-ROM that comes with the camera.

About the bundled CD-ROM

The CD-ROM that comes bundled with the camera contains the following software.

Photo Loader (for Windows/Macintosh)

This application loads image data saved in JPEG and AVI format from a digital camera onto your computer.

Photohands (for Windows)

This application is for retouching and printing image files.

Panorama Editor (for Windows)

This application creates and plays back panorama images by editing image data.

USB Driver for Mass Storage (for Windows/Macintosh)

This is the software that makes it possible for the camera to “talk” to your personal computer over a USB connection. If you are using Windows XP, Mac OS 9, or Mac OS X, do not install the USB driver from the CD-ROM. With these operating systems, you will be able to perform USB communication simply by connecting the camera to your computer with the USB cable.

Internet Explorer (for Macintosh)

This is a browser application for reading HTML files. Images loaded by Photo Loader are stored in folders called “Libraries.” Internet Explorer displays the contents of a library on your computer screen.

DirectX (for Windows)

This software provides an extended tool set including a codec that allows Windows 98 and 2000 to handle movie files recorded using a digital camera. You do not need to install DirectX if you are running Windows XP or Me.

Acrobat Reader (for Windows/Macintosh)

This is an application that lets you read PDF files. Use it to read the user documentation for the camera, Photo Loader, Photohands and Panorama Editor all of which is included on the bundled CD-ROM.

NOTE

- See the user documentation files (PDF) on the bundled CD-ROM for details about using Photo Loader and Photohands. See “Viewing User Documentation (PDF files)” on page 143 (Windows) and page 146 (Macintosh) of this manual for more information.

Computer System Requirements

Computer system requirements depend on each of the applications, as described below.

Windows

See the “Readme” file on the bundled CD-ROM.

Macintosh

See the “readme” file on the bundled CD-ROM.

Installing Software from the CD-ROM in Windows

Use the procedures in this section to install the software from the bundled CD-ROM to your computer.

NOTE

- You do not need to install software if you already have it installed on your computer.

The CD-ROM includes the software and user documentation for various languages. Check the CD-ROM menu screen to see if applications and user documentation are available for a particular language.

Getting Started

Start up your computer and insert the CD-ROM into its CD-ROM drive. This will automatically launch the menu application, which displays a menu screen on your computer.



NOTE

- The menu application may not start up automatically on some computers. If this happens, navigate to the CD-ROM and double-click “menu.exe” to launch the menu application.

Selecting a Language

First select a language. Note that some software is not available in all languages.

- On the menu screen, click the language button in the upper left corner of the display.
- On the list of languages that appears, select the one you want.

■ Viewing the Contents of the “Read me” File

You should always read the “Read me” file for any application before installing it. The “Read me” file contains information you need to know when installing the application.

1. On the menu screen, click “Software.”
2. Click the name of the application you want to install.
3. Click the “Read me” button.

▶▶ IMPORTANT! ◀◀

- Before upgrading or reinstalling Photo Loader, or before installing it onto another computer, be sure to read the “Read me” file for information about retaining existing libraries.

■ Installing an Application

1. On the menu screen, click “Software.”
2. Click the name of the application you want to install.
3. Click the “Install” button.
4. Follow the instructions that appear on your computer screen.

▶▶ IMPORTANT! ◀◀

- Be sure to follow the instructions carefully and completely. If you make a mistake when installing Photo Loader, you may not be able to browse your existing library information and HTML files that are created automatically by Photo Loader. In some cases, image files may be lost.
- When using an operating system other than Windows XP, never connect the camera to your computer without installing the USB driver from the CD-ROM first.

■ Viewing User Documentation (PDF Files)

1. On the menu screen, click “Manual.”
2. Click the name of the application whose user documentation you want to read.
3. Click the “Read” button.

▶▶ IMPORTANT! ◀◀

- You need to have Adobe Acrobat Reader installed on your computer to read user documentation files. If you do not already have Adobe Acrobat Reader installed, you can install it from the bundled CD-ROM.

■ Exiting the Menu Application

1. On the menu screen, click “Exit” to exit the menu.

Installing Software from the CD-ROM on a Macintosh

The CD-ROM contains applications and user documentation in various languages in folders named for each language: English, French, German, Spanish, Italian, Dutch, and Chinese. Check the CD-ROM folders to find out if applications and user documentation are available in a particular language.

File names include one of the following codes that indicate the language of the data contained in the file as shown below.

English: e, French: f, German: g, Spanish: sp, Italian: i, Dutch: du, Chinese: ct

If your language is not included in the above, use the contents of the “English” folder.

Installing Software

Use the following procedures to install the software. We recommend that you install Internet Explorer and Outlook Express first before installing Photo Loader and Acrobat Reader.

● To install Internet Explorer and Outlook Express

1. Open the file named “Internet Explorer.”
2. Open the folder for the language version you want to install, and then open the file named “readme_casio” file.
3. Follow the instructions in the read me file to install Internet Explorer and Outlook Express.

● To install Photo Loader

1. Open the folder named “Photo Loader.”
2. Open the folder named “English,” and then open the file named “Important.”
3. Open the folder named “Installer,” and then open the file named “readme.”
4. Follow the instructions in the “readme” file to install Photo Loader.

▶▶ IMPORTANT! ◀◀

- If you are upgrading to the new version of Photo Loader from a previous version and you want to use library management data and HTML files created using the old version of Photo Loader, be sure to read the “Important” file in the “Photo Loader” folder. Follow the instructions in the file to use your existing library management files. Failure to follow this procedure correctly can result in loss or corruption of your existing files.

● To install Acrobat Reader

1. On the bundled CD-ROM, open the folder named “Acrobat Reader.”
2. Open the folder for the language whose version of Acrobat Reader you want to install, and then open the file named “readme_casio.”
 - Follow the instructions in the read me file to install Acrobat Reader.

● Installing the USB Driver

1. Turn off the camera and quit all applications on your Macintosh.
2. Insert the bundled CD-ROM provided into the CD-ROM drive.
3. Open the hard disk that is specified as the startup disk.
4. Open the “System Folder” on the startup disk.
5. Open the “Extensions” folder inside the “System Folder.”
6. Open the “USB Driver” folder on the CD-ROM.
7. Drag “CASIO-USB Storage Driver” and “CASIO-USB Storage Class Shim” from the “USB Driver” folder to the “Extensions” folder.
8. Confirm that the “CASIO-USB Storage Driver” file and “CASIO-USB Storage Class Shim” file are in the “Extensions” folder, and then restart your Macintosh.

9. After the system starts up, use the USB cable to connect the camera to your Macintosh.

10. Turn on the camera.

11. From now on, the camera will be recognized as a drive whenever you connect the camera to your Macintosh.

- The shape of the icon that appears on your Macintosh display depends on the version of your Mac OS.



»» IMPORTANT! ««

- If you are running an operating system other than Mac OS 9 or Mac OS X, do not connect the camera to your Macintosh PC without installing the USB driver first.
- **To uninstall the USB driver**
Delete “CASIO-USB Storage Driver” and “CASIO-USB Storage Class Shim” from the “Extensions” folder.

■ Viewing User Documentation (PDF Files)

To perform the following procedures, you must have Acrobat Reader installed on your Macintosh (page 144).

1. On the bundled CD-ROM, open the folder named “Acrobat Reader.”
2. Open the folder for the language whose version of Acrobat Reader you want to install, and then open the file named “readme_casio.”
3. Follow the instructions in the read me file to install Acrobat Reader.

● To view the camera user’s guide

1. On the CD-ROM, open the “Manual” folder.
2. Open the “Digital Camera” folder, and then open the folder for the language whose user’s guide you want to view.
3. Open the file named “camera_xx.pdf.”
4. “xx” is the language code (English: e, French: f, German: g, Spanish: sp, Italian: i, Dutch: du, Chinese: ct).

● To read the Photo Loader user’s guide

1. On the CD-ROM, open the “Manual” folder.
2. Open the “Photo Loader” folder and then open the “English” folder.
3. Open “PhotoLoader_english.”

Transferring Files to a Computer

The CD-ROM that comes bundled with your camera contains a copy of Photo Loader and a USB driver. This software lets you transfer the contents of the camera's memory to your computer quickly and easily. The Photo Loader and Photohands applications can also be used for high-level image management and editing.

- For information about using Photo Loader and Photohands, see their user documentation files (PDF) on the bundled CD-ROM.

■ Transferring Files Over a USB Connection

You can transfer images to a computer with a USB port simply by connecting the camera to the computer with the USB cable.

- Note that you need to install a USB driver on your computer the first time you try to connect. Once you use the cable to establish a USB connection, the computer sees the camera as an external storage device (card reader/writer).
- If you plan to transfer file data from the camera's built-in memory to your computer, make sure there is no memory card loaded in the camera. If there is, remove the memory card from the camera before you connect the USB cable.

»» NOTE ««

- Do not install the USB driver from the CD-ROM onto a computer running Windows XP, Mac OS 9, or Mac OS X. With these operating systems, USB communication becomes enabled simply by connecting the camera to the computer with the USB cable.

CONNECTING TO EXTERNAL EQUIPMENT

● To connect the USB Cable

1. Turn on the camera.
2. Open the terminal panel cover and then use the USB cable to connect the camera to the computer.

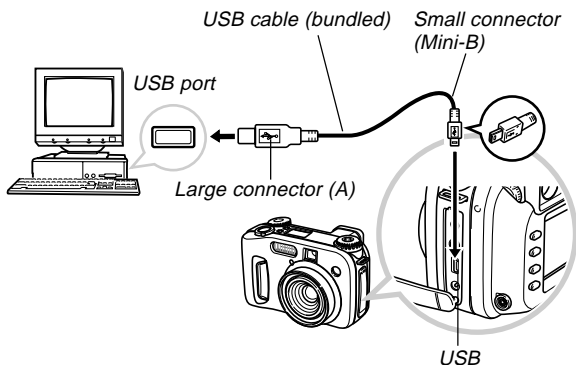

3. Import the images to the computer.
4. After image data transfer is complete, disconnect the USB cable.
 - For details, see "Terminating a USB Connection."

▶▶ IMPORTANT! ◀◀

- Be sure to read the applicable information in the user documentation that comes with your computer before connecting the USB cable.
- Do not leave the same image displayed on your computer screen for a long time. Doing so can cause the image to "burn in" on the screen.
- Take care when connecting the USB cable to the camera. The USB port and the cable plug are shaped for proper positioning.
- Plug the USB cable into the ports securely as far as it will go. Proper operation is not possible if connections are not correct.
- The camera does not draw power over the USB cable. Be sure to connect the AC adaptor to the camera for power.
- The optionally available CASIO QC-1U USB cable cannot be used with this camera.
- Never disconnect the USB cable while the PC is accessing camera memory (indicated by a flashing USB lamp). Doing so can cause data to become corrupted.
- You can perform USB data communication while the camera is in a recording mode or in the Play Mode.

● Terminating a USB Connection

Windows Me or 98

Disconnect the USB cable from the camera, and then turn off the camera.

Windows XP or 2000

Click card services in the task tray on your computer screen, and disable the drive number assigned to the camera. Next, disconnect the USB cable from the camera, and then turn off the camera.

Macintosh

In Finder, drag the camera to the trashcan. Next, disconnect the USB cable from the camera and then turn off the camera.

Using a Memory Card to Transfer Image Data

In addition to the cable connections described in the previous sections, you can also exchange data between your camera and computer by reading it directly from the memory card. The Photo Loader software that comes on the bundled CD-ROM automatically reads the images from the memory card and stores them in folders on your computer's hard disk.

The following provides general information about how to directly read images from a memory card. Certain details may be different depending on the type of computer you are using.

■ **Computer Equipped with a CompactFlash Card Slot**

Simply insert the memory card into your computer's CompactFlash card slot.

CONNECTING TO EXTERNAL EQUIPMENT

■ Computer Equipped with a PC Card Slot

For this configuration, you will need to purchase a separately available CASIO PC Card Adapter (CA-10). See the instructions that come with the PC Card Adapter for information about how to use it.

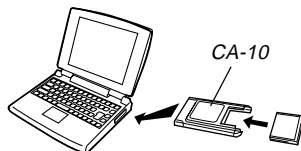

■ Another Computer

To access the contents on the memory card on a computer that does not have a CompactFlash card slot or PC card slot, use a commercially available PC card reader/writer in combination with a separately available CASIO PC Card Adapter (CA-10). See the instructions that come with the PC card reader/writer and the PC Card Adapter for information about how to use them.

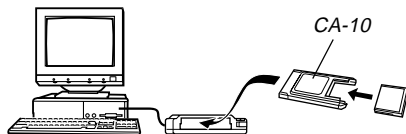

Memory Card Data

Images recorded with this camera and other data is stored on the memory card using DCF (Design rule for Camera File system) protocol. DCF protocol is designed to make it easier to exchange image and other data between digital cameras and other devices.

DCF Protocol

DCF devices (digital cameras, printers, etc.) can exchange images with each other. DCF protocol defines the format for image file data and the directory structure for the memory card, so images can be viewed using another manufacturer's DCF camera or printed on a DCF printer. In addition to support for the DCF protocol, your CASIO digital camera also uses dates in image folder names and image file names, which helps to make data management easier.

Memory Card File Structure

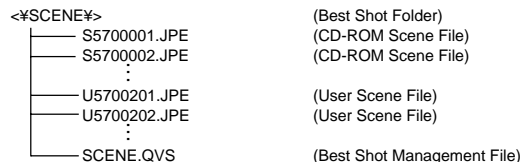
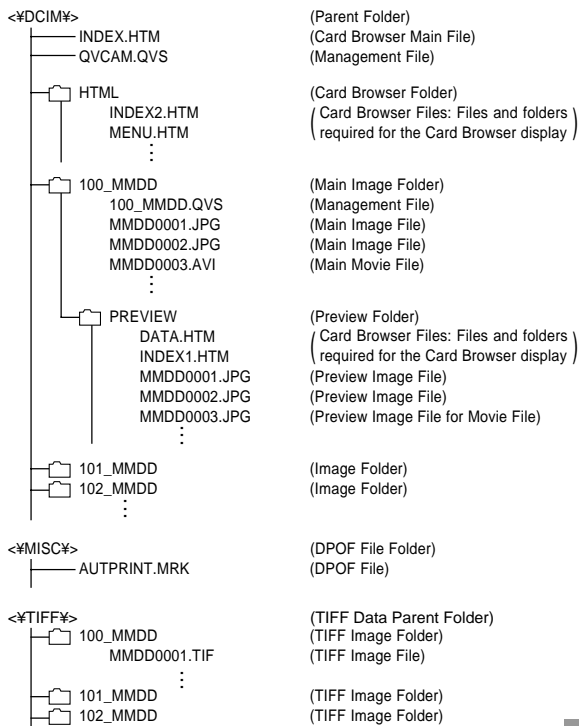

Folder and File Contents

- Parent Folder
Contents: All files used by the digital camera
- Card Browser Main File
Contents: Template for card browser, which is used for viewing image previews with a web browser
- Management File
Contents: Information about folder management, image sequence, etc.
- Card Browser Folder
Contents: Files used by the card browser
- Card Browser File
Contents: Data used by the card browser
- Main Image Folder
Contents: Image files recorded by the camera

CONNECTING TO EXTERNAL EQUIPMENT

- Main Image File
Contents: Still image file recorded by the camera
- Main Movie File
Contents: Movie file recorded by the camera
- Preview Folder
Contents: Preview images (hidden file)
- Preview Image File
Contents: Preview images of still image and movie files used for temporary playback and card browser previews
- DPOF File Folder
Contents: DPOF files
- TIFF Data Parent Folder
Contents: All TIFF format image related files
- TIFF Image Folder
Contents: TIFF format image files
- TIFF Image File
Contents: TIFF format image file
- Best Shot Folder
Contents: Scene files copied from the CD-ROM
- CD-ROM Scene Files/User Scene Files*
Contents: Best Shot Mode files

NOTES

- A memory card's actual file structure may differ somewhat in accordance with the type of Card Browser you are using (page 154).
- Folders and files marked with an asterisk are created when required by their associated functions.

Image Files Supported by the Camera

- Image files recorded with the CASIO QV-5700 Digital Camera
- DCF protocol image files

Certain DCF functions may not be supported.

Precautions when Using a Memory Card on a Computer

- This camera uses management files to manage the sequence and attributes of image files. Because of this, if you use your computer to modify or delete memory card files, to change management file contents, or to change image file sequence and attributes and then transfer the images back to the camera, you may end up with the wrong image sequence, ungrouped panorama images, and slow image scrolling.
- Note that the folder named “DCIM” is the parent (top) folder of all the files on a memory card. When transferring memory card contents to a hard disk, floppy diskette, MO disk, or other external storage, treat all the contents inside a DCIM folder as a set and always keep them together. Also, never use your computer to edit or delete the management files (those whose file names have the extension QVS) inside a DCIM folder. You can change the name of the DCIM folder on your computer. Changing the name to a date is a good way to keep track of multiple DCIM folders. However, be sure you change the name of the DCIM folder back to “DCIM” before you copy it back to a memory card for playback on the camera. The camera does not recognize any folder name other than DCIM.

- The above is also true about the names of folders inside the DCIM folder. These folders must be returned to the names assigned to them by the camera whenever you copy the folder back to the memory card for playback on the camera.
- We also strongly recommend that after transferring data from a memory card to other external storage you re-format the memory card and delete its contents before using it to record more images.
- The camera formats memory cards using ATA format, which means that a Macintosh sees all memory card files as text files. To view memory card files on a Macintosh, use PC Exchange to associate the files on the memory card (which are .JPG, .JPE, or .TIF files) with an application that is able to open JPEG/TIFF files.

Using the HTML Card Browser



The camera's Card Browser generates HTML files that let you see a table of image thumbnails for easy selection. You can also view the properties of each image.

- Card Browser files can be viewed using the Web browsers listed below. Quick Time is required to view movie files on a computer running Windows 2000 or 98.

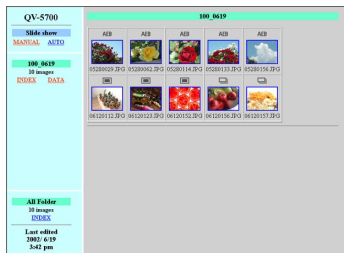
Microsoft Internet Explorer 4.01 or later
Netscape Communicator 4.5 or later



Specifying the Card Browser Type

1. Align the power/function switch with  or .
2. Press MENU.
3. Select “Card Browser” and then rock the control button to the right.
4. Select the Card Browser setting you want.

When you want this:	Select this:
To turn off the Card Browser (no HTML files generated)	Off
Maximum performance, including access to image properties and slideshow capabilities	Type1
Light image viewing with access to image properties	Type2
Basic image viewing with slideshow capabilities	Type3
Basic image viewing	Type4

5. Click the control button to apply it.

- When you turn on any Card Browser (Type 1 through 4), the camera creates a file named "INDEX.HTM" inside the DCIM folder whenever you turn off camera power. Other files are also created and stored on the memory card at this time.

6. Press MENU to exit the setting procedure.

»» NOTE ««

- The amount of time it takes for the camera to power down depends on the number of files on its memory card. If your card has a large number of files, we recommend that you normally leave the Card Browser turned off if you do not need to use it. The power down routine performed by the camera is much shorter when the Card Browser is turned off.

»» IMPORTANT! ««

- When the Card Browser is turned on, turning off camera causes the monitor screen goes blank, but the operation/card access lamp continues to flash for some time as the camera internally creates Card Browser files. Never perform any of the operations listed below while the operation/card access lamp is flashing. Doing so not only stops creation of Card Browser files, it can also result in corruption of the image data on the memory card.
 - Opening the memory card slot cover
 - Unplugging the AC adaptor
 - Opening the battery compartment cover
 - Other actions similar to those above
- Note that Card Browser files may be corrupted if batteries go low or if the memory card becomes full during file generation.
- You can specify the language for the Card Browser's on-screen text using the procedure under "Changing the Menu Language" (page 132).

Viewing Card Browser File Contents

Use your computer's Web Browser to view the contents of the Card Browser files.

1. Transfer the image data from the camera to your computer by cable (page 147) or by accessing the memory card from your computer (page 149).
2. On the memory card, open the folder named "DCIM".

3. Use your Web browser to open the file named "INDEX.HTM".

- This displays a gallery of thumbnails for all the images contained in the oldest image folder on the memory card.

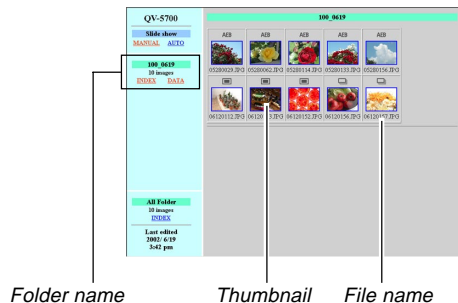

4. You can click the following items on the screen to perform the operations described below.

To do this:	Click here:
Start an automatic slideshow of full-screen size images (5-second interval)	AUTO
Start a manual slideshow of full-screen size images (image changes with click)	MANUAL

- Tapping an image on the INDEX screen or DATA screen displays a 640 x 480-pixel version of the image. Clicking the full-screen images displays the image in the size at which it was recorded.

▶▶ IMPORTANT! ◀◀

- Slideshow images are displayed in full-screen size, regardless of the size at which they were recorded.
- The thumbnail gallery uses the contents of the Preview Folder (page 151). Images copied from another digital camera or a computer do not have preview images associated with them, so their thumbnails do not appear initially in the thumbnail gallery. If this happens, scroll through the images on the camera's monitor screen until the copied image appears. At this time, the camera automatically generates a preview image, which will now appear in the Card Browser thumbnail gallery.

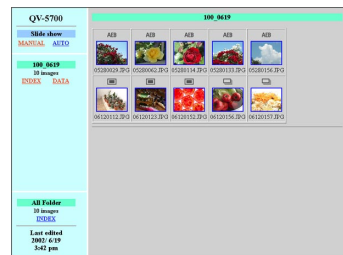

INDEX

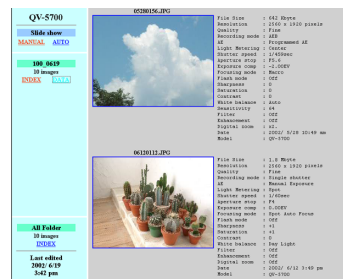

DATA

- Image Properties

The following is the information provided by the Image Properties screen.

File Size	: File size
Resolution	: Resolution
Quality	: Quality
Drive mode	: Drive mode
AE	: Exposure mode
Light metering	: Metering mode
Shutter speed	: Shutter speed
Aperture stop	: Aperture stop
Exposure comp	: Exposure compensation
Focusing mode	: Focusing mode
Flash mode	: Flash mode
Sharpness	: Sharpness
Saturation	: Saturation
Contrast	: Contrast
White balance	: White balance
Sensitivity	: Sensitivity
Filter	: Filter setting
Enhancement	: Enhancement setting
Flash intensity	: Flash intensity
Digital zoom	: Digital zoom setting
Date	: Recording date and time
Model	: Camera model name

5. To exit the Card Browser, simply quit your Web browser.

Saving Card Browser Files

- To save Card Browser files, use a USB cable connection (page 147) or memory card transfer (page 149) to copy the folder named “DCIM” on the memory card to a hard disk, floppy diskette, MO disk, or other external storage. Never use your computer to edit or delete files, to add new images, or to delete images. Doing so will make it impossible to view images normally using the Card Browser.
- You can use the Photo Loader application contained on the bundled CD-ROM disc to save Card Browser files. See the documentation that comes with Photo Loader on the CD-ROM for full details.
- We also strongly recommend that after transferring data from a memory card to other external storage that you reformat the memory card and delete its contents before using it to record more images.

REFERENCE

Camera Menus

The following shows lists of menus that appear in the REC mode and PLAY mode, and their settings.

- The settings that are underlined in the following table are initial defaults.

REC mode

Menu	Available Settings	
Size	<u>2560x1920</u> / 2544x1696 (3:2) / 1600x1200 / 1280x960 / 640x480	
Quality	<u>Fine</u> / Normal / Economy / TIFF	
Sensitivity	Auto / <u>0</u> (ISO 50) / +1 (ISO 100) / +2 (ISO 200) / +3 (ISO 400) / +4 (ISO 800)	
Enhancement	<u>Off</u> / Red / Green / Blue / Flesh Tones	
Filter	<u>Off</u> / B/W / Sepia / Red / Green / Blue / Yellow / Pink / Purple	
Saturation	+2 / +1 / <u>0</u> / -1 / -2	
Contrast	+2 / +1 / <u>0</u> / -1 / -2	
Sharpness	+2 / +1 / <u>0</u> / -1 / -2	
AEB Setting	EV Shift	<u>1/3</u> / 1/2 / 2/3 / 1
	Number of Exposures	<u>3 Frames</u> / 5 Frames
Flash Setting	<u>Front-curtain Flashsync</u> / Rear-curtain Flashsync	

Flash Intensity	Strong / <u>Normal</u> / Weak	
Sync Speed	Fast / <u>Normal</u> / Slow	
Digital Zoom	<u>Off</u> / <u>On</u>	
Focus Expansion	<u>Off</u> / On	
Grid	<u>Off</u> / On	
BestShot Setting	<u>Built-in+CF</u> / Built-in / CF	
Release Setting	<u>Off</u> /On	
Time Stamp	<u>Off</u>	
	Year/Month/Day	
	Day Hour : Minutes	
Power Save	Year/Month/Day Hour : Minutes	
	Sleep	Off / 30sec / <u>1min</u> / 2min
	Auto Power Off	<u>2min</u> / 5min
Mode Memory	Flash	<u>Off</u> / <u>On</u>
	White Balance	<u>Off</u> / On
	Metering	<u>Off</u> / On
	Focus	<u>Off</u> / On
	Sensitivity	<u>Off</u> / On
	Digital Zoom	Off / <u>On</u>
	EV Shift	<u>Off</u> / On
Reset		
Card Browser	<u>Off</u> / Type1 / Type2 / Type3 / Type4	
Format	<u>No</u> / Yes	

REFERENCE

Date	Date Style	<u>Year/Month/Day</u> Day/Month/Year Month/Day/Year
	Adjust	Time setting
Video Out	<u>NTSC</u> / PAL	
Language	Initial default setting is English.	
Beep	Off / <u>On</u>	
Reset	<u>No</u> / Yes	

PLAY mode

Menu	Available Settings	
Delete	Select / Folder / All	
Protect	Select / Folder / All	
DPOF	Select / Folder / All	
Resize	<u>No</u> / Yes	
Slide Show		
Card Browser	<u>Off</u> / Type1 / Type2 / Type3 / Type4	
Format	<u>No</u> / Yes	
Date	Date Style	<u>Year/Month/Day</u> Day/Month/Year Month/Day/Year
	Adjust	Time setting
Video Out	<u>NTSC</u> / PAL	
Language	Initial default setting is English.	
Beep	Off / <u>On</u>	
Reset	<u>No</u> / Yes	

Mode Settings

Settings in Each Mode

○ : Available × : Not available

		Partial Shutter Release Button Press		Flash Mode	Self-timer	Focus Frame Display
		AF Lock	AE Lock			
Drive Mode	1-Image	○	○	○	○	○
	Continuous	○	○	×	×	○
	AEB	○	○	×	×	○
	Movie	×	×	×	×	×
	Panorama	○	○	○	○	○
Exposure Mode	A Mode	○	○	×	○	○
	P Mode	○	○	○	○	○
	A Mode	○	○	○	○	○
	S Mode	○	○	○	○	○
	M Mode	○	○	○	○	○
	BS Mode	○	○	○	○	○

Drive Mode + Exposure Mode Combinations

The following table shows to what extent each drive mode can be used in combination with each exposure mode.

○ : Available △ : Partially available × : Not available

		Exposure Mode					
		A Mode	P Mode	A Mode	S Mode	M Mode	BS Mode
Drive Mode	1-Image	○	○	○	○	○	○
	Continuous	○	○	○	○	○	△ ^{*1}
	AEB	○	○	○	○	○	△ ^{*1}
	Movie	○	○	○	○	○	× ^{*2}
	Panorama	○	○	○	○	○	× ^{*2}

^{*1} Continuous shutter and AEB are not supported for some scenes.

^{*2} Selecting **BS** Mode in the Movie Mode enters the Full Auto Movie Mode.

Selecting **BS** Mode in the Panorama Mode enters the Full Auto Panorama Mode.

Full Auto Mode Settings

The following are the settings that are selected automatically by the camera in the Full Auto Mode. You cannot change these settings manually.

Menu Settings

Menu Item	Setting
Sensitivity	Auto
Enhancement	Off
Filter	Off
Saturation	+1
Contrast	0
Sharpness	+1
Flash Setting	Front-curtain Flashsync
Flash Intensity	Normal
Sync Speed	Normal
Digital Zoom	Off
Focus Expansion	Off
Grid	Off





Non-Menu Settings

Item	Setting
Metering	Multi-pattern
White Balance	Auto
Focus	Multi-area AF
Flash	Auto

▶▶ IMPORTANT! ◀◀

- You can change the settings of the other menu items shown on page 159.

Troubleshooting

	Symptom	Probable Cause	Action
Power Supply	No power	<ol style="list-style-type: none"> 1. Batteries are not oriented correctly. 2. Batteries are dead. 3. Using the wrong AC adaptor. 	<ol style="list-style-type: none"> 1. Load batteries correctly (page 29). 2. Replace batteries with a full set of new ones (page 29). 3. Use only the specified AC adaptor (AD-C620).
	Sudden loss of power	<ol style="list-style-type: none"> 1. Activation of Auto Power Off (page 35). 2. Dead batteries 3. You are aligning the Power/function switch with  while the lens cap is attached. 	<ol style="list-style-type: none"> 1. Turn power back on. 2. Replace batteries with a full set of new ones (page 29). 3. Remove the lens cap and then turn on power.
	 indicator on the monitor screen and Viewfinder	Batteries are low.	Replace batteries with a full set of new ones (page 29).
Recording	No recording when the shutter release button is pressed	<ol style="list-style-type: none"> 1. The power/function switch is aligned with . 2. Flash unit is charging. 3. The message "MEMORY FULL" is on the monitor screen. 4. No memory card loaded in the camera 	<ol style="list-style-type: none"> 1. Align the power/function switch with . 2. Wait until flash unit charging is finished. 3. Delete images you no longer need from camera memory or change to another memory card. 4. Load a memory card.
	Unable to focus properly with Auto Focus	<ol style="list-style-type: none"> 1. Dirty lens 2. Subject is outside the focus frame. 3. Conditions make it impossible to obtain proper focus. 4. Camera is unsteady or shaking. 	<ol style="list-style-type: none"> 1. Clean the lens. 2. Compose the image so the subject is inside the focus frame. 3. Switch to the Manual Focus Mode and focus manually (page 64). 4. Use a tripod.

REFERENCE

	Symptom	Probable Cause	Action
Recording	Unable to perform MENU and other button operations	Full Auto is selected as the exposure mode.	Change to another exposure mode.
	Recorded image is blurred.	Improper focus	Make sure the subject on which you want to focus is inside the focus frame.
	Power failure during self-timer operation.	Batteries are dead.	Replace batteries with a full set of new ones (page 29).
	Monitor screen image is out of focus.	<ol style="list-style-type: none"> Poor focusing in the manual focus mode. Attempting to record scenery or portraits in the Macro Mode. Attempting to use the Auto Focus mode for a subject that is too close. 	<ol style="list-style-type: none"> Focus the image (page 64). Use Auto Focus for scenery and portraits. Use the Macro Mode for close ups.
	Recorded image is not saved.	<ol style="list-style-type: none"> Batteries going low before the image save operation is complete. Opening of the memory card slot cover before the image save operation is complete. 	<ol style="list-style-type: none"> Replace batteries with a full set of new ones. Keep the memory card cover closed until the image save operation is complete.
Playback	Colors of recorded image are different from those on the monitor screen.	<ol style="list-style-type: none"> Direct sunlight or light from another source shining into the lens. Image quality setting 	<ol style="list-style-type: none"> Reorient the camera so that light is not shining directly into lens. Change to a higher image quality for recording.
	Control button does not work while the 9-image view is on the monitor screen.	You are operating the control button while the scroll operation is still being performed.	Wait until image scrolling is complete before rocking the control button to the left or right.

REFERENCE

	Symptom	Probable Cause	Action
Playback	Cannot display a particular image.	Memory card images recording using a camera that does not support DCF.	The file management systems of cameras that do not support DCF are different from the one used by this camera. This camera cannot read cards recorded with such cameras.
	Monitor screen contents do not appear on the screen of a connected TV.	<ol style="list-style-type: none"> 1. Incorrect camera-TV connection 2. Wrong TV settings 3. Wrong video signal output mode 	<ol style="list-style-type: none"> 1. Connect correctly using the video cable (page 137). 2. Check the documentation that comes with the TV and set it up correctly for video input. 3. Select the video output mode that suits the type of equipment you are using (page 138).
Deletion	Cannot access the delete screen.	All images on the memory card are protected.	Unprotect the images you want to delete (page 125).
Other	Cannot select menu items in the PLAY mode.	<ol style="list-style-type: none"> 1. Some functions cannot be selected for playback of certain types of images. 2. No images stored on the memory card. 	<ol style="list-style-type: none"> 1. Select a different function or change to another image. 2. Record an image to make the functions available.
	All buttons and switches are dead.	Circuit damage due to static electrical charge from connected device or due to strong impact.	Remove batteries and disconnect the AC adaptor if you are using one. Restore power and turn the camera on. If this does not work, contact your dealer or an authorized CASIO service provider.
	Nothing appears on the monitor screen.	<ol style="list-style-type: none"> 1. The monitor is asleep. 2. Communication over the USB cable is in progress. 	<ol style="list-style-type: none"> 1. Wake up the monitor (page 35). 2. After the communication operation over the USB cable is complete, unplug the USB cable from the camera.

Messages

RECORD ERROR Some problem occurred when compressing image data to save it on the memory card. Shoot the image again.

There are no images on this memory card! There is no image data stored on the memory card.

This camera cannot display the image you selected! The image file you are trying to view is corrupted, or it was recorded with a camera whose image file format is not supported by this camera.

REPLACE BATTERY! Battery power is low. Camera power turns off automatically shortly after this message appears.

NOT FORMAT → MENU The memory card you are using is not formatted. You must format the memory card before you can use it to store images (page 39).

CF ERROR There is some problem with the memory card you are using. Perform the following procedure to correct the problem.

To use this card, you must turn the camera off and then back on again. If this message appears again, you need to format this CompactFlash card.
FORMAT → MENU

Warning!

The following procedure deletes all files currently stored on the memory card. Before proceeding, try to back up the contents of the memory card onto your computer's hard disk drive or some other type of external storage medium.

1. Press MENU.

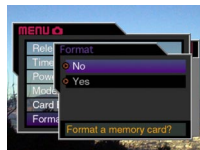

2. Rock the control button up or down to select "Yes" and then click the control button.
- To cancel this procedure, press MENU.
 - Whenever formatting a memory card, be sure to use the AC adaptor to power the camera or replace its batteries with a full set of new alkaline or lithium batteries before starting. Unexpected loss of power can result in incomplete formatting and improper operation of the memory card.
 - The message "There are no images on this memory card!" appears on the monitor screen after formatting is complete.
-

REFERENCE



Insert memory card!

There is no memory card loaded in the camera. Load a memory card (page 37).

MEMORY FULL
Change quality/size
or delete unneeded
images

There is not enough memory to record an image with your current quality and size settings. Change the image quality and size settings and try again, or delete some images from the memory card (pages 94, 120).

MEMORY FULL
Delete unneeded
images

- There is not enough memory for further recording. Delete some images you don't need from memory card (page 120).
 - The DCIM folder or some file (page 151) cannot be created due to insufficient memory when downloading data from a computer to the memory card. Use your computer to delete unneeded images to free up memory card space for the images you are downloading. You could also press MENU and format the memory card in the camera, but doing so deletes all image files currently stored on the memory card.
-

LENS CAP

- This message appears and power turns off automatically if you align the power/function switch with  and the lens cap is attached. Remove the lens cap and then turn on power.
-

REFERENCE

Specifications

- Description** Digital camera
- Model** QV-5700
- Recorded Image File Format** Still images (including panoramas): JPEG (Exif. Ver. 2.2)/TIFF, DCF standard (Design rule for Camera File system), DPOF compatible
Movies: AVI (Motion JPEG)
- Recording Medium** CompactFlash card (Type I/II), IBM Microdrive
- Recorded Image Size** 2560 x 1920 pixels, 2544 x 1696 (3:2) pixels, 1600 x 1200 pixels, 1280 x 960 pixels, 640 x 480 pixels

Standard Memory Capacity, Number of Image Files, Computer Output Image Size (JPEG images only)

Still					
Image size (pixels)	Quality	File size	Number of images		
			16MB memory card	64MB memory card	1GB Microdrive
2560 X 1920	FINE	2.3MB	6 images	24 images	410 images
	NORMAL	1.8MB	7 images	30 images	513 images
	ECONOMY	1.3MB	10 images	40 images	684 images
	TIFF	14.4MB	—	3 images	65 images
2544 X 1696 (3:2)	FINE	2.0MB	6 images	27 images	466 images
	NORMAL	1.6MB	8 images	33 images	570 images
	ECONOMY	1.1MB	12 images	50 images	855 images
	TIFF	12.64MB	1 image	4 images	75 images

1600 X 1200	FINE	1.02MB	12 images	50 images	855 images
	NORMAL	0.68MB	18 images	75 images	1266 images
	ECONOMY	0.34MB	35 images	144 images	2445 images
	TIFF	5.625MB	2 images	10 images	173 images
1280 X 960	FINE	0.65MB	19 images	77 images	1314 images
	NORMAL	0.43MB	28 images	113 images	1911 images
	ECONOMY	0.22MB	53 images	214 images	3625 images
	TIFF	3.6MB	3 images	15 images	270 images
640 X 480	FINE	0.16MB	73 images	296 images	5006 images
	NORMAL	0.11MB	103 images	415 images	7009 images
	ECONOMY	0.06MB	154 images	622 images	9999 images*1
	TIFF	0.9MB	15 images	62 images	1049 images

*1 Maximum value displayed by the camera. Actual image capacity is greater than this value.

Movie (320 x 240 pixels)	
Storage Capacity	Approximately 300KB/second
Recording Time	30 seconds per movie

- The above figures are approximations only.

Image Deletion Single image; all images in a folder; all images in memory (with image protection)

Imaging Element 1/1.8-inch CCD (Total Pixels: 5.36 million, Effective Pixels; 5.0 million)

Lens F2 (W) to 2.5 (T); f = 7 (W) to 21mm (T) (equivalent to approximately 34 (W) to 102mm (T) for 35mm film)

REFERENCE

Zoom 3X optical zoom; 3.2X digital zoom
(9.6X in combination with optical zoom)

Focusing Contrast-type Multi-area Auto Focus
(Spot Auto Focus Mode, Macro Mode, Infinity Mode); manual focus; focus lock

Approximate Focus Range

Normal: 30cm to ∞
(11.8" to ∞)

Macro: 6cm (W)/20cm (T) to 50cm
(2.4" (W)/7.9" (T) to 19.7")

Manual Focus: 6cm (W)/20cm (T) to ∞
(2.4" (W)/7.9" (T) to ∞)
Distance from lens surface to subject

Exposure Control

Light Metering: Multi-pattern, center-weighted, spot by
CCD

Exposure: Full Auto, Program AE, Shutter priority
AE, Aperture priority AE, Manual

Exposure
Compensation: -2EV to +2EV (1/3EV units)

Shutter CCD electronic shutter; mechanical
shutter, BULB, 60 to 1/1000 second

Aperture F2.0/2.3/2.8/4.0/5.6/8.0, auto switching
or manual switching

White Balance Automatic, fixed (4 modes), manual
switching

Self-timer 10 seconds, 2 seconds

Built-in Flash

Flash Modes: AUTO, ON, OFF, Red eye reduction

Flash Range: Approximately 0.5 to 3 meters
(1.6' to 9.8')

Recording Functions One-shot, continuous, movie, pan-
orama, AEB, self-timer, macro, Best
Shot

Monitor 1.8" TFT, low-glare color HAST LCD
(122,100 pixels, 555 x 220)

Viewfinder LCD Monitor or optical viewfinder

Clock Built-in quartz digital timepiece for time
and date recording and storage with im-
age data; auto calendar up to 2049

Input/Output Terminals Remote shutter release terminal; AC
adaptor terminal; USB port (Mini-B);
VIDEO OUT (NTSC/PAL)

Power Requirements Four AA-size alkaline or lithium batter-
ies
Four AA-size nickel-metal hydride re-
chargeable batteries (NP-H3)
AC adaptor (AD-C620)
AC adaptor charger (BC-3HA)

REFERENCE

Battery Life

The values noted below indicate the number of hours before battery failure under normal operating temperature (25°C (77°F)). These values are for reference only, and do not guarantee that any particular set of batteries actually will provide the service life indicated. Low temperatures shorten battery life (page 30).

Type of Operation	Continuous Playback	Continuous Recording
AA-size Alkaline Batteries LR6	180 minutes	75 minutes (460 shots)
AA-size Lithium Batteries FR6	320 minutes	180 minutes (1130 shots)
AA-size Ni-MH Batteries NP-H3	180 minutes	90 minutes (540 shots)

- The above figures are approximations only.
- The above guidelines are based on the following battery types:
 - Alkaline: MX1500 (AA) DURACELL ULTRA
 - Lithium: Energizer
- Battery life varies with brand.

Continuous recording values show the number of shots without using the flash. The number of shots depends on use of the flash and whether flash is turned on or off.

Power Consumption Approximately 6.8W

Dimensions 118(W) x 74.5(H) x 64.5(D) mm
(4.6~(W) x 2.9~(H) x 2.5~(D))

Weight Approximately 355g (12.5oz)
(excluding batteries)

- This camera does not have a separate battery to power its clock. Clock settings are cleared whenever power to the camera is cut off (by batteries going dead while the camera is not connected to an AC power outlet with the AC adaptor) for about 24 hours. After power is resumed, either by loading fresh batteries or connecting to an AC power outlet, you will have to set the correct time and date again.
- The liquid crystal panel built into this camera is the product of precision engineering, with a pixel yield of 99.99%. This also means, however that 0.01% of the pixels can be expected to fail to light or to remain lit at all times.