

RECORDING IMAGES

This section describes the basic procedure for recording an image.

Recording a Simple Snapshot

Use the snapshot mode to record simple snapshots. Your camera automatically adjusts shutter speed and aperture settings in accordance with the brightness of the subject.

1. Move the POWER ON/OFF switch to ON.

- This causes an image or a message to appear on the monitor screen.

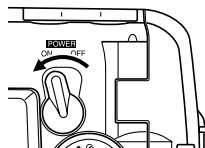

2. Align the dial with (snapshot mode).

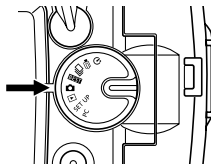

3. Compose the image on the monitor screen.

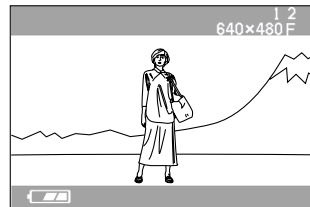

- The focusing range of the camera is approximately 60 cm (23.6") to infinity (∞).
- You can compose images using either the monitor screen or the optical viewfinder (page 52).
- When using the optical viewfinder to compose images, you can use DISP to turn off the monitor screen and conserve battery power.

4. Press the shutter release button about half way to lock the exposure (AE Lock).

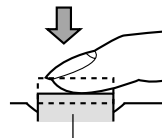

Shutter release button

- When performing this step, take care so your fingers do not block the lens or any of the sensors.

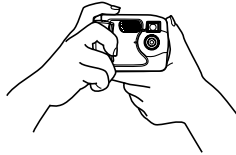

5. Press the shutter release button the rest of the way to record the image.

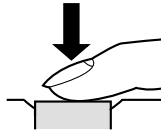

- Recorded images are temporarily stored in a buffer, from which they are saved on the memory card installed in the camera. You can continue to store images as long as there is space available in the buffer.
- The number of images you can store in the camera depends on the storage medium and the image quality setting (page 56) you are using.
- To avoid hand movement, press the shutter release button gently.
- When available lighting is dim, use of a tripod is recommended to protect against hand movement.

About the REC Mode Monitor Screen

- The image shown on the monitor screen in the REC mode is a simplified image for composing purposes. The actual image is recorded in accordance with the image quality setting currently selected on your camera. The image saved on the memory card has much better resolution and detail than the REC mode monitor screen image.
- Certain levels of subject brightness can cause the response of the REC mode monitor screen to slow down, which causes some static noise in the monitor screen image.

Recording Precautions



- Never open the battery cover, disconnect the AC adaptor from the camera, or unplug the adaptor from the wall socket while the operation lamp is flashing green. Doing so will not only make storage of the current image impossible, it can also corrupt other image data already saved on the camera's memory card.
- Never remove batteries, unplug the AC adapter, or remove the memory card while the camera is saving images.
- Fluorescent lighting actually flickers at a frequency that cannot be detected by the human eye. When using the camera indoors under such lighting, you may experience some brightness or color problems with recorded images.

Image Recording when Batteries are Low



Normally, the camera temporarily stores images you record into buffer memory, and then transfers them to the memory card. This is done in order to shorten the wait time between shots. When the battery level is indicated by  on the monitor screen, however, the camera bypasses buffer memory and saves images directly to the memory card. This causes the wait interval between shots to become longer than it usually is.

Using Zoom

You can use the digital zoom feature of your camera to zoom in on the center of an image. Performing a zoom operation toggles the zoom factor between 2X and 1X.

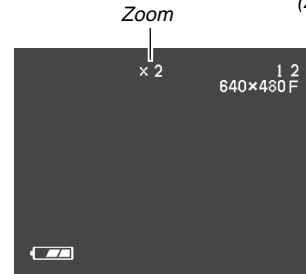
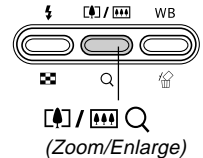

1. In a recording mode, press  /   to change the zoom factor.





- Each press of  /   toggles between the two available zoom factors and displays the current setting on the monitor screen.
- Note that digital zoom is disabled in the case of a 1600 x 1200 size image and in the movie mode.

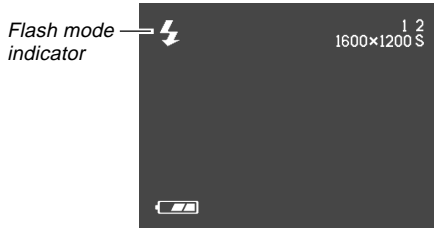
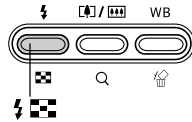

Using the Flash

The following describes various flash settings you can make to suit the type of image you are trying to record.

1. In a recording mode, press   to cycle through the flash mode settings until the one you want is indicated on the monitor screen.



- Each press of   cycles through the available flash modes described below.

To do this:	Select this setting:
Have the flash fire automatically when required (Auto Flash)	No display
Always fire the flash (Flash On)	
Turn off the flash (Flash Off)	

Flash Status Indicators

You can find out the current flash unit status by checking the monitor screen and the operation lamp.

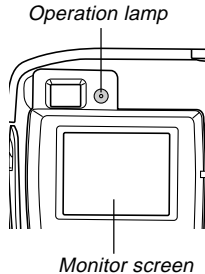

■ Operation Lamp

If the operation lamp is doing this:	It means this:
Flashing amber	Flash unit is charging.
Flashing red	Flash unit cannot charge for some reason.

■ Monitor Screen

 is shown on the monitor screen when auto flash is selected.

Precautions when Using Flash

- Make sure that you do not touch or block the flash or the exposure sensor with your fingers. Doing so can soil these components and interfere with correct flash operation.

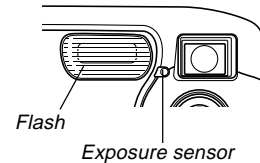



- The effective range for the built-in flash is approximately 0.6m to 2m (2.0' to 6.6') (at full aperture). Note that you may not be able to obtain the desired flash result outside the ranges noted above.
- Depending on operating conditions (type of batteries being used, temperature, etc.), it may take up to 10 seconds for the flash unit to charge.
- The flash does not fire in the continuous shutter mode or movie mode. This is indicated by  on the monitor screen.

- The flash unit does not charge when battery power is too low to charge the flash. The  (Flash Off) indicator appears to warn you that the flash will not fire correctly, which may affect exposure of the image. Replace batteries as soon as possible when this happens.
- White balance is fixed while the flash is being used, so sunlight, fluorescent lighting, or other sources of illumination in the immediate area may affect the coloring of the recorded image.

Recording Macro Images



You can select either normal or macro (close-up) recording using the selector located on the left side of the camera. The table below describes the two settings available with the selector.

To do this:	Select this setting:
Shoot normal images, at a distance of about 60cm (23.6") to infinity (Normal)	
Shoot close-ups, at a distance of about 10cm (3.9") (Macro)	

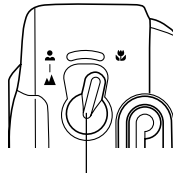
- The distances indicated above represent the distance from the camera's lens surface to the subject.



Normal/Macro selector

- Selecting the macro mode causes the  indicator to appear on the monitor screen.
- Normally, you should leave the Norma/IMacro selector setting at .

Using the Optical Viewfinder

Note the following points whenever you use the optical viewfinder to compose images.

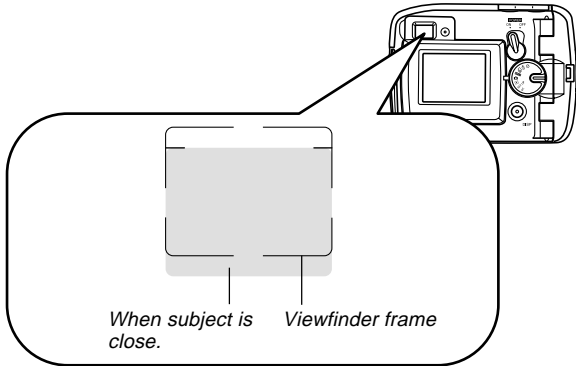

The frame that is visible inside of the viewfinder indicates the image recorded at a distance of about three meters (9.8'). When the subject is closer or further away than three meters (9.8'), the recorded image will be different from what you see inside the viewfinder frame.

When recording a subject that is closer than 10cm (0.4") from the lens, set the Normal/Macro selector to .

- Entering the macro mode or continuous shutter mode causes the monitor screen to turn on automatically. Use the monitor screen to compose images in these modes.

Recording Consecutive Images (Continuous Shutter Mode)

The continuous shutter mode records images as long as you keep the shutter release button depressed. Note that the length of the interval between images depends on the image quality setting.

1. Align the dial with  (Continuous Shutter Mode).
2. Hold down the shutter release button to record the images you want.

- Images start to be saved to the memory card when you release the shutter release button.

IMPORTANT!

- The flash does not fire during continuous shutter recording.
- You cannot use the self-timer in combination with the continuous shutter mode.
- Continuous shutter recording is disabled while the  battery indicator is on the monitor screen.
- Never remove the batteries or memory card from the camera or unplug the AC adaptor while images are being saved to memory.
- The continuous shutter mode is disabled when "1600 x 1200 SUPER" is selected for "SIZE/QUALITY". In this case, you must use the snapshot mode.

Recording with the self-timer

The self-timer counts down for 10 seconds before releasing the shutter.

1. Align the dial with  (self-timer mode).
2. Compose the image and then press the shutter release button.

- The self-timer lamp flashes and the shutter releases in about 10 seconds.
- The monitor screen turns off while the countdown is being performed.
- You can interrupt an ongoing self-timer countdown by pressing the shutter release button while the self-timer lamp is flashing.

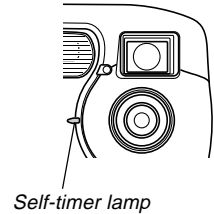

Recording an Image Using a Best Shot Mode Scene

Selecting one of the 18 Best Shot scenes automatically sets up the camera for recording a similar type of image.

■ Recording Example

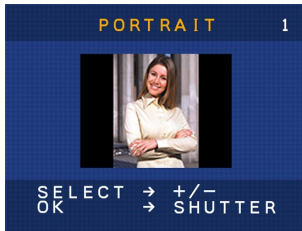

Select "PORTRAIT" to record the image of a person with vertical (portrait) orientation.

■ Composition Outline

Selecting certain Best Shot scenes causes a composition outline to appear on the monitor screen. Use the composition outline to compose your image and achieve proper balance.

Composition outline

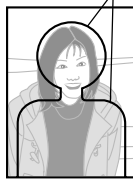

Example: Portrait

1. Align the dial with **BEST** (Best Shot mode).

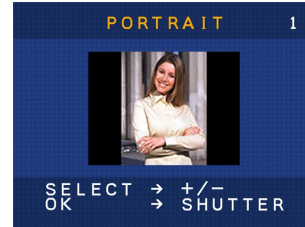

2. Use [+] and [-] to select the Best Shot scene you want to use and then press the shutter release button.
3. Compose the image and then press the shutter release button.

NOTES

- Best Shot scenes were not recorded using this camera. They are provided as samples only.
- Images recorded using a Best Shot scene may not produce the results you expected due to shooting conditions and other factors.
- The first scene that appears when you enter the Best Shot mode is the one that was on the display when you last exited the mode.
- You cannot use exposure compensation (EV shift) in the Best Shot mode.
- After you select a Best Shot scene, you can change to another scene using [+] and [-].

Recording a Movie (Movie Mode)

You can record movies up to 10 seconds long.

- **File Format: AVI**
AVI format conforms to the Motion JPEG format promoted by the Open DML Group. Note, however, that this camera does not support audio data.
- **Image Size: 320 x 240 pixels**
- **Movie Size**
Storage Capacity: Approximately 300 KB per second
Maximum Length Per Movie: 10 seconds

1. Align the dial with  (movie mode).

2. Press the shutter release button all the way down to start recording.

- Recording continues for 10 seconds.
- You can interrupt movie recording before 10 seconds are up by pressing the shutter release button again. Saving of the movie to the memory card starts at this time.

IMPORTANT!

- The flash does not fire during movie recording.
- To view an AVI file under Windows 98 or 2000, install DirectX from the CD-ROM that comes bundled with the camera.

Specifying Image Size and Quality

You can specify the image size and image quality to suit the type of image you are recording.

1. Align the dial with **SET UP**.
2. Use **[+]** and **[-]** to select “**SIZE/QUALITY**” and then press the shutter release button.
3. Use **[+]** and **[-]** to select the setting you want and then press the shutter release button.

■ **Size/Quality Setting**

Image size (pixels)	Quality	File size
1600 x 1200	SUPER	850KB
1280 x 960	FINE	500KB
	NORMAL	350KB
640 x 480	FINE	150KB
	NORMAL	90KB

IMPORTANT!

- The values in the table above are all approximate, and are affected by the types of images you record and other factors.
- To determine the number of images that can be stored on a memory card of a different capacity, multiply the capacities in the table above, by the appropriate value.
- The maximum number of images indicated on the monitor screen is 999.

Exposure Compensation

Whenever program AE, shutter speed priority AE, or aperture priority AE is selected as the exposure mode, you can adjust the exposure compensation value (EV value) within the range shown below in order to compensate for current lighting conditions. This setting can be used to obtain better results when shooting with backlighting, indirect indoor lighting, a dark background, etc.

EV Value Range: -2EV to +2EV
Steps: 1/3EV

1. In a recording mode, use [+] and [-] to perform exposure compensation (EV Shift).

- This causes the exposure compensation value to appear on the monitor screen.



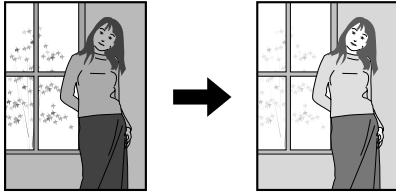

Exposure compensation indicator

[+]: Increases the EV value. A higher EV value is best used for light-colored subjects and backlit subjects.

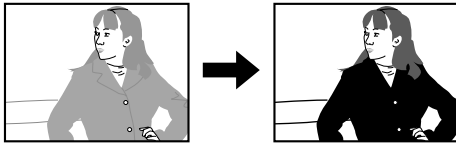

[-]: Decreases the EV value. A lower EV value is best for dark-color subjects and for shooting outdoors on a clear day.



- To return exposure compensation to its standard default setting, use [+] and [-] to change the setting on the monitor screen until  disappears.

2. Compose the image and then press the shutter release button.

IMPORTANT!

- When shooting under very dark or very bright conditions, you may not be able to obtain satisfactory results even after performing exposure compensation.

Selecting White Balance

Selecting the right type of white balance can help to make the colors of a subject appear most natural under the type of lighting that is available.

1. In a recording mode, press WB  to change the white balance setting.

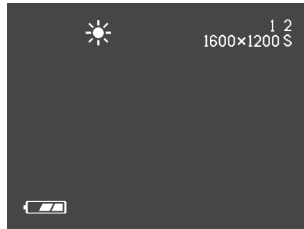

- Each press of WB  cycles through the white balance settings on the monitor screen in the sequence shown below.

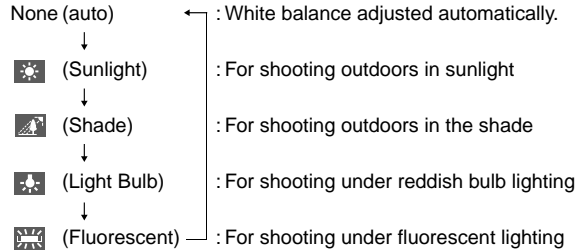

You can use the camera's built-in monitor screen to play back recorded images.

Basic Playback Operation

Use the following procedure to scroll through recorded images stored in the camera's memory.

1. Align the dial with  (play mode).
2. Use [+] and [-] to scroll through images on the monitor screen.



To do this:	Press this button:
Scroll forward	[+]
Scroll back	[-]

NOTES

- Holding down [+] or [-] scrolls images at high speed.
- In order to allow for faster playback image scrolling, the image that initially appears on the monitor screen is a preview image, which is of somewhat lower quality than the actual display image. The actual display image appears about three seconds after the preview image. This does not apply to images copied from another digital camera.

Playing a Movie

Use the following procedure to play back a movie recorded in the movie mode.

1. Align the dial with  (play mode).
2. Use [+] and [-] to scroll through the movies in camera memory until you find the one you want.

Movie mode indicator







3. Press the shutter release button to play back the movie.



- Press   or  /   to stop movie playback.

Enlarging the Playback Image

Perform the following procedure to zoom the image currently on the monitor screen.

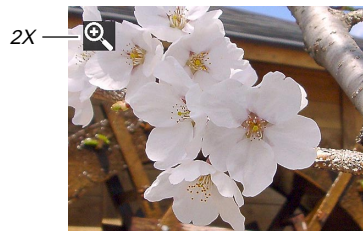
1. Align the dial with  (play mode).
2. Use [+] and [-] to scroll through images until the one you want is displayed.
3. Press  /   to enlarge the currently displayed image.



- Each press of  /   toggles the zoom factor between 1X and 2X.



To do this:	Press this button:
Scroll the enlarged image to the right.	[+]
Scroll the enlarged image to the left.	[-]
Exit image enlargement	Shutter release

IMPORTANT!

- You cannot enlarge a movie image.

Displaying the 9-image View

The following procedure displays nine images on the monitor screen at the same time.

- Align the dial with  (play mode).
- Press .

- This displays the 9-image view.

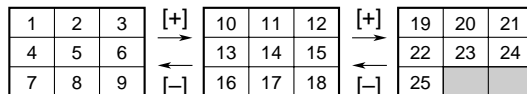

To do this:	Press this button:
Scroll forward	[+]
Scroll back	[-]

- To exit the 9-image screen, press any button besides [+], [-], and DISP.

Selecting a Specific Image in the 9-image View

1. Display the 9-image screen.
2. Press DISP.
 - This causes a selection frame to appear on the display.



3. Use [+] and [-] to move the selection frame to the image you want to display, and then press the shutter release button.
 - This displays the full-size version of the image you selected.



DELETING IMAGES



You can delete images individually (displayed image), or you can delete images in memory that are not protected.

IMPORTANT!

- Note that image deletion cannot be undone. Once you delete an image, it is gone. Make sure you really do not need an image anymore before you delete it. Especially when deleting all images, make sure you check all the images you have stored on the camera before proceeding.

Deleting the Displayed Image

Use the following procedure when you want to delete the image that is currently on the monitor screen.

1. Align the dial with  (play mode).
2. Use [+] and [-] to scroll through images until the one you want to delete is displayed.
3. Press WB .

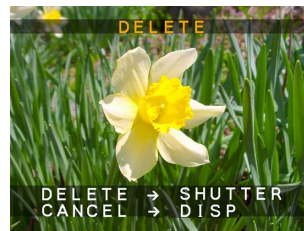

4. A message appears to confirm whether you really want to delete the displayed image.
 - If you want to cancel the procedure without deleting the image, press DISP.

5. Press the shutter release button to delete the image.

NOTE

- The camera does not maintain open spaces in its memory. Deleting an image causes images following the deleted image to be shifted up to fill in the empty space. Note, however, that file names are not changed.

Shot number	100-1	100-2	100-3	100-4
DCF File Name	100-0001	100-0002	100-0003	100-0004



Shot number	100-1	100-2	100-3
DCF File Name	100-0001	100-0002	100-0004



Deleting All Images

The following procedure deletes all unprotected images currently in memory.

- Align the dial with **SET UP**.
- Use **[+]** and **[-]** to select **“DELETE/FORMAT”** and then press the shutter release button.
- Use **[+]** and **[-]** to select **“DELETE ALL”** and then press the shutter release button.
- Use **[+]** and **[-]** to select **“YES”** and then press the shutter release button.
 - To cancel the delete operation without deleting anything, select **“NO”** instead of **“YES”** and then press the shutter release button.

MANAGING IMAGES

This section contains information about how images are stored in memory. It also explains how you can specify print settings.

Folders and Files

Your camera automatically creates a directory of folders on the memory card to store images.

Folders

A folder is created automatically whenever you shoot the first image on a particular date. The name assigned to the folder is based on the current date, as described below. You can have up to 900 folders on a memory card at the same time (subject to storage capacity restrictions).

Example: Folder created on July 19, which is the 100th folder on the memory card

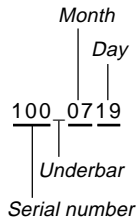

Files

The names assigned to files are based on the current date, as shown below.

Example: 26th image shot on November 7

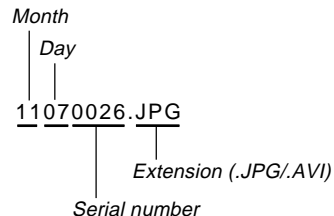

- In addition to image files, memory cards also contain a number of other files used by the system for image data management.
- The actual number of files you will be able to store on a memory card depends on the capacity of the card, image quality settings, etc.

DPOF

The letters “DPOF” stand for “Digital Print Order Format”, which is a format for recording on a memory card or other medium which digital camera images should be printed and how many copies of the image should be printed. Then you can print on a DPOF-compatible printer or at a professional print service from the memory card in accordance with the images and number of copies settings recorded on the card.



■ DPOF Settings

Images, number of copies, date

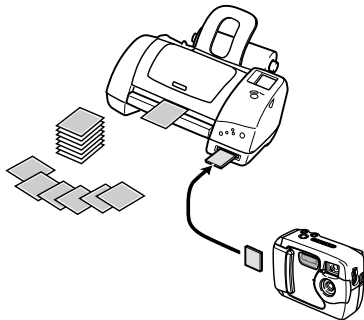

To configure printing for a particular image

1. Align the dial with SET UP.
2. Use [+] and [-] to select “PRINT ORDER” and then press the shutter release button.
3. Use [+] and [-] to select “SELECT IMAGES” and then press the shutter release button.



- If the memory card does not have DPOF settings already configured on it, skip step 4 and proceed from step 5.

4. If the memory card is already configured with DPOF settings, use [+] and [-] to select “RE-SET” or “EDIT” and then press the shutter release button.

To do this:	Select this option:
Delete the existing settings	RESET
Edit the existing settings	EDIT

5. Use [+] and [-] to select the image you want to print and then press the shutter release button.
6. Use [+] and [-] to specify the number of copies you want to print and then press the shutter release button.
7. Use [+] and [-] to specify whether or not you want to insert a date stamp into the image and then press the shutter release button.
- Some printers may not support date stamp printing.
 - Repeat steps 5 through 7 to configure settings for other images, if you want.
8. Press DISP to complete the procedure.

To print all images

1. Align the dial with SET UP.
2. Use [+] and [-] to select “PRINT ORDER” and then press the shutter release button.
3. Use [+] and [-] to select “ALL IMAGES” and then press the shutter release button.
 - If the memory card does not have DPOF settings already configured on it, skip step 4 and proceed from step 5.
4. If the memory card is already configured with DPOF settings, use [+] and [-] to select “RE-SET” or “EDIT” and then press the shutter release button.

To do this:	Select this option:
Delete the existing settings	RESET
Edit the existing settings	EDIT

5. Use [+] and [-] to specify the number of copies you want to print and then press the shutter release button.
6. Use [+] and [-] to specify whether or not you want to insert a date stamp into the image and then press the shutter release button.
 - Some printers may not support date stamp printing.
7. Press DISP to complete the procedure.

PRINT Image Matching

This camera supports PRINT Image Matching, which means that images recorded with it include information about the mode settings, camera setup, etc. When you print an image on a printer that supports PRINT Image Matching, the printer reads this data and adjusts the printed image accordingly, so your images come out just the way you intended when you recorded them. See the documentation that came with your printer for full details about PRINT Image Matching.

- * PRINT Image Matching is a term for the print command that is embedded in header file of the image created by Digital Camera. It contains color setting and image parameter information.
- * SEIKO EPSON Corporation holds the copyright for PRINT Image Matching Version 1.0.



OTHER SETTINGS

Changing the Display Language

You can use the following procedure to select one of six languages as the display language.

1. Align the dial with **SET UP**.
2. Use **[+]** and **[-]** to select “**LANGUAGE**” and then press the shutter release button.
3. Use **[+]** and **[-]** to select the setting you want and then press the shutter release button.

To specify this display language:	Select this option:
English	ENGLISH
Spanish	ESPAÑOL
German	DEUTSCH
French	FRANÇAIS
Italian	ITALIANO
Japanese	JAPANESE

Turning the Confirmation Beep On and Off

Perform the following steps to turn the button confirmation beep on and off.

1. Align the dial with **SET UP**.
2. Use **[+]** and **[-]** to select “**BUZZER**” and then press the shutter release button.
3. Use **[+]** and **[-]** to select the setting you want and then press the shutter release button.

To do this:	Select this option:
Turn on the confirmation beep	ON
Turn off the confirmation beep	OFF

Specifying the Opening Screen

Use the following procedure to specify the format of the opening screen that appears whenever the camera is turned on or off.

1. Align the dial with **SET UP**.
2. Use **[+]** and **[-]** to select “**OPENING**” and then press the shutter release button.
3. Use **[+]** and **[-]** to select the opening screen you want and then press the shutter release button.

To do this:	Select this option:
Display Opening Screen 1 whenever power is turned on or off	TYPE 1
Display Opening Screen 2 whenever power is turned on or off	TYPE 2
Turn the opening screen off (no display)	OFF

Selecting the USB Mode

The USB port of your camera supports both mass storage class and image class. Use the following procedure to select the mode that suits the type of USB connection you need.

1. Align the dial with **SET UP**.
2. Use **[+]** and **[-]** to select “**USB**” and then press the shutter release button.
3. Use **[+]** and **[-]** to select the setting you want and then press the shutter release button.

To do this:	Select this option:
Save images you record on a computer hard disk (mass storage class, page 73)	NORMAL
Use the camera as a PC camera for video conferencing (image class, page 78)	PC CAMERA

IMPORTANT!

- Use the AC adaptor to power the camera whenever transferring data over a USB connection.

CONNECTING TO EXTERNAL EQUIPMENT

The camera is equipped with a USB port, which you can use to connect to a computer.

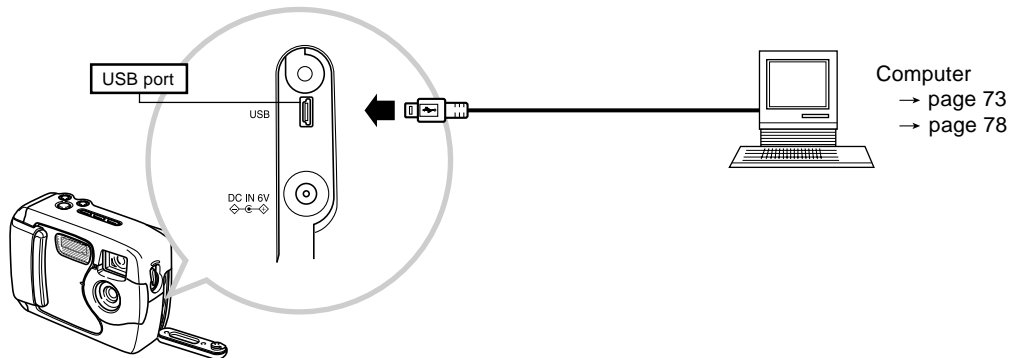

IMPORTANT!

- Be sure to turn off both the camera and the other equipment before making any connections.
- Check the documentation that comes with your other equipment for information you may need to know when making connections.
- Leaving the same image displayed on a computer display screen for very long periods can cause the image to be “burned in” on the screen. When this happens, a faint after-image remains on the screen, even after you disconnect the camera. To avoid this, you should not leave the same image displayed on such a screen for very long periods.
- This camera does not support cable transfer of data with other CASIO digital cameras.
- You cannot connect this camera to a computer’s serial port (RS-232C or RS-422).

Transferring Images to a Computer

The CD-ROM that comes bundled with your camera contains a copy of Photo Loader, which is an application that lets you transfer the contents of the camera's memory to your computer quickly and easily. You can connect to a computer that is equipped with a USB port. You can also transfer images using the memory card, if your computer is equipped to read memory cards.

USB Connection

If your computer has a USB port, you can connect it to the camera's USB port for quick and easy image data transfer. Use the USB cable that comes with the camera to connect to a computer.

The first time you connect to your computer, you will need to install the USB driver. After that, the camera becomes a peripheral (card reader/writer) recognized by your computer whenever they are connected.

Installing Photo Loader on your computer makes image transfer even easier. See the documentation that comes with the software for full details about installing and using the USB driver and Photo Loader.

IMPORTANT!

- The PC mode of this camera may not be compatible with certain computers.
- Operation is not guaranteed when the camera is connected to a USB hub or expansion USB board.

To connect to a computer

- 1. Install the USB driver onto a computer equipped with a USB port.**
 - Also install the Photo Loader application, which provides automatic image data transfer and tools for image management.
 - See the "Bundled Software User's Manual" for information about installing the driver.
- 2. Select "NORMAL" as the camera's USB mode (page 71).**
- 3. Open the terminal cover and then use the USB cable to connect the camera to the computer.**

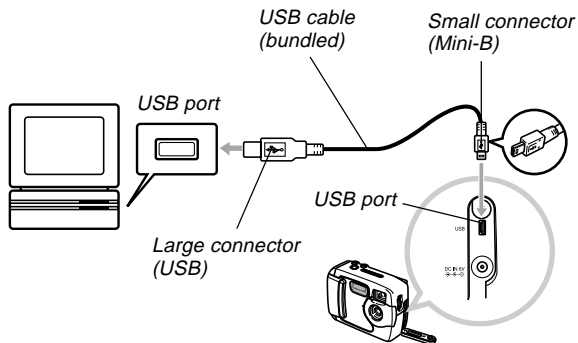

4. Move the POWER ON/OFF switch to ON and then align the dial with PC (PC mode).

- In the PC mode, all buttons and controls, including the POWER ON/OFF switch are disabled.
- The monitor screen turns off, and the operation lamp lights green.

5. Import the images to the computer.

6. After image data transfer is complete, disconnect the USB cable.

- For details, see "Disconnecting the USB Cable" (page 75).
- Take care when connecting the USB cable to the camera. The USB port and the cable plug are shaped for proper positioning, so make sure you position the plug correctly when inserting it into the port.
- Plug the USB cable into the ports securely, as far as it will go. Proper operation is not possible if connections are not correct.
- The camera does not draw power over the USB cable. After connecting the cable, turn on the camera.
- Low battery power can cause the camera to power down suddenly during data communication. Always use the optional AC adaptor to power the camera whenever performing data communication with a computer.
- Never disconnect the USB cable while data communication is in progress. Doing so can cause data to become corrupted.

Disconnecting the USB Cable

Windows Me or 98

Disconnect the USB cable from the camera, and then turn off the camera.

- After completing data communication over a USB connection, use one of the prescribed procedures below to disconnect the USB cable.
- You cannot turn off the camera while the USB cable is connected. Disconnect the USB cable before turning off the camera.

Windows XP or 2000

Click card services in the task tray on your computer screen, and disable the drive number assigned to the camera. Next, disconnect the USB cable from the camera, and then turn off the camera.

Macintosh

In Finder, drag the camera to the trashcan. Next, disconnect the USB cable from the camera and then turn off the camera.

Using a Memory Card to Transfer Image Data

In addition to the cable connections described in the previous sections, you can also exchange data between your camera and computer by reading it directly from the memory card. The Photo Loader software that comes on the bundled CD-ROM disc automatically reads the images from the memory card and stores them in folders on your computer's hard disk.

The following provides general information about how to directly read images from a memory card. Certain details may be different depending on the type of computer you are using.

■ Computer Equipped with a CompactFlash Card Slot

Simply insert the memory card into your computer's CompactFlash card slot.

■ Computer Equipped with a PC Card Slot

For this configuration, you will need to purchase a separately available CASIO PC Card Adapter (CA-10). See the instructions that come with the PC Card Adapter for information about how to use it.

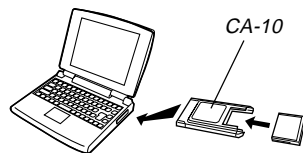

■ Another Computer

To access the contents on the memory card on a computer that does not have a CompactFlash card slot or PC card slot, use a commercially available PC card reader/writer in combination with a separately available CASIO PC Card Adapter (CA-10). See the instructions that come with the PC card reader/writer and the PC Card Adapter for information about how to use them.

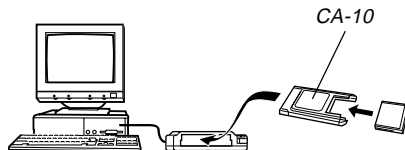

Memory Card Data

Images recorded with this camera and other data are stored on the memory card using DCF (Design rule for Camera File system) protocol. DCF protocol is designed to make it easier to exchange image and other data between digital cameras and other devices.

DCF Protocol

DCF devices (digital cameras, printers, etc.) can exchange images with each other. DCF protocol defines the format for image file data and the directory structure for the memory card, so images can be viewed using another manufacturer's DCF camera or printed on a DCF printer. In addition to support for the DCF protocol, your CASIO digital camera also uses dates in image folder names and image file names, which helps to make data management easier.

Memory Card File Structure

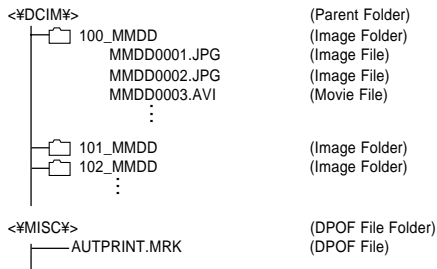

■ Folder and File Contents

- Parent Folder
Contents: All files used by the digital camera
- Image Folder
Contents: Image files recorded by the camera
- Image File
Contents: Still image file recorded by the camera
- Movie File
Contents: Movie file recorded by the camera
- DPOF File Folder
Contents: DPOF files

Image Files Supported by the Camera

- Image files recorded with the CASIO GV-10 Digital Camera
- DCF protocol image files

* Certain DCF functions may not be supported.

* It may take a long time to display an image recorded with another type of camera.

Precautions when Using a Memory Card on a Computer

- When saving memory card contents to a computer hard disk, MO disk, or other medium, be sure to transfer data in DCIM folder units. Changing the name of the DCIM folder to a date or similar type of name is a good way to keep track of multiple DCIM folders. When moving a folder back to the camera's memory card, however, be sure to change its name back to DCIM. This camera does not recognize any folder name besides DCIM.
- The above is also true for the names of folders inside the DCIM folder. These names must be returned to the names assigned to them by the camera whenever you copy the folder back to the memory card for playback on the camera.

- We also strongly recommend that after transferring data from a memory card to other external storage you reformat the memory card and delete its contents before using it to store more images.

Using the Camera as a PC Camera

You can connect your camera to a PC and use it as a PC camera for video conferencing, Web chatting, etc.

IMPORTANT!

- The PC camera mode operation is not supported for the Apple Macintosh.

To connect to a computer

- 1. Install the USB driver onto a computer equipped with a USB port.**
 - If you already installed the USB driver following the procedure under “Transferring Images to a Computer” on page 73, you do not need to install it again here.
 - See the “Bundled Software User’s Manual” for information about installing the driver.
- 2. Select “PC CAMERA” as the camera’s USB mode (page 71).**
- 3. Open the terminal cover and then use the USB cable to connect the camera to the computer.**

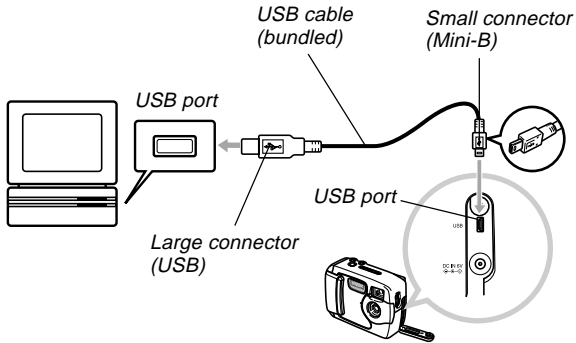

4. Move the POWER ON/OFF switch to ON and then align the dial with PC (PC mode).

- All camera buttons are disabled in the PC mode, including the POWER ON/OFF switch.
- The monitor screen turns off, and the operation lamp lights green.

5. Use the PC camera with the computer for net meeting or some other similar purpose.

6. After you are finished, disconnect the USB cable.

- For details, see “Disconnecting the USB Cable” (page 75).

Other Requirements

You also need to obtain and install video conferencing software in order to use the camera as a PC camera.

Example: Microsoft NetMeeting

In addition, video conferencing also requires network devices such as a modem and terminal adapter, as well as speakers, microphone, etc.

PC Camera Mode Precautions

- This camera is not supplied power from your computer over the USB cable. The camera must be supplied power from its own power supply.
- Make image size and frame rate settings on your computer.
- Use the procedures described in the documentation that comes with your PC camera application to perform PC camera operations.
- See the user documentation that comes with the PC camera application you use for information about whether you can save PC camera still images and movies.

IMPORTANT!

- The PC Camera mode of this camera may not be compatible with certain computers.
- Operation is not guaranteed when the camera is connected to USB hub or expansion USB board.







REFERENCE

SET UP Menu

The following shows the settings available on the SET UP menu.

Item	Settings
DELETE / FORMAT	DELETE ALL / FORMAT
SIZE / QUALITY	1600 x 1200 / SUPER 1280 x 960 / FINE 1280 x 960 / NORMAL 640 x 480 / FINE 640 x 480 / NORMAL
BUZZER	ON / OFF
PRINT ORDER	SELECT IMAGES / ALL IMAGES
DATE	STYLE / CLOCK
OPENING	TYPE1 / TYPE2 / OFF
LANGUAGE	ENGLISH / ESPAÑOL / DEUTSCH / FRANÇAIS / ITALIANO / JAPANESE
USB	NORMAL / PC CAMERA

Troubleshooting

	Problem	Possible Cause	Action
Power	Power does not turn on.	<ol style="list-style-type: none"> 1. Batteries are not oriented correctly. 2. Batteries are dead. 3. Wrong AC adaptor type being used. 	<ol style="list-style-type: none"> 1. Orient batteries correctly (page 30). 2. Replace batteries with a full set of new ones (page 30). 3. Use only an AD-C620/C630 AC adaptor.
	Camera suddenly powers down.	<ol style="list-style-type: none"> 1. Auto Power Function activated (page 37). 2. Batteries are dead. 	<ol style="list-style-type: none"> 1. Turn power back on. 2. Replace batteries with a full set of new ones (page 30).
	 indicator on the monitor screen	Batteries are low.	Replace batteries with a full set of new ones (page 30).
Recording	No recording when the shutter release button is pressed	<ol style="list-style-type: none"> 1. Dial is not set to a recording mode. 2. Flash unit is being charged. 3. The message "MEMORY FULL" is on the monitor screen. 4. No memory card is loaded in the camera. 	<ol style="list-style-type: none"> 1. Set the dial to a recording mode. 2. Wait until flash unit charging finishes. 3. Delete images you no longer need, or use a different memory card. 4. Load a memory card.
	Camera powers down during self-timer countdown.	Batteries are dead.	Replace batteries with a full set of new ones (page 30).
	Monitor screen image is out of focus.	<ol style="list-style-type: none"> 1. Macro mode  being used for scenery or portraits. 2. Normal mode  being used for macro image. 	<ol style="list-style-type: none"> 1. Set the Normal/Macro selector to - (Normal) for scenery and portraits. 2. Set the Normal/Macro selector to  (Macro) for macro images.



REFERENCE

	Problem	Possible Cause	Action
Recording	Recorded images are not saved in memory.	<ol style="list-style-type: none"> 1. Camera powers down before the save operation is complete. 2. Opening of the memory card slot cover before the image save operation is complete. 	<ol style="list-style-type: none"> 1. If the  indicator is on the monitor screen, replace batteries with a full set of new ones as soon as possible. 2. Keep the memory card cover closed until the image save operation is complete.
Playback	Color of the playback image is different from the image on the monitor screen during recording.	<ol style="list-style-type: none"> 1. Sunlight or light from another source is shining directly into the lens during recording. 2. Image quality setting 	<ol style="list-style-type: none"> 1. Position the camera so sunlight does not shine directly into the lens. 2. Change to a higher image quality for recording.
	[+] and [-] operations do not work while the 9-image view is on the monitor screen.	You are operating [+] and [-] while the scroll operation is still being performed.	Wait until image scrolling is complete before pressing [+] or [-].
	Images are not displayed.	A memory card with non-DCF images recorded with another camera is loaded in the camera.	This camera cannot display non-DCF images recorded onto a memory card using another digital camera.
Other	All buttons and switches are disabled.	Circuit problem caused by electrostatic charge, impact, etc. while the camera was connected to another device.	Remove the camera's batteries, disconnect the AC adaptor, replace the batteries, and turn on power again.
	Monitor screen is off.	<ol style="list-style-type: none"> 1. USB cable is connected. 2. Monitor screen is turned off in a recording mode. 	<ol style="list-style-type: none"> 1. After confirming that the computer is not accessing the memory card, disconnect the USB cable. 2. Press DISP to turn on the monitor screen.

REFERENCE

	Problem	Possible Cause	Action
Other	Cannot transfer images or perform PC camera operations after connecting to a computer with the USB cable.	<ol style="list-style-type: none"> 1. Wrong USB mode is selected. 2. USB driver is not installed. 3. Camera is turned off. 	<ol style="list-style-type: none"> 1. Select the USB mode that suits the operation you are trying to perform (page 71). 2. Install the USB driver in accordance with the "Bundled Software User's Manual". 3. Turn on the camera (page 37).

Messages

	Battery power is low.	
NO IMAGES ON THIS MEMORY CARD!	There are currently no images in memory.	DIAL ERROR Indicates that the dial is positioned between two settings (icons). Correctly position the dial at the setting you want to use.
RECORD ERROR	Image data save operation failed. Record the image again.	
DECODE ERROR	<ul style="list-style-type: none"> Image is a format (JPG, AVI) that is not supported by this camera. Image file is corrupted or the file is a type that cannot be displayed by this camera. 	MEMORY FULL CHANGE SIZE / QUALITY OR DELETE UNNEEDED IMAGES. <ul style="list-style-type: none"> No more images can be stored under the current image quality and size settings, but further recording is possible with different settings. Change the image quality and size settings, or delete images you no longer need (page 64). Memory is full. If you want to record more images, delete images you no longer need (page 64). This message also appears after data is transferred to a memory card from a computer when a DCIM folder or other required files (page 77) cannot be created because there is not enough memory card space. Use your computer to free up space by deleting files you no longer need.
DCF ERROR	<p>Indicates that the DCIM folder contains two or more folders with the same serial number (due to using your computer to transfer folders to the memory card, etc.) Use your computer to access the memory card and change folder serial numbers so they are all unique.</p> <p>Example: Folders named 100_1214 and 100_ABCD have the same serial number (100), which will cause this error. Access the card and change the serial number of one of the folders to a three-digit value.</p>	NOT FORMATTED FORMAT → SHUTTER The memory card is not formatted. Format the memory card (page 41).
		 INSERT MEMORY CARD! There is no memory card in the camera. Load a memory card (page 38).

**MEMORY CARD
ERROR!
RESTART CAMERA..
FORMAT IF THIS
MESSAGE APPEARS
AGAIN.,
FORMAT →
SHUTTER**

Some problem occurred with the memory card. Perform the following steps to correct it.

Important!

Performing this procedure deletes all files on the memory card. Before proceeding, try transferring recoverable files to a computer or some other storage device.

1. Press the shutter release button to delete the image.

- Before starting a format operation, connect the AC adaptor for power or load a full set of fresh set of alkaline or lithium batteries. Power interruption during the format operation can result in improper formatting, and even damage the memory card and make it unusable.
 - The message "NO IMAGES ON THIS MEMORY CARD!" appears on the monitor screen after the format operation is complete. This indicates that the format operation was completed successfully.
-

Specifications

Description Digital camera

Model GV-10

Recorded Image

File Format Still images: JPEG (Exif. Ver. 2.1),
DCF standard (Design rule for Camera
File system), DPOF compatible
Movies: AVI (Motion JPEG)

Recording Medium CompactFlash card (Type I)

Recorded Image Size 1600 x 1200 pixels, 1280 x 960 pixels,
640 x 480 pixels

Computer Output Image Size

Image size (pixels)	Quality	File size
1600 x 1200	SUPER	850KB
1280 x 960	FINE	500KB
	NORMAL	350KB
640 x 480	FINE	150KB
	NORMAL	90KB

Movie (320 x 240 pixels)	
Storage Capacity	Approximately 300KB/second
Recording Time	10 seconds per movie

- The above figures are approximations only.

Image Deletion Single image; all images in memory (with image protection)

Effective Pixels 1.23 million

Imaging Element 1/3.2-inch CCD (Total Pixels: 1.31 million)

Lens F2.8; f = 4.6mm (equivalent to 35mm lens for 35mm film)

Zoom Digital zoom: 2X
Image size is 640 x 480 pixels when digital zoom is used.

Focusing Fixed focus with macro mode

Focus Range Normal focus: Approximately 60cm to ∞ (23.6" to ∞)
Macro focus: Approximately 10cm (3.9")

Exposure Control

Light Metering: Center-weighted by CCD
Exposure: Program AE
Exposure
Compensation: -2EV to +2EV (1/3EV units)

Shutter CCD electronic shutter; mechanical shutter, 1 to 1/1500 second

- Aperture** F2.8, F9.7, auto switching
- White Balance** Automatic, fixed (4 modes)
- Self-timer** 10 seconds
- Built-in Flash**
 - Flash Modes: AUTO, OFF, ON
 - Flash Range: Approximately 0.6 to 2 meters (2.0' to 6.6')
- Recording Functions** Normal, continuous shutter, movie, self-timer, macro, Best Shot
- Monitor** 1.6" TFT, color LCD (61,380 pixels, 279 x 220)
- Viewfinder** LCD Monitor or optical viewfinder
- Clock** Built-in quartz digital timepiece for time and date recording and storage with image data; auto calendar up to 2049
- Input/Output Terminals** USB port (Mini-B port), AC adaptor connector
- Power Supply** Four AA-size alkaline or lithium batteries
Four AA-size nickel-metal hydride rechargeable batteries (NP-H3)
AC adaptor (AD-C620/C630)
AC adaptor charger (BC-3HA)

Battery Life

The values noted below indicate the number of hours before battery failure under normal operating temperature (25°C). These values are for reference only, and do not guarantee that any particular set of batteries actually will provide the service life indicated. Low temperatures shorten battery life.

Type of Operation	AA-size Alkaline Batteries LR6	AA-size Lithium Batteries FR6	AA-size Ni-MH Batteries NP-H3
Continuous Playback	240 minutes	370 minutes	220 minutes
Continuous Recording	170 minutes (850 shots)	340 minutes (1700 shots)	170 minutes (850 shots)

- The above figures are approximations only.
- The above guidelines are based on the following battery types:
Alkaline: MX1500 (AA) DURACELL ULTRA
Lithium: Energizer
- Battery life varies with brand.

Continuous recording values show the number of shots without using the flash. The number of shots depends on use of the flash and whether flash is turned on or off.

Power Consumption Approximately 5.2W

Dimensions 100.5(W) x 74.0(H) x 49.0(D) mm
(4.0"(W) x 2.9"(H) x 1.9"(D))

Weight Approximately 250g (8.8oz)
(excluding batteries)

Standard Accessories 8MB CompactFlash memory card, Strap; lens cap; cap holder; USB cable; CD-ROM; four LR6 alkaline batteries; User's Guide (English), Bundled Software User's Manual, Basic Reference (Spanish, German, Portuguese, Chinese, Arabic)

- This camera does not have a separate battery to power its clock. Clock settings are cleared whenever power to the camera is cut off (by batteries going dead while the camera is not connected to an AC power outlet with the AC adaptor) for about 24 hours. After power is resumed, either by loading fresh batteries or connecting to an AC power outlet, you will have to set the correct time and date again.
- The liquid crystal panel built into this camera is the product of precision engineering, with a pixel yield of 99.99%. This also means, however that 0.01% of the pixels can be expected to fail to light or to remain lit at all times.

IMPORTANT!

Please keep your manual and all information handy for future reference.



CASIO ELECTRONICS CO., LTD.
Unit 6, 1000 North Circular Road
London NW2 7JD. U.K.