

CASIO®

EN

Digital Camera

EX-ZR5100

User's Guide

Thank you for purchasing this CASIO product.

- Before using it, be sure to read the precautions contained in this User's Guide.
- Keep the User's Guide in a safe place for future reference.
- For the most up-to-date information about this product, visit the official EXILIM Website at <http://www.exilim.com/>

EXILIM

Accessories

As you unpack your camera, check to make sure that all accessories shown below are included. If anything is missing, contact your original retailer.



Rechargeable lithium ion
battery (NP-130A)

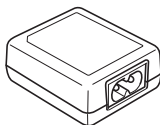

USB-AC adaptor
(AD-C53U)

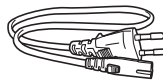

Power cord*



Micro USB cable



Neck strap

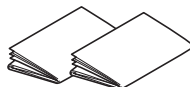

Basic Reference

* The shape of the power cord plug varies according to the country or geographic area where the camera is sold.

- Items actually included depend on the camera model you purchase.

Attaching the Neck Strap to the Camera

1. Undo the strap from the buckle and remove the strap loop **A**.

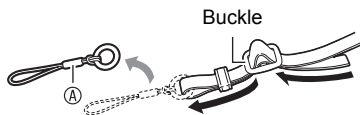

2. Attach the loop on the other end of the strap **B** to the strap hole on one side of the camera, and the loop you removed **A** to the other side.

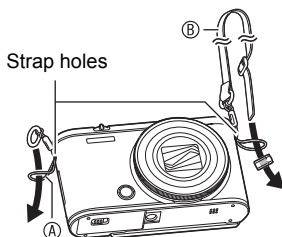

3. Pass the end of the strap through the strap loop ring **A** and secure it with the buckle.

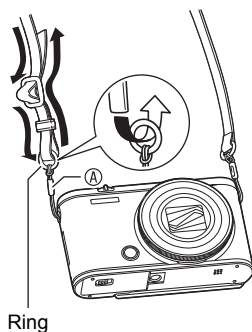

Adjusting the Length of the Strap

You can adjust the length of the strap so it can be used as a neck strap or a shoulder strap.



1. Pull the strap out at the center of the buckle in the direction indicated by ①.

2. Pull the strap in one of the directions indicated by the illustration to adjust the length.

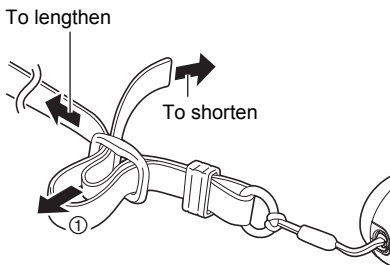

Read this first!

- The contents of this manual are subject to change without notice.
- The contents of this manual have been checked at each step of the production process. Feel free to contact us if you notice anything that is questionable, erroneous, etc.
- Any copying of the contents of this User's Guide, either in part or its entirety, is forbidden. Except for your own personal use, any other use of the contents of this manual without the permission of CASIO COMPUTER CO., LTD. is forbidden under copyright laws.
- CASIO COMPUTER CO., LTD. shall not be held liable for any damages or lost profits suffered by you or any third party due to the use or malfunction of this product.
- CASIO COMPUTER CO., LTD. shall not be held liable for any damages, lost profits, or claims by third parties arising out of the use of the EXILIM Connect application software.
- CASIO COMPUTER CO., LTD. shall not be held liable for any damages or lost profits caused by loss of memory contents due to malfunction, repair, or any other reason.
- Note that the example screens and product illustrations shown in this User's Guide may differ somewhat from the screens and configuration of the actual camera.

LCD Panel

The liquid crystal panel of the monitor screen uses high-precision technology that provides a pixel yield in excess of 99.99%. This means that some very small number of pixels may not light or may remain lit at all times. This is due to the characteristics of the liquid crystal panel, and does not indicate malfunction.

Take test shots

Before shooting your final image, shoot a test shot to ensure that the camera is recording correctly.

Contents

Accessories	2
■ Attaching the Neck Strap to the Camera	3
Read this first!	4

|| General Guide 11

|| Monitor Screen Contents and How to Change Them 13

|| Quick Start Basics 17

What you can do with your CASIO camera	17
Tilting the Monitor Screen	19
First, charge the battery prior to use	21
■ To load the battery	21
■ Charge the Battery	22
Configuring Basic Settings the First Time You Turn On the Camera	26
Turning the Camera On and Off	28
Preparing a Memory Card	29
■ Supported Memory Cards	29
■ To load a memory card	30
■ To format (initialize) a new memory card	31
Using the Menu Screen to Configure Settings	32
Holding the Camera Correctly	33
To shoot a snapshot	34
■ Selecting Premium Auto Pro	34
■ To shoot a snapshot	35
Viewing Snapshots	38
Deleting Snapshots and Movies	39
Snapshot Shooting Precautions	40

|| Snapshot Tutorial 42

Selecting the Recording Mode	42
Using the Control Panel to Configure Camera Settings	44
■ Using the Self-timer (Self-timer)	45
■ Adjusting White Balance (White Balance)	46
■ Selecting a Focus Mode (Focus)	48
■ Specifying ISO Sensitivity (ISO)	50
■ Recording Beautiful Portraits (Make-up)	51
■ Correcting Image Brightness (Exposure)	52
■ Using Flash (Flash)	53
■ Specifying the Metering Mode (Metering)	55
Shooting with Zoom	56
■ Monitor Screen Information when Zooming	57
■ Zooming with Super Resolution (Zoom (SR))	59
■ Expanding the Zoom Range to Shoot Clearer Snapshots . (Multi SR Zoom)	60

Shooting a Burst of Images	(CS) ..	61
■ Shooting with High Speed CS		61
■ Shooting with Prerecord CS		63
■ Using Continuous Shutter with Auto Focus	(AF CS) ..	65
Triggering a Self-timer Operation with Motion	(Motion Shutter) ..	66
■ Configuring Motion Shutter Settings	(Motion Shutter) ..	68
Shooting a Wide View Photo	(Wide View Photo) ..	69
Shooting with Artistic Effects	(Art Shot) ..	71
■ Saving a Second Normal Image		
When Shooting With HDR Art	(Double (HDR Art)) ..	73
Recording Beautiful Images of People and Scenery	(Make-up Art) ..	74
Using the Timer to Shoot a Selfie	(Selfie Timer) ..	75
■ To assign the Selfie Timer to the front shutter button		75
■ To use the Selfie Timer to shoot a selfie		76

Recording Movies

77

To record a movie		77
■ Audio		79
Recording a High Speed Movie		81
Using Prerecord Movie	(Prerecord (Movie)) ..	83
Shooting a Snapshot while Shooting a Movie	(Snapshot In Movie) ..	85
Recording a Movie with a Slow Motion Section ..	(Dramatic Slow Motion) ..	86
■ Configuring Dramatic Slow Motion Settings		87

Using BEST SHOT

89

To shoot with BEST SHOT		91
Creating and Using Your Own Setups	(Custom Shot) ..	93
Recording Beautiful Portraits	(Make-up) ..	94
Shooting Three Versions of an Image with		
Different Skin Tone Settings	(Make-up BKT) ..	95
Shooting with Triple Shot		96
Digitally Correcting for Overexposure and Underexposure	(HDR) ..	97
Shooting a Panorama Image	(Slide Panorama) ..	98
Shooting with a Super Wide Angle of View	(Wide Shot) ..	100
Shooting Multiple Images Over a Specified Period	(Interval Shot) ..	103
Recording a Time Lapse Movie	(Time Lapse) ..	105
Shooting RAW Images	(RAW Image) ..	107
Using a TV Screen to Shoot Snapshots	(HDMI TV Output) ..	108

Using the Menu Screen to Configure Recording Settings	110
■ Shooting a Burst of Images (CS)	111
■ Triggering a Self-timer Operation with Motion (Motion Shutter)	111
■ Assigning a Recording Function to the Front Shutter Button (Front Shutter)	112
■ Assigning Functions to the Function Ring and Control Dial (Key Customize)	113
■ Horizontally Flipping the Recording Image (L/R Flip Shot)	115
■ Using the Self-timer (Self-timer)	115
■ Correcting Image Brightness (Exposure)	115
■ Adjusting White Balance (White Balance)	115
■ Specifying ISO Sensitivity (ISO)	115
■ Specifying the ISO Sensitivity Upper Limit (ISO High Limit)	116
■ Selecting a Focus Mode (Focus)	116
■ Specifying the Auto Focus Area (AF Area)	117
■ Shooting with Face Detection (Face Detection)	118
■ Recording Beautiful Portraits (Make-up)	119
■ Shooting with Continuous Auto Focus (Continuous AF)	119
■ Specifying the Metering Mode (Metering)	119
■ Reducing the Effects of Camera and Subject Movement (Anti-shake Functions)	119
■ To select the snapshot image size (Image Size)	121
■ Specifying Snapshot Image Quality (Image Quality)	122
■ Movie Image Quality Settings (Movie Quality)	123
■ Optimizing Image Brightness (Lighting)	124
■ Controlling Image Sharpness (Sharpness)	124
■ Controlling Color Saturation (Saturation)	124
■ Adjusting Image Contrast (Contrast)	125
■ Specifying Flash Intensity (Flash Intensity)	125
■ Zooming with Super Resolution (Zoom (SR))	125
■ Turning Digital Zoom On or Off (Digital Zoom)	125
■ Using the Auto Focus Assist Light (AF Assist Light)	125
■ Saving a Second Normal Image When Shooting With HDR Art (Double (HDR ART))	126
■ Reducing Wind Noise during Movie Recording (Wind Noise Cut)	126
■ Turning on Image Review (Review)	126
■ Using Icon Help (Icon Help)	127
■ Changing the Monitor Screen when Recording (Shooting Info)	127
■ Configuring Power On Default Settings (Memory)	129

Viewing Snapshots and Movies

Viewing Snapshots	130
Viewing a Movie	130
Viewing a Panorama Image	131
Viewing Continuous Shutter Images	132
■ Deleting CS Images	133
■ Dividing Up an Image Group	134
■ Copying an Image in a Group (Copy)	135
Zooming an On-screen Image	136
Displaying the Image Menu	136

Other Playback Functions (PLAY MENU) 139

Using the Menu Screen to Select a Playback Operation and Configure Settings	139
■ Assigning a Function to the Front Shutter Button (Front Shutter)	139
■ Scrolling Images at High Speed or by Recording Date (Function Ring)	140
■ Creating a Photograph or Movie of Selected Images (Highlight Functions)	140
■ Playing a Slideshow on the Camera (Slideshow)	144
■ Using Snapshots to Create a Movie (Make Movie)	146
■ Editing a Movie on the Camera (Movie Editing)	147
■ To merge two movies (Movie Merge)	149
■ Creating a Snapshot of a Movie Frame (MOTION PRINT)	149
■ Optimizing Image Brightness (Lighting)	150
■ Adjusting White Balance (White Balance)	150
■ Adjusting the Brightness of an Existing Snapshot (Brightness)	151
■ Selecting Images for Printing (DPOF Printing)	151
■ Protecting a File Against Deletion (Protect)	151
■ Protecting an Image in a Group Against Deletion (Protect)	152
■ Editing the Date and Time of an Image (Date/Time)	153
■ Rotating an Image (Rotation)	153
■ Resizing a Snapshot (Resize)	154
■ Cropping a Snapshot (Trimming)	154
■ Copying Files (Copy)	155
■ Combining CS Images into a Single Still Image (CS Multi Print)	155
■ Dividing Up a Group (Divide Group)	156
■ Editing the Images in a Group (Edit Group)	156

Connecting the Camera with a Smartphone (Wireless Connection) 157

Controlling Your Camera with a Smartphone	157
Using a Wireless Mode	160
Getting Ready to Establish a Connection between a Smartphone and Your Camera	162
■ Installing the EXILIM Connect App on Your Smartphone	162
■ Establishing a Wireless Connection for the First Time	163
Using a Smartphone as a Camera Remote Controller (Shoot with phone)	166
Sharing Snapshots with an Unpaired Smartphone (One Time Share)	167
Sending a Snapshot or Movie File from Camera Memory to a Smartphone (Send Selected Image)	169
Viewing Snapshots and Movies in Camera Memory on a Smartphone (View on phone)	170
Sending Images Shot with the Camera to a Phone that is not Paired with It (Send Image)	171

Configuring Wireless Connection Settings	172
■ Entering the Camera's Airplane Mode	(Airplane Mode) .. 172
■ Sending Images from the Camera to a Smartphone as They are Recorded	(Auto Send) .. 173
■ Specifying Images to be Sent by Auto Send	(Auto Send File Settings) .. 175
■ Resizing Snapshots before Sending Them to a Smartphone	(Resize before send) .. 175
■ Add Location Info to Snapshots	(Location info) .. 176
■ Changing the Camera Password for Wireless LAN Connection	(WLAN password) .. 177
■ Unpairing the Camera from a Smartphone	(Unpairing) .. 178

■ Printing 179

Printing Snapshots	179
Using DPOF to Specify Images to be Printed and the Number of Copies	(DPOF Printing) .. 179

■ Using the Camera with a Computer 183

Things you can do using a computer... ..	183
Using the Camera with a Windows Computer	184
■ Viewing and Storing Images on a Computer	184
Using the Camera with a Macintosh	187
■ Connecting the Camera to Your Computer and Saving Files	187
Files and Folders	190
Memory Card Data	191

■ Other Settings (SETTING) 193

Using the Menu Screen to Configure Other Settings	193
■ Enabling Power Saving	(ECO Mode) .. 193
■ Adjusting Monitor Screen Brightness	(Screen) .. 194
■ Configuring Camera Sound Settings	(Sounds) .. 194
■ Creating an Image Storage Folder	(Create Folder) .. 195
■ Time Stamping Snapshots	(Timestamp) .. 195
■ Auto Image Orientation Detection and Rotation	(Auto Rotate) .. 196
■ Specifying the File Name Serial Number Generation Rule	(File No.) .. 196
■ Configuring Sleep State Settings	(Sleep) .. 197
■ Configuring Auto Power Off Settings	(Auto Power Off) .. 197
■ Specifying the Operation when the Monitor Screen is Tilted ..	(Screen Tilt) .. 198
■ Configuring [▶] Setting	(PLAY) .. 198
■ Disabling File Deletion	(Delete Key) .. 198
■ Configuring World Time Settings	(World Time) .. 199
■ Setting the Camera's Clock	(Adjust) .. 200
■ Specifying the Date Style	(Date Style) .. 200
■ Specifying the Display Language	(Language) .. 201
■ Selecting the HDMI Terminal Output Method	(HDMI Output) .. 201
■ Formatting Built-in Memory or a Memory Card	(Format) .. 201
■ Resetting the Camera to Factory Defaults	(Reset) .. 202
■ Checking the Current Camera Firmware Version	(Version) .. 202

Safety Precautions	203
Precautions During Use	211
Power Supply	224
■ Charging	224
■ Battery Precautions	225
■ Using the Camera in another Country	225
Using a Memory Card	226
Reset Initial Default Settings	228
When things don't go right...	231
■ Troubleshooting	231
■ Display Messages	237
Number of Snapshots/Movie Recording Time	239
Specifications	242

General Guide

The numbers in parentheses indicate the pages where each item is explained.

Front

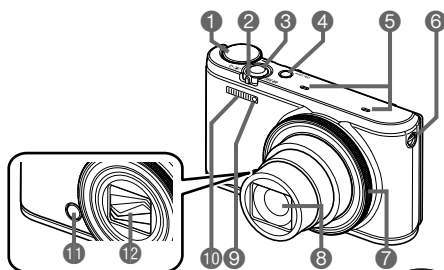

Back

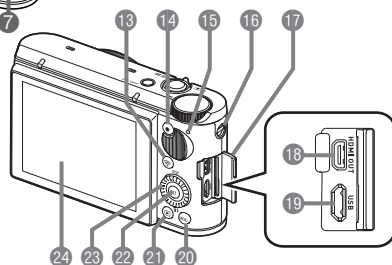

- ① Mode dial (pages 34, 42, 77)
- ② Zoom controller (pages 35, 56, 136)
- ③ Shutter button (pages 28, 34)
- ④ [ON/OFF] (Power) (pages 27, 28)
- ⑤ Microphones (page 79)
- ⑥ Strap hole (page 3)
- ⑦ Function ring (page 140)
- ⑧ Lens
- ⑨ Front lamp (pages 45, 125)
- ⑩ Flash (page 53)
- ⑪ Front shutter button (pages 112, 139)
- ⑫ Lens barrier (page 211)
- ⑬ [Wi-Fi] (Wireless) button (pages 68, 160)
- ⑭ [Movie] (Movie) button (page 77)
- ⑮ Back lamp (pages 23, 24, 28, 35, 53)
- ⑯ Strap hole (page 3)
- ⑰ Terminal cover
- ⑱ [HDMI OUT] HDMI output (micro) (page 108)
- ⑲ [USB] port (pages 22, 24)
- ⑳ [MENU] button (pages 77, 110)
- ㉑ [PLAY] (PLAY) button (pages 28, 38)
- ㉒ [SET] button (pages 44, 77, 110)
- ㉓ Control dial ([▲] [▼] [◀] [▶]) (pages 12, 44, 77, 91, 110, 139)
- ㉔ Monitor screen (pages 13, 34)

Bottom

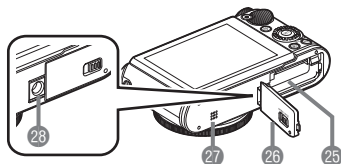

- 25 Battery/memory card slots (pages 21, 30)
- 26 Battery cover
- 27 Speaker
- 28 Tripod hole
Use this hole when attaching to a tripod.

■ Control Dial

With the control dial, you can perform operations by pressing the edges of the dial, and by rotating the dial.

- Depending on the function, certain operations cannot be performed using the control dial.
- In this manual, arrows are used to indicate when the top ([▲]), bottom ([▼]), left ([◀]), or right ([▶]) of the control dial should be pressed.

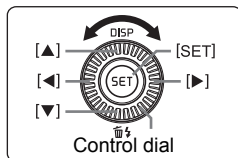

Monitor Screen Contents and How to Change Them

The monitor screen uses various indicators, icons, and values to keep you informed of the camera's status.

- The sample screens in this section are intended to show you the locations of all the indicators and figures that can appear on the monitor screen in various modes. They do not represent screens that actually appear on the camera.

■ Snapshot Recording (1 Shot)

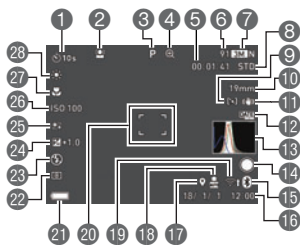

- 1 Self-timer mode (page 45)
- 2 Face Detection (page 118)
- 3 Recording mode (page 42)
- 4 Digital zoom/Zoom (SR) indicator (page 57)
- 5 Remaining movie memory capacity (page 77)
- 6 Remaining snapshot memory capacity (page 239)
- 7 Snapshot image size/Quality (pages 121, 122)
- 8 Movie quality (FHD/STD movie) (pages 77, 123)/
Recording speed (high speed movie) (page 81)
- 9 AF Area (page 117)
- 10 Focal distance (Converted to 35 mm film format.) (page 57)
- 11 Image stabilization (page 119)
- 12 Timestamp indicator (page 195)
- 13 Histogram (page 127)
- 14 Front shutter button function (page 112)
- 15 Bluetooth communication status (page 163)/
Airplane mode (page 172)
- 16 Date/Time (pages 26, 200)
- 17 Location info (page 176)
- 18 Auto Send (page 173)
- 19 Wireless LAN communication status (page 165)
- 20 Focus frame (pages 35, 117)
- 21 Battery level indicator (page 26)
- 22 Metering mode (page 55)
- 23 Flash (page 53)
- 24 Exposure (page 52)
- 25 Make-up (page 51)
- 26 ISO sensitivity (page 50)
- 27 Focus mode (page 48)
- 28 White balance (page 46)

NOTE

- Depending on recording settings, the aperture, shutter speed, and ISO sensitivity values may not appear on the monitor screen. These values will be red if the Auto Exposure (AE) is not correct for some reason.

■ Snapshot Recording (Burst Shooting)

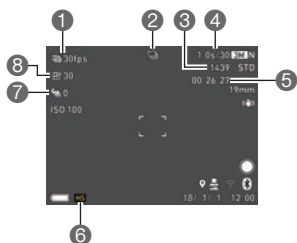

- 1 Continuous Shutter (CS) speed (page 61)
- 2 Recording mode (page 42)
- 3 Remaining snapshot memory capacity (page 239)
- 4 Allowable CS time*/number of CS images (page 61)
* It is not displayed while shooting with Prerecord CS.
- 5 Remaining movie memory capacity (page 240)
- 6 Continuous Shutter mode (page 61)
- 7 Prerecord CS shots (page 63)
- 8 Maximum CS shots (page 61)

■ Movie Recording

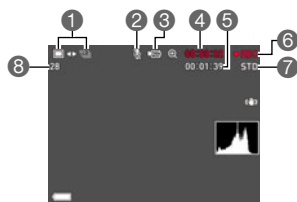

- 1 Snapshot recording mode (Snapshot In Movie) (page 85)
- 2 Audio recording disabled (page 81)
- 3 Recording mode (page 77)
- 4 Movie recording time (page 77)
- 5 Remaining movie memory capacity (page 77)
- 6 Movie recording in progress (page 77)
- 7 Movie quality (FHD/STD movie) (pages 77, 123)/
Recording speed (high speed movie) (page 81)
- 8 Remaining snapshot memory capacity (page 239)

■ Snapshot Viewing

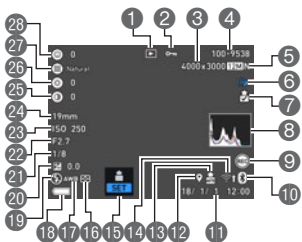

- 1 File type
- 2 Protect indicator (page 151)
- 3 Snapshot image size (page 121)
- 4 Folder name - file name (page 190)
- 5 Snapshot image quality (page 122)
- 6 Recording mode (page 42)
- 7 Image sent (pages 169, 171, 173)
- 8 Histogram (page 127)
- 9 Front shutter button function (page 139)

- 10 Bluetooth communication status (page 163)/
Airplane mode (page 172)
- 11 Date/time (page 200)
- 12 Location info (page 176)
- 13 Auto Send (page 173)
- 14 Wireless LAN communication status (page 165)
- 15 Send Image (page 173)
- 16 Metering mode (page 55)
- 17 White balance (page 150)
- 18 Battery level indicator (page 26)
- 19 Flash (page 53)
- 20 Exposure (page 52)
- 21 Shutter speed
- 22 Aperture value
- 23 ISO sensitivity (page 50)
- 24 Focal distance
(Converted to 35 mm film format.)
- 25 Sculpt (pages 51, 94)
- 26 Face Brightness (pages 51, 94)
- 27 Skin Tone (pages 51, 94)
- 28 Smooth Skin (pages 51, 94)

NOTE

- The folder name and file name in the upper right corner of the monitor screen has the meaning described below (page 190).
Example: 100-0023: 23rd image file in the folder named "100CASIO".

■ Movie Playback



- 1 No audio data available
- 2 Movie recording time (page 130)
- 3 Movie quality (FHD/STD movie) (pages 77, 123)/
Recording speed (high speed movie) (page 81)
- 4 Interval (page 105)
Displayed for movie recorded with Time Lapse.

■ Configuring Monitor Screen Settings

Each press of [▲] (DISP) will cycle through display settings that display or hide on-screen information. You can configure separate settings for the REC mode and PLAY mode.

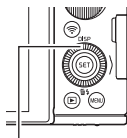

[▲] (DISP)

REC mode

Information on	Displays setting information.
Information off	Hides setting information.

PLAY mode

Information on	Displays settings when shooting and histogram (page 127).
Information off	No information displayed when shooting.

What you can do with your CASIO camera

Your CASIO camera is packed with a powerful selection of features and functions to make recording of digital images easier, including the following main functions.



Make-up Art

This mode is suitable for use outdoors. It enhances the color saturation of scenery to create an artistic effect. A make-up effect is applied to the face of the human subject.

→ See page **74** for more information.

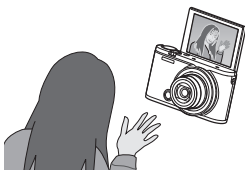

Self-portrait Shooting

The monitor screen can be tilted up to 180 degrees upwards, which allows viewing while shooting self-portraits. Self-portrait shooting is also made simpler by a front shutter button and Motion Shutter feature.

→ See pages **19, 66, 112** for more information.

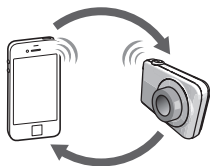

Wireless Connection

Turns your smartphone into a camera remote controller and allows you to send images recorded with your camera to your smartphone.

→ See page **157** for more information.

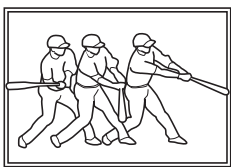

Dramatic Slow Motion

Record lively movement with momentary slow motion to create a dramatic movie.

- The illustration here is for demonstration purposes only.

→ See page **86** for more information.



One Time Share

Share selected snapshots for viewing on smartphones that are not paired with the camera.

The Scene app needs to be installed on the smartphone in order to use One Time Share.

→ See page **167** for more information.

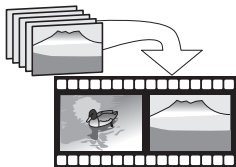

Highlight Movie

You can configure camera settings to automatically select snapshot and movie highlights, and create a movie of them.

→ See page **140** for more information.



Premium Auto Pro

Select Premium Auto Pro recording and the camera automatically determines whether you are shooting a subject or scenery, and other conditions. Premium Auto Pro delivers higher image quality than standard Auto.

→ See page **34** for more information.

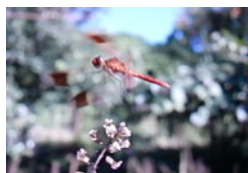

High Speed Movie

Movies can be recorded at up to 1000 frames per second. This makes it possible to clearly view phenomena that are invisible to the human eye, in slow motion.

→ See page **81** for more information.

Tilting the Monitor Screen

The monitor screen can be tilted upwards up to 180 degrees. This means you can position the monitor screen so it faces in the same direction as the lens, for easy composition of self-portraits. You can also tilt the monitor screen upwards 90 degrees, which means you can easily shoot from a low angle without straining your neck to view the monitor screen.

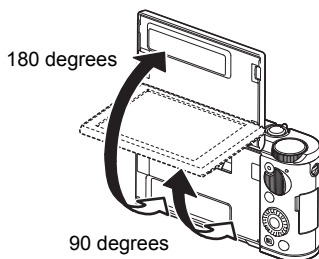

■ What you can do with the camera...

Shoot self-portraits

You can position the monitor screen so it faces in the same direction as the lens, for easy composition of self-portraits.

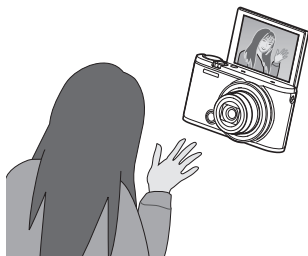

Low-angle shots

The tilt angle of the monitor screen can be adjusted for each composition of images from various low angles.



High-angle shots

By holding the camera upside down, you can angle the monitor screen in a way that allows you to shoot from high angles. In this case, the camera will automatically rotate on-screen information and the displayed image 180 degrees.

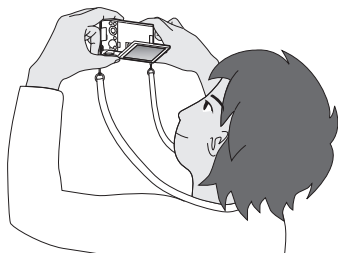

■ Tilting the Monitor Screen

As shown in the figure below, pull upwards on the bottom center of the monitor screen at point **A**.

Keep lifting and it will tilt upwards up to 180 degrees.

- Do not pull downwards from the top of the monitor screen. Be sure to pull upwards from the bottom of the monitor screen as shown in the figure.

OK

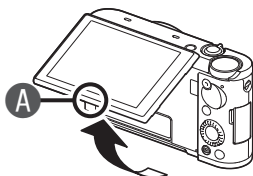

NG

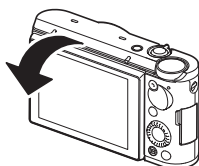

★ IMPORTANT!

- Under factory default settings, the camera will turn on automatically whenever the monitor screen is tilted. See page 198 for information about configuring the camera so it does not turn on when the monitor screen is tilted upwards.
- When returning the monitor screen to the back of the camera, take care so you do not catch your fingers between the top or bottom of the monitor screen and the camera.
- Do not subject the monitor screen to strong impact. Doing so can damage it.

NOTE

- Be sure to return the monitor screen to its normal position to the back of the camera when you are not using it.

■ Returning the Monitor Screen to Its Normal Position

As shown in the figure, holding the monitor screen at point **A**, rotate the screen downwards to the back of the camera.

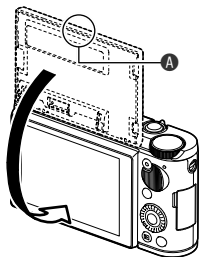

First, charge the battery prior to use.

Note that the battery of a newly purchased camera is not charged. Perform the steps below to load the battery into the camera and charge it.

- Your camera requires a special CASIO rechargeable lithium ion battery (NP-130A) for power. Never try to use any other type of battery.

How to load the battery

1. Open the battery cover.

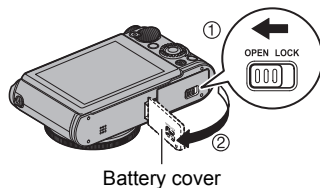

2. Load the battery.

With the CASIO logo on the battery facing downwards (in the direction of the lens), hold the stopper next to the battery in the direction indicated by the arrow as you slide the battery into the camera. Press the battery in until the stopper secures it in place.

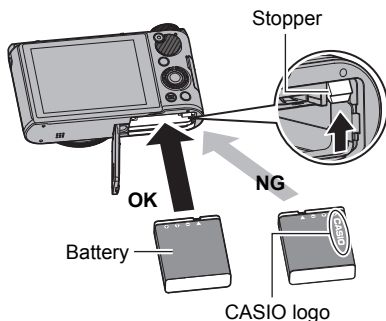

3. Close the battery cover.

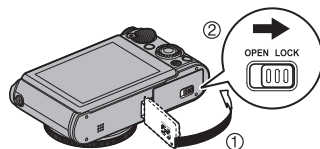

To replace the battery

1. Press [ON/OFF] (Power) to turn off the camera and then open the battery cover.
2. Remove the current battery and load a new one.
3. Close the battery cover.

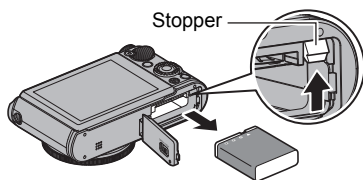

★ IMPORTANT!

- The back lamp (page 11) will flash green for some time after you press [ON/OFF] (Power) to turn off the camera. Never remove the battery while the back lamp is flashing green. Doing so can result in corruption or loss of data in camera memory.

Charge the Battery

You can use either of the two following methods to charge the camera's battery.

- USB-AC adaptor (page 22)
- USB connection to a computer (Using the included micro USB cable.) (page 24)

■ To charge with the USB-AC adaptor

The adaptor lets you charge the battery while it is loaded in the camera. While the camera is turned off, connect in the sequence shown below. Charging time: Approximately 240 minutes

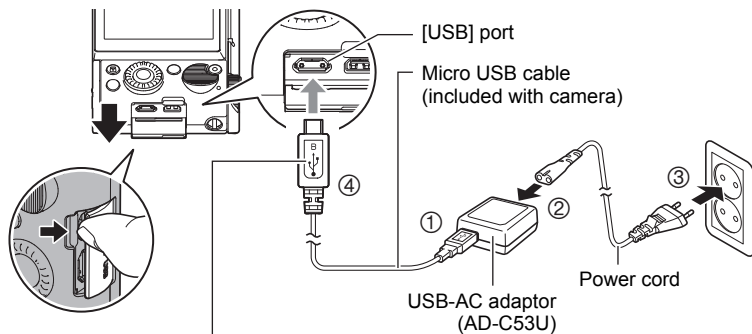

↔ mark of the small (micro USB) connector facing the monitor screen side of the camera.

- When disconnecting the USB-AC adaptor from the camera, be sure to disconnect from the camera first.

Back Lamp Operation

Lamp Status	Description
Lit Red	Charging
Flashing Red	Abnormal ambient temperature, USB-AC adaptor problem, or battery problem (page 224)
Off	Charging complete

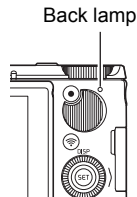

IMPORTANT!

- A battery that has not been used for a long time and/or ambient temperature can cause charging to take longer than normal. These conditions may also cause the back lamp to flash red. If this happens, refer to page 224.
- Make sure that you insert the cable connector into the [USB] port until you feel it click securely into place. Failure to insert the connector fully can result in poor communication or malfunction.
- Note that even while the connector is fully inserted, you still will be able to see the metal part of the connector as shown in the illustration.
- Pressing [ON/OFF] (Power) while the USB-AC adaptor is connected to the camera will turn on the camera with power being supplied by the battery. Because of this, charging will stop.
- The USB-AC adaptor will become warm during charging. This is normal and does not indicate malfunction.
- The shape of the power plug depends on each country or geographic area.

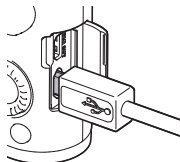

■ To charge using a USB connection to a computer

USB connection lets you charge the battery while it is loaded in the camera. While the camera is turned off, connect in the sequence shown below (①, ②).

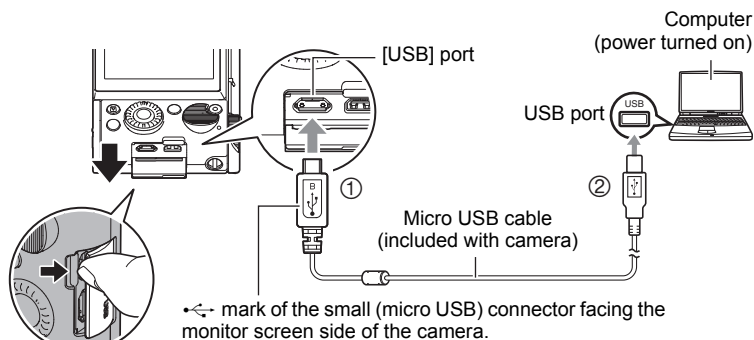

- If the camera is on, press [ON/OFF] (Power) to turn it off before connecting it to your computer.

Back Lamp Operation

Lamp Status	Description
Lit Red, [Lit/Flashing Amber]	Charging
Flashing Red	Abnormal ambient temperature, charging taking abnormally long, or battery problem (page 224)
Off, [Lit Green]	Charging complete

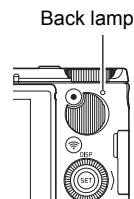

- Lamp statuses in parentheses above indicate operations when the camera is on while charging over a USB connection with a computer.

★ IMPORTANT!

- The first time you connect the camera to your computer with the USB cable, an error message may appear on your computer. If this happens, disconnect and then reconnect the USB cable.
- A battery that has not been used for a long time, certain types of computers, and connection conditions can cause charging to take longer than normal. These conditions may also cause the back lamp to flash red. If this happens, refer to page 224.
- For faster charging, use of the supplied USB-AC adaptor is recommended.
- You cannot use the camera to shoot images while it is being charged over a computer USB connection. If you want to shoot with the camera, disconnect the USB cable.





- If you turn on the camera while charging over a USB connection to a computer is in progress, the camera will establish a USB connection with the computer. Though charging normally should continue at this time, certain types of computers or connection environments may stop charging if supply power is low. This will be indicated by the camera's back lamp lighting green.

Other Charging Precautions

- With the two charging methods described above, you can charge the camera's battery (NP-130A) without removing it from the camera. You also can charge the battery using an optionally available charger unit (BC-130L).
- This model can be charged only from a USB 2.0 specification USB port.
- USB charging devices and power supply devices are subject to fixed standards. Use of an inferior device or a device that is not up to standard can cause malfunction and/or failure of your camera.
- Operation is not guaranteed in the case of a computer built or modified by you. Even in the case of a commercially available computer, certain USB port specifications may make it impossible to charge via the USB cable.
- A battery that is still warm immediately after normal use may not charge fully. Give the battery time to cool before charging it.
- A battery discharges slightly even when it is not loaded in the camera. Because of this, it is recommended that you charge the battery immediately before you need to use it.
- Charging the camera's battery may cause interference with TV and radio reception. If this happens, plug the USB-AC adaptor into an outlet that is further away from the TV or radio.
- Actual charging time depends on current battery capacity and charging conditions.
- Do not use the USB-AC adaptor with any other device.
- Never use the power cord with another device.
- Use only the USB-AC adaptor and USB cable specified in this manual for charging. Use of any other type of devices may result in improper charging.

Checking Remaining Battery Power

As battery power is consumed, a battery indicator on the monitor screen indicates remaining power as shown below.

Remaining Power	High ←————→ Low
Battery Indicator	 →  →  → 
Indicator Color	White → White → Red → Red

 indicates battery power is low. Charge the battery as soon as possible.

Recording is not possible when  is indicated. Charge the battery immediately.

- The level shown by the battery indicator may change when you switch between the REC mode and PLAY mode.
- Leaving the camera for about 20 days with no power supplied while the battery is dead will cause its date and time settings to be cleared. A message telling you to configure time and date settings will appear the next time you turn on the camera after restoring power. When this happens, configure date and time settings (page 200).
- See page 244 for information about battery life and number of shots.

Battery Power Conservation Tips

- Entering the “ECO Mode” (page 193) enables low-power operation. Note that low-power operation decreases monitor screen brightness.
- Enable the Auto Power Off (page 197) and the Sleep (page 197) features to protect against wasting battery power when you forget to turn off the camera.
- Select “Off” for “Continuous AF” (page 119).

Configuring Basic Settings the First Time You Turn On the Camera

The first time you load a battery into the camera, a screen appears for configuring the display language, date, and time settings. Failure to set the date and time correctly will cause the wrong date and time data to be recorded with images.

IMPORTANT!

- A screen for language selection will not appear in step 2 of the procedure below if you purchased a camera intended for the Japanese market. To change the display language from Japanese in this case, use the procedure under “Specifying the Display Language (Language)” (page 201). Note that a version of this manual in the language you select may not be included with a camera intended for the Japanese market.
- Camera models sold in certain geographic areas may not support display language selection.

1. Press [ON/OFF] (Power) to turn on the camera.

2. Use [▲] and [▼] to select the language you want and then press [SET].

3. Use [▲] and [▼] to select a date style and then press [SET].

Example: July 10, 2018

YY/MM/DD → 18/7/10

DD/MM/YY → 10/7/18

MM/DD/YY → 7/10/18

[ON/OFF] (Power)

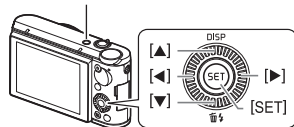

4. Set the date and the time.

Use [◀] and [▶] to select the setting you want to change and then use [▲] and [▼] to change it.

To switch between 12-hour and 24-hour format, use [◀] and [▶] to select “24h” and then use [▲] and [▼] to change the setting.

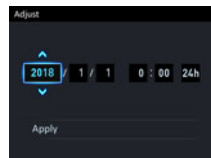

5. After setting the date and time, use [◀] and [▶] to select “Apply” and then press [SET].

If you make a mistake configuring display language, date, or time settings with the above procedure, refer to the following pages for information about how to correct the settings.

- Display language: page 201
- Date and time: page 200

NOTE

- Each country controls its local time offset and the use of summer time, and so they are subject to change.
- Removing the battery from the camera too soon after configuring time and date settings for the first time can cause the settings to be reset to their factory defaults. Do not remove the battery for at least 24 hours after configuring settings.

Turning the Camera On and Off

■ To turn power on

To turn on power and enter the REC mode	Press [ON/OFF] (Power). <ul style="list-style-type: none">• The back lamp will light green momentarily and the lens will extend out of the camera (page 34).• Pressing [▶] (PLAY) while in the REC mode enters the PLAY mode.
To turn on power and enter the PLAY mode	Press [▶] (PLAY). <ul style="list-style-type: none">• The back lamp will light green momentarily and an image currently stored in camera memory will appear on the monitor screen (page 38).• Pressing the shutter button while in the PLAY mode enters the REC mode.

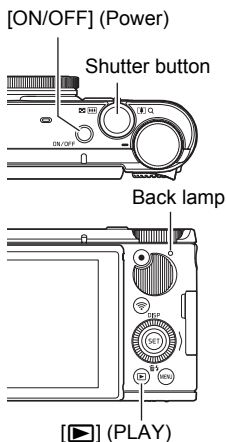

- Take care to ensure that nothing is restricting or coming into contact with the lens as it extends. Holding the lens with your hand so it cannot extend creates the risk of malfunction.
- About 10 seconds after you press [▶] (PLAY) to enter the PLAY mode, the lens will retract into the camera.
- The Sleep function (page 197) or Auto Power Off (page 197) will turn off power automatically if you do not perform any operation for a preset amount of time.
- The camera will not turn on when you press [ON/OFF] (Power) or [▶] (PLAY) while it is being charged over a computer USB connection (page 24).

■ To turn off the camera

Press [ON/OFF] (Power).

NOTE

- Tilting the monitor screen also turns on power (page 198).
- The camera can be configured so power turns off when [▶] (PLAY) is pressed (page 198).

Preparing a Memory Card

Though the camera has built-in memory, its capacity is small. To shoot a large number of images or long movies, you will need to use a commercially available memory card. When no memory card is loaded, images are saved to built-in memory.

- For information about memory card capacities, see page 239.

Supported Memory Cards

Your camera supports use of the following types of SD memory cards.



- SD Memory Card (Up to 2GB)
 - SDHC Memory Card (2GB to 32GB)
 - SDXC Memory Card (32GB to 2TB)
- The above are supported memory card types as of June 2017.
 - Values in parentheses are specification values.
 - Note that the ability to use any particular card with this camera, even if it satisfies the above capacity and type requirements, is not guaranteed.

Memory Card Handling Precautions

Certain types of memory cards can slow down processing speeds. In particular, high-quality movies may not be able to be stored correctly. A slow memory card can take too much time to record data and result in breaks in the image and/or audio during playback. When this happens a yellow “REC” indicator will appear on the monitor screen.

To load a memory card

1. Press [ON/OFF] (Power) to turn off the camera and then open the battery cover.

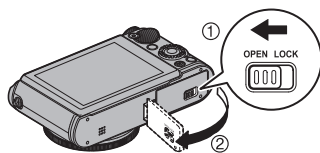

2. Load a memory card.

Positioning the memory card so its back is facing upwards (towards the monitor screen side of the camera), slide it into the card slot all the way in until you hear it click securely into place.

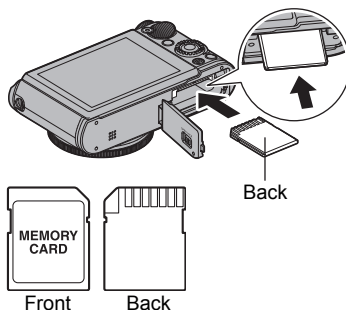

3. Close the battery cover.

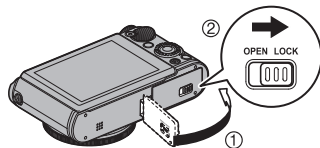

IMPORTANT!

- Never insert anything besides a supported memory card (page 29) into the memory card slot.
- Should water or any foreign object ever get into the card slot, immediately turn off the camera, remove the battery, and contact your retailer or nearest CASIO authorized service center.

To replace the memory card

Press the memory card and then release it. This will cause it to pop out of the memory card slot slightly. Pull the card out the rest of the way and then insert another one.

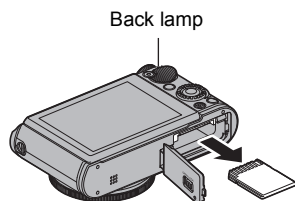

IMPORTANT!

- Turn off the camera before replacing the memory card.
- The back lamp (page 11) will flash green for some time after you press [ON/OFF] (Power) to turn off the camera. Never remove the memory card while the back lamp is flashing green. Doing so can cause the image save operation to fail and even damage the memory card.

To format (initialize) a new memory card

Format a memory card on the camera before using it for the first time.

IMPORTANT!

- Formatting a memory card that already has snapshots or other files on it, will delete its contents. Normally you do not need to format a memory card again. However, if storing to a card has slowed down or if you notice any other abnormality, re-format the card.
- Be sure to use the camera to format a memory card. Formatting a card on a computer will result in a non-SD standard format, which can greatly slow down processing time and cause compatibility, performance, and other problems.

1. Turn on the camera and press [MENU].

2. Press [◀], use [▲] and [▼] to select the “⚙️ SETTING” tab, and then press [▶].

3. Use [▲] and [▼] to select “Format” and then press [▶].

4. Use [▲] and [▼] to select “Format” and then press [SET].

5. Use [▲] and [▼] to select “Yes” and then press [SET].

“⚙️ SETTING” tab

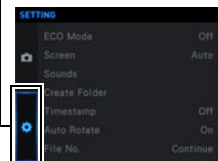

Using the Menu Screen to Configure Settings

The following are menu operations you can use to configure various camera settings. The examples below shows an example menu procedure in the REC mode.

- You also can use the Control Panel (page 44) to configure some of the settings that appear on the menu screen. Refer to the page references provided in this section for information about configuring settings using the Control Panel.

1. In the REC mode, press [MENU].

This will display the menu screen (📷 REC MENU).

- Menu contents are different in the REC mode (📷 REC MENU) and PLAY mode (▶ PLAY MENU).

2. Press [◀], use [▲] and [▼] to select the “📷 REC MENU” tab, and then press [▶] or [SET].

- To configure settings on the “▶ PLAY MENU”, select the “▶ PLAY MENU” tab (which is displayed only in the PLAY mode). To configure other settings, select the “⚙️ SETTING” tab (page 193).

3. Use [▲] and [▼] to select the menu item you want, and then press [▶] or [SET].

- Operating the zoom controller displays the next or previous page of menu items.

4. Use [▲] and [▼] to change the setting of the selected menu item.

5. After the setting is the way you want, press [SET] to apply the setting and return to the viewfinder screen.

- Pressing [MENU] cancels the current selections and returns to the menu screen.
- To continue with configuration of another setting item, press [◀] instead of [SET], move the selection boundary to the next setting item, and then use [▲] and [▼] to change the selected setting. Next, press [▶].
- Pressing the shutter button or [▶] (PLAY) interrupts the menu operation and exits the menu screen.

[▲] [▼] [◀] [▶]

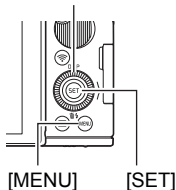

Example:
When “Self-timer” is selected on the “📷 REC MENU” tab

Tabs

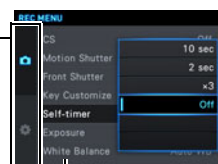

Items

NOTE

- Depending on the recording mode, some of the items on the menu may be dimmed, which indicates they are not available. While Premium Auto Pro is in use, only the menu items whose settings can be configured will be displayed on the menus.

Holding the Camera Correctly

- Your images will not come out clearly if you move the camera when you press the shutter button. Hold the camera and position it correctly as shown in the illustration, with your arms firmly against your sides.
- Holding the camera still, carefully press the shutter button and take care to avoid all movement as the shutter releases and for a few moments after it releases.

This is especially important when available lighting is low, which slows down the shutter speed.

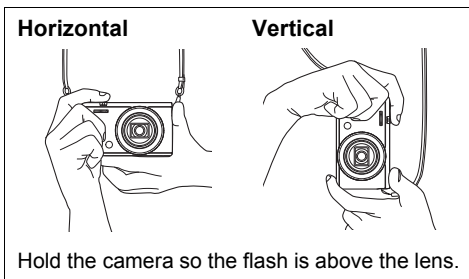

NOTE

- Take care that your fingers and the strap do not cover any of the areas indicated in the illustration.
- To keep the camera from falling, be sure to keep the strap around your neck, wrapped around your wrist, or hanging from your shoulder.
- Never swing the camera around by its strap.
- The supplied strap is intended for use with this camera only. Never use it for any other purpose.
- Shooting an image while the camera's "Auto Rotate" setting is "On" will cause the playback image to be rotated automatically to the orientation the camera was in when the image was recorded (page 196).

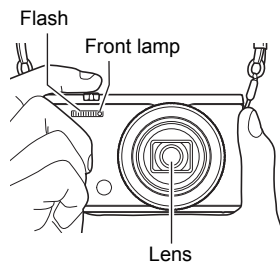



IMPORTANT!

- Take care to ensure that your fingers are not blocking or are not too close to the flash. Fingers can cause unwanted shadows when using the flash.

To shoot a snapshot

Selecting Premium Auto Pro

Recording Mode	REC Screen Icon Display	Description
 Premium Auto Pro		<p>Configures optimal settings to match the shooting environment and performs high-speed image processing for better looking images. When shooting against backlighting, at night, with zoom, and under other difficult conditions, the camera will automatically shoot a burst of images and combine them into a final image.</p> <ul style="list-style-type: none">• Compared with the standard Program Auto Mode (page 42), the conditions below apply while shooting with Premium Auto Pro.<ul style="list-style-type: none">– Shooting settings that can be changed are limited.– Battery life may be somewhat shorter.

1. Press [ON/OFF] (Power) to turn on the camera.

The camera will enter the REC mode.

- If the camera is in the PLAY mode, press the shutter button.

2. Align the mode dial with [] (Premium Auto Pro).

Remaining Snapshot Memory Capacity (page 239)



Premium Auto Pro

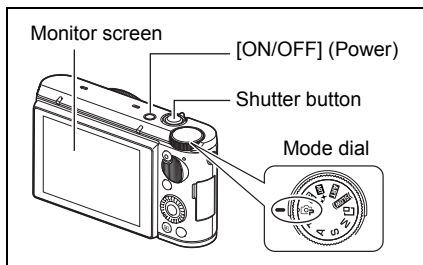

To shoot a snapshot

1. Point the camera at the subject.

The camera will automatically decide where the focus area should be and display focus frames accordingly.

- If you are shooting with Premium Auto Pro, text will appear at the bottom of the monitor screen describing the type of shot the camera has detected.
- You can zoom the image, if you want.

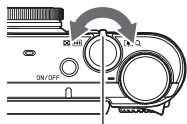

Zoom controller

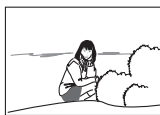

Wide Angle



Telephoto



Appears when the camera detects it is stationary on a tripod.



If the camera judges that CS shooting is required when shooting with Premium Auto Pro, it will automatically switch to an HS scene, and “HS” will appear on the monitor screen. With the HS scene, the camera will shoot a burst of images and combine them to form the final image. To avoid image blur, make sure that the camera and subject remain still until all of the images are shot.

2. Half-press the shutter button to focus the image.

When focusing is complete, the camera will beep, and the focus frame and the back lamp will light green.

Back lamp

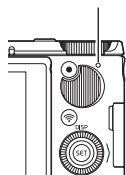

Focus frame

Half-press

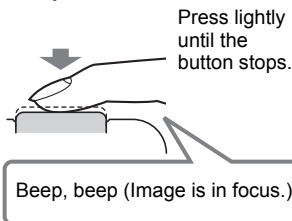

When you half-press the shutter button, the camera automatically adjusts exposure and focuses on the subject it is currently pointed at. Mastering how much pressure is required for a half-press and a full-press of the shutter button is an important technique for good-looking images.

3. Continuing to keep the camera still, press the shutter button the rest of the way down.

This records the snapshot.

- You can also record by pressing the front shutter button (page 11). First you need to assign a recording function to the front shutter button using the “Front Shutter” menu item (page 112).

Full-press

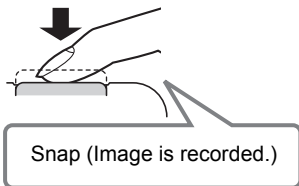

Recording a Movie

Press [●] (Movie) to start movie recording.

Press [●] (Movie) again to stop movie recording.

See the following pages for details.

Standard movie (STD movie): page 77

High-definition movie (FHD movie): page 77

High speed movie (HS movie): page 81

[●] (Movie)

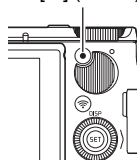

■ If the image does not focus...

If the focus frame stays red and the back lamp is flashing green, it means that the image is not in focus (because the subject is too close, etc.). Re-point the camera at the subject and try to focus again.

■ Shooting with Premium Auto Pro

- Some menu items are not available while Premium Auto Pro is in use. Only the menu items whose settings can be configured will be displayed on the menus while Premium Auto Pro is in use.
- Shutter speed, aperture, ISO sensitivity, and the functions below are optimized by Premium Auto Pro.
 - Continuous AF (page 119)
 - Face Detection (page 118)
 - HS Scene Shooting (page 35)
- Shooting with Premium Auto Pro can cause vibration and noise to occur due to lens operation. This does not indicate malfunction.
- The message “Processing Premium Auto. Please wait...” may appear on the monitor screen. If you feel the camera is taking too long to process data, try shooting with Program Auto (page 42) instead.
- The shutter button is disabled and will not record while the message “Processing Premium Auto. Please wait...” is displayed. The message will not appear if “Type 2, Type 3” or “Off” is selected for the Review setting (page 126).
- In some cases, Premium Auto Pro may not be able to interpret the shooting environment correctly. If this happens, shoot with Program Auto (page 42).
- If “[HS]” is displayed, the camera will shoot a series of CS images and merge them into a final image. If you do not want to shoot CS images, select “Off” for the Control Panel (page 44) “HS Scene Shooting” item.
- Certain flash settings (page 53) can limit environmental factors detectable.

Viewing Snapshots

Use the following procedure to view snapshots on the camera's monitor screen.

- For information about how to play back movies, see page 130.
- For information about images recorded using continuous shutter (CS), see page 132.

1. Turn on the camera and press **[▶] (PLAY)** to enter the **PLAY mode**.

- This causes an image to appear on the monitor screen.
- Information about the displayed snapshot also is included (page 15).
- You also can clear the information to view only the snapshot (page 16).
- You can zoom in on the image by rotating the zoom controller towards **[▲]** (page 136). If you are recording a snapshot that is very important to you, it is recommended that you zoom the image and check its details after recording it.



[▶] (PLAY)

2. Use **[◀]** and **[▶]** to scroll between images.

- Holding down either button scrolls at high speed.



NOTE

- Half-pressing the shutter button while in the PLAY mode or while a menu screen is displayed will switch directly to the REC mode.



Deleting Snapshots and Movies

If memory becomes full, you can delete snapshots and movies you no longer need in order to free up storage and record more images.

IMPORTANT!

- Remember that a file (image) delete operation cannot be undone.
- For information about images recorded using continuous shutter (CS), see page 133.
- You can protect images against being unintentionally deleted, if you want (page 198).

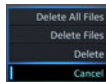

■ To delete a single file

1. Press **[▶]** (PLAY) to enter the PLAY mode and then press **[▼]** ( ).
2. Use **[◀]** and **[▶]** to scroll through the files until the one you want to delete is displayed.



3. Use **[▲]** and **[▼]** to select “Delete” and then press **[SET]**.
 - To delete other files, repeat steps 2 and 3.
 - To exit the delete operation, press **[MENU]**.
 - If a CS group (page 132) or interval shot group (page 132) is displayed when you perform the above procedure, all of the images in the currently displayed group will be deleted.

■ To delete specific files

1. Press **[▶]** (PLAY) to enter the PLAY mode and then press **[▼]** ( ).
2. Use **[▲]** and **[▼]** to select “Delete Files” and then press **[SET]**.
This displays a file selection screen.
3. Use **[▲]**, **[▼]**, **[◀]**, and **[▶]** to move the selection boundary to the file you want to delete, and then press **[SET]**.
This will select the check box in the lower left corner of the selected file's image and move the blue boundary to the next image.
 - To clear (deselect) a check box, move the blue boundary to the applicable file and then press **[SET]**.
 - You can enlarge the selected image before deleting it by rotating the zoom controller towards **[⬆]** ().
4. Repeat step 3 to select other files, if you want. After you are finished selecting files, press **[MENU]**.

5. Use [▲] and [▼] to select “Yes” and then press [SET].

- This deletes the files you selected.
- To cancel the delete operation, select “No” in step 5 and then press [SET].

■ To delete all files

1. Press [▶] (PLAY) to enter the PLAY mode and then press [▼] (🗑️ ⚡).

2. Use [▲] and [▼] to select “Delete All Files” and then press [SET].

3. Use [▲] and [▼] to select “Yes” and then press [SET] to delete all files.

This will cause the message “There are no files.” to appear.

Snapshot Shooting Precautions

Operation

- Never open the battery cover while the back lamp is flashing green. Doing so can result in the image you just shot being saved incorrectly, damage to other images stored in memory, malfunction of the camera, etc.
- If unwanted light is shining directly onto the lens, shade the lens using your hand, etc. when shooting.

Monitor Screen when Shooting Snapshots

- Subject brightness conditions can cause monitor screen response to slow and can cause digital noise in the monitor screen image.
- The image that appears on the monitor screen is for image composition. The actual image will be recorded at the quality set for the image quality setting (page 122).

Shooting Indoors under Fluorescent Lighting

- Minute flickering of fluorescent lighting can affect the brightness or color of an image.

Other Precautions

- The slower the shutter speed, the greater the possibility that noticeable noise will be generated in an image. Because of this, the camera automatically performs a noise reduction at slow shutter speeds. The noise reduction process causes it to take longer to record images at lower shutter speeds. The shutter speeds for which noise reduction is performed depend on the camera setup and shooting conditions.
- A noise reduction process is performed when ISO sensitivity is set to a high value. This can cause the camera to take relatively longer to be ready to shoot again after you press the shutter button. Do not perform any key operation while the image recording operation is in progress.
- Due to the characteristics of the imaging element used by the camera, very fast moving objects in an image may appear distorted.

■ Auto Focus Restrictions

- Any of the following can make proper focus impossible.
 - Solid color wall or other very low contrast subject
 - Strongly back lit subject
 - Very shiny subject
 - Blinds or other subject with a repeating horizontal pattern
 - Multiple subjects at varying distances from the camera
 - Subject in a dark location
 - Subject that is too far away for light from the AF assist light to reach
 - Camera movement while shooting
 - Fast-moving subject
 - Subjects outside the focus range of the camera

Selecting the Recording Mode

Your camera has a variety of different recording modes. Before recording an image, rotate the mode dial to select the recording mode that suits the type of image you are trying to record.

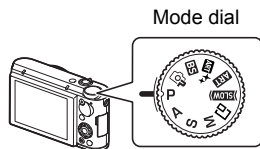

P Program Auto	Standard Auto recording mode. This is the mode you normally should use.
GA Premium Auto Pro	With Premium Auto Pro recording, the camera automatically determines whether you are shooting a subject or scenery, and other conditions. Premium Auto Pro recording delivers higher image quality than standard Auto recording (page 34).
BS BEST SHOT	Simply select one of a collection of built-in sample scenes and the camera sets up automatically for beautiful images every time (page 91).
ART +- Make-up Art	It enhances the color saturation of scenery to create an artistic effect. A make-up effect is applied to the face of the human subject (page 74).
ART Art Shot	A variety of artistic effects help to make even common, ordinary subjects become more novel and exciting (page 71).
SL SLOW Dramatic Slow Motion	Record lively movement with momentary slow motion to create a dramatic movie (page 86).
Wide View Photo	Single operation stores a super-wide angle image, an enlarged extract from the super-wide angle image and a wide view photo movie (page 69).

M M (Manual Exposure) mode

This mode gives you total control over aperture and shutter speed settings.

- ① Press [SET] to open the Control Panel (page 44).
- ② Use [▲] and [▼] to select **A** (Aperture), and then press [SET].
- ③ Use [▲] and [▼] to change the aperture setting, and then press [◀].
- ④ Use [▲] and [▼] to select **S** (Shutter Speed), and then press [SET].
- ⑤ Use [▲] and [▼] to change the shutter speed setting, and then press [SET].

S S (Shutter Speed AE) mode

In this mode, you select the shutter speed and other settings are adjusted accordingly.

- ① Press [SET] to open the Control Panel (page 44).
 - ② Use [▲] and [▼] to select **S** (Shutter Speed), and then press [SET].
 - ③ Use [▲] and [▼] to change the shutter speed setting, and then press [SET].
- You also can select the EV shift setting located under the shutter speed setting and then specify an exposure value (Exposure), if you want.

A A (Aperture AE) mode

In this mode, you select the aperture and other settings are adjusted accordingly.

- ① Press [SET] to open the Control Panel (page 44).
 - ② Use [▲] and [▼] to select **A** (Aperture), and then press [SET].
 - ③ Use [▲] and [▼] to change the aperture setting, and then press [SET].
- You also can select the EV shift setting located under the aperture setting and then specify an exposure value (Exposure), if you want.



IMPORTANT!

- If you cannot focus properly with Program Auto, try using focus lock (page 49) or Manual Focus (page 48).
- In the S mode, ISO sensitivity (page 50) always operates according to its “Auto” setting. The ISO sensitivity setting cannot be changed while in the S mode.
- The flash **FA** (Auto Flash) and **RE** (Red Eye Reduction) flash modes are not supported while A, S, or M is selected for the recording mode. If you want the flash to fire, select **FO** (Flash On) as the flash mode.
- The displayed ISO sensitivity, shutter speed or aperture value will turn red when you half-press the shutter button if the image is overexposed or underexposed.

Using the Control Panel to Configure Camera Settings

The Control Panel can be used to configure camera settings.

1. In the REC mode, press [SET].

2. Use [▲] and [▼] to select the setting item you want to change, and then press [SET] or [▶].

This will select one of the Control Panel icons and display its settings.*

- 1 Self-timer (page 45)
- 2 White balance (page 46)
- 3 Focus (page 48)
- 4 ISO sensitivity (page 50)
- 5 Make-up (page 51)
- 6 Exposure (page 52)
- 7 Flash (page 53)
- 8 Metering (page 55)

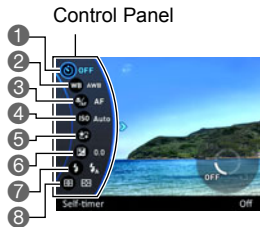

Example: Configuring Program Auto settings

* Items displayed in the Control Panel depend on the recording mode.

3. Use [▲] and [▼] to change the setting.

4. After the setting is the way you want, press [SET].

This will apply the setting and return to the REC mode.



NOTE



- You also can use on-screen menus to configure settings other than those listed above (page 110).

Using the Self-timer (Self-timer)

With the Self-timer, pressing the shutter button starts a timer. The shutter is released and the image is shot after a fixed amount of time.

1. Select the  (Self-timer) Control Panel option.

2. Select the setting you want and then press [SET].

Setting	REC Screen Icon Display	Description
10s 10 sec		10-second Self-timer
2s 2 sec		2-second Self-timer <ul style="list-style-type: none">When shooting under conditions that slow down the shutter speed, you can use this setting to prevent image blur due to camera movement.
x3 x3 (Triple Self-timer)		Shoots three images: one image 10 seconds after the shutter button is pressed, and the next two images as soon as the camera is ready after shooting the previous image. How long it takes for the camera to get ready to shoot depends on the image size and quality settings, whether or not a memory card is loaded in the camera, and the flash charge condition.
OFF Off	None	Turns off the Self-timer.

- The front lamp flashes while the Self-timer countdown is in progress.
- You can interrupt an ongoing Self-timer countdown by pressing [SET].

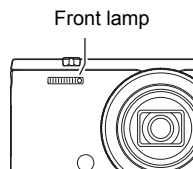















NOTE

- The Self-timer cannot be used together with the following features.
High Speed CS with Prerecord CS, Prerecord (Movie), Slide Panorama, Wide Shot, Triple Shot
- The Triple Self-timer cannot be used together with the following features.
Movie, Time Lapse, High Speed CS, Multi SR Zoom, HS Night Shot, All-In-Focus Macro, Wide View Photo, Interval Shot
- The Motion Shutter (page 66) can be used only while the Control Panel's self-timer setting is "Off".

Adjusting White Balance (White Balance)

You can adjust white balance to match the source of light available where you are shooting and avoid the blue cast that results when shooting outdoors when it is cloudy, and the green cast that results when shooting under fluorescent lighting.

1. Select the  (White Balance) Control Panel option.
2. Select the shooting condition you want and then press [SET].
 - You can also perform this operation using the function ring.

Setting	REC Screen Icon Display	Description
 Auto WB	None	Configures the camera to adjust white balance automatically.
 Daylight		For shooting outdoors on a clear day
 Overcast		For shooting outdoors on an overcast rainy day, in the shade, etc.
 Shade		For shooting on a clear day in the shade of trees or buildings
 Day White Fluor		For shooting under white or day white fluorescent lighting
 Daylight Fluor		For shooting under daylight fluorescent lighting
 Tungsten		For shooting under light bulb lighting

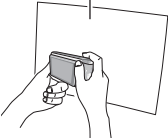
Setting	REC Screen Icon Display	Description
MWB Manual WB		<p>For configuring the camera manually to suit a particular light source</p> <ol style="list-style-type: none"> ① Select "Manual WB". ② Under the lighting conditions you plan to use when shooting, point the camera at a blank white piece of paper so it fills the entire monitor screen and then press the shutter button. ③ Press [SET]. <p>The white balance setting is retained even if you turn off the camera.</p> <div style="text-align: right;"> <p>Blank white paper</p>  </div>





- When "**AWB** Auto WB" is selected for the white balance setting, the camera automatically determines the white point of the subject. Certain subject colors and light source conditions can cause problems when the camera tries to determine the white point, which makes proper white balance adjustment impossible. If this happens, select the white balance setting that matches your shooting conditions (Daylight, Overcast, etc.).

Selecting a Focus Mode (Focus)

- Auto Focus is the only focus mode available while Make-up (page 51) or Face Detection (page 118) is enabled. To select another focus mode, first turn off Make-up and Face Detection.

1. Select the  (Focus) Control Panel option.

2. Select the setting you want and then press [SET].

Settings	REC Screen Icon Display	Type of Shot	Focus Mode		Approximate Focus Range*1	
			Snapshot	Movies	Snapshot	Movies
 AF (Auto Focus)	None	General recording	Automatic	Automatic*3	3 cm to ∞ (infinity) (1.2" to ∞) (Wide Angle)*2	
 Macro		Close ups				
 MF (Manual Focus)		When you want to focus manually	Manual		3 cm to ∞ (infinity) (1.2" to ∞) (Wide Angle)*2	

*1 The focus range is the distance from the lens surface.

*2 The focus range depends on the current optical zoom position.

*3 During High Speed Movie recording, focus is fixed at the position where it was when recording started. To focus an image, half-press the shutter button for Auto Focus or focus manually before you press [●] (Movie) to start recording.

To focus with manual focus

1. On the monitor screen, compose the image so the subject you want to focus on is within the yellow boundary.

2. Watching the image on the monitor screen use [◀] (nearer) and [▶] (further) to adjust focus.

- At this time the image that is within the boundary will enlarge and fill the monitor screen, which aids in focusing. Pressing [SET] will return to the screen in step 1.
- When the Key Customize "Function Ring" setting (page 113) is set to "MF" (Manual Focus), you can use the function ring for focusing.

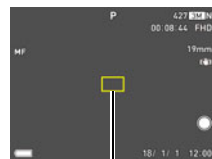

Yellow boundary

NOTE

- An Auto Macro feature detects how far the subject is from the lens and automatically selects either Macro Focus or Auto Focus accordingly.
- Use of the flash together with Macro Focus can cause the light of the flash to become blocked, which may result in unwanted lens shadows in your image.
- Whenever you perform an optical zoom operation while shooting with Auto Focus, Macro Focus, or Manual Focus, a value will appear on the monitor screen to tell you the focus range, as shown below. Note that the focus range is displayed including the Auto Macro range only when shooting with Auto Focus.



Example: ○○* cm - ∞

* ○○ is the actual focusing range value.

- The operations assigned to the [◀] and [▶] keys with the “L/R Key” setting (page 113) are disabled while Manual Focus is selected as the focus mode.

Using Focus Lock

“Focus lock” is a technique you can use when you want to compose an image in which the subject you want to focus on is not within the focus frame in the center of the screen.

- To use focus lock, select “[] Spot” or “[] Tracking” for the Auto Focus area (page 117).

1. Align the monitor screen’s focus frame with the subject you want to focus on and then half-press the shutter button.

Subject to be focused on

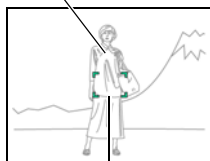

Focus frame

2. Keeping the shutter button half-pressed (which maintains the focus setting), move the camera to compose the image.

- When “[] Tracking” is selected as the Auto Focus area, the focus frame will move automatically and follow the subject.



3. When you are ready to shoot the image, press the shutter button the rest of the way down.

NOTE

- Focus lock also locks exposure (AE).

Specifying ISO Sensitivity (ISO)

ISO sensitivity is a measure of sensitivity to light.

1. Select the  (ISO Sensitivity) Control Panel option.

2. Select the setting you want and then press [SET].

Setting	REC Screen Icon Display	Description			
Auto	None	Adjusts sensitivity automatically according to conditions.			
ISO80	ISO 80	Lower sensitivity ↑ ↓ Higher sensitivity	Slow shutter speed	Less noise	
ISO100	ISO 100		↑ ↓	Fast shutter speed (Set for shooting in dimly lit areas.)	Some coarseness (increased digital noise)
ISO200	ISO 200				
ISO400	ISO 400				
ISO800	ISO 800				
ISO1600	ISO 1600				
ISO3200	ISO 3200				
ISO6400	ISO 6400				

NOTE

- While "Auto" is selected, Anti Shake corrects for subject movement only (page 119).
- Since higher ISO sensitivity values tend to result in digital noise in images, the camera performs a noise filtering process. Because of this, it may take relatively longer for the camera to finish recording an image after it is shot. You will not be able to perform any key operation while image recording is in progress.
- In the S (Shutter Speed AE) mode, ISO sensitivity always operates according to its "Auto" setting.
- In the M (Manual Exposure) mode, "Auto" cannot be selected.

Recording Beautiful Portraits (Make-up)

Make-up enables adjustment of human skin tone hues and texture, and softening of facial shadows caused by harsh sunlight for better looking portraits. Make-up can be used with the recording modes listed below.

- Program Auto
- Premium Auto Pro
- Make-up Art
- Some BEST SHOT scenes
- Make-up BKT

1. Select the  (Make-up) Control Panel option, and then press [SET].

2. Select the setting you want, and then change the setting value.

① Smooth Skin	Adjusts skin smoothness.
② Skin Tone	Adjusts the complexion setting.
③ Face Brightness	Adjusts face brightness.
④ Sculpt	Adjusts detail enhancement.



NOTE

- The settings below become configured automatically whenever the “Smooth Skin”, “Face Brightness”, or “Sculpt” setting is something other than “0”, or when the “Skin Tone” setting is something other than “Natural”.
 - Face Detection: On
 - Focus Mode: AF (Auto Focus)
- Make-up cannot be used with the following functions.
Some BEST SHOT scenes, Art Shot, High Speed CS, Time Lapse, Interval Shot

Correcting Image Brightness (Exposure)

You can manually adjust an image's exposure value (EV value) before shooting it.

- Exposure Compensation Range: -2.0 EV to +2.0 EV
- Unit: 1/3EV

1. Select the (Exposure) Control Panel option.

2. Adjust the exposure compensation value.

- You can also perform this operation using the function ring.

, clockwise:

Increases the EV value. A higher EV value is best for light-colored subjects and backlit subjects.

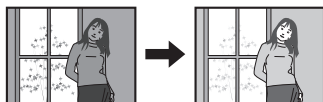

, counterclockwise:

Decreases the EV value. A lower EV value is best for dark-color subjects and for shooting outdoors on a clear day.

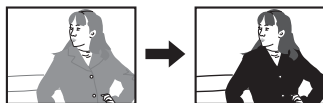

To cancel exposure compensation, change the Exposure value to 0.0.

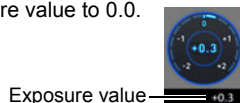

3. Press [SET].

This applies the exposure compensation value. The exposure compensation value you set remains in effect until you change it or turn off the camera (which causes it to revert to "0.0").

NOTE

- When shooting under very dark or very bright conditions, you may not be able to obtain satisfactory results even after performing exposure compensation.

Using Flash (Flash)

1. In the REC mode, press [▼] (🗑️ ⚡) to select the flash setting you want.

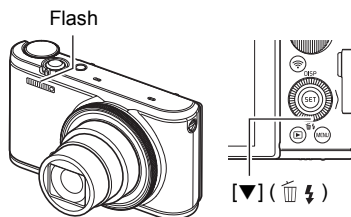

Setting	REC Screen Icon Display	Description
🗑️ Auto Flash	None	Flash fires automatically in accordance with exposure (amount of light and brightness) conditions.
🗑️ Flash Off		Flash does not fire.
⚡ Flash On		Flash always fires. This setting can be used to brighten a subject that normally comes out dark due to daylight or backlight (daylight synchro flash).
👁️ Red Eye Reduction		Flash fires automatically. This type of flash can be used to reduce the chance of redness in the subject's eyes.

2. Press the shutter button to shoot.

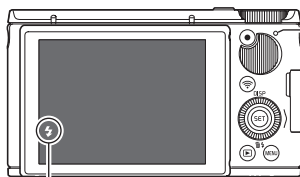

Back lamp

Flashes amber while the flash is charging to indicate that image recording is disabled.

- You will not be able to take another flash snapshot until the lamp stops flashing amber, which indicates that charging is complete.

⚡ indicates the flash will fire.





- For information about Flash Range, see page 243.



IMPORTANT!

- Foreign matter on the flash window can react with the light of the flash, producing some smoke and abnormal odor. Though this does not indicate malfunction, oil from your fingers and other foreign matter when left on the flash window can become difficult to clean off later. Because of this, you should make it a regular habit to wipe the window clean regularly with a soft, dry cloth.

NOTE

- Take care so your fingers and the strap do not block the flash.
- The desired effect may not be obtained when the subject is too far away or too close.
- Flash charging time (page 243) depends on operating conditions (battery condition, ambient temperature, etc.).
- Shooting with flash turned off when lighting is dim results in a slow shutter speed, which can cause image blur due to camera movement. Under such conditions, secure the camera with a tripod, etc.
- With red eye reduction, the flash is fired automatically in accordance with exposure. It does not fire in areas where lighting is bright.
- The presence of outdoor sunlight, fluorescent lighting, or some other light source can cause abnormal image colors.
- Select  (Flash Off) for the flash setting when shooting in areas where flash photography is prohibited.
- The flash  (Auto Flash) and  (Red Eye Reduction) flash modes are not supported while A, S, or M is selected for the recording mode. If you want the flash to fire, select  (Flash On) as the flash mode.

Red-eye Reduction

Using the flash to shoot at night or in a dimly lit room can cause red spots inside the eyes of people who are in the image. This is caused when the light from the flash reflects off of the retina of the eye. When red-eye reduction is selected as the flash mode, the camera fires a pre-flash to cause the irises in the eyes of any people in the image to close, which reduces the chance of red eye.

Note the following important points when using red-eye reduction.





- Red-eye reduction does not work unless the people in the image are looking directly at the camera (flash).
- Red-eye reduction may not work very well if the subjects are located far away from the camera.

Specifying the Metering Mode (Metering)

The metering mode determines what part of the subject is metered for exposure.

1. Select the  (Metering) Control Panel option.

2. Select the setting you want and then press [SET].

Setting	REC Screen Icon Display	Description
 Multi	None	Multi-pattern metering divides the image into sections and measures the light in each section for a balanced exposure reading. This type of metering provides error-free exposure settings for a wide range of shooting conditions.
 Center Weighted		Center weighted metering concentrates on the center of the focus area to measure light. This type of metering is best when you want some level of control over contrast.
 Spot		Spot metering takes readings at a very small area. Use this metering method when you want exposure to be set according to the brightness of a particular subject, without being affected by surrounding conditions.

Shooting with Zoom

Your camera supports the zoom operations described below.

Optical zoom	Zooming is performed by changing the lens focal distance, so there is no deterioration of image quality.
HD Zoom	Allows greater zoom capabilities by cutting out a portion of the original image and enlarging it, without deterioration of image quality.
Single SR Zoom	Applies super resolution technology to suppress image deterioration (page 59).
Multi SR Zoom	Shoots a burst of high-speed images, which are then combined into a final image in a way that lessens deterioration of image quality. Multi SR Zoom is enabled only when the "Multi SR Zoom" BEST SHOT scene is selected. (page 60)
Digital zoom	A digital process is used to enlarge the center of the image, so there is deterioration of image quality.

- The maximum zoom factor depends on the image size setting and the digital zoom on/off settings.

1. Rotate the zoom controller to zoom.



 Wide Angle



 Telephoto

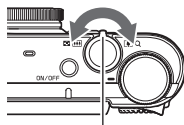

Zoom controller

 (Telephoto) : Enlarges the subject and narrows the range.

 (Wide Angle): Reduces the size of the subject and broadens the range.

2. Press the shutter button to shoot.

NOTE

- Use of a tripod is recommended to protect against image blur due to camera movement when shooting with telephoto.
- Performing a zoom operation changes the lens aperture.
- Zoom operations are supported during movie recording. Zoom operations are disabled during high speed movie recording. To use zoom, perform the zoom operation before you press  (Movie) to start recording.
- Zoom operations are not supported while shooting with the following BEST SHOT scenes. The zoom setting is fixed at full wide angle.
Slide Panorama, Wide Shot, All-In-Focus Macro

■ Zooming with the Function Ring (Step Zoom)

Assigning the Step Zoom function to the function ring lets you perform zoom operations (within the optical zoom range only) with the function ring (page 113). Step Zoom can be adjusted to the focal distances shown below.

19, 21, 24, 27, 34, 48, 75, 95

(Unit: mm; 35 mm film equivalents)

For finer zoom adjustment, use the zoom controller.

- The focal distance will be indicated on the monitor screen while Step Zoom is being adjusted with the function ring.



Current focal distance

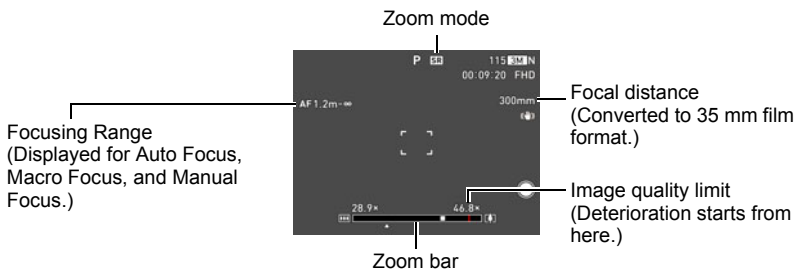

■ Monitor Screen Information when Zooming

A variety of information is shown on the monitor screen while a zoom operation is in progress.



■ Zoom Mode Icons

The table below shows what appears on the monitor screen based on the zoom mode.

Zoom mode	REC Screen Icon Display
Optical zoom, HD zoom	None
Single SR Zoom	 (White)
Multi SR Zoom	 (Black)
Digital zoom	

■ Interpreting the Zoom Bar

During a zoom operation, a zoom bar appears on the monitor screen to show the current zoom setting.

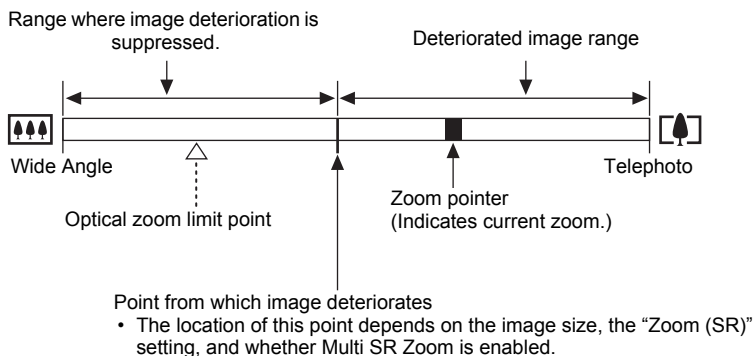

■ Zoom Factor

The digital zoom factor depends on the image size (page 121), the super resolution zoom setting, and on whether or not "Multi SR Zoom" is selected (page 60).

- Multi SR Zoom is enabled only when the "Multi SR Zoom" BEST SHOT scene is selected.

Image size	Optical zoom	Maximum zoom factor where image deterioration can be suppressed		Total maximum zoom factor (In combination with digital zoom)
		Zoom (SR): Off (HD Zoom)	Multi SR Zoom Zoom (SR): Single	
12M	5.0X	5.0X	10.0X	20.0X
3:2				
16:9		6.2X	12.3X	24.5X
8M				
3M				

Zooming with Super Resolution (Zoom (SR))

There are two types of Super Resolution Zoom: Single SR Zoom and Multi SR Zoom. Single SR Zoom uses super resolution to expand the zoom range in which image quality deterioration is minimized.

This section explains how to configure Single SR Zoom settings. For information about Multi SR Zoom, see page 60.

- For information about the zoom factor ranges in which SR Zoom is effective, see page 58.

1. Press [MENU].

2. Press [◀], use [▲] and [▼] to select the “ REC MENU” tab, and then press [▶].

3. Use [▲] and [▼] to select “Zoom (SR)” and then press [▶].

4. Use [▲] and [▼] to select “Single” and then press [SET].

NOTE

- Single SR Zoom is effective when you want to capture delicate textures.
- Single SR Zoom does not work during movie recording.
- Single SR Zoom is disabled when shooting with the following functions.
Triple Self-timer, Art Shot, Make-up Art, Time Lapse, Triple Shot, some BEST SHOT scenes

Expanding the Zoom Range to Shoot Clearer Snapshots (Multi SR Zoom)

This feature uses super resolution technology and multiple Continuous Shutter (CS) images to expand the zoom range for overall images of higher quality and clarity (page 59).

1. In the BEST SHOT Mode, select “Multi SR Zoom” (page 91).

2. Press the shutter button to shoot.

NOTE

- Multi SR Zoom is effective when you want to capture delicate textures.
- The following functions are disabled when shooting with Multi SR Zoom.
Single SR Zoom, Triple Self-time, Sharpness, Contrast
- With Multi SR Zoom, the flash setting automatically becomes  (Flash Off).
- Shooting with this function automatically sets Anti-shake Functions to “Standard” (page 119), but large movement of the camera or subject make it impossible to achieve the desired shot.
- Depending on shooting conditions and image composition, Multi SR Zoom may not be able to produce the desired result.

Shooting a Burst of Images (CS)

Shooting with High Speed CS



With High Speed CS, recording continues as long as you keep the shutter button depressed.

The table below shows the settings that can be specified for the CS speed and the number of images per High Speed CS operation.

CS Speed (High Speed CS fps)	3 fps, 5 fps, 10 fps, 15 fps, 30 fps fps = frames per second
Maximum CS Shots	5, 10, 20, 30

CS speed



Maximum CS shots

1. Align the mode dial with [P] (Program Auto).
2. Press [MENU].
3. Press [◀], use [▲] and [▼] to select the “📷 REC MENU” tab, and then press [▶].
4. Use [▲] and [▼] to select “CS”, and then press [▶].
5. Use [▲] and [▼] to select “High Speed CS” and then press [SET].
This will cause the recording mode icon on the screen to become 📷.
6. Press [SET].
7. Use [▲] and [▼] to select the 📷 (High Speed CS fps) Control Panel option and then press [SET].
8. Use [▲] and [▼] to select the continuous shutter (CS) speed you want and then press [◀].
 - Use a higher “High Speed CS fps” setting when shooting a fast-moving subject.

9. Use [▲] and [▼] to select the  (Maximum CS Shots) Control Panel option and then press [SET].

10. Use [▲] and [▼] to select the maximum number of shots and then press [SET].

11. Press the shutter button the rest of the way and hold it down.

Shooting of images will continue as long as you depress the shutter button or until the maximum number of images specified by “High Speed CS fps” is reached.

NOTE

- In addition to the **P** (Program Auto) mode, you can also use the following modes with High Speed CS: **A** (Aperture AE), **S** (Shutter Speed AE), and **M** (Manual Exposure).

Shooting with Prerecord CS

Half-pressing and holding the shutter button causes a pre-record buffer to be continually updated with images. When the shutter button is fully pressed, buffer contents are recorded along with a series of real-time images. Use Prerecord CS when you want to make sure you do not miss fast-moving action.

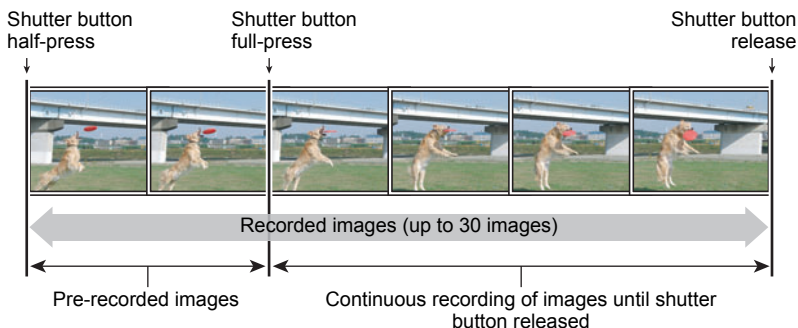

- 1. Perform steps 1 through 10 under “Shooting with High Speed CS” (page 61), and specify the CS speed and the maximum number of shots settings for each continuous shutter operation.**

- After you specify the maximum number of shots, press [◀] instead of [SET].

- 2. Use [▲] and [▼] to select the  (Pre-record CS Shots) Control Panel option and then press [SET].**

- 3. Use [▲] and [▼] to select the number of Pre-record (Still) images and then press [SET].**

- Settings: 0 shots, 3 shots, 5 shots, 10 shots, 15 shots, 20 shots, 25 shots
- If you select “0 shots”, no pre-record images will be stored when you half-press the shutter button.

- 4. Half-press and hold the shutter button to start pre-recording.**

A pre-record buffer is continually updated with images as long as the shutter button is pressed.

- The camera will not emit shutter sounds as it pre-records images.
- Releasing the half-pressed shutter button will cause the contents of the pre-record buffer to be deleted.

- 5. Full press and hold down the shutter button.**



This will record the images in the pre-record buffer followed by real-time recorded images. Shooting of images will continue as long as you depress the shutter or until the maximum number of images specified by “High Speed CS fps” is reached.

NOTE

- In addition to the **P** (Program Auto) mode, you can also use the following modes with Prerecord CS: **A** (Aperture AE), **S** (Shutter Speed AE), and **M** (Manual Exposure).
- The greater the number of shots, the longer it takes to save them after shooting is complete.
- When using a continuous shutter mode, keep the camera still until shooting is finished.
- Zoom is disabled during continuous shutter operations.
- The snapshot image quality automatically changes to “Normal”.
- Exposure and focus for the first image are applied for successive images as well.
- The flash setting automatically becomes  (Flash Off).
- The following image sizes cannot be selected: 3:2, 16:9. Entering the High Speed CS mode while any one of these image sizes is selected will cause the image size setting to change to “12M” automatically.
- The following functions cannot be used.
Motion Shutter, Triple Self-timer, Multi SR Zoom
- During CS recording some setting items are dimmed on the display and cannot be selected.
- The Self-timer cannot be used in the Prerecord CS mode.
- If you assign “CS” to the Key Customize (page 113) “L/R Key” setting, you can change the CS mode by pressing the [◀] or [▶] key.

Using Continuous Shutter with Auto Focus (AF CS)

AF CS shoots up to 30 CS images while keeping the subject in focus. This feature comes in handy when shooting children and other fast-moving subjects. A CS speed of up to maximum of six frames per second can be specified.

1. Align the mode dial with **[P]** (Program Auto).
2. Press **[MENU]**.
3. Press **[◀]**, use **[▲]** and **[▼]** to select the “ REC MENU” tab, and then press **[▶]**.
4. Use **[▲]** and **[▼]** to select “CS”, and then press **[▶]**.
5. Use **[▲]** and **[▼]** to select “AF CS” and then press **[SET]**.
This will cause the recording mode icon on the screen to become .
6. Press the shutter button the rest of the way down.
Hold down the shutter button to shoot up to 30 images at high speed.

NOTE

- In addition to the **P** (Program Auto) mode, you can also use the following modes with AF CS: **A** (Aperture AE), **S** (Shutter Speed AE), and **M** (Manual Exposure).
- Zoom is disabled during continuous shutter operations.
- The following image sizes cannot be selected while shooting with Auto Focus CS: 3:2, 16:9. If select AF CS while either of these image sizes is selected, the camera will automatically switch the images size setting to 12M.
- The following camera features cannot be used while shooting with Auto Focus CS: Motion Shutter, Triple Self-timer, Single SR Zoom.
- The settings below are fixed while shooting with AF CS.
 - Image Quality: Normal
 - Flash: Flash Off
 - Focus Mode: AF
 - AF Area: Spot

Triggering a Self-timer Operation with Motion (Motion Shutter)

With this feature, the camera automatically triggers a self-timer countdown whenever it detects movement in the vicinity of an icon on the monitor screen. This means you can control operation of the self-timer from a distance by waving your hand, so you can include yourself in the image being shot.



- 1. Select one of the following as the recording mode: Program Auto, Premium Auto Pro, or Make-up.**

- 2. Press [MENU].**

- 3. Press [◀], use [▲] and [▼] to select “📷 REC MENU” tab, and then press [▶].**

- 4. Use [▲] and [▼] to select “Motion Shutter”, and then press [▶].**

- 5. Use [▲] and [▼] to select “Motion Settings”, and then press [▶].**

- 6. Use [▲] and [▼] to select “Always” or “180°only”, and then press [SET].**
 - If you select “180°only”, go to step 7. Selecting “Always” activates Motion Shutter. Advance to step 8.

- 7. If you selected “180°only” in step 6 above, tilt the camera’s monitor screen 180 degrees (page 19).**

This activates Motion Shutter.





- 8. Press the shutter button (if you want to shoot a snapshot) or [●] (Movie) (if you want to shoot a movie).**
 - About three seconds after you press the shutter button or [●] (Movie) button, the camera will go into standby. This will cause the self-timer icon “👏” to change from flashing to blue.

- 9. Facing the camera, move your hand or perform some other movement in the vicinity of the 🙌 (start self-timer) icon on the monitor screen.**

When the camera detects movement near the icon, it will automatically shoot an image.

 - To stop movie recording, press [●] (Movie) again.



NOTE

- After shooting a snapshot, the camera will return to standby. Any one of the following will cancel a Motion Shutter operation.
 - Shooting 30 Motion Shutter snapshots
 - Pressing the shutter button during standby
 - Tilting the monitor screen
 - Rotating the camera
- The camera's Sleep function and Auto Power Off function are disabled during Motion Shutter standby.
- The Motion Shutter may not operate properly when there is little difference between the subject and the background of the icon, or when the subject is located far away from the camera.
-  (preview icon) will appear on the monitor screen when a snapshot is shot. When the camera detects movement in the vicinity of the preview icon, it will display the image that was shot for three seconds.
- " Tracking" cannot be selected for the AF area setting while shooting with the Motion Shutter. If " Tracking" is selected in another mode, selecting the Motion Shutter will cause the AF area setting to change to " Spot" (page 117).
- You cannot shoot a snapshot by pressing the shutter button while movie recording is in progress (Snapshot In Movie).

Configuring Motion Shutter Settings (Motion Shutter)

Use the procedure below to configure Motion Shutter settings.

1. In the REC mode, press [MENU].
2. Press [◀], use [▲] and [▼] to select the “ REC MENU” tab, and then press [▶].
3. Use [▲] and [▼] to select “Motion Shutter” and then press [▶].
4. Configure Motion Shutter settings.

Setting	Description
Motion Settings	Specifies the Motion Shutter activation operation. Always: Motion Shutter remains activated, regardless of whether or not the monitor screen is tilted. 180° only: Motion Shutter is activated when the monitor screen is tilted 180 degrees. Off: Motion Shutter disabled.
Timer	Specifies the amount of time that should elapse until shooting starts after the camera detects movement. Settings: 0.5 sec, 1 sec, 2 sec, 10 sec
Motion Position	Changes the positions of the self-timer icon “  ” and preview icon “  ”. [▲] [▼] [◀] [▶]: Moves the currently selected icon. [] (Wireless): Selects the icon to be moved.

Shooting a Wide View Photo (Wide View Photo)

This function shoots multiple images of different angles of view with a single shutter button operation. It comes in handy when you want to shoot both a foreground subject and a wide shot of the background with a single operation.

Shooting a Wide View Photo saves three images.

- Original image
- Part cut out of the original image
- Wide View Photo Movie
- A Wide View Photo Movie uses the original image and a cutout of the original image to create a movie that expands from a close up to a wider view. After sending wide view images to a smartphone, you can then upload them from the smartphone to a social networking site.

1. Align the mode dial with [WV] (Wide View Photo).

2. Rotate the function ring to select the size of the cutout image.

This displays a cutout image frame.

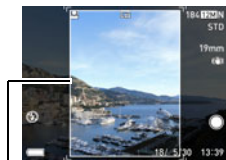

Cutout image frame

Frame Size	Aspect Ratio	Approximate Zoom Factor	Cutout Image Size*
Size 1	3:4	1.4X	6M (2112×2816)
Size 2	3:4	2.0X	3M (1536×2048)
Size 3	3:4	3.1X	1M (960×1280)
Size 4	3:4	6.3X	VGA (480×640)
Size 5	4:3	1.4X	6M (2816×2112)
Size 6	4:3	2.0X	3M (2048×1536)
Size 7	4:3	3.1X	1M (1280×960)
Size 8	4:3	6.3X	VGA (640×480)

* A portrait orientation image is fixed as portrait.

3. Half-press the shutter button.

If you move the camera while the shutter button is half-pressed, the cutout image frame will change position.

4. Press the shutter button all the way down to shoot.

- This will cause the message “Busy... Please wait...” to appear. The image processing operation takes some time to complete after the message appears. You will not be able to record another image while the message is displayed.

NOTE

- The original image size is fixed as 12M.
- The size of a wide view photo movie recorded with Wide View Photo is fixed as STD.
- When shooting with Wide View Photo, the AF area setting is fixed as “ Spot”.
- If the “Self-timer” setting is “x3” when Wide View Photo is selected, it will automatically change to “Off”.
- If the “Focus” setting is “MF” when Wide View Photo is selected, it will automatically change to “AF”.
- The functions below cannot be used together with Wide View Photo. Motion Shutter, Zoom (SR), Digital Zoom, CS
- You can change the zoom factor by rotating the zoom controller.
- The cutout frame may not operate properly when shooting the types of subjects described below.
 - Solid color wall or other very low contrast subject
 - Moving subject
- Performing an Auto Send operation of a cutout image recorded with Wide View Photo also sends its wide view photo movie.
- Deleting a cutout image also deletes its wide view photo movie. A wide view photo movie cannot be deleted independently.
- Protecting a cutout image also protects its wide view photo movie.
- The functions below cannot be used on a wide view photo movie created by Wide View Photo. Highlight Movie, Movie Editing, Movie Merge

Shooting with Artistic Effects (Art Shot)

A variety of artistic effects help to make even common, ordinary subjects become more novel and exciting.

Scene	Description
HDR Art	Uses HDR (High Dynamic Range, page 97) to turn normal images into works of art.
Toy Camera	Dark edges and altered hues make images look like they were shot by a toy camera.
Soft Focus	Overall blurring for a soft and romantic effect.
Light Tone	Weakened contrast for a feeling of airy refinement.
Pop	Enhanced saturation makes colors stand out in with rich clarity.
Sepia	Sepia tones create a decidedly retro look.
Monochrome	All of the strong contrast and graininess of a black and white print.
Miniature	Partial blurring makes scenes look like they are from of a miniature world.
Fisheye	A fisheye lens effect can be used to create a variety of humorous images.
Sparkling Shot	Softens the overall image and adds points of light for a sparkle effect.
Crystal Ball	Creates a mysterious effect by placing the image in a bubble floating in midair.
Art Shot Bracketing	Shoots a series of photos with HDR Art, Toy Camera, Monochrome, and Crystal Ball. A copy of the image (shot with Program Auto) without any effect applied is also saved at the beginning of the series of bracketed images.

1. Align the mode dial with **[ART]** (Art Shot).
2. Press **[SET]**.
3. Use **[▲]** and **[▼]** to select the **[ART]** Control Panel option, and then press **[SET]**.
This will display a menu of Art Shot scenes.
4. Select the Art Shot scene you want to use and then press **[SET]**.

5. Press [SET], use [▲] and [▼] to select the fifth Control Panel option from the top, and then press [SET].

The intensity of the selected effect can be adjusted as described below.

Scene	Adjustment
HDR Art	Effect level
Toy Camera	Hue
Soft Focus	Effect level
Light Tone	Hue
Pop	Effect level
Sepia	Effect level
Monochrome	Effect level
Miniature	Focus area
Fisheye	Effect level
Sparkling Shot	Effect type
Crystal Ball	Effect type

- When shooting with Art Shot Bracketing, effects are applied at the levels currently set for each applicable scene (HDR Art, Toy Camera, Monochrome, Crystal Ball). To change the level of one of these effects, select the applicable Art Shot scene and then perform step 5, above.

6. Use [▲] and [▼] to change the setting, and then press [SET].

7. Press the shutter button to shoot.

■ Using the Scene Information Screen

To find out more about a scene, select it with the boundary on the scene menu and then rotate the zoom controller in either direction.

- To return to the scene menu, rotate the zoom controller again.
- To scroll between scenes, use [◀] and [▶].
- To configure the camera with the settings for the currently selected scene, press [SET].

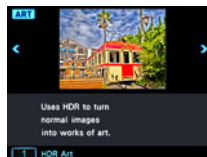

NOTE

- Depending on the “Art Shot” scenes, some of the items on the menu that appears may not be usable.
- The flash setting automatically becomes  (Flash Off).
- Movie recording is disabled while “Sparkling Shot” or “Art Shot Bracketing” is selected.
- After shooting an image with “Art Shot Bracketing”, you will not be able to shoot another image until save of the previous image is complete.
- With HDR Art Movie, the “Movie Quality” setting can be either “HD” or “STD” only (page 123). When any “Movie Quality” setting other than “STD” is selected in another mode, the “HD” setting is used when shooting with HDR Art Movie.
- When using “HDR Art” for movie recording, the intensity of the art effect is fixed in accordance with movie settings.
- An image shot with an Art Shot scene cannot be converted to a normal image without the Art Shot effect.

Saving a Second Normal Image When Shooting With HDR Art (Double (HDR Art))







You can configure the camera to save two images when shooting with HDR Art: one image with HDR Art effects applied in accordance with the scene you selected plus another normal (Program Auto) image without any effects applied.





1. Align the mode dial with **[ART]** and then press **[MENU]**.
2. Press **[◀]**, use **[▲]** and **[▼]** to select the “ REC MENU” tab, and then press **[▶]**.
3. Use **[▲]** and **[▼]** to select “Double (HDR Art)” and then press **[▶]**.
4. Use **[▲]** and **[▼]** to select “On” and then press **[SET]**.
While “Off” is selected for the above step, only a single HDR Art image is saved (normal image not saved).
5. Press the shutter button to shoot.

NOTE

- Except for HDR Art, shooting with an Art Shot scene saves only an Art Shot image. No companion normal (non Art Shot) image is saved.

Recording Beautiful Images of People and Scenery (Make-up Art)

This mode is suitable for use outdoors. It enhances the color saturation of scenery to create an artistic effect. A make-up effect is applied to the face of the human subject. The following image types are also available:  HDR,  Vivid,  Blurred Background,  Elegant,  Foggy,  Fairy,  Nostalgic

1. Align the mode dial with [+] (Make-up Art).
2. Press [SET], use [] and [] to select the  (Make-up Art) Control Panel option, and then press [SET].
This displays a menu of Make-up Art scenes.
3. Select the scene you want to use and then press [SET].
 - If you selected  Blurred Background, go to step 4. If you selected any other scene, go to step 5.
4. Select the blur effect level and then press [SET].
5. Press the shutter button to shoot.

NOTE

- When using Make-up Art, wait until the camera is able to detect a face before shooting.
- If the camera is unable to detect a face, a strong art effect may be applied to the face as well as to the background.
- Sample images shown on Make-up Art scene screens were not shot with this camera.
- An image shot with a Make-up Art scene cannot be converted to a normal (no Make-up Art effect) image.
- Shooting with  HDR can cause monitor screen response to slow down and may cause digital noise in the monitor screen image.



Using the Timer to Shoot a Selfie (Selfie Timer)

You can use the Selfie Timer to shoot self-portraits. You can set a Selfie Timer countdown duration within the range of two to five seconds.

- To use the Selfie Timer, you need to assign the Selfie Timer function to the front shutter button.

To assign the Selfie Timer to the front shutter button

1. In the REC mode, press [MENU].
2. Press [◀], use [▲] and [▼] to select the “📷 REC MENU” tab, and then press [▶].
3. Use [▲] and [▼] to select “Front Shutter” and then press [▶].
4. Use [▲] and [▼] to select the Selfie Timer setting you want and then press [SET].

Setting	REC Screen Icon Display	Pressing the front shutter button does this:
Selfie Timer		Shoots a single snapshot when the end of the countdown is reached.
×3 Selfie Timer		Shoots a total of three images at two-second intervals when the end of the countdown is reached.

To use the Selfie Timer to shoot a selfie

1. Tilt the camera's monitor screen 180 degrees (page 19).

2. Hold down the front shutter button to specify the Selfie Timer countdown duration.

- You can set a Selfie Timer countdown within the range of two to five seconds. The longer you hold down the front shutter button, the longer the Selfie Timer countdown duration indicated on the monitor screen.



3. Release the front shutter button.

The camera will shoot an image when the countdown reaches zero.

NOTE

- This function cannot be used in combination with some BEST SHOT scenes.
- Selfie Timer cannot be used for movie recording.
- Selfie-timer cannot be used while a Motion Shutter is activated. In this case, pressing the front shutter button records with Motion Shutter.

Recording Movies

To record a movie

The procedure below shows the steps for normal standard (STD or FHD) movie recording. For information about other types of movie recording (High Speed Movie), see page 81.

1. Align the mode dial with [P] (Program Auto) or [CoP] (Premium Auto Pro).

2. Press [MENU].

3. Press [◀], use [▲] and [▼] to select the "REC MENU" tab, and then press [▶].

4. Use [▲] and [▼] to select "Movie Quality" and then press [▶].

5. Use [▲] and [▼] to select the movie quality you want to use, and then press [SET].

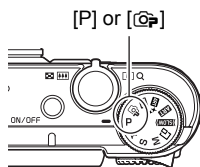

Movie Quality	REC Screen Icon Display	Frame Rate	Image Size (Pixels)
STD	STD	30fps	640×480
FHD	FHD	30fps	1920×1080

- fps (frames per second) is a unit of measurement for the number of images per second.
- Image size settings are fixed.
- When high-definition movie (FHD) is selected, the movie is shot with an aspect ratio of 16:9.
- The camera uses progressive scan for FHD movies.
- The shooting range for movies is smaller than that for snapshots. You can display the movie shooting range with "Shooting Info" (page 191).

6. Press [●] (Movie).

This will start recording and display  on the monitor screen.

Movie recording includes stereo audio.

- Pressing [SET] will re-start a Continuous AF operation (page 119).



Remaining recording time
(page 240)

7. Press [●] (Movie) again to stop recording.

- Each movie can be up to 29 minutes long. Movie recording stops automatically after 29 minutes of recording. Movie recording also will stop automatically if memory becomes full before you stop movie recording by pressing [●] (Movie) again.
- The movie is recorded in MOV format (page 191). The camera does not support conversion to a different movie format.

Recording Movies with Premium Auto Pro

When Premium Auto Pro is enabled (page 34), the camera automatically make judgments about the subject, shooting conditions, and other parameters. The result is higher quality images than those produced by Program Auto recording. The shooting environment detected by the camera is displayed at the bottom of the REC mode screen.



- Premium Auto Pro is enabled for FHD movies and STD movies only.
- Using Premium Auto Pro uses up the battery charge more quickly than using Program Auto recording.

Shooting with BEST SHOT

With BEST SHOT (page 89), you can select the sample scene that matches the type of movie you are trying to shoot and the camera will change its setup accordingly, for beautiful movies every time.

Minimizing the Effects of Camera Movement during Movie Recording

You can use Anti Shake (page 119) to configure the camera to minimize the effects of camera movement during FHD and STD movie recording. Note that Anti Shake cannot be used with HDR Art Movie and that Anti Shake does not prevent image blur due to subject movement.

Audio

Your camera has built-in microphones that can be used to record audio (stereo) during movie recording.

- Your camera has a function to reduce wind noise (Wind Noise Cut) when recording movies (page 126).

Recording Precautions

- The camera also records audio. Note the following points when shooting a movie.
 - Take care that the microphones are not blocked by your fingers, etc.
 - Good audio recording results are not possible when the camera is too far away from what you are trying to record.
 - Performing a zoom operation while shooting can cause zoom and/or auto focus noise to be in the audio recording.
 - Operating camera buttons while shooting can cause button noise to be picked up in the audio.
- When shooting with the “HS” movie quality at a frame rate setting of “30-120 fps” or “30-240 fps”, audio is recorded only while the camera is shooting at 30 fps. Audio is not recorded at any other frame rates (page 123).

Microphones

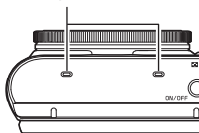

IMPORTANT!

- Spending a long time using movie recording will cause the camera to become slightly warm to the touch. This is normal and does not indicate malfunction.
- Shooting movies for long periods in areas where temperature is relatively high can cause digital noise (dots of light) to appear in the movie image. A rise in the camera's internal temperature also may force movie recording to stop automatically. If this happens, stop recording and allow the camera to cool down, which should cause normal operation to resume.
- Since the exposure follow up ranges are different for snapshots and movies, snapshot and movie shot in the same location may show different brightness levels.
- Use of the camera's built-in memory or certain types of memory cards can slow down processing speeds. In particular, high-quality movies may not be able to be stored correctly. A slow memory card can take too much time to record data and result in breaks in the image and/or audio during playback. When this happens a yellow “REC” indicator will appear on the monitor screen.

NOTE

- Zoom operations are supported during movie recording (page 56). Zoom is disabled during high speed movie recording. To use zoom for high speed movie recording, perform the zoom operation before you press [●] (Movie) to start recording.
- Single SR Zoom (page 59) is disabled during movie recording.
- The effects of camera movement in an image become more pronounced when you shoot close up or with a large zoom factor. Because of this, use of a tripod is recommended under these conditions.
- Except for High Speed Movie, Continuous AF (page 119) is performed during movie recording while "AF" (Auto Focus) or "Macro" is selected for the "Focus" setting.
- Face Detection is disabled during High Speed Movie recording.
- The following functions do not support movie recording.
Wide View Photo, Make-up Art, some BEST SHOT scenes
- The A, S, and M recording modes are not supported when shooting a movie, or when using the "Prerecord (Movie)" BEST SHOT scene. In these cases, the recording mode is always **P** (Program Auto).

Recording a High Speed Movie

This camera supports recording of high speed movies at a maximum speed of 1000 fps. The aspect ratio of movies recorded with this mode depends on the frame rate (recording speed).

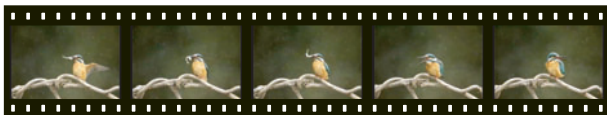

- When recording with the frame rate setting of “30-120 fps” or “30-240 fps” frame rate setting, audio recording is supported during 30 fps recording only. Audio is not recorded at any other frame rates.

1. Align the mode dial with [P] (Program Auto).

- High Speed Movie recording is not supported when shooting with Premium Auto Pro.

2. Press [MENU].

3. Press [◀], use [▲] and [▼] to select the “📷 REC MENU” tab, and then press [▶].

4. Use [▲] and [▼] to select “Movie Quality” and then press [▶].

5. Use [▲] and [▼] to select the frame rate (recording speed) you want and then press [SET].

A fast frame rate (such as 1000 fps) will result in a smaller image size.

Movie Quality	REC Screen Icon Display	Frame Rate	Image Size (Pixels)
HS1000	HS 1000	1000 fps	224×64
HS480	HS 480	480 fps	224×160
HS240	HS 240	240 fps	512×384
HS120	HS 120	120 fps	640×480
HS30-240	HS30 : 240	30-240 fps	512×384
HS30-120	HS30 : 120	30-120 fps	640×480

• fps (frames per second) is a unit of measurement indicating the number of images recorded or played back per second.

6. Record the movie the same way as you would a normal movie (page 77).

Press [●] (Movie) to start and stop recording.

- During High Speed Movie recording (HS120, HS240, HS480, HS1000), focus is fixed at the position where it was when recording started. To focus an image, half-press the shutter button for Auto Focus or focus manually before you press [●] (Movie) to start recording.
- Continuous AF is operational when recording at 30 fps with “HS30-120” or “HS30-240”. However, focus becomes fixed whenever you switch to 120 fps or 240 fps.
- When “HS30-120” or “HS30-240” is selected as the frame rate, recording always starts with a frame rate of 30 fps. You can switch the frame rate between 30 fps and 120 fps or between 30 fps and 240 fps only while recording is in progress. Press [◀], [▶], or [SET] to switch speeds. Audio is recorded only while shooting at a 30 fps.

NOTE

- The higher the frame rate (speed), the more lighting is required when shooting. When shooting a high speed movie, shoot in a well-lit environment.
- When recording certain types of movies, the image that appears on the monitor screen may be smaller than normal. When recording a high speed movie, there are black bands along the top, bottom, left, and right of the screen.
- When recording a high speed movie, light source flicker can cause horizontal bands to appear in the image. This does not indicate malfunction of the camera.
- Monitor screen content switching is disabled during high speed movie recording.

Using Prerecord Movie (Prerecord (Movie))

Prerecord (Movie) maintains a pre-recording of approximately five seconds of action (approximately two seconds for High Speed Movie). When you start real-time recording, the pre-recorded content is stored followed by the real-time recording, to help make sure you do not miss anything by being late pressing the record button.

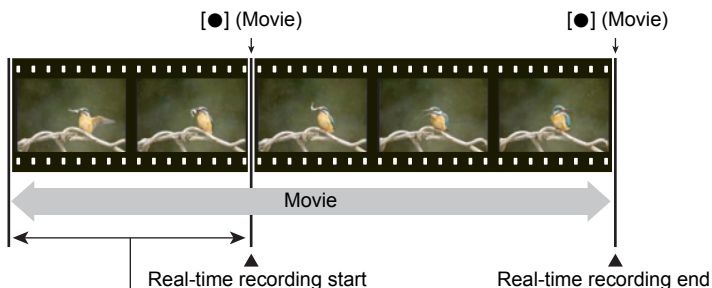

Approximately 5-second prerecorded part (from the buffer)

- Approximately two seconds for high speed movie

■ To set up the camera to shoot with Prerecord Movie

1. Align the mode dial with **[ES]** (BEST SHOT).

2. Press **[MENU]**.

3. Press **[◀]**, use **[▲]** and **[▼]** to select the “**REC MENU**” tab, and then press **[▶]**.

4. Use **[▲]** and **[▼]** to select “**Movie Quality**” and then press **[▶]**.

5. Use **[▲]** and **[▼]** to select the movie quality you want to use for shooting and then press **[SET]**.

6. Press **[SET]**.

7. Use **[▲]** and **[▼]** to select the **ES** Control Panel option, and then press **[SET]**.

8. Use **[▲]**, **[▼]**, **[◀]**, and **[▶]** to select the “**Prerecord (Movie)**” scene and then press **[SET]**.

This causes **[ES]** (Prerecord (Movie)) to appear on the monitor screen, indicating that the camera is prerecording to its buffer.

■ To shoot a Prerecord Movie

1. After using the above procedure to set up the camera for Prerecord Movie, point the camera at the subject.

2. When you are ready to record, press [●] (Movie).

This will save the approximately five seconds of action that was prerecorded in the buffer before you pressed [●] (Movie) (two seconds if you are using high speed movie) and start real-time recording.

3. Press [●] (Movie) again to stop recording.

- To turn off Prerecord Movie recording, align the mode dial with [P] (Program Auto) or [P⁺] (Premium Auto Pro).
- When shooting with the high speed movie “HS30-120” and “HS30-240” setting, you cannot change the speed (fps) setting while the camera is pre-recording to the buffer in step 1 of the above procedure. You can change the speed (fps) setting after you press [●] (Movie) to start real-time recording.

NOTE

- While the camera is set up for shooting with Prerecord Movie, pressing the shutter button will not shoot a snapshot unless movie recording is in progress. With high-definition (FHD) and standard (STD) movie, you can shoot still images while realtime movie recording is in progress.
- When shooting with Prerecord Movie in combination with high speed movie, rotating the control dial will not change the Exposure or white balance setting, even if “Exposure” or “White Balance” is assigned for the “Control Dial” function. To change the Exposure Compensation or white balance setting in this case, use the Control Panel.

Shooting a Snapshot while Shooting a Movie (Snapshot In Movie)

You can shoot snapshots while movie recording is in progress by pressing the shutter button. When the camera is in the Single Shot mode, you can shoot snapshots one-by-one. In the CS mode, holding down the shutter button will record up to seven consecutive images at a speed of approximately 10 images per second (fps). You can shoot a maximum total of 28 images during a single movie recording operation.

1. While a movie is being recorded, press the shutter button.

- Select FHD movie or STD movie as the movie quality setting (page 123).
- In the CS mode, images continue to be shot as long as you keep the shutter button depressed.
- While movie recording is in progress, you can toggle between the Single Shot Mode and the CS mode by pressing [CS] (Continuous Shutter), [\blacktriangleleft] or [\blacktriangleright]. Note that this method for mode switching is possible only during movie recording. The CS mode is indicated when CS is white (on the monitor screen), and the Single Shot mode is selected when SS is white.

Snapshot recording mode



Number of recordable snapshots

NOTE

- Note that the flash cannot be used.
- Note that shooting a snapshot while shooting a movie is supported during FHD movie and STD movie recording only. It is not supported during other types of movie recording.
- Auto-focus is not performed if you half press the shutter button to shoot a snapshot during movie recording. You can restart Continuous AF by pressing [SET].
- The field of view of a snapshot shot while FHD movie recording is in progress will be wider than the field of view of the FHD movie.
- The image quality automatically changes to "Normal".
- The P (Program Auto) recording mode is used when you shoot a snapshot during movie recording.
- Snapshot In Movie cannot be used to shoot snapshots while recording with any one of the movie recording modes below.
Motion Shutter, Time Lapse movie, Art Shot

Recording a Movie with a Slow Motion Section (Dramatic Slow Motion)

Use this feature to record a movie with a dramatic slow motion section. You can configure settings to control the length and timing of the slow motion section.

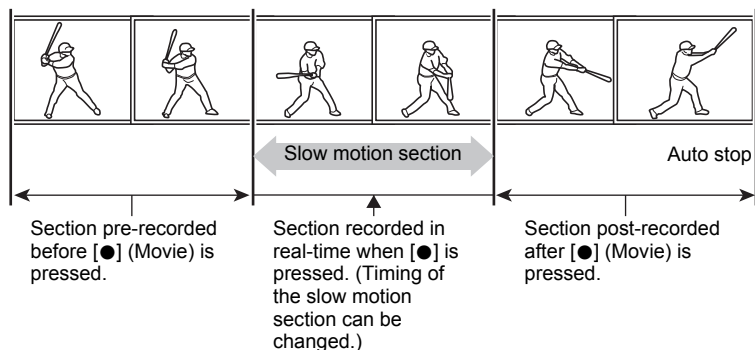

1. Align the mode dial with [] (SLOW) (Dramatic Slow Motion).

2. With the camera pointed at the subject, press [●] (Movie).

- This will save the action that was pre-recorded before you pressed [●] (Movie) and start real-time movie recording.
- Recording will stop automatically a preset amount of time after [●] (Movie) is pressed.

NOTE

- The slow motion section of the movie can be recorded with a "Movie Quality" setting of "HS120" or "HS240" only (page 123). Shooting a Dramatic Slow Motion movie while a movie quality setting other than "HS120" or "HS240" is selected, will cause the slow motion section to be recorded with the "HS120" movie quality setting.
- Audio is recorded only for the normal sections of the movie, not for the slow motion section.
- The functions below cannot be used in combination with Dramatic Slow Motion recording.
Self-timer, ISO, Make-up
- Perform a camera operation (displaying the menu, zoom or focus operation, etc.) while a Dramatic Slow Motion pre-recording operation is in progress will delete the current pre-recorded movie data. After that, you should wait a few seconds to allow accumulation for more pre-recording data before pressing the [●] (Movie) button to start recording. Otherwise, the pre-recorded section may be shorter than normal.

Configuring Dramatic Slow Motion Settings

You can configure settings to control the length and timing of the slow motion section.

1. Align the mode dial with [SLOW] (Dramatic Slow Motion).

2. Press [SET].

3. Use [▲] and [▼] to select  (Dramatic Slow Motion settings) on the control panel, and then press [SET].

This will display the Dramatic Slow Motion settings screen.

- You can also display the settings screen by rotating the function ring.

4. Use [▲] and [▼] to select the setting you want to configure, press [▶], and then use [▲] and [▼] to change the setting.

Configure the Dramatic Slow Motion settings described below.

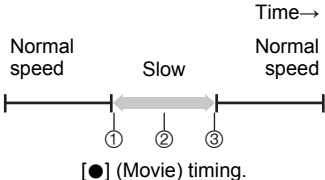
Slow Motion Time	Specifies the length of slow motion section before and after [●] (Movie) is pressed. Short, Normal, Long • The length of the slow motion sections of the three settings depends on the movie quality setting.
Timing	<p>Specifies the timing of slow motion recording. You can select a setting that suits the type of subject action (movement).</p>  <p>① Pre-Action: Use this setting when you know beforehand when the action will take place. Pressing [●] (Movie) when the subject starts moving will record subsequent movement in slow motion.</p> <p>② Action: Use this setting to record a specific action as it occurs. Pressing [●] (Movie) while the subject is moving will record past movement and subsequent movement in slow motion.</p> <p>③ Post-Action: Use this setting to record a goal scene or other action right after it happened. Pressing [●] (Movie) at the point you want to capture will record movement up to that point in slow motion.</p>

5. Press [SET].

Using BEST SHOT

BEST SHOT provides you with a collection of sample “scenes” that show a variety of different types of shooting conditions. When you need to change the setup of the camera, simply find the scene that matches what you are trying to achieve, and the camera sets up for it automatically. This helps to minimize the chance of ruined images due to poor exposure and shutter speed settings.

No.	Scene	Description
1	Make-up	Adjusts skin tone. Setting zoom to telephoto blurs the background. → page 94
2	Make-up BKT	Shoots 3 images with different skin tone settings. → page 95
3	Triple Shot	Shoots a series of three images from before and after the shutter button press. → page 96
4	Magnifying Glass	SR Zoom magnification from closest macro zoom position.
5	HS Night Scene	Auto detection of handheld or tripod shooting for beautiful, blur-free night scenes.
6	HS Night Scene and Portrait	Auto detection of handheld or tripod shooting for beautiful night scenes and portraits.
7	HS Night Shot	Enables recording of an image without flash, even when lighting is dim.
8	HDR	Combines multiple images for best exposure, even for complex brightness conditions. → page 97
9	HS Anti Shake	Records multiple images and combines them into a single image to correct image blur.
10	All-In-Focus Macro	In-focus macro shooting up to distant scenery.
11	Multi SR Zoom	Enhanced resolution and expanded zoom range.
12	Slide Panorama	Sweep the camera in the direction you want to shoot a wide panorama. → page 98
13	Wide Shot	Sweep the camera to shoot a wide image. → page 100
14	INT Interval Shot	You can specify the shooting interval and the number of shots. → page 103
15	4K Standard	Lets you view long movies more quickly. You can specify the shooting interval and time.
16	4K Clouds	For images that capture the feel of clouds floating across the sky.
17	4K Sundown	Reproduces all the beauty and drama of the setting sun.

No.	Scene	Description
18	Scenery	Hard sharpness High saturation
19	Portrait With Scenery	Adjustable skin tone. Wide angle zoom simplifies focusing of people and scenery.
20	Children	Fast shutter speed
21	Sports	Fast shutter speed
22	Candlelight Portrait	Soft sharpness and tungsten white balance. Keep the camera still!
23	Party	Fast shutter speed
24	Pet	Fast shutter speed Shoot from the eye level of your pet.
25	Flower	Macro Mode High saturation
26	Natural Green	Hard sharpness and high saturation enhance green hues.
27	Autumn Leaves	Hard sharpness and high saturation enhance red hues.
28	Soft Flowing Water	Slow shutter speed
29	Splashing Water	Fast shutter speed
30	Sunset	Red filter Daylight white balance
31	Fireworks	Slow shutter speed Keep the camera still!
32	Food	Macro Mode High saturation
33	Text	Macro Mode Hard sharpness High contrast
34	RAW Image	RAW image file recording. JPEG data version is also saved. → page 107
35	Prerecord (Movie)	Continually pre-records movie images, which are saved when [MOVIE] is pressed. → page 83
36	HDMI TV Output	Displays camera screen contents on a TV over an HDMI cable connection. → page 108
100	Register User Scene (Custom Shot)	Registers a new user scene. Press the [SET] button to start image selection. → page 93

To shoot with BEST SHOT

1. Align the mode dial with **[BS]** (BEST SHOT).
2. Press **[SET]**.
3. Use **[▲]** and **[▼]** to select the **[BS]** Control Panel option, and then press **[SET]**.
This will display a menu of BEST SHOT scenes.
4. Use **[▲]**, **[▼]**, **[◀]**, and **[▶]** to move the boundary to the scene you want to select.
 - You can scroll to another page of scenes by pressing **[▲]** or **[▼]**, or rotating the function ring.
5. Press **[SET]** to configure the camera with the settings for the currently selected scene.
This returns to the REC mode.
 - To select a different BEST SHOT scene, repeat the above procedure from step 2.
6. Press the shutter button (if you are shooting a snapshot) or **[●]** (Movie) (if you are shooting a movie).

- With some BEST SHOT scenes, the message “Busy... Please wait...” will appear on the monitor screen after you press the shutter button. The camera is in the process of recording an image until the message appears. Keep the camera still. The image processing operation takes some time to complete after the message appears. You will not be able to record another image while the message is displayed.

■ Using the Scene Information Screen

To find out more about a scene, select it with the boundary on the scene menu and then rotate the zoom controller in either direction.

- To return to the scene menu, rotate the zoom controller again.
- To scroll between scenes, use **[◀]** and **[▶]**.
- To configure the camera with the settings for the currently selected scene, press **[SET]**.

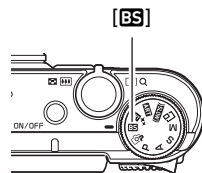

Currently selected scene (with boundary)





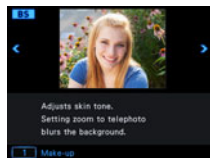

Scene name

Scene number



■ BEST SHOT Precautions

- Sample images shown on BEST SHOT scene screens were not shot with this camera. There are provided to illustrate the effects and merits of each scene.
- Images shot using a BEST SHOT scene may not produce the results you expected due to shooting conditions and other factors.
- You can modify the camera settings that are configured after you select a BEST SHOT scene. Note, however, that the BEST SHOT settings revert to their defaults when you select another BEST SHOT scene or turn off the camera.
- Snapshot shooting is disabled while the following BEST SHOT scenes are being used.
Prerecord (Movie),  Standard,  Clouds,  Sundown
- Movie recording is disabled while the following BEST SHOT scenes are being used.
Make-up BKT, Magnifying Glass, All-In-Focus Macro, HS Anti Shake, Wide Shot, HS Night Shot, Slide Panorama, HDMI TV Output, Triple Shot, HDR, Multi SR Zoom,  Interval Shot
- When the movie recording mode is **FHD/STD**, movies are recorded using the settings of the selected BEST SHOT scene. For high speed movie recording, BEST SHOT scene settings are ignored and movie recording is performed as it normally is.
- BEST SHOT scenes that use High Speed CS ignore the “Zoom (SR)” setting.
- With the BEST SHOT scenes below, certain shooting conditions can cause the image area to become narrower than normal.
HS Night Scene and Portrait, HS Night Shot
- When shooting with All-In-Focus Macro, the focus range (page 48) is approximately 10 cm.
- When shooting with All-In-Focus Macro, the camera will display the message “Could not merge. Will record as normal images.” if it judges that it cannot perform an operation. The images shot by the camera will be saved even if they cannot be merged.

Creating and Using Your Own Setups (Custom Shot)

You can register up to 999 setups, based on snapshots shot with the camera, as “Custom Shot” scenes. Selecting a registered “Custom Shot” scene configures the camera with its settings. The setups of snapshots recorded with the following modes and features can be registered as “Custom Shot” scenes.

- Program Auto
- A Mode
- S Mode
- M Mode
- BEST SHOT (Excluding “Prerecord (Movie)”, and “HDMI TV Output”)

■ To register a “Custom Shot” scene

1. In the BEST SHOT Mode, select “Custom Shot (Register User Scene)” (page 89).

2. Use [◀] and [▶] to select the snapshot whose setup you want to save.

3. Select “Save”, and then press [SET].

Your scene will be assigned the name “Custom Scene”, along with a scene number.

NOTE

- A movie setup cannot be registered as a “Custom Shot” scene.
- You can check the settings of the currently selected “Custom Shot” scene by displaying the camera’s setting menus and looking at its settings.
- “Custom Shot” scenes are assigned numbers in the sequence: U1, U2, and so on.
- The following are the settings that are saved for each “Custom Shot” scene. Face Detection, Focus, Exposure, White Balance, Flash, ISO, Metering, Lighting, Flash Intensity, Sharpness, Saturation, Contrast
- “Custom Shot” scenes are stored in built-in memory (page 191) in the SCENE folder (snapshots).
- Formatting the camera’s built-in memory (page 201) deletes all user “Custom Shot” scenes.
- Use the following procedure when you want to delete a “Custom Shot” scene.
 - ① Display the information screen (page 91) of the user BEST SHOT scene you want to delete.
 - ② Press [▼] (), select “Clear”, and then press [SET].

■ To record with a registered Custom Shot scene

1. In the BEST SHOT Mode, select the registered “Custom Scene” (page 91).
2. Press the shutter button to shoot.

Recording Beautiful Portraits (Make-up)

Make-up enables adjustment of human skin tone hues and texture, and softening of facial shadows caused by harsh sunlight for better looking portraits.

1. In the BEST SHOT Mode, select “Make-up” (page 89).
2. Press [SET], and then select the “” (Make-up Settings) Control Panel option (page 44).
3. Select the setting you want, and change the setting value.

① Smooth Skin	Adjusts skin smoothness.
② Skin Tone	Adjusts the complexion setting.
③ Face Brightness	Adjusts face brightness.
④ Sculpt	Adjusts detail enhancement.



4. Press [SET].

Shooting Three Versions of an Image with Different Skin Tone Settings (Make-up BKT)

Make-up Bracketing (Make-up BKT) lets you shoot four versions of the same image with the press of the shutter button, each with a different Skin Tone setting (Natural, Natural Brightening, Brightening, Pink).

1. In the **BEST SHOT Mode**, select **“Make-up BKT”** (page 89).
2. Press **[SET]**, and then select the **“”** (Make-up Settings) Control Panel item (page 44).
3. Select the setting you want, and change the setting value.

Smooth Skin	“0” to “+6”
Face Brightness	“-3” to “+3”
Sculpt	“-3” to “+3”

4. Press **[SET]**.
5. Press the shutter button to shoot.

This will shoot and store four versions of the same image with various “Skin Tone” settings, based on the setting you selected in step 3, above.

NOTE

- After shooting an image with Make-up BKT, you will not be able to shoot another image until save of the previous image is complete.
- Movie recording is disabled while Make-up BKT is selected.

Shooting with Triple Shot

Triple Shot shoots a burst of three images and stores them in memory. This feature is great for making sure you don't miss those special moments when kids are around.

1. In the BEST SHOT Mode, select "Triple Shot" (page 89).

2. Point the camera at the subject and then half-press the shutter button.

The camera will start pre-recording images at this time.

- If you release the half-pressed shutter button before pressing it the rest of the way down, all of the images currently in the pre-record buffer will be deleted.

3. Press the shutter button all the way down to record.

This will record three images: one of the action before the shutter button is fully pressed plus two real-time images.

- Pressing the shutter button all the way without first half-pressing it will result in only two images being recorded.

NOTE

- The settings below are fixed while shooting with this function.
 - Self-timer: Off
 - Flash: Flash Off
 - Image Quality: Normal
 - Single SR Zoom: Off
 - Face Detection: On
 - Focus Mode: AF
 - AF Area: "Intelligent" or "Spot"*
- * If you select "Multi" or "Tracking" for this setting in another mode and then shoot with Triple Shot, shooting is performed using the "Spot" setting.

Digitally Correcting for Overexposure and Underexposure (HDR)

With HDR (High Dynamic Range), the camera shoots a series of CS images using different exposure settings and combines them into a final image to correct for overexposure or underexposure of subjects of different brightness levels.

1. In the **BEST SHOT Mode**, select “HDR” (page 89).
2. Press [SET], and then select the  (HDR Level) Control Panel option (page 44).
3. Select the HDR Level setting you want, and then press [SET].
 - You can select one of three HDR levels.

NOTE

- HDR works best when shooting with the camera mounted on a tripod.
- Shooting with this function causes the flash setting to change automatically to  (Flash Off).
- Anti Shake correction performed to compensate for camera movement while shooting with this function results in an image area that is narrower than normal.
- The desired HDR effect may not be attained if the camera or subject moves during shooting.

Shooting a Panorama Image (Slide Panorama)

With Slide Panorama, you move the camera to compose and record multiple images, which are then combined to a panorama. This feature lets you shoot a panorama of up to 360 degrees, which is dramatically greater than the physical capabilities of the lens.



- Zoom operations are not supporting during Slide Panorama shooting. The zoom setting is fixed at full wide angle.
- You can use Slide Panorama to shoot a horizontal image up to approximately 360 degrees and a vertical image up to approximately 180 degrees.

1. In the **BEST SHOT Mode**, select “Slide Panorama” (page 89).
2. Press **[SET]**, and then select the  (Slide Direction) Control Panel option (page 44).

- You can also select the Slide Direction by rotating the function ring.

3. Select the direction you are planning to move the camera while shooting, and then press **[SET]**.

You can select one of four directions: Right, Left, Up, or Down.

4. Point the camera at the start of the panorama and half-press the shutter button to allow the camera to focus automatically.

5. Press the shutter button the rest of the way down and a slide cursor will appear on the monitor screen. Slowly move the camera in the direction indicated by the arrow on the screen until the slide cursor reaches the other end of its movement range (i.e. all the way to the right) when moving the camera to the right).

- The camera will start composing the panorama image internally when the slide cursor reached the other end of the movement range.
- Image composing also will start automatically if you stop moving the camera during panorama shooting.

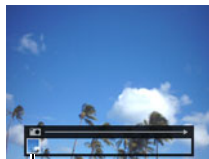

Slide cursor

NOTE

- The following conditions are not compatible with Slide Panorama shooting.
 - Subject whose brightness is very different from that of its surroundings due to artificial light, sunlight, etc.
 - Rivers, waves, waterfalls, or other subject with constantly changing patterns
 - Sky, beach, or other subject with continuous patterns
 - Camera too close to the main subject
 - Moving subject
 - Dark surroundings
- Slide Panorama may stop part way through in the following cases.
 - Subject or camera movement
 - Camera movement that is too fast or too slow
- Shooting a Slide Panorama image after half-pressing the shutter button to perform Auto Focus may not produce the desired results if there are considerable differences in the brightness, color, and/or focus of the individual images. If this happens, try changing the focus position by focusing on a different subject, etc.
- Since a Slide Panorama image is created by joining multiple images together, there may be some roughness at the point where two images are joined.
- Shooting under a flickering light source (such as fluorescent lighting) may result in uneven brightness and/or coloring in the final Slide Panorama image.
- The exposure and white balance when shooting Slide Panorama images are fixed at the levels measured when you half-press the shutter button at the beginning of the operation.
- Shooting with this function causes the flash setting to change automatically to  (Flash Off).

Shooting with a Super Wide Angle of View (Wide Shot)

With this feature, a number of images are shot and then combined to produce an image with a super-wide angle of view that exceeds the widest angle of view possible with the lens. Converted to 35 mm equivalents, the focal distances available with this feature enable shooting with approximate angles of view of 11 mm and 14 mm.

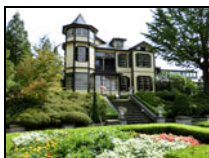

19 mm (lens widest angle)

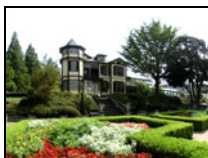

14 mm



11 mm

1. In the **BEST SHOT Mode**, select “Wide Shot” (page 89).
2. Press [SET], and then select the  (Wide Level) Control Panel option (page 44).
3. Select the width setting (angle of view) you want and then press [SET].
There are two settings available: “14 mm” and “11 mm”.
“11 mm” shoots a wider area than “14 mm”.
4. Hold the camera so it is upright, with the shutter button and other controls at the bottom.

- Do not point the camera straight down at the ground at this time. If you do, the camera’s built-in vertical/horizontal position sensor will not operate properly and may make it impossible to start shooting.

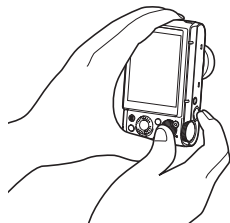

5. Point the camera at the subject you want in the center of the image and then half-press the shutter button to focus.

- The outer blue boundary on the screen indicates the recordable range of the image.

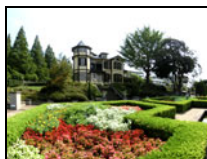

Desired image



Blue boundary

Center part at the start of the shooting operation

6. Press the shutter button the rest of the way down and slowly move the camera in accordance with the instructions and arrow that appear on the monitor screen.

- Holding the camera firmly with both hands, follow the instructions that appear on the monitor screen to slowly slide the camera horizontally or vertically at a constant speed in an arc centered on your body.
 - When sliding the camera horizontally, do not allow your body to move left or right. A vertical line running through your body should serve as the axis.
 - When sliding the camera vertically, do not allow your body to move upwards or downwards. A horizontal line between your shoulders should serve as the axis.
 - Take care not to slide the camera diagonally and be sure to maintain a firm grip on it.
- The camera will start composing the super-wide image internally when the slide cursor reached the other end of the movement range.
- Image composing also will start automatically if you stop moving the camera during super-wide shooting.

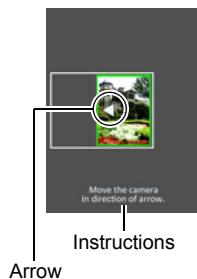

NOTE

- The “11 mm” and “14 mm” angle of view values are approximate and are provided for reference only. Actual angle of view values are not guaranteed.
- Zoom operations are not supported during Wide Shot shooting. The zoom setting is fixed at full wide angle.
- This function makes it possible to shoot images with a maximum angle of view of 11 mm or 14 mm. Note, however, that shooting conditions can result in a smaller angle of view.
- The following conditions are not compatible with Wide Shot shooting.
 - Subject whose brightness is very different from that of its surroundings due to artificial light, sunlight, etc.
 - Rivers, waves, waterfalls, or other subject with constantly changing patterns
 - Sky, beach, or other subject with continuous patterns
 - Camera too close to the main subject
 - Moving subject
 - Panning upwards on a skyscraper or some other very tall structure or object
 - Dark surroundings
- Any of the following can cause Wide Shot operation to stop part way through.
 - Subject or camera movement
 - Camera movement that is too fast or too slow
 - Camera movement outside of the required route
 - Camera movement in the wrong direction



- Shooting a Wide Shot image after half-pressing the shutter button to perform Auto Focus may not produce the desired results if there are considerable differences in the brightness, color, and/or focus of the individual images. If this happens, try changing the focus position by focusing on a different subject, etc.
- Since a Wide Shot image is created by joining multiple images together, there may be some roughness at the point where two images are joined.
- Shooting under a flickering light source (such as fluorescent lighting) may result in uneven brightness and/or coloring in the final Wide Shot image.
- The exposure and white balance when shooting Wide Shot images are fixed at the levels measured when you half-press the shutter button at the beginning of the operation.
- With this BEST SHOT scene, the flash setting automatically becomes  (Flash Off).

Shooting Multiple Images Over a Specified Period (Interval Shot)

You can use the procedure below to record a series of images over a specified period (Interval Shot). This function is useful when recording the movement of a blooming flower, etc.

- The maximum possible Interval Shot operation period is 20 days (60-minute interval, 500 images).
- When using this function, shooting with a tripod is recommended.
- To prevent loss of power while shooting, use a fully charged battery.
- Make sure the memory card you are using has sufficient unused space before using this function.
- Focus is fixed at what they are when shooting is started.

1. In the **BEST SHOT Mode**, select “**INT Interval Shot**”, and then press **[SET]**.
2. Press **[SET]**, use **[▲]** and **[▼]** to select the **⊕ (Interval Setting) Control Panel** option, and then press **[SET]**.
3. Use **[▲]** and **[▼]** to select “**Interval**” or “**Shots**”, press **[▶]**, and then use **[▲]** and **[▼]** to change the setting.

 Interval	Specifies the shooting interval.
 Shots	Specifies the number of shots.

4. Press **[SET]**.

- The current Interval Shot settings are shown at the bottom of the monitor screen.

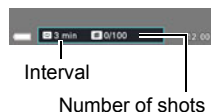

5. Press the shutter button to start recording.

- Shooting is repeated at the interval specified in step 3.
- Recording stops when the recording time specified in step 3 elapses or when the shutter button is pressed again.



NOTE



- The monitor screen is blank while a time lapse operation is in progress. The camera's back lamp will be lit to indicate that recording is in progress. Performing a camera operation while the monitor screen is blank will cause screen contents to appear. Note, however, that changing the mode dial setting will cause the Interval Shot operation to stop.
- If the "Interval" setting is one minute or greater, the camera's lens will retract and the back lamp will go out between shots. Pressing [ON/OFF] (Power) while an Interval Shot operation is in progress will cause a message to appear. The camera's battery can be charged over a USB connection while the lens is retracted during Interval Shot. If you want the battery to be charged during Interval Shot, set up the USB connection before starting the recording operation. Connecting the USB cable while the lens is extended will cause camera power to turn off.
- The "Auto Flash" and "Red Eye Reduction" flash settings are not supported while a setting other than "Auto" is selected for the "Aperture" or "Shutter Speed" setting while using Interval Shot. Selecting Interval Shot while an unsupported flash setting is in effect will cause the flash mode setting to change automatically to "Flash Off".
- The functions below cannot be used with this function.
Shoot with phone, High Speed CS, Motion Shutter, Anti-shake Functions, Zoom (SR), Continuous AF, Face Detection, MF (Manual Focus)
- Pressing the shutter button during standby between interval shots (while the monitor screen is on) will cause "Interval recording was canceled." to appear, and the interval operation will be canceled.
- The Auto Power Off is disabled while shooting with this function (page 197).



Recording a Time Lapse Movie (Time Lapse)



You can use this function to record movies of natural events that occur over time, to speed up the flow of traffic in a city scene, or to record other similar types of movies. Time Lapse provides a collection of sample scenes that show various types of images. Simply selecting a scene causes the camera to set up automatically with optimal settings for the subject type and conditions shown in the sample scene.

Scene	Description
Interval Shot	You can specify the shooting interval and the number of shots. → page 103
Standard	Lets you view long movies more quickly. You can specify the shooting interval and time.
Clouds	For images that capture the feel of clouds floating across the sky.
Sundown	Reproduces all the beauty and drama of the setting sun.

- Normally, you should use the “ Standard” scene.
- When using this function, shooting with a tripod is recommended.
- To prevent loss of power while shooting, use a fully charged battery.
- Make sure the memory card you are using has sufficient unused space before shooting with this function.
- Focus is fixed at what they are when shooting is started.
- For some scenes, brightness and white balance settings are fixed at what they are when shooting is started.

- 1. In the BEST SHOT Mode, select the Time Lapse scene you want to use (page 89).**
- 2. Press [SET], use [▲] and [▼] to select the  (Time Lapse Settings) Control Panel option, and then press [SET].**
- 3. Use [▲] and [▼] to select “ Interval” or “ Total Time”, press [▶], and then use [▲] and [▼] to change the setting.**

Each scene is initially configured with unique “ Interval” and “ Total Time” default settings. Change these settings, if you want.

 Interval	Specifies the number of seconds between shots.
 Total Time	Specifies the recording time. Selecting “Off” causes recording to continue until the shutter button is pressed again.

4. Press [SET].

- Time Lapse settings are shown at the bottom of the screen.

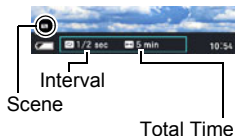

5. Press the shutter button to start recording.

- Shooting is repeated at the interval specified in step 3.
- Recording stops when the recording time specified in step 3 elapses or when the shutter button is pressed again.
- Remaining recording time is not displayed when the "[] Total Time" setting is "Off".



NOTE

- During Time Lapse recording, the monitor screen will turn off in accordance with the "Sleep" setting (page 197). Change the "Sleep" setting to "Off" if you want the monitor screen to stay on. Note, however, that this setting will use up battery power more quickly.
- If sleep is enabled (page 197), the monitor screen will turn off after the preset sleep period if no camera operation is performed, but the time lapse recording operation will continue. The camera's back lamp will flash at this time. Performing any operation while the monitor screen is blank will turn it back on. However, the following operations will not turn the monitor screen back on.
 - Pressing [ON/OFF] (Power)
 - Pressing the shutter button all the way
 - Rotating the mode dial
- The Auto Power Off is disabled while time lapse recording is in progress (page 197).
- The following functions cannot be used with this function. Single SR Zoom, Anti-shake Functions, Lighting, Continuous AF, Triple Self-timer, Motion Shutter, Face Detection, Metering, ISO, ISO High Limit, Make-up
- The frame rate of playback of movies shot with this function is 20 fps. Movie quality is always FHD.
- Note that audio is not recorded when recording with this function.
- The camera can be configured to play only Time Lapse movies during a slideshow (page 144).
- You cannot shoot a snapshot by pressing the shutter button while time lapse recording is in progress (Snapshot In Movie).

■ Using the Scene Information Screen

To find out more about a scene, select it with the boundary on the scene menu and then rotate the zoom controller in either direction.

- To return to the scene menu, rotate the zoom controller again.
- To scroll between scenes, use [◀] and [▶].
- To configure the camera with the settings for the currently selected scene, press [SET].

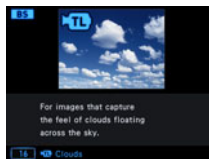

Shooting RAW Images (RAW Image)

You can configure the camera to save a RAW image* along with a standard JPEG image when shooting snapshots. RAW image data is stored in a camera folder named "RAW" (page 191).

* A RAW image is image data (file name extension .DNG) that is unprocessed internally by the camera. Since there is no image deterioration, RAW files provide more creative freedom when used with software that supports general-purpose DNG format files.

1. In the BEST SHOT Mode, select "RAW Image" (page 89).

NOTE

- The image size is fixed at 12M when shooting with this function.
- Single SR Zoom and Digital Zoom cannot be used with this function. Only optical zoom can be used, up to a maximum zoom factor of 1.3X (24mm when converted to 35mm film).
- Shooting of RAW image data is not supported for movie recording.

Using a TV Screen to Shoot Snapshots (HDMI TV Output)

Use the procedure below to configure the camera for shooting snapshots with an aspect ratio of 16:9, as you compose them on a TV screen.

1. Turn off the camera and use a commercially available HDMI cable to connect the camera to a TV.

- Use a commercially available HDMI cable that is marked with the logo shown to the right.
- Make sure that the camera is turned off before plugging in or unplugging the cable. Check the user documentation that comes with the TV for information about requirements before plugging into or unplugging from the TV.

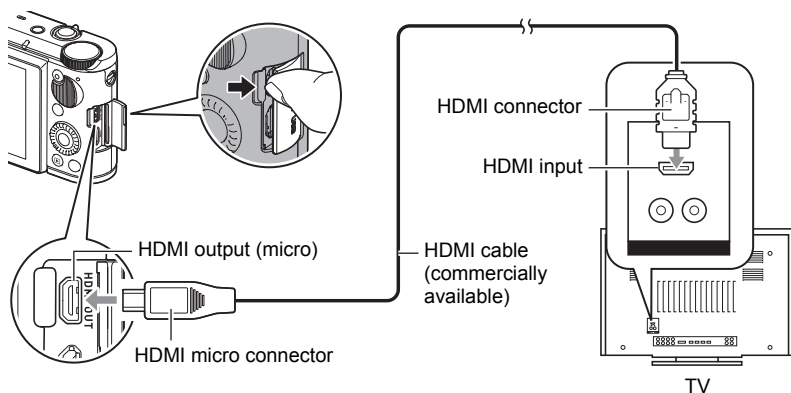

2. Turn on the camera.

3. In the BEST SHOT Mode, select “HDMI TV Output” (page 89).

This will turn off the camera’s monitor screen and display an image composition screen on the connected TV.

4. Compose the image on the TV screen and press the shutter button to shoot.

NOTE

- For details about connecting to the camera and precautions when connecting, see page 108.
- If you want to change the digital video signal format, first unplug the HDMI cable from the camera (page 138).
- Shooting with this function is not supported with Premium Auto Pro or other recording modes.
- The settings below are fixed. These settings cannot be changed when shooting with this function.
 - Image Size: 16:9
 - AF Area: Spot
 - Continuous AF: Off
 - Face Detection: Off
 - Make-up
 - Skin Tone: Natural
 - Other Items: 0
 - White Balance: Auto WB
 - Metering: Multi
- You will not be able to enter a wireless mode (page 160) by pressing [📶] (Wireless) during HDMI TV output. If you want to use a wireless mode, either select a scene other than “HDMI TV Output”, change to a different recording mode, or disconnect the HDMI cable from the camera.

Using the Menu Screen to Configure Recording Settings

This section explains menu items that you can use to configure recording mode settings.

1. In the REC mode, press [MENU].

This will display the menu screen (📷 REC MENU).

2. Press [◀], use [▲] and [▼] to select the “📷 REC MENU” tab, and then press [▶] or [SET].

3. Select the item you want and then change its setting.

- For information about menu operations, see page 32.

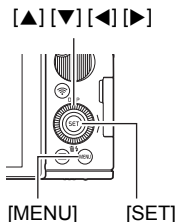

Example:
When “Self-timer” is selected on the “📷 REC MENU” tab

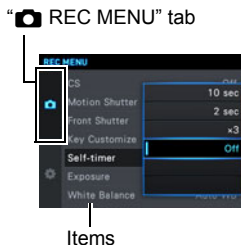

Shooting a Burst of Images (CS)

Menu item: CS

See page 61 for details.

Triggering a Self-timer Operation with Motion (Motion Shutter)







Menu item: Motion Shutter

See page 66 for details.

Assigning a Recording Function to the Front Shutter Button (Front Shutter)

Menu item: Front Shutter

This setting can be used to assign the recording function to be performed when the front shutter button is pressed while the camera is in the REC mode.

Setting	REC Screen Icon Display	Description (When front shutter button is pressed)
Standard		Normal recording using the current camera setup.
AF less		Half-pressing the front shutter button immediately shoots a snapshot without adjusting focus, so there is less time lag between shutter button operation and shooting than there is when using the top shutter button. If you want to focus (with AF) before shooting, half-press the top shutter button to focus. Next, press the front shutter button to shoot. This front shutter operation can be used for shooting single snapshots only.
Selfie Timer		Shoots one selfie (Selfie Timer) or a series of three (Selfie Timer × 3) selfies at the end of a countdown. Countdown length depends on how long the front shutter button is depressed (page 75).
×3 Selfie Timer		
CS		Recording of a series of up to 10 images at 10 fps. This function can be used only when the recording mode is Program Auto and the "CS" menu item setting (page 61) is "Off".
Off		No recording.

NOTE

- Front shutter button operation will become disabled while shooting with some BEST SHOT scenes.
- For front shutter button operations in the PLAY mode, see page 139.
- When the "Front Shutter" setting is something other than "Off", the front shutter button can be used to shoot a snapshot while movie recording is in progress (Snapshot In Movie). In this case, however, only a single snapshot can be recorded. You cannot shoot a Continuous Shutter (CS) image during movie recording.

Assigning Functions to the Function Ring and Control Dial (Key Customize)

Menu item: Key Customize

Key Customize lets you assign any one of the functions listed below to the function ring, [◀] and [▶], Control Dial keys.

Operation	Setting	Description	See page:
Function Ring*1	Step Zoom	Changes the zoom factor.	Page 57
	Exposure	Corrects brightness.	Page 52
	ISO	Changes the ISO sensitivity setting.	Page 50
	White Balance	Adjusts hue.	Page 46
	MF*2	Adjusts focus.	Page 48
	Smooth Skin	Adjusts skin smoothness.	Page 51
	Shutter Speed	Changes the shutter speed.	Page 43
	Aperture	Adjusts the aperture.	Page 43
	Pre-record CS Shots	Specifies the number of pre-recorded CS shots.	Page 63
	Art Effect	Adjusts the intensity of the effect.	Page 72
Control Dial*3	Exposure	Corrects brightness.	Page 52
	White Balance	Adjusts hue.	Page 46
	ISO	Changes the ISO sensitivity setting.	Page 50
	ISO High Limit	Specifies the ISO sensitivity high limit.	Page 116
	Self-timer	Selects the self-timer time.	Page 45
	Focus	Changes the focus mode.	Page 48
	Off	No function assigned to the dial.	

Operation	Setting	Description	See page:
L/R Key*4	CS	Enters the CS Mode.	Page 61
	Exposure	Corrects brightness.	Page 52
	White Balance	Adjusts hue.	Page 46
	ISO	Changes the ISO sensitivity setting.	Page 50
	Metering	Changes the Metering Mode.	Page 55
	Self-timer	Selects the self-timer time.	Page 45
	Motion Shutter	Specifies the Motion Shutter activation operation.	Page 66
	Off	No function assigned to the [◀] and [▶] keys.	

*1 Functions that can be assigned depend on the recording mode.

*2 Configure the settings below in order to directly adjust focus with the function ring.

Focus Mode: MF (Manual Focus)

Face Detection: Off

Make-up

Skin Tone: Natural

Other Items: 0

*3 The control dial operates as described below in the **M** (Manual Exposure) recording mode.

- When a function other than “Aperture” is assigned to the function ring (page 113), rotating the control dial adjusts aperture.
- When “Aperture” is assigned to the function ring, rotating the dial adjusts shutter speed.

*4 The functions of the left and right keys change as described below when certain settings are selected, even if you assigned different functions to the keys.

- When “MF” is selected as the focus mode, the left and right keys perform focus adjustment.
- When “ Multi” is selected as the AF area setting, the left and right keys shift the focus area.

NOTE

- The same function cannot be assigned to multiple controllers (keys, control dial).
- Depending on the recording mode, some functions may not be assignable to the Control Dial.

Horizontally Flipping the Recording Image (L/R Flip Shot)

Menu item: L/R Flip Shot

Shooting a snapshot while “On” is selected for this function will save an image of what is displayed on the monitor screen. This function is enabled only while the monitor screen is tilted 180°.

NOTE

- L/R flipping is not performed during movie recording.
- Images already stored in camera memory cannot be L/R flipped.
- Horizontally flipped recording cannot be used with the functions below.
Art Shot Bracketing, Interval Shot, Prerecord (Movie), Time Lapse, Slide Panorama, Wide Shot, RAW Image

Using the Self-timer (Self-timer)

Menu item: Self-timer

For details, see the Control Panel procedure on page 45.

Correcting Image Brightness (Exposure)

Menu item: Exposure

For details, see the Control Panel procedure on page 52.

Adjusting White Balance (White Balance)

Menu item: White Balance

For details, see the Control Panel procedure on page 46.

Specifying ISO Sensitivity (ISO)

Menu item: ISO

For details, see the Control Panel procedure on page 50.

Specifying the ISO Sensitivity Upper Limit (ISO High Limit)

Menu item: ISO High Limit

Settings	REC Screen Icon Display	Description
Auto	None	Shoots using the ISO sensitivity setting specified by the "ISO Sensitivity" setting (page 50).
ISO 200	ISO 200	The setting selected here becomes the ISO sensitivity upper limit when "Auto" is selected for the "ISO Sensitivity" setting (page 50).
ISO 400	ISO 400	
ISO 800	ISO 800	
ISO 1600	ISO 1600	
ISO 3200	ISO 3200	
ISO 6400	ISO 6400	

NOTE

- When the "ISO Sensitivity" setting (page 50) is something other than "Auto", the "ISO High Limit" setting is ignored, and shooting is performed using the option selected for the "ISO Sensitivity" setting.
- The camera automatically selects the following settings while "HS Night Shot" (page 89) is being used.
Auto, ISO 1600, ISO 3200, ISO 6400, ISO 12800, ISO 25600
- The "ISO High Limit" setting cannot be configured while any one of the recording mode below is in use.
Premium Auto Pro, M mode, some BEST SHOT scenes

Selecting a Focus Mode (Focus)

Menu item: Focus











For details, see the Control Panel procedure on page 48.

Specifying the Auto Focus Area (AF Area)

Menu item: AF Area

You can use the following procedure to change the Auto Focus metering area for shooting snapshots.

- When recording movies, the AF metering area is always “[] Spot”.

Settings	Description
 Intelligent	The camera automatically determines the focus area on the screen and focuses there (intelligent AF). <ul style="list-style-type: none">• Face detection (page 118) operates automatically.
 Spot	This mode takes readings of a small area in the center of the image. This setting works well with focus lock (page 49).
 Multi	When you half-press the shutter button while this setting selected, the camera will select the optimum Auto Focus area from among nine possible areas. The focus frame of the area where the camera focuses will be displayed in green. The steps below can be used to shift the position of the nine Auto Focus areas. ① While in record standby, press [] or []. ② Use [], [], [], and [] to shift the focus areas. <ul style="list-style-type: none">• Rotating the zoom controller will cause only the center focus area to become selected. ③ When the Auto Focus area is in the position you want, press [SET].
 Tracking	When you half-press the shutter button while this setting is selected, the focus frame will follow the movement of the subject.

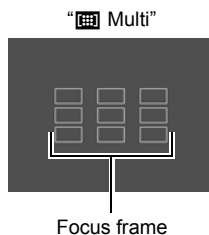
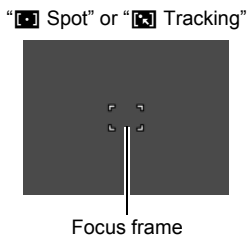
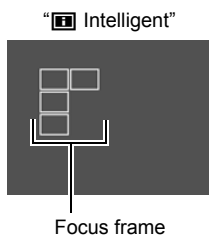

IMPORTANT!

- Auto Focus is disabled when “MF” (Manual Focus) is selected for the focus mode (page 48), even if you select an AF area.
- Selecting “ Tracking” can cause vibration and noise to occur due to lens operation while tracking a subject. This does not indicate malfunction.

- With some BEST SHOT scenes, there are restrictions on the use of AF area settings. Because of this, you may not be able to use certain settings or you may not be able to specify any AF Area setting.
- When the AF area setting is "Multi", the left and right keys shift the focus area. Functions you assigned to the left and right keys with Key Customize "L/R Key" (page 113) are not available at this time.

Shooting with Face Detection (Face Detection)

Menu item: Face Detection

When shooting people, the face detection feature detects the faces of up to ten individuals and adjusts focus and brightness accordingly.

1. Use [▲] and [▼] to select "On" and then press [SET].

2. Point the camera at the subject(s).

The camera will detect human faces and display a frame around each one.



3. Half-press the shutter button.

The camera will focus and the frames around the faces it focuses on will turn green.

4. Press the shutter button the rest of the way down.

Tips for Best Face Detection Results

- If the camera cannot detect a face, focusing is performed in accordance with the AF Area setting (page 117).
- Always make sure that Auto Focus (AF) is selected as the focus mode when shooting with face detection.
- Detection of the following types of faces is not supported.
 - A face that is obstructed by hair, sunglasses, a hat, etc., or a face in dark shade
 - A profile or a face that is at an angle
 - A face that is very far away and small, or very close and large
 - A face in an area that is very dark
 - A face of a pet or some other non-human subject

IMPORTANT!

- Face detection cannot be used in combination with any of the following features.
 - Some BEST SHOT scenes
 - Some Art Shot scenes
 - Movie recording (Including some BEST SHOT scenes that support High Speed Movie recording)
 - High Speed CS with Prerecord CS (Including some BEST SHOT scenes that support High Speed CS recording)
- The “Focus” setting is always fixed at “AF” (Auto Focus) whenever “Face Detection” is being used. If you want to change the “Focus” setting, first select “Off” for “Face Detection”.

Recording Beautiful Portraits (Make-up)

Menu item: Make-up

For details, see the Control Panel procedure on page 51.

Shooting with Continuous Auto Focus (Continuous AF)

Menu item: Continuous AF

When shooting a snapshot while “On” is selected for Continuous AF, Auto Focus is performed and focusing is continually updated until you half-press the shutter button.

- Shooting with Continuous AF can cause vibration and noise to occur due to lens operation. This does not indicate malfunction.

Specifying the Metering Mode (Metering)



Menu item: Metering

For details, see the Control Panel procedure on page 55.

Reducing the Effects of Camera and Subject Movement (Anti-shake Functions)

Menu item: Anti-shake Functions

You can turn on the camera’s Anti-shake Functions feature to reduce image blur due to subject movement or camera movement when shooting a moving subject using telephoto, when shooting a fast-moving subject, or when shooting under dim lighting conditions.





Settings	REC Screen Icon Display	Description
Strong		While applying hand shake correction, shutter speed faster than “Standard” also further reduces subject blur. Also, ISO sensitivity may be raised from “Standard”. This setting can be used while the recording mode is Program Auto (except for High Speed CS), Premium Auto Pro or HS Anti Shake.
Standard		Dramatically reduces the effects of hand movement.
Off	None	Turns off Anti Shake settings.

NOTE

- Only camera shake correction can be used during FHD and STD movie recording.
- Anti-shake Functions is not supported during High Speed Movie, HDR Art Movie recording or Time Lapse.
- Images recorded with “Strong” selected for Anti-shake Functions may appear somewhat coarser and slightly lower quality than normal.
- Image Stabilization may not be able to eliminate the effects of camera or subject movement when movement is severe.
- Image Stabilization may not work properly when the camera is mounted on a tripod. Turn off Anti-shake Functions.
- Even if “Strong” is selected for the Anti-shake Functions setting, some shooting conditions may make it impossible to achieve the desired Anti Shake results.
- While shooting with some recording modes, the “Strong” setting will be dimmed on the Anti-shake Functions menu. This means that “Strong” cannot be used with the current recording mode.

To select the snapshot image size (Image Size)

Menu item: Image Size

Image Size (Pixels)	REC Screen Icon Display	Suggested Print Size and Application	Description
12M (4000×3000)		Poster	Good detail for better clarity even for images cropped (page 154) from the original
3:2 (4000×2656)		Poster	
16:9 (4000×2240)		HDTV	
8M (3264×2448)		A4 Print	Good detail
3M (2048×1536)		3.5"×5" Print	Best when preserving memory capacity is relatively more important than image quality.

- The initial factory default image size setting is "12M".
- Selecting "3:2" records images with an aspect ratio of 3:2, which matches the standard aspect ratio of print paper.
- The letters "HDTV" stand for "High Definition Television". An HDTV screen has an aspect ratio of 16:9. Your camera can record images that are compatible with the aspect ratio an HDTV screen.
- You should regard the print paper sizes suggested here as guidelines only.
- Available image sizes are limited for some functions as noted below.

3:2, 16:9	These image sizes cannot be selected when using "High Speed CS" or "HS Night Shot". Selecting "3:2" or "16:9" in another mode and then switching to "High Speed CS" or "HS Night Shot" will cause the image size to change to "12M" automatically.
----------------------	--

■ Pixels and image size

A digital camera image is a collection of small dots called “pixels”. The more pixels there are in an image, the more detail there will be. However, you generally can do with fewer pixels when printing an image (L size) through a print service, attaching an image to e-mail, when viewing the image on a computer, etc. The size of an image indicates how many pixels it contains, and is expressed as horizontal pixels×vertical pixels.

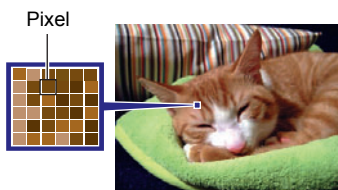

Example:

Image size	Pixels
12M	4000×3000 (Approximately 12 million pixels)
3M	2048×1536 (Approximately 3 million pixels)

- Note that larger images have more pixels, so they take up more memory space.
- For information about image size, image quality, and number of images that can be stored, see page 239.
- For information about movie image size, see page 123.
- For information about resizing existing snapshots, see page 154.

|| Specifying Snapshot Image Quality (Image Quality)

Menu item: Image Quality









Setting	REC Screen Icon Display	Description
Fine	F	Gives image quality priority.
Normal	N	Normal

- The “Fine” setting helps to bring out details when shooting a finely detailed image of nature that includes dense tree branches or leaves, or an image of a complex pattern.
- Memory capacity (the number of images you can record) will be affected by the quality settings you configure (page 239).

Movie Image Quality Settings (Movie Quality)

Menu item: Movie Quality

This setting can be used to configure movie image quality settings and to select the movie recording mode (either normal movie recording or High Speed Movie recording).

Settings (Quality (pixels))	REC Screen Icon Display	Approximate Data Rate (Frame Rate)	Description
FHD		14.2 Megabits/second (30 frames/second)	Select this setting to record high-definition (FHD) movies (page 77). The aspect ratio of movies recorded with this setting is 16:9.
HD		10.9 Megabits/second (12, 15, 20, 30 frames/second)	Select this setting when shooting with Art Shot (page 71) or with a Time Lapse (page 105) Art Shot scene, or when shooting a high definition movie (HD movie). The aspect ratio of movies recorded with this setting is 16:9. <ul style="list-style-type: none"> The frame rate depends on the currently selected scene.
STD		3.9 Megabits/second (30 frames/second)	Use this setting for standard movie recording. Recording with this setting is performed using an aspect ratio of 4:3.
HS1000		40.0 Megabits/second (1000 frames/second)	The image size of movies recorded with this mode depends on the frame rate (recording speed (page 81)).
HS480		40.0 Megabits/second (480 frames/second)	
HS240		40.0 Megabits/second (240 frames/second)	
HS120		40.0 Megabits/second (120 frames/second)	
HS30-240		5.4 Megabits/second (30 frames/second)	
		40.4 Megabits/second (240 frames/second)	
HS30-120		10.4 Megabits/second (30 frames/second)	
		40.4 Megabits/second (120 frames/second)	

Optimizing Image Brightness (Lighting)

Menu item: **Lighting**

You can use this setting to optimize the balance between bright areas and dark areas when shooting images.

Settings	Description
On	Performs brightness correction.
Off	Does not perform brightness correction.

Controlling Image Sharpness (Sharpness)

Menu item: **Sharpness**

You can specify one of five sharpness settings from +2 (sharpest) to -2 (least sharp).

Controlling Color Saturation (Saturation)

Menu item: **Saturation**

You can specify one of five saturation settings from +2 (most saturated) to -2 (least saturated).

Adjusting Image Contrast (Contrast)

Menu item: Contrast

You can specify one of five contrast settings from +2 (most contrast between light and dark) to -2 (least contrast between light and dark).

Specifying Flash Intensity (Flash Intensity)

Menu item: Flash Intensity

You can specify flash intensity to one of five levels from +2 (brightest flash) to -2 (least bright flash).

- Flash intensity may not change when the subject is too far away or too close.

Zooming with Super Resolution (Zoom (SR))

Menu item: Zoom (SR)

See page 59 for details.

Turning Digital Zoom On or Off (Digital Zoom)

Menu item: Digital Zoom

Select "On" when you want to use digital zoom (page 56).

- Digital zoom is disabled while shooting with the following feature.
 - High speed movie recording, Some BEST SHOT scenes, Wide View Photo, Interval Shot

Using the Auto Focus Assist Light (AF Assist Light)

Menu item: AF Assist Light

Half-pressing the shutter button while this setting is selected causes the front lamp to light, which provides illumination for focusing in areas where lighting is dim.

- Leaving this function turned off is recommended when shooting portraits from short distances, etc.

IMPORTANT!

- Never look directly into the front lamp or point it at the eyes of a person while it is lit.
- Make sure your finger is not covering the front lamp.

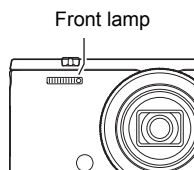

Saving a Second Normal Image When Shooting With HDR Art (Double (HDR ART))

Menu item: Double (HDR Art)

See page 73 for details.

Reducing Wind Noise during Movie Recording (Wind Noise Cut)

Menu item: Wind Noise Cut

Select "On" to reduce wind noise during movie recording. Note, however, that this will also cause the sound quality to change.

Turning on Image Review (Review)

Menu item: Review

While Review is turned on, the camera will display an image for about one second immediately after it is recorded.

Type 1	Displays a full-screen view of the image.
Type 2, Type 3	Displays a partial-screen view of the image. The difference between Type 2 and Type 3 is the way the image appears on the display.
Off	Turns off review image display.

- When shooting with some functions while "Type 1" is selected will cause the message "Busy... Please wait..." to appear after you press the shutter button. Shooting another image is disabled while this message is displayed. Wait a while until the process being performed is complete.
- The Review image may not appear when shooting with some recording modes.
- When shooting with the following modes or functions, the Review image is displayed as "Type 2" if "Type 1" is selected as the Review image type.
 - High Speed CS, AF CS, Triple Shot (BEST SHOT)
 - Art Shot Bracketing (Art Shot)
- Shooting an "HDR Art" image while "On" is selected for the "Double (HDR Art)" setting and Review is enabled will cause both the "Art Shot" image and the normal image to be displayed as the Review image.

Using Icon Help (Icon Help)

Menu item: Icon Help

While Icon Help is turned on, a textual description will appear on the display for certain icons when you switch between REC functions.



Functions Supported by Icon Help

- Recording mode
- Available options for the “Function Ring”, “Control Dial” and “L/R Key” settings
- Exposure warning when shutter button is half-pressed

Changing the Monitor Screen when Recording (Shooting Info)

Menu item: Shooting Info

You can use the above procedure to display a grid or histogram, or the movie shooting range on the monitor screen during recording.

Grid	Selecting “On” for this setting displays grid lines. The grid lines provide references that help you keep the camera vertically and horizontally straight.	
Histogram	Selecting “On” for this setting displays a histogram. This histogram lets you view exposure information while shooting. NOTE <ul style="list-style-type: none">• Use of the flash and certain shooting conditions can cause the histogram to indicate exposure that is different from the actual exposure of the image when it is shot.• The histogram cannot be displayed during movie recording.	 <p>Histogram</p>
Movie Range	Selecting “On” for this setting displays a semitransparent gray frame. The area within the frame is what is recorded as the movie.	 <p>Semi-transparent gray frame</p>

■ How to Use the Histogram

A histogram is a graph that represents the lightness of an image in terms of the number of pixels. The vertical axis indicates the number of pixels, while the horizontal axis indicates lightness. If the histogram appears too lopsided for some reason, you can use Exposure Compensation to move it left or right in order to achieve better balance. Optimum exposure can be achieved by EV shifting so the graph is as close to the center as possible. For snapshots, you can even display individual histograms for R (red), G (green), and B (blue).

Example Histograms

A histogram towards the left side results when the overall image is dark. A histogram that is too far to the left may result in “black out” of the dark areas of an image.

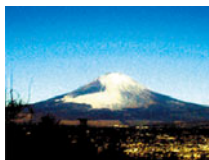

A histogram towards the right side results when the overall image is light. A histogram that is too far to the right may result in “white out” of the light areas of an image.



An overall well-balanced histogram results when the overall image is at optimal lightness.



NOTE

- A centered histogram does not necessarily guarantee optimum exposure. The recorded image may be over-exposed or under-exposed, even though its histogram is centered.
- Due to the limitations of exposure compensation, you may not be able to achieve an optimum histogram configuration.

Configuring Power On Default Settings (Memory)

Menu item: Memory

This setting lets you specify which camera settings should be remembered by the camera when it is turned off, and restored the next time the camera is turned on. To have the camera remember a setting, you should enable the setting's memory. Any setting whose memory is disabled will be reset to its initial default any time the camera is turned off.

Setting	Disabled (Initial Default Setting)	Enabled
Function Ring	Initial Default Items (Remembered for each REC mode.)	Setting at power off
CS	Off	
Flash	Auto	
Focus	AF	
ISO	Auto	
White Balance	Auto WB	
Exposure	0.0	
AF Area	Spot	
Metering	Multi	
Self-timer	Off	
Flash Intensity	0	
Zoom (SR)	Single	
Digital Zoom	On	
MF Position	Position before manual focus was selected.	
Zoom Position	Full wide (Optical zoom setting only.)	

Viewing Snapshots and Movies

Viewing Snapshots

See page 38 for the procedure for viewing snapshots.

Viewing a Movie

1. In the PLAY mode, use [◀] and [▶] to display the movie you want to view.
2. Press [●] (Movie) to start playback.

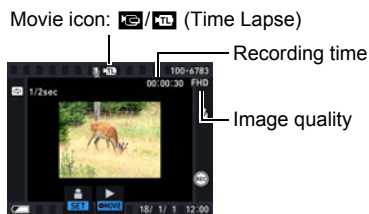

Movie Playback Controls

Fast forward/fast reverse	[◀] [▶] (Playback in progress.) <ul style="list-style-type: none">• Each press of either button increases the speed of the fast forward or fast reverse operation.• You can also perform this operation using the function ring.• To return to normal playback speed, press [▼].
Play/pause	[SET]
1 frame forward/back	[◀] [▶] (Playback paused.) <ul style="list-style-type: none">• Holding down either button scrolls continuously.• You can also perform this operation using the function ring.
Volume adjustment	Press [▼] and then press [▲] [▼]. <ul style="list-style-type: none">• Volume can be adjusted only while movie playback is in progress.
Information display on/off	[▲] (DISP)
Change to normal playback speed during high speed movie playback (slow playback)	[●] (Movie) <ul style="list-style-type: none">• Press [●] (Movie) again to return to the slow playback. This operation is not supported when playing a movie shot with "HS30-120" or "HS30-240".

Zoom	Rotate the zoom controller in the direction of [Q] (Q). <ul style="list-style-type: none"> You can use [▲], [▼], [◀], and [▶] to scroll the zoomed image on the monitor screen. You can zoom a movie image up to 4.5 times normal size. You can also perform this operation using the function ring.
Stop playback	[MENU]

- Playback may not be possible for movies not recorded with this camera.
- A movie that has been rotated using "Rotation" (page 153) or "Auto Rotate" (page 196) cannot be zoomed.

Viewing a Panorama Image

1. In the PLAY mode, use **[◀] and **[▶]** to display the panorama images you want to view.**

2. Press **[●] (Movie) to start playback of the panorama.**

Panorama playback causes the image to scroll left, right, up, or down.



Playback Controls

To start or pause playback	[SET]
To advance scroll while paused	[◀] [▶] (When the slide direction is left or right.) [▲] [▼] (When the slide direction is up or down.) <ul style="list-style-type: none"> Holding down any button scrolls continuously.
To hide or show display information	[▲] (DISP)
To stop playback	[MENU]

- The following functions cannot be performed on a panorama image. MOTION PRINT, Movie Editing, Trimming, Resize, Lighting, White Balance, Brightness, Rotation

Viewing Continuous Shutter Images

Each time you shoot with continuous shutter (CS) or Interval Shot, the camera creates a group that includes all of the images for that particular session. You can use the following procedure to play back the images in a particular group.

1. In the **PLAY** mode, use [**◀**] and [**▶**] to display the group whose images you want to view.





2. Press [**●**] (**Movie**) to start playback.

Current image number/number of images in the group



Playback Controls

[◀] [▶]	During playback, changes the playback direction and playback speed. While playback is paused, scrolls forward or back. <ul style="list-style-type: none">• You can also perform this operation using the function ring.• Playback speed cannot be adjusted while the displayed image is zoomed.
[SET]	Toggles between pause and play.
Zoom controller	Zooms the image. <ul style="list-style-type: none">• You can use [▲], [▼], [◀], and [▶] to scroll the zoomed image on the monitor screen.• Rotating the zoom controller towards  () while an image is not zoomed will display a menu of images in the current CS group.

[MENU]	Exits group playback.
[▲] (DISP)	Cycles through information display formats.
[▼]	Displays the “Edit Group” menu.

Deleting CS Images

You can use the following procedures to delete CS images while playback is in progress or paused.

1. While playback of a CS or interval group is in progress or paused, press [▼].

- This will display the “Edit Group” menu.

2. Use [▲] and [▼] to select “Delete” and then press [SET].

3. Use [▲] and [▼] to select the delete operation type and then press [SET].

Delete	<p>Deletes a specific file.</p> <ol style="list-style-type: none"> ① Use [◀] and [▶] to display the file you want to delete. ② Use [▲] and [▼] to select “Delete” and then press [SET]. <ul style="list-style-type: none"> • To delete other files, repeat steps ① and ②. ③ Press [MENU] to exit the delete operation.
Delete Frames	<p>Deletes multiple files.</p> <ol style="list-style-type: none"> ① Use [▲], [▼], [◀], and [▶] to move the selection boundary to a file you want to delete, and then press [SET]. <ul style="list-style-type: none"> • This will cause the check box in the lower left corner of the selected file’s thumbnail to become selected. • You can zoom in on the image by rotating the zoom controller towards [⏏] (Q). ② Repeat step ① to select other files, if you want. ③ After selecting all of the files you want to delete, press [MENU]. ④ Use [▲] and [▼] to select “Yes”, and then press [SET]. <ul style="list-style-type: none"> • This deletes the files you selected. • To cancel the delete operation, select “No” and then press [SET].
Del Group Images	<p>Deletes all the files in a group.</p> <ol style="list-style-type: none"> ① Use [▲] and [▼] to select “Yes”, and then press [SET].

Dividing Up an Image Group

Use the procedure below to divide up a CS Group into individual images.



IMPORTANT!

- Once a CS group is divided, it cannot be regrouped.

- 1. In the PLAY mode, press [MENU].**
- 2. Press [◀], use [▲] and [▼] to select the “▶ PLAY MENU” tab, and then press [▶].**
- 3. Use [▲] and [▼] to select “Divide Group” and then press [▶].**
- 4. Use [▲] and [▼] to select the image group to be divided and then press [SET].**

Select File	Divides a specific CS group. ① Use [◀] and [▶] to display the CS group you want to divide up. ② Use [▲] and [▼] to select “Divide” and then press [SET]. <ul style="list-style-type: none">• To delete another CS group, repeat steps ① and ②.
All Files	Divides all CS groups. ① Use [▲] and [▼] to select “Yes”, and then press [SET].

Copying an Image in a Group (Copy)

Use the following procedure to copy an image in a group to a location outside of the group.

- 1. While CS or interval shot group playback is in progress or paused, press [▼].**

This will display the “Edit Group” menu.

- 2. Use [▲] and [▼] to select “Copy”, and then press [SET].**

- 3. Use [◀] and [▶] to display the image you want to copy.**

- 4. Use [▲] and [▼] to select “Copy”, and then press [SET].**

NOTE

- The functions below cannot be performed on snapshots inside a group. Before using either of these functions, perform the above procedure to copy the image first.

White Balance, Brightness, Trimming, Rotation, Resize

Zooming an On-screen Image

1. In the PLAY mode, use [◀] and [▶] to scroll through the images until the one you want is displayed.

2. Rotate the zoom controller towards [📏] (🔍) to zoom.

You can use [▲], [▼], [◀], and [▶] to scroll the zoomed image on the monitor screen. You can also use the control dial to scroll upwards and downwards, and the function ring to scroll left and right. Rotate the zoom controller towards [📏] to unzoom the image.

- When monitor screen contents are turned on, a graphic in the lower right corner of the screen shows what part of the zoomed image is currently displayed.
- To exit the zoom screen, press [MENU].
- Though the maximum image zoom factor is 8X, certain image sizes may not allow zooming up to the full 8X.
- Pressing [SET] will lock the current zoom factor for the on-screen image. You can then use [◀] and [▶] to scroll between images, using the same zoom factor. Pressing [SET] again will unlock the zoom factor and allow you to use [▲], [▼], [◀] and [▶] to move around the currently displayed images. This function cannot be used while viewing CS group images or movies. Also, CS group images and movies will not appear when you are scrolling images with [◀] and [▶].

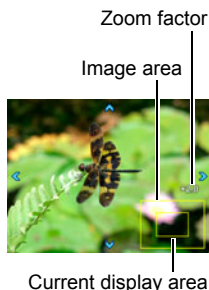

Displaying the Image Menu

1. In the PLAY mode, rotate the zoom controller towards [📏] (🔍).

Use [▲], [▼], [◀] and [▶] to move the selection boundary around the image menu.

To view a particular image, use [▲], [▼], [◀], or [▶] to move the selection boundary to the image you want and then press [SET].

- In the case of a movie or a continuous shutter (CS) file, the first frame of the file will be displayed.
- You can scroll forward and back between image menu pages by rotating the function ring.
- A question mark (?) will be displayed for images that cannot be displayed for some reason.



Viewing Snapshots and Movies on a TV Screen

- 1. Use a commercially available HDMI cable to connect the camera to the TV (page 108).**

IMPORTANT!

- Output to a TV is not supported while the camera is in the REC mode except for "HDMI TV Output" (page 108).

-
- 2. Turn on the TV and select its HDMI input mode.**

If the TV has more than one video input, select the one where the camera is connected.

-
- 3. Turn on the camera and press [▶] (PLAY).**

This will cause an image to appear on the TV screen, without anything appearing on the camera's monitor screen.

-
- 4. Now you can display images and play back movies as you normally do.**

IMPORTANT!

- Audio is initially output by the camera at maximum volume. When you first start displaying images, set the TV volume control at a relatively low level and then adjust it as required.

NOTE

- Use a HDMI cable that with a plug that is compatible with the camera's HDMI micro connector on one end, and a plug that is compatible with your TV's HDMI connector on the other end.
- Proper image and/or audio output and other operations may not be possible with some devices.
- Connecting the camera to the HDMI connector of another device can damage both the camera and the other device. Never connect two HDMI output connectors to each other.
- Disconnect the HDMI cable when you are not using HDMI output. The camera's monitor screen may not operate normally while the HDMI cable is connected.
- Audio is stereo.

■ Selecting the HDMI Terminal Output Method (HDMI Output)

Use this setting to select the digital signal format when connecting to a TV with an HDMI cable.

1. In the **PLAY** mode, press **[MENU]**.
2. Press **[◀]**, use **[▲]** and **[▼]** to select the “**⚙️ SETTING**” tab, and then press **[▶]**.
3. Use **[▲]** and **[▼]** to select “**HDMI Output**”, and then press **[▶]**.
4. Use **[▲]** and **[▼]** to select the output method, press **[SET]**.

Auto	This setting will cause the format to change automatically in accordance with the connected TV. Normally, you should use this mode.
1080i	1080i format output*
480p	480p format output
576p	576p format output

- * 1080i corresponds to 1080 60i, but not 1080 50i. Because of this, the required output method may be 576p when outputting to a digital TV in a PAL reception area that does not support 1080i 60i. If you are in a PAL reception area and nothing is displayed automatically, change the setting to 576p.
- If an image does not appear when “Auto” is selected as the output method, try changing this setting to something else.



IMPORTANT!

- The “HDMI Output” setting cannot be changed as long as there is an HDMI cable connection between the camera and a TV. Disconnect the HDMI cable from the camera to change the “HDMI Output” setting.

Other Playback Functions (PLAY MENU)

Using the Menu Screen to Select a Playback Operation and Configure Settings

This section explains menu items that you can use to configure settings and perform other playback operations.

1. In the PLAY mode, press [MENU].
This will display the menu screen (▶ PLAY MENU).
2. Press [◀], use [▲] and [▼] to select the “▶ PLAY MENU” tab, and then press [▶] or [SET].
3. Select the operation or setting item you want, and configure its setting as desired.
 - For information about menu operations, see page 32.



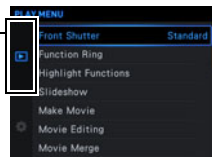

“▶ PLAY MENU” tab



Assigning a Function to the Front Shutter Button (Front Shutter)

Menu item: Front Shutter

This setting can be used to assign the function to be performed when the front shutter button is pressed while the camera is in the PLAY mode.

Setting	PLAYScreen Icon Display	Description (When front shutter button is pressed)
Standard		Enters the REC mode.
Slideshow		Starts a slideshow (page 144).
Copy Group Image		Copies the currently displayed image in a group to a location outside of the group (page 135).
Off		No operation performed.

Scrolling Images at High Speed or by Recording Date (Function Ring)

Menu item: Function Ring

You can rotate the function ring to scroll images at high speed or by recording date.

Setting	Description
10 images	Scrolls forward or back by the specified number of images.
25 images	
50 images	
100 images	
Date	Scrolls images by recording date.

Creating a Photograph or Movie of Selected Images (Highlight Functions)

■ Creating a Movie of a Day's Images (Highlight Movie)

Menu item: Highlight Functions → Highlight Movie

You can configure camera settings to automatically select snapshot and movie highlights, and create a movie of them. Images included in a Highlight Movie are selected based on their highlight scores and shooting condition information recorded along with the images.

- You can use the Highlight Score function (page 143) to change the highlight score of a snapshot.
- The playback time and effects applied to the Highlight Movie are automatically determined based on the shooting condition information recorded along with the images included in the movie and their highlight score (+1 or 0).

- 1. Use [▲] and [▼] to select the recording date of the snapshots and movies you want to use and then press [SET].**

- 2. Use [▲] and [▼] to select a movie length and then press [SET].**

- 3. Use [▲] and [▼] to select a background music setting and then press [SET].**
 - To hear what a background music setting sounds like, press [▶].

- 4. Use [▲] and [▼] to select "Create" and then press [SET].**

This creates and save the Highlight Movie, and displays it on the monitor screen.

 - Pressing [MENU] while creation of a Highlight Movie is in progress will stop Highlight Movie creation. No movie is saved if you stop Highlight Movie creation.

NOTE

- An image whose highlight score is "0" is never included in a Highlight Movie.
- A Highlight Movie is FHD movie quality, with an aspect ratio of 16:9. If an image with an aspect ratio that is not 16:9 is incorporated into a Highlight Movie, the top and bottom of the image will be cropped as required.
- If a portrait orientation image is incorporated in to a Highlight Movie, there will be black bands on the left and right of the image.
- When there is a total of more than 9,999 snapshot and movie files shot on the same date, Highlight Movie will select photos and movies from the files numbered 1 to 9999.
- Depending on the number of files and other factors when a Highlight Movie is being created, the creation operation may take some time.
- Only FHD quality movies that were recorded with this camera can be used in a Highlight Movie. The types of movies below cannot be used in a Highlight Movie, even if they are recorded with this camera.
 - Movies less than two seconds long
 - Movies recorded with Time Lapse

■ Creating a Collage of a Day's Snapshots (Highlight Photo)

Menu item: Highlight Functions → Highlight Photo

You can configure camera settings to automatically select snapshot highlights and generate a collage of them. The snapshots included in a Highlight Photo are selected automatically based on their high light scores and shooting condition information recorded along with the snapshots.

- You can use the Highlight Score function (page 143) to change the highlight score of a snapshot.

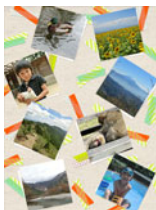

1. Use [▲] and [▼] to select the recording date of the snapshots you want to use and then press [SET].

2. Use [◀] and [▶] to select the layout you want and then press [SET].

This creates and stores the Highlight Photo.

3. Use [▲] and [▼] to select “Complete” and then press [SET].

- If you want the camera to randomly select different images from among those on the selected recording date, use [▲] and [▼] to select “Shuffle”, and then press [SET]. This will also delete the previously created Highlight Photo.



NOTE

- An image whose highlight score is “0” is never included in a Highlight Photo.
- When there are more than 9,999 snapshots shot on the same date stored on the memory card, Highlight Photo will select photos from those numbered 1 to 9999.
- The Highlight Photo operation may not be possible while battery power is low.
- Highlight Photo automatically selects snapshots to be included in the Highlight Photo. You cannot specify the snapshots to be used.
- The types of images below cannot be included in a Highlight Photo.
Panorama image, Movies
- Highlight Photo may not work if there is a snapshot in camera memory that cannot be displayed by the camera. In this case, the error message “There are not enough images for this operation.” will appear.

■ Changing the Highlight Score of an Image (Highlight Score)

Menu item: **Highlight Functions** → **Highlight Score**

You can use the procedure below to change the highlight score of a snapshot or movie.

Highlight Score	Description
 (+1)	No score assigned (default) An image with this score may be selected for a Highlight Snapshot or Highlight Movie.
 (+2)	An image with this score is given priority for Highlight Snapshot or Highlight Movie selection.
 (0)	An image with this score is never selected for a Highlight Snapshot or Highlight Movie.

1. Use [▲], [▼], [◀], and [▶] to move the selection boundary to the image whose highlight score you want to change.

- You can switch from the multi-image menu to a view of the currently selected image by sliding the zoom slider.

2. Press [SET] to change the highlight score of the currently selected image.

- Each press of [SET] cycles through the highlight scores in the following sequence: "★" (+1), "★" (+2), "★" (0).
- While a single image is displayed, you can also change the highlight score by using [SET], or [▲] and [▼].

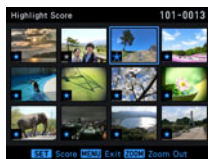









3. After the highlight score is the way you want, press [MENU].

NOTE

- The highlight score function can be used only with snapshots and movies recorded with this camera.
- The highlight scores of the types of images below cannot be changed.
 - Protected images
 - Movies recorded with the following image sizes: STD, HS120, HS240, HS480, HS1000, HS30-120, HS30-240
 - Movies recorded with Art Shot
 - Movies recorded with Time Lapse

Playing a Slideshow on the Camera (Slideshow)

Menu item: Slideshow

Start
Starts the slideshow
Images
Specifies the type of images to be included in the slideshow All images: Snapshots, movies, continuous shutter images All except  : All non-continuous shutter (CS) images  Only: Snapshots only  Only: Movies only  Only: Timelapse only
Time
Time from the start to the end of the slideshow 3 minutes, 5 minutes, 10 minutes, 15 minutes, 30 minutes, 60 minutes
Interval
Amount of time each image remains displayed Use [] and [] to select one of the following settings: 1, 3, 5, 10, 15, 20, or 30 seconds, or "MAX". If you specify a value other than "MAX", movies and CS images play from beginning to end. When the slideshow reaches a movie or CS image file while "MAX" is selected, only the first frame of the movie will be displayed.
Effect
Select the effect you want. Pattern 1 to 5: Plays background music and applies an image change effect. <ul style="list-style-type: none">• Patterns 2 through 4 have different background music, but they all use the same image change effect.• Pattern 5 can be used for playback of snapshots only (except for those that are part of a CS group), and the "Interval" setting is ignored.• Snapshots that are part of a group are displayed the same as those shot with the single shot mode, and not as a group.• The currently selected image change effect setting is disabled automatically in following cases.<ul style="list-style-type: none">– When playing a slideshow for which " Only" or " Only" is selected for the "Images" setting– When the interval setting is "MAX" or 1 second– Before and after playback of a movie Off: No image change effect or background music

- To stop the slideshow, press [SET] or [MENU]. Pressing [MENU] stops the slideshow and returns to the menu screen.
- Adjust audio volume by pressing [▼] and then press [▲] or [▼] during playback.
- All button operations are disabled while the slideshow is transitioning from one image to another.
- The time required for transition from one image to another may be longer in the case of an image that was not recorded with this camera.

■ Transferring Music from Your Computer to Camera Memory

You can replace the built-in slideshow background music with other music from your computer.

Supported File Types:

- PCM format (16-bit, monaural / stereo) WAV files
- Sampling Frequencies: 11.025 kHz/22.05 kHz/44.1 kHz

Number of Files: 9

File names: SSBGM001.WAV to SSBGM009.WAV

- Create the music files on your computer using the above names.
- Regardless of which effect pattern you select, the music files you store in camera memory are played back in name sequence.

1. Connect the camera to your computer (pages 185, 188).

If you plan to save the music files to the camera's memory card, make sure the card is loaded in the camera.

2. Perform one of the following operations to open the memory card or built-in memory.

This will cause the camera to be recognized by your computer as a Removable Disk (Drive).

- Windows
 - ① Windows 10 users: Click "Start" and then "Explorer". Next, in the sidebar, click "PC".
Windows 8.1 users: Click "Desktop" and then "Explorer".
Windows 7 users: Click "Start" and then "Computer".
 - ② Double-click "Removable Disk".
- Macintosh
 - ① Double-click the camera's drive icon.

3. Create a folder named "SSBGM".

4. Double-click the "SSBGM" folder you created and copy the background music file to it.

- See the user documentation that comes with your computer for information about moving, copying, and deleting files.
- If there are background music files both in built-in memory and on the memory card loaded in the camera, the files on the memory card take priority.
- See page 191 for information about camera folders.

5. Disconnect the camera from the computer (pages 186, 188).

Using Snapshots to Create a Movie (Make Movie)

Menu item: Make Movie

You can use the procedure below to convert snapshots shot with this camera to a movie. Selecting a group will include all of the images in the group in one movie. You can use up to 1,000 snapshots in a movie.

1. Use [▲], [▼], [◀], and [▶] to move the blue boundary to a snapshot you want to include in the movie and then press [SET].

This will select the check box in the lower left corner of the image and move the blue boundary to the next image.

- To clear (deselect) a check box, move the blue boundary to the applicable image and then press [SET].
- Selecting a group and pressing [SET] will select all of the images in the group for inclusion in the movie.
- To view a particular image, rotate the zoom controller.

2. Repeat step 1 to select other images you want to include in the movie. After you are finished selecting images, press [MENU].

3. Use [▲] and [▼] to select the playback speed and then press [SET].

This creates a movie using the selected snapshots.

NOTE

- RAW images cannot be included in a movie.
- Movie image quality depends on the size of the snapshots.
3M and greater: FHD
2M or 1M: HD
0.8M or VGA: STD

Editing a Movie on the Camera (Movie Editing)

Menu item: **Movie Editing**

The Movie Editing feature lets you use one of the following procedures to edit out a specific part of a movie.

Previous Cut	Cuts everything from the beginning of the movie up to the current location.
Intermediate Cut	Cuts everything between two points.
Next Cut	Cuts everything from the current location to the end of the movie.

- Display the movie you want to edit before performing this operation.

1. Use [▲] and [▼] to select the editing method you want to use and then press [SET].

2. Use the following operations to select the frame (point) from which or to which you want to cut the movie (the cut point).

[◀] [▶]	During playback, changes the playback direction and playback speed. While playback is paused, scrolls forward or back. <ul style="list-style-type: none">• You can also perform this operation using the function ring.
[SET]	Toggles between pause and play.

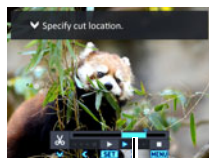

Cut range (blue)

3. Press [▼] to display the editing menu and specify one or two cut points.

Previous Cut	While the frame you want the cut to be up to is displayed, press [▼].
Intermediate Cut	<ol style="list-style-type: none">① While the frame you want the first (From) cut to be is displayed, press [▼].② Select another frame.③ While the frame you want the second (To) cut to be is displayed, press [▼].
Next Cut	While the frame you want the cut to be from is displayed, press [▼].

4. Use [▲] and [▼] to select “Yes” and then press [SET].

The selected cut operation will take considerable time to complete. Don't try to perform any camera operation until the “Busy... Please wait...” message disappears from the monitor screen. Note that a cut operation can take a long time if the movie being edited is long.



IMPORTANT!

- When you edit a movie, only the result is saved. The original movie is not retained. An editing operation cannot be undone.

NOTE

- A movie that is shorter than five seconds cannot be edited.
- Editing of movies recorded with a different type of camera is not supported.
- Movie Editing is not possible if the resulting movie is less than one second in length.
- You will not be able to edit a movie if the amount of remaining memory capacity is less than the size of the movie file you want to edit. If there is not enough memory available, delete files you no longer need to free up more.
- Splitting of a movie into two movies is not supported.
- You also can start a movie editing operation while the movie you want to edit is playing back. When playback reaches a frame where you want a cut point to be, press [SET] to pause playback. Next, press [▼] to display the menu of editing options. Perform editing using the same procedures as described above.

|| Merge two movies (Movie Merge)

Menu item: **Movie Merge**

This procedure combines two movies. The play times of the each movies must be less than 10 minutes, and the two movies must be of the same quality and frame rate. Note that merging of two High Speed Movies is not supported.

- Display one of the movies you want to merge before performing this operation.

1. Use [◀] and [▶] to select the movie you want to merge with the one that was displayed when you pressed [MENU].

Only movies that can be merged with (that are the same quality and frame rate as) the movie displayed when you pressed [MENU] will be displayed.

2. Use [▲] and [▼] to select “Create” and then press [SET].

This will create a new movie that is a combination of movie that was displayed when you pressed [MENU] and the movie you selected in step 1, above.

- The original two movies are not affected.

|| NOTE

- In the case of FHD or HD quality movies, some movies may not be able to be merged because of differences in frame rates due to the recording mode, or the Art Shot or Time Lapse scene used.
- A movie shot with another camera model cannot be merged with this function.
- The original movies are not affected when merged. Make sure the memory card you are using has sufficient unused space before using this function.
- Depending on the movies, the merge operation may take some time to complete.

|| Creating a Snapshot of a Movie Frame (MOTION PRINT)

Menu item: **MOTION PRINT**

- Display the movie that contains the frame you want to use to create a snapshot before performing this operation.

1. Use [◀] and [▶] to scroll through the movie frames and display the one you want to use as the image of the MOTION PRINT image.

Holding down [◀] or [▶] scrolls at high speed.

- You can also perform this operation using the function ring.

2. Use [▲] and [▼] to select “Create” and then press [SET].

- Only the frames of movies recorded on this camera can be used in a MOTION PRINT image.

Optimizing Image Brightness (Lighting)

Menu item: Lighting

You can use this setting to adjust the balance between bright areas and dark areas in existing images in the range of 0 (no optimization) to +2 (bright).

- Display a snapshot before performing this operation.

NOTE







- Correcting the lighting when shooting produces better results (page 124).
- Altering the lighting of an image causes the original image and the new (altered) version to be stored as separate files.
- When you display an altered image on the camera's monitor screen, the date and time indicates when the image was originally recorded, not when the image was altered.

Adjusting White Balance (White Balance)

Menu item: White Balance

You can use the white balance setting to select a light source type for a recorded image, which will affect the colors of the image.

- Display a snapshot before performing this operation.

 Daylight	Outdoors, fair weather
 Overcast	Outdoors, cloudy to rain, in tree shade, etc.
 Shade	Very high temperature light, such as building shade, etc.
 Day White Fluor	White or day white fluorescent lighting, without suppressing color cast
 Daylight Fluor	Daylight fluorescent lighting, while suppressing color cast
 Tungsten	Suppressing of the appearance of light bulb lighting
Cancel	No white balance adjustment

NOTE

- You also can adjust the white balance when recording images (page 46).
- The original snapshot is retained in memory and not deleted.
- When you display an altered image on the camera's monitor screen, the date and time indicates when the image was originally recorded, not when the image was altered.

Adjusting the Brightness of an Existing Snapshot (Brightness)

Menu item: Brightness

You can select one of five brightness levels, from +2 (brightest) to -2 (least bright).

- Display a snapshot before performing this operation.

NOTE

- The original snapshot is retained in memory and not deleted.
- When you display an altered image on the camera's monitor screen, the date and time indicates when the image was originally recorded, not when the image was altered.

Selecting Images for Printing (DPOF Printing)

Menu item: DPOF Printing

See page 179 for details.

- Display a snapshot before performing this operation.

Protecting a File Against Deletion (Protect)

Menu item: Protect

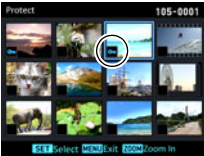
Select File	<p>Protects specific files.</p> <ol style="list-style-type: none">① Use [◀] and [▶] to select the image that you want to protect.<ul style="list-style-type: none">• To view a particular image, rotate the zoom controller.② Press [SET]. An image that is protected is indicated by the  icon.<ul style="list-style-type: none">• To unprotect a file, select an protected image and then press [SET].③ To protect other files, repeat steps ① and ②. To exit the protect operation, press [MENU].	
All Files	<p>Protects all files.</p> <ol style="list-style-type: none">① Use [▲] and [▼] to select "All Files: On" and then press [SET].② Press [MENU]. To unprotect all files, select "All Files: Off" instead of "All Files: On" in step ① and then press [SET].	



IMPORTANT!

- Note that even if a file is protected, it will be deleted if you perform the format operation (page 201).

Protecting an Image in a Group Against Deletion (Protect)

1. While playback of a CS or interval group is in progress or paused, press [▼].
 - This will display the “Edit Group” menu.
2. Use [▲] and [▼] to select “Protect” and then press [SET].
3. Use [▲] and [▼] to select the protect method you want to use and then press [SET].

Select Frames	<p>Protects specific images within a group.</p> <ol style="list-style-type: none">① Use [▲], [▼], [◀], and [▶] to move the blue selection boundary to the image you want to protect.<ul style="list-style-type: none">• You can scroll through images by rotating the zoom controller.② Press [SET].<p>This makes the image protected, which is indicated by “” on the image thumbnail.</p><ul style="list-style-type: none">• To unprotect an image, select a protected file and then press [SET].③ Press [MENU] to exit the protect operation.
Frame all	<p>Protects all the images within a group.</p> <ol style="list-style-type: none">① Use [▲] and [▼] to select “All Frames On” and then press [SET].<p>To unprotect all of the images in the group, select “All Frames Off” in step ① and then press [SET].</p>



IMPORTANT!

- Note that even if a file is protected, it will be deleted if you perform the format operation (page 201).

Editing the Date and Time of an Image (Date/Time)

Menu item: **Date/Time**

- Display a snapshot before performing this operation.

[▲] [▼]	Changes the setting at the cursor location.
[◀] [▶]	Moves the cursor between settings.

When the date and time settings are what you want, align the cursor with “Apply” and then press [SET] to apply them.

- To switch between 12-hour and 24-hour timekeeping, move the cursor to “am (pm)” and “24h” (one of which will be displayed) and then use [▲] and [▼] to change the setting.

NOTE

- The date and time stamped into an image using the Timestamp (page 195) cannot be edited.
- You cannot edit the date and time of an image that is protected.
- You can input any date from 1980 to 2049.

Rotating an Image (Rotation)

Menu item: **Rotation**

- Display a snapshot before performing this operation.

1. Use [▲] and [▼] to select “Rotate” and then press [SET].

Each press of [SET] will rotate the displayed image 90 degrees left.

2. When the displayed image is at the orientation you want, press [MENU].

NOTE

- Rotating a CS image causes all of the images in the CS group to be rotated. You cannot rotate individual component image in a CS group.
- Rotation of a panorama image is not supported.
- Note that this procedure does not actually change the image data. It simply alters how the image is displayed on the camera’s monitor screen.
- An image that has been protected or zoomed cannot be rotated.
- The original (unrotated) version of the image will be displayed on the image menu screen.

Resizing a Snapshot (Resize)

Menu item: **Resize**

You can reduce the size of a snapshot and save the result as a separate snapshot. The original snapshot is also retained. You can resize an image to one of three sizes: 8M, 3M, VGA.

- Display a snapshot before performing this operation.
- Resizing a 3:2 or 16:9 size snapshot will create an image with an aspect ratio of 4:3, with both sides cut off.
- The recording date of the resized version of the snapshot will be the same as the recording date of the original snapshot.
- A snapshot created with MOTION PRINT cannot be resized.

Cropping a Snapshot (Trimming)

Menu item: **Trimming**

You can crop a snapshot to trim parts you do not need, and save the result in a separate file. The original snapshot is also retained.

Use the zoom controller to zoom the image to the size you want, use [▲], [▼], [◀], and [▶] to display the portion of the image you want to cut out, and then press [SET].

- Display a snapshot before performing this operation.
- You also can use the function ring to change the display position.
- The image produced by cropping a 3:2 or 16:9 image will have an aspect ratio of 4:3.
- The recording date of the cropped image will be the same as the recording date of the original snapshot.

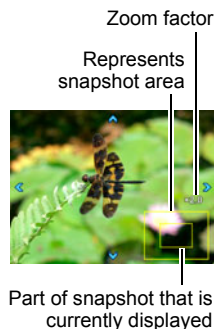

Copying Files (Copy)

Menu item: Copy

Files can be copied from the camera's built-in memory to a memory card or from a memory card to built-in memory.

- Display a snapshot before performing this operation.

Built-in → Card	Copies all files from built-in camera memory to a memory card. This option copies all the files in built-in camera memory. It cannot be used to copy a single file.
Card → Built-in	Copies a single file on the memory card to camera built-in camera memory. Files are copied to the folder in built-in memory whose name has the largest serial number. <ul style="list-style-type: none">• You cannot copy a continuous shutter (CS) group image (page 135). <ol style="list-style-type: none">① Use [◀] and [▶] to select the file you want to copy.② Use [▲] and [▼] to select "Copy" and then press [SET].

NOTE

- You can copy snapshots or movies you recorded with this camera.

Combining CS Images into a Single Still Image (CS Multi Print)

Menu item: CS Multi Print

- Display the CS group that contains the frame you want to use to create a snapshot before performing this operation.

1. Use [▲] and [▼] to select "Create".

- You can use [◀] and [▶] to select a different CS group, if you want.

2. Press [SET].

This converts the CS group to a 12M (4000×3000) image with up to 30 CS frames (5 vertical × 6 horizontal).

- This camera may not be able to correctly convert a CS group image with another camera.
- The recording date of the converted image will be the same as the recording date of the original CS group.
- When converting a CS group whose images have been rotated by the "Rotation" feature to a CS Multi Print image, the arrangement of the images in the CS Multi Print will be different from that of normal (unrotated) CS images.

Dividing Up a Group (Divide Group)

Menu item: Divide Group

See page 134 for details.

Editing the Images in a Group (Edit Group)

Menu item: Edit Group

See the following pages for details.

DPOF Printing: page 179

Protect: page 152

Copy: page 135

Delete: page 133

Connecting the Camera with a Smartphone (Wireless Connection)



Controlling Your Camera with a Smartphone

Your camera has both Bluetooth® wireless technology and wireless LAN capabilities built in. After establishing a wireless connection with a smartphone, you can perform the operations described in the table below. Requires installation of the EXILIM Connect app on your smartphone.

- Your camera can connect using Bluetooth wireless technology with a smartphone that supports Bluetooth low energy technology.
- Even if your smartphone is not Bluetooth low energy technology, you can send images to it and perform Remote Capture operations using wireless LAN. For details, see the EXILIM Connect user documentation (page 159).

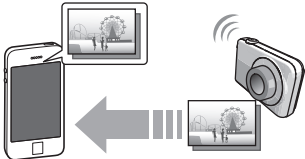
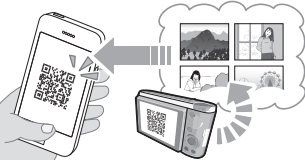
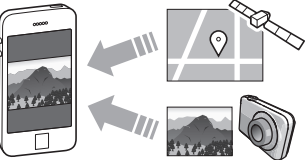

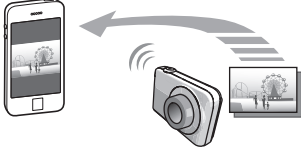
With this function:	You can do this:
Auto Send  A diagram showing a smartphone on the left and a camera on the right. A large arrow points from the camera to the smartphone. Above the camera, there is a small inset image of a landscape. A signal icon (three curved lines) is positioned between the camera and the smartphone, indicating a wireless connection.	Images can be automatically sent as they are shot to a smartphone that has been Bluetooth wireless technology paired with the camera.
One Time Share  A diagram showing a hand holding a smartphone on the left displaying a QR code. A camera is on the right, also displaying a QR code. A cloud-like shape in the background contains several small thumbnail images of different scenes, representing a library of snapshots.	Share selected snapshots for viewing on smartphones that are not paired with the camera (page 167). The Scene app needs to be installed on the smartphone in order to use One Time Share.
Add location info to snapshots  A diagram showing a smartphone on the left displaying a landscape photo. A camera is on the right. A map icon with a location pin is in the center. A satellite icon is at the top right, with an arrow pointing towards the map, representing GPS location data being added to the photo.	Configure settings to have a smartphone add shooting location information (latitude, longitude) to snapshots when they are sent from the camera (page 176).

With this function:	You can do this:
<p>Shoot with phone</p> 	<p>Remotely control and shoot with the camera using a smartphone (page 166).</p>
<p>Send to phone</p> 	<p>Send snapshots and movies recorded with your camera to your smartphone. After sending an image to a smartphone, you can then upload it from the smartphone to a social networking service (page 169).</p>
<p>View on phone</p> 	<p>View snapshots stored in camera memory on a smartphone, and copy snapshots and movies to a smartphone for viewing. You can also view snapshots and movies in camera memory on a computer, and copy them to a computer (page 170).</p>

★ IMPORTANT!

- Inside an aircraft or anywhere else where use of wireless communication is restricted or prohibited, put the camera into the airplane mode.
- Some smartphone models may not be able to play back movie files from your camera.
- Depending on your smartphone model, its operating system version, and/or its remaining storage capacity can cause failure of a movie or snapshot save operation. Receiving a camera file, perform the required operation on your smartphone to check if the file was stored properly.
- Location information is not added to snapshot data stored in camera memory.
- A movie received on an Android™ terminal:
 - Movies are not displayed by Gallery app. Movies are stored in a folder named EXILIM Connect.
 - A separate movie player is required to playback movies (whose files have the file name extension MOV).
 - Depending on your movie player, you may not be able to playback movies and/or audio.
- Images recorded on another manufacturer's camera cannot be sent using this function.

- Attempting to use a memory card that includes a wireless function with this camera can cause abnormal operation.

NOTE

- Note that using wireless functions requires more battery power usage than normal. Make sure that the camera battery is sufficiently charged before starting a wireless LAN operation.
- The operating range depends on the local communication environment and on the type of smartphone you are connected to.

■ About EXILIM Connect

For detailed information about EXILIM Connect, refer to the EXILIM Connect User's Guide (which you can download at the website below).

<http://www.exilim.com/manual/>

- Note that to view the EXILIM Connect User's Guide, you will have to install Adobe Reader. Consult CASIO authorized service center if you are unable to open to display the PDF format User's Guide.
- Note that EXILIM Connect User's Guides may not be available in all languages. If you cannot find a EXILIM Connect User's Guide in your native language, please use a version in another language.

Using a Wireless Mode

Your camera has a variety of different wireless modes. Select the wireless mode that suits your specific requirements.

1. Press [] (Wireless).

This displays a wireless mode screen.

[] (Wireless)

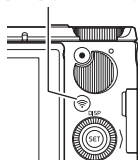

2. Use [, [, [, and [] to select the wireless mode you want, and then press [SET].

- To exit the wireless mode, press [] (Wireless).

Send to phone

Select to view images you shoot with the camera on a smartphone (page 170).

Pairing

Select this mode to establish a Bluetooth wireless technology connection between the camera and a smartphone (page 163).

Shoot with phone







Select this mode for remote control of image recording from a smartphone (page 166).

Wireless settings

Select this mode to configure wireless settings (page 172).

■ Wireless Connection Icons

After you configure camera and smartphone connection settings, the icons below will appear on the camera screen to indicate the current communication status.

	Semi-transparent	Pairing is complete, but there is no Bluetooth wireless technology connection.
	Opaque	Pairing is complete, and there is a Bluetooth wireless technology connection.
	Semi-transparent	Wireless LAN is enabled, but there is no connection.
	Opaque	Wireless LAN connected.
	Opaque	Wireless LAN connected, and image data is being sent.
	Opaque	Camera is in the Airplane Mode.
	Opaque	"Location info" is enabled.

Getting Ready to Establish a Connection between a Smartphone and Your Camera

Installing the EXILIM Connect Smartphone app on your smartphone makes it possible to remotely control the camera from your smartphone and to send images recorded with the camera to your smartphone. Search the EXILIM Connect app on Google Play™ or App Store and install it on your smartphone.

For information about OS versions (Android and iOS) supported by the EXILIM Connect app, visit the Google Play or the App Store download site, or the Official CASIO Digital Camera Website (<http://www.exilim.com/>).

■ App operation guarantees

No guarantees are made concerning the ability to operate the EXILIM Connect app on any particular smartphone or tablet.



IMPORTANT!

- App functions and the required operating environment are subject to change without notice.

Installing the EXILIM Connect App on Your Smartphone

■ Android terminal

1. Open “Play Store” (Google Play).

2. In the search field, type “EXILIM Connect”.

3. Install “EXILIM Connect”.

■ iPhone (iOS)

1. Open “App Store”.

2. In the search field, type “EXILIM Connect”.

3. Install “EXILIM Connect”.

Establishing a Wireless Connection for the First Time

The first time you establish a wireless connection between the camera and a smartphone, you need to use the procedure below to configure wireless connection settings. This operation is required for the first connection only.

■ Smartphone that supports Bluetooth low energy technology

Connecting the camera to a smartphone using Bluetooth wireless technology (pairing) makes it simple to configure wireless connection settings.

IMPORTANT!

- Performing this operation automatically configures your smartphone's wireless LAN connection settings (page 165).
- Your camera can be paired with a single smartphone at one time.
- Some smartphone models may not be compatible with this camera.
- If you want to re-pair the camera with the smartphone it is already paired with, first unpair them and then pair again. Re-pairing the camera and smartphone will result in all pending unsent images to remain unsent.

Camera Operation

1. Press [] (Wireless).

This will display the wireless mode screen.

2. Use [, [, [, and [] to select "Pairing" and then press [SET].

3. Select "Start" and then press [SET].

Smartphone Operation

4. Start up the "EXILIM Connect" app.

5. Tap "Pairing".

6. On the smartphone, tap the camera's name you want to pair with.

This completes pairing of the camera and smartphone, and establishes a Bluetooth wireless technology connection.

- In the case of an Android terminal, wireless LAN connection settings are also configured automatically. In this case, advance to step 10 of this procedure. If the screen shown in step 10 is not displayed, use the smartphone's Wi-Fi settings to select the SSID displayed on the camera and establish a wireless LAN connection between the camera and smartphone.
- In the case of an iPhone (iOS), you need to configure wireless LAN settings (install a profile) next. Advance to step 7 of this procedure.

7. On the smartphone, tap “Install”.

Follow the instructions that appear on the smartphone to install the profile required for wireless LAN setup.

- On some smartphone models, the passcode input screen may appear. If this happens, input your smartphone’s passcode.

8. After installation of the profile is complete, tap “Done” on the smartphone.

9. On the smartphone screen, tap “Back to App”.

This establishes a wireless LAN connection between the camera and smartphone.

- If you are using an iPhone (iOS) and there is no wireless LAN connection between the camera and smartphone, use the smartphone’s Wi-Fi settings to select the camera’s SSID to establish a wireless LAN connection between the camera and smartphone.

10. On the smartphone, tap “OK”.

11. Follow the instructions that appear on the smartphone to complete the pairing operation.

Camera Operation

12. Press [SET].**NOTE**

- After the camera is paired, Bluetooth wireless technology operation will consume battery power even when the camera is turned off. Because of this, it is recommended that you charge the camera’s battery before you plan to use it.
- Removing the camera’s battery will terminate the Bluetooth wireless technology connection. However, the connection will be re-established when you load a battery into the camera and turn on the power again.

■ Smartphone that does not support Bluetooth low energy technology

Configure smartphone wireless LAN connection settings (input the camera SSID and password).

1. Press [📶] (Wireless).

2. Use [▲], [▼], [◀], or [▶] to select “Shoot with phone”, and then press [SET].

3. Use [▲] and [▼] to select “Remote Start”, and then press [SET].

This will enable connection with a smartphone and the camera will display a screen for input of an SSID and password.



4. For the smartphone's Wi-Fi settings, enter the camera's SSID and password to establish a wireless LAN connection between the camera and smartphone.

When the smartphone establishes a wireless LAN connection with the camera, the message “Start up the phone app.” appears on the camera's monitor screen.

- What you need to do to establish a wireless LAN connection depends on the type of smartphone you are using. For details about how to establish a wireless LAN connection see the user documentation that comes with your smartphone.
- The camera SSID (which cannot be changed) is shown below.
SSID: ZR5100-XXXXXX (6-character alphanumeric ID)
- Under initial settings, you can check the camera's password by going to the wireless mode screen and then selecting the following: “Wireless settings” → “WLAN password” (page 177).

5. On the smartphone, start up “EXILIM Connect”.

■ What to do if you are unable to establish a wireless LAN connection between the camera and a smartphone.

This problem may be caused when the smartphone is already wirelessly connected to one of the networks or devices below. Go to your smartphone's Wi-Fi settings and select this camera's SSID.

- Household wireless LAN
- Public wireless LAN
- Portable wireless LAN device

Using a Smartphone as a Camera Remote Controller (Shoot with phone)

This function lets you remotely shoot a snapshot or movie with the camera using a smartphone. You also can perform remote zoom, self-timer, and other operations as well.

NOTE

- When using a smartphone to shoot with the camera, you can add location information obtained by the smartphone to the image data. For information about how to do this, refer to the EXILIM Connect User's Guide (page 159).

■ Bluetooth Wireless Technology Connection

1. Perform one of the operations below.

- Turn off the camera.
- Display the wireless mode screen.

2. On the smartphone, start up the “EXILIM Connect” app.

3. On the smartphone, tap “Remote Capture”.

4. Compose the image on the smartphone's screen as you shoot.

For information about how to use “Shoot with phone”, refer to the EXILIM Connect manual (page 159).

■ Cannot connect Bluetooth Wireless Technology

1. Press [] (Wireless).

2. Use [, [, [, and [] to select “Shoot with phone”, and then press [SET].

3. Use [] and [] to select “Remote Start”, and then press [SET].

- If there is a wireless LAN connection between the smartphone and camera, advance to step 5 of this procedure.

4. For the smartphone's Wi-Fi settings, select the SSID displayed on the camera and establish a wireless LAN connection between the camera and smartphone.

5. On the smartphone, start up the “EXILIM Connect” app.

6. Compose the image on the smartphone's screen as you shoot.

For information about how to use “Shoot with phone”, refer to the EXILIM Connect manual (page 159).

Sharing Snapshots with an Unpaired Smartphone (One Time Share)

Share selected snapshots for viewing on smartphones that are not paired with the camera. With One Time Share, you can send selected snapshots to a smartphone that is Bluetooth paired, which then uploads them to a “Scene Server.” To upload snapshots to the Scene sever, you need to have the Scene app installed on the smartphone that is paired with the camera.

- Your smartphone must have Internet access to use this function. If your camera is paired with an iPhone (iOS), you also need to use the iPhone to access the EXILIM Connect settings screen and link with the Scene app before using this function. For information about how to configure settings, refer to the EXILIM Connect User’s Guide (page 159).

1. Press [📶] (Wireless).

2. Use [▲], [▼], [◀], and [▶] to select “Send to phone” and then press [SET].

3. Use [▲] and [▼] to select “One Time Share” and then press [SET].

4. Use [▲], [▼], [◀], and [▶] to move the red boundary to a snapshot you want to share and then press [SET].

Selecting an image causes a check mark to appear in its check box.

- You can zoom a snapshot by sliding the zoom slider towards [⏏] (Q).
- To exit the image sharing operation, press [▶] (PLAY).

5. After selecting all of the snapshots you want to share, press [MENU].

This will cause the images you selected to be sent to the smartphone, which will then upload them to the Scene Server.

- A QR code will appear on the camera monitor screen when image send to the smartphone starts.
- If a send operation is taking a long time, the QR code screen will change to a send in progress message. To stop the send operation while this message is displayed, press [MENU].
- An error message will appear on the camera’s monitor screen if a send operation is not successful for some reason.
- A confirmation message will appear on the monitor screen if you try to turn off the camera while the QR code screen is displayed. Do not turn off power until the send operation is complete.



6. Using the smartphone with which the snapshots are to be shared, read the QR code from the camera's monitor screen.

- Your smartphone must have a QR code reader function in order to read the QR code.

7. Use smartphone to access the URL produced by reading the QR code.

This will display the snapshots that were uploaded when the QR code was created.





NOTE



- You can select up to 100 files, totaling no more than 500MB, for a single share operation.
- When a large number of images are selected, it will take some time to send them to the smartphone and/or upload them to the Scene server.
- To discontinue sharing of a set of images, use the Scene app to configure the settings required to stop sharing.
- One Time Share cannot be used if there is insufficient free space on the memory card.







Sending a Snapshot or Movie File from Camera Memory to a Smartphone (Send Selected Image)

You can select one more snapshot and/or movie file in camera memory and send it to a smartphone. You can select up to 100 snapshot and movies, totaling no more than 500MB, for a single send operation. After sending an image to a smartphone, you can then upload it to a social networking service.

1. Press [] (Wireless).

2. Use [, [, [, and [] to select “Send to phone”, and then press [SET].

3. Use [, and [] to select “Send Selected Image”, and then press [SET].

4. Use [, [, [, or [] to move the red boundary to the image you want to send to the smartphone, and then press [SET].
Selecting the image of a file causes its check box to become selected.
 - You can enlarge the selected image by rotating the zoom controller towards [] ().
 - To exit the send image to smartphone operation, press [] (PLAY).

5. After selecting the images of all of the files you want to send to the smartphone, press [MENU].

For information about how to use “Send Selected Image”, refer to the EXILIM Connect manual (page 159).

- Except for protected images, images that are sent will be marked by a “” (image sent) icon (page 15). The image sent icon may not appear when an image that was shot using another camera is sent.

Viewing Snapshots and Movies in Camera Memory on a Smartphone (View on phone)

You can connect the camera to a smartphone over wireless LAN to view and download snapshots and movies in camera memory on up to eight connected smartphones. You can also view snapshots and movies in camera memory on a computer, and copy them to a computer. A smartphone does not need to have the EXILIM Connect app installed in order to access camera images using this function.

1. Press [] (Wireless).

2. Use [▲], [▼], [◀], and [▶] to select “Send to phone”, and then press [SET].

3. Use [▲] and [▼] to select “View on phone”, and then press [SET].

This establishes a connection between the smartphone and camera, and displays a URL.

- If the message “Connect your phone to the access point below.” remains on the camera’s monitor screen, change the smartphone’s Wi-Fi settings so your camera is selected for connection (page 163).
- After about 60 seconds, the camera’s monitor screen will go blank. Pressing [SET] will cause its image to reappear.

4. On the smartphone, start up its browser app.

- Accessing the URL displayed by the camera will display an image stored in camera memory.
- To exit the wireless LAN function, press [MENU].



URL

IMPORTANT!

- Some smartphone models may not be able to play back movie files.

NOTE

- You can also view image in camera memory on a computer's browser by establishing a wireless LAN connection with the computer.
- For information about how to start up EXILIM Connect and view images, refer to the EXILIM Connect manual (page 159). Note that the operation you need to perform depends on whether or not there is a Bluetooth wireless technology connection with the smartphone.

Sending Images Shot with the Camera to a Phone that is not Paired with It (Send Image)

You can send snapshots and movies recorded with the camera to a phone that is not paired with it. You can send up to one snapshot and movie file (all the files in one group in the case of CS group), totaling no more than 500MB for a single send operation.

1. Turn on the camera and press [▶] (PLAY) to enter the PLAY mode.

2. Use [▲], [▼], [◀], and [▶] to select the image you want to send and then press [SET].

This displays the message "Sends this image to a phone."

3. Select "Send", and then press [SET].

This will enable connection with a smartphone and the camera will display a screen for input of an SSID and password.

4. For the smartphone's Wi-Fi settings, enter the camera's SSID and password to establish a wireless LAN connection between the camera and smartphone.

5. On the smartphone, start up "EXILIM Connect".

This will establish a wireless LAN connection between the smartphone and camera, and send the selected images to the smartphone.

NOTE

- Except for protected images, images that are sent will be marked by a "📷" (image sent) icon (page 15). The image sent icon may not appear when an image that was shot using another camera is sent.
- You can specify the size of the image sent to the smartphone using "Resize before send" (page 175).
- You can use the smartphone apps below to view snapshots after sending them.
 - iPhone: Camera Roll
 - Android terminal: Gallery, Photo, or another photo browser app

Configuring Wireless Connection Settings

This section explains wireless mode operations and setting items.

1. Press [📶] (Wireless).

This will display the wireless mode screen.

- Pressing [📶] (Wireless) again will return to the screen that was displayed before the wireless mode screen.

2. Use [▲], [▼], [◀], and [▶] “Wireless settings” and then press [SET].

This will display the wireless setting screen.

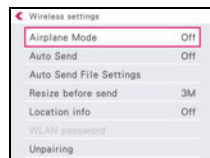

3. Use [▲] and [▼] to select the item you want to configure and then press [SET].

4. Change the setting of the selected item.

5. When the settings are the way you want, press [SET].

- Pressing [MENU] cancels the currently displayed settings and returns to the wireless mode screen.

Entering the Camera's Airplane Mode (Airplane Mode)



Item name: Airplane Mode

Wireless connection with the camera is disabled while “On” is selected for the airplane mode setting. Enter the airplane mode to disable generation of radio waves from the camera while in a medical facility, on an aircraft, etc.

Sending Images from the Camera to a Smartphone as They are Recorded (Auto Send)

Item name: Auto Send

Camera settings can be configured to send images automatically over a wireless connection to a smartphone after they are recorded.

Setting	Description
On	Automatically sends images to the smartphone after they are shot.
Off	Auto Send disabled. Sends image files selected by you to the smartphone. <ul style="list-style-type: none">• While this setting is selected,  will be displayed on the monitor screen along with the image you recorded. Pressing the camera's [SET] button will cause the displayed image to be sent to the smartphone.• To send an image file that was displayed by pressing [SET] after the  icon was displayed, perform steps 4 and 5 under "Sending Images Shot with the Camera to a Phone that is not Paired with It (Send Image)" (page 171).

1. Display "Wireless settings".

2. Use [▲] and [▼] to select "Auto Send" and then press [SET].

3. Use [▲] and [▼] to select the "Auto Send" setting you want and then press [SET].



- Images that are sent will be marked by a  (image sent) icon (page 15).



IMPORTANT!

- Auto Send cannot be enabled unless the camera is paired with a smartphone (page 163).

NOTE





- Auto Send can be used only with a smartphone that supports Bluetooth low energy technology. Both a Bluetooth and wireless LAN connection are required between the camera and smartphone to auto send camera images.
- The icons below are displayed on the camera screen while the camera and smartphone are connected.
 - Wireless LAN connection: 
 - Bluetooth wireless technology connection: 
- You can specify the size of the image sent to the smartphone using “Resize before send” (page 175).
- The image data below is not sent automatically to the smartphone.
 - CS images
 - Interval Snapshot images
- Performing an Auto Send operation of a cutout image recorded with Wide View Photo also sends its wide view photo movie.
- You can use the smartphone apps below to view snapshots after sending them.
 - iPhone: Camera Roll
 - Android terminal: Gallery, Photo, or another photo browser app
- Auto Send is disabled while the camera’s Airplane Mode setting is “On” (page 172). Auto Send become re-enabled when the camera’s Airplane Mode setting is changed to “Off”.
- Even you change the Auto Sent setting to “Off” while “On” image send operation is in progress, all of the images will be sent to the smartphone.
- When “On” is selected for Auto Send, a message will appear whenever you try to delete a file or turn off the camera.
- If you try to turn off the camera while there are unsent images in memory, a message will appear to alert you. If you want the images to be sent, leave the camera on until the send operation is complete. Pressing [ON/OFF] (Power) again will turn off the camera.
- Note that if the connection between the camera and smartphone is lost while there are unsent images in memory, the camera will turn off after about one minute. In this case, the camera will try to send the images again after it is turned back on.

Specifying Images to be Sent by Auto Send (Auto Send File Settings)

Item name: Auto Send File Settings

Specifies the files to be sent to a smartphone by Auto Send.

You can use the setting below to specify one of five file types to be sent while “On” is selected for Auto Send.

Setting	Description
	Sends snapshots, Wide View Photos, and movies.
	Sends snapshots and Wide View Photos.
 Selfie	Sends face detection images shot with a flipped screen. Turn on face detection before shooting.*1 *2
 Portrait	Sends face detection images. Turn on face detection before shooting.*1 *2
 Non-portrait	Sends non-face detection images. Turn on face detection before shooting.*1 *2

*1 Confirm that face detection (page 118) is enabled (On) before using these functions. These functions will not work if face detection is disabled (Off). Note that some recording modes automatically disable face detection.

*2 In the case of an image shot with Wide View Photo, judgment of whether or not faces are present is based on the original image only. If the original image includes faces while the cutout image does not, the cutout image will be judged to include a face.

IMPORTANT!

- The maximum size movie file that can be sent by Auto Send is 100 MB.

Resizing Snapshots before Sending Them to a Smartphone (Resize before send)

Item name: Resize before send

Use this feature to resize just shot snapshots before they are sent to a smartphone using “Auto Send” or “Shoot with phone”, or when sending images with “Send to phone”.

3M	Images are converted to 3M size before being sent. <ul style="list-style-type: none">• If an original image is 3M size or smaller, it is sent without resizing.
Off	Images are sent in the size they were originally recorded.

Add Location Info to Snapshots (Location info)

Item name: Location info

You can enable the setting below to have the smartphone acquire and record location information (latitude and longitude) when you shoot a snapshot with the camera. Then when you send the snapshot to the smartphone, the location information will be added to it. Note that location information is not added to movies or to images shot with Interval Snapshot.

Setting	Description
On	Smartphone acquires and records location information when a snapshot is shot, and adds it to the image data when the snapshot is sent to the camera.
Off	Location information is not acquired or added.



IMPORTANT!

- Location information can be recorded only while there is a Bluetooth wireless technology connection between the camera and smartphone.
- To select “On” for the camera’s “Location info” setting, pair the camera with a smartphone (page 163).
- While “On” is selected for “Location info”, the smartphone acquires and records location information each time you shoot a snapshot with the camera.
- Location information is not added to snapshot data stored in camera memory. It is added when the snapshot is sent to the smartphone.
- To use this function, your smartphone’s location services must be enabled, and it must be where location information can be received. Location information will not be available to add to images if the smartphone is unable to receive location information.
- You can check whether or not location information was added successfully on the smartphone’s image receive screen.
- Up to 10,000 location records can be maintained by the smartphone. If there are already 10,000 records, shooting a new snapshot will cause the oldest location record to be deleted to make room for the new one.
- Enabling location-based services causes the location information, and other personally identifiable information to be included in the snapshot data. Take care when sharing or publishing such images on web services, etc.
- This camera is not designed to be used for navigation, surveying, or other activities that require precision instruments.

Changing the Camera Password for Wireless LAN Connection (WLAN password)

Item name: WLAN password

Use procedure to change the password you used when establishing a wireless LAN connection between the camera and a smartphone.

IMPORTANT!

- Before changing the wireless LAN password, unpair the camera from its paired smartphone (page 178).

1. Use [◀] and [▶] to move the cursor to the password digit you want to change.

2. Use [▲] and [▼] to change the currently selected digit.

3. When the password is the way you want, move the cursor to “Apply” and then press [SET].

NOTE

- Changing the wireless LAN password will terminate the connection with the smartphone. To reconnect with the smartphone, configure wireless connection settings (page 163). If your smartphone does not support Bluetooth low energy technology, perform the operations below to change your smartphone's Wi-Fi settings.
 - iPhone:
Tap the right arrow of the field where the SSID of the camera is displayed in the Wi-Fi settings to delete network settings. After deleting, select the camera SSID again and input the new password.
 - Android terminal:
Tap the field where the SSID of the camera is displayed in the Wi-Fi settings and select Forget. Select the camera SSID again and input the new password.

Unpairing the Camera from a Smartphone (Unpairing)

Item name: Unpairing

Unpairs the camera from a smartphone.

To use the camera with a different smartphone, first unpair it from the current smartphone.

NOTE

- When unpairing, be sure also to perform the unpairing operation on the smartphone as well. For details, refer to the EXILIM Connect User's Guide (page 159).
- Unpairing the camera from a smartphone will result in all pending unsent images to remain unsent.

Printing

Printing Snapshots

Professional Print Service*

You can take a memory card that contains the images you want to print to a professional print service and have them printed.



Printing on a Home Printer*

You can use a printer equipped with a memory card slot to print images directly from a memory card. For details, see the user documentation that comes with your printer.



Printing with a Computer

After transferring the images to your computer, use commercially available software to print.

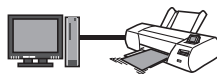

* You can specify which images you want to print, the number of copies, and date stamp settings before printing (page 179).

Using DPOF to Specify Images to be Printed and the Number of Copies (DPOF Printing)

■ Digital Print Order Format (DPOF)

DPOF is a standard that allows you to include image type, number of copy, and time stamp on/off information on the memory card with the images. After configuring settings, you can use the memory card to print on a home printer that supports DPOF or take the memory card to a professional print service.



- Whether or not you will be able to use DPOF settings for printing depends on the printer you are using.
- Some professional print services may not support DPOF.

■ Configuring DPOF Settings Individually for Each Image

1. In the PLAY mode, press [MENU].

2. Press [◀], use [▲] and [▼] to select the “▶ PLAY MENU” tab, and then press [▶].

3. Use [▲] and [▼] to select “DPOF Printing”, and then press [▶].

4. Use [▲] and [▼] to select “Select images”, and then press [SET].

5. Use [◀] and [▶] to scroll through the files until the image you want to print is displayed.

6. Use [▲] and [▼] to specify the number of copies.
You can specify a value up to 99. Specify 00 if you do not want to print the image.
 - If you want to include the date in the images, press [●] (Movie) so “On” is shown for date stamping.
 - Repeat steps 1 and 2 to configure settings for other images, if you want.

7. Press [SET].

■ Configuring the Same DPOF Settings for All the Images

1. In the PLAY mode, press [MENU].

2. Press [◀], use [▲] and [▼] to select the “▶ PLAY MENU” tab, and then press [▶].

3. Use [▲] and [▼] to select “DPOF Printing”, and then press [▶].

4. Use [▲] and [▼] to select “All images”, and then press [SET].

5. Use [▲] and [▼] to specify the number of copies.
You can specify a value up to 99. Specify 00 if you do not want to print the image.
 - When printing a CS or interval shot group, the specified number of copies of all of the images in the group is printed.
 - If you want to include the date in the images, press [●] (Movie) so “On” is shown for date stamping.

6. Press [SET].

■ Specifying the Number of Images for Grouped Images

You can specify the number of copies when printing images that are part of a CS or interval group.

1. While playback of a CS or interval group is in progress or paused, press [▼].

- This will display the “Edit Group” menu.

2. Use [▲] and [▼] to select “DPOF Printing” and then press [SET].

3. Use [▲] and [▼] to select print method you want to use and then press [SET].

Select Frames	Specifies which group's images and how many copies of each should be printed. ① Use [◀] and [▶] to scroll through images until one you want to print is displayed. ② Use [▲] and [▼] to specify the number of copies. You can specify a value up to 99. Specify 00 for images you do not want to print. <ul style="list-style-type: none">• If you want to include the date in the images, press [●] (Movie) so “On” is shown for date stamping.• Repeat steps ① and ② for all of the images you want to print. ③ Press [SET].
Frame all	Specifies the same print settings for all the images in a group. ① Use [▲] and [▼] to specify the number of copies. You can specify a value up to 99. Specify 00 if you do not want to print the group images. <ul style="list-style-type: none">• If you want to include the date in the images, press [●] (Movie) so “On” is shown for date stamping. ② Press [SET].

DPOF settings are not cleared automatically after printing is complete.

The next DPOF print operation you execute will be performed using the last DPOF settings you configured for the images. To clear DPOF settings, specify "00" for the number of copies of all images.

Tell your print service about your DPOF settings!

If you take a memory card to a professional print service, be sure to tell them that it includes DPOF settings for the images to be printed and the number of copies. If you don't, the print service may print all the images without regard to your DPOF settings, or they may ignore your date stamp setting.

■ Date Stamping



You can use one of the following three methods to include the recording date in the printout of an image.

Configuring camera settings
Configure DPOF settings (page 179). You can turn date stamping on and off each time you print. You can configure settings so some images include the date stamp and some don't.
Configure the Camera's Timestamp setting (page 195). <ul style="list-style-type: none">• The camera's Timestamp setting imprints the date into a snapshot when you shoot it, so the date is always included when you print. It cannot be deleted.• Do not turn on DPOF date stamping for an image that includes a date stamped with the camera's Timestamp function. Doing so can cause the two stamps to be overprinted.
Configuring computer settings
You can use commercially available image management software to date stamp images.
Professional print service
Request date stamping when ordering prints from a professional print service.

Using the Camera with a Computer

Things you can do using a computer...

You can perform the operations described below while the camera is connected to a computer.

<p>Save images to a computer and view them there</p> 	<ul style="list-style-type: none">• Save images and view them manually (USB connection) (pages 184, 187).
<p>Play back and edit movies</p> 	<ul style="list-style-type: none">• You can play back movies (pages 186, 189). To play back movies, use software that is compatible with your computer's operating environment.• To edit movies, use commercially available software as required.

The procedures you need to perform are different for Windows and the Macintosh.

- Windows users should refer to "Using the Camera with a Windows Computer" on page 184.
- Macintosh users should refer to "Using the Camera with a Macintosh" on page 187.

Using the Camera with a Windows Computer

When you want to do this:	Operating System Version	Required Software
Save images to a computer and view them there manually	Windows 10, Windows 8.1, Windows 7	Installation not required.
Play movies	Windows 10, Windows 8.1, Windows 7	Windows Media Player 12

- The above recommended computer system environments do not guarantee proper operation.
- The type of computer being used, certain settings, and other installed software may interfere with proper operation.

Viewing and Storing Images on a Computer

You can connect the camera to your computer in order to view and store images (snapshot and movie files).

Never use your computer to modify, delete, move, or rename any image files that are in the camera's built-in memory or on its memory card.

Doing so can cause problems with the camera's image management data, which will make it impossible to play back images on the camera and can drastically alter remaining memory capacity. Whenever you want to modify, delete, move, or rename an image, do so only on images that are stored on your computer.



IMPORTANT!

- Never unplug the USB cable, or operate the camera while viewing or storing images. Doing so can cause data to become corrupted.

NOTE

- You also can use your computer's card slot (if it has one) or a commercially available card reader to access image files directly from the camera's memory card. For details, see the user documentation that comes with your computer.

■ To connect the camera to your computer and save files

1. Turn off the camera and then use the micro USB cable that comes with the camera to connect it to your computer.

- For details about connecting to the camera and precautions when connecting, see page 24.

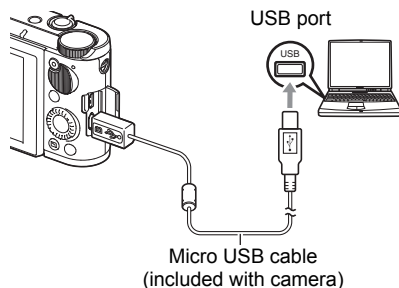

2. Press [ON/OFF] (Power) to turn on the camera.

When you turn on the camera, check to make sure that the color of its back lamp changes from red to green or amber (page 24). Note that in this case the camera's lens will not extend and the monitor screen will remain blank.

- The first time you connect the camera to your computer with the USB cable, an error message may appear on your computer. If this happens, disconnect and then reconnect the USB cable.

3. Windows 10 users: Click "Start" and then "Explorer". Next, in the sidebar, click "PC".

Windows 8.1 users: Click "Desktop" and then "Explorer".

Windows 7 users: Click "Start" and then "Computer".

4. Double-click "Removable Disk".

- Your computer recognizes the memory card loaded in the camera (or built-in memory if there is no card) as a removable disk.

5. Right-click the "DCIM" folder.

6. On the shortcut menu that appears, click "Copy".

7. Windows 10, Windows 8.1 users: Click "Documents".

Windows 7 users: Click "Start" and then "Documents".

- If you already have a "DCIM" folder in "Documents", the next step will overwrite it. If you want to keep the existing "DCIM" folder, you need to change its name or move it to a different location before performing the next step.

8. Windows 10, Windows 8.1 users: On the “Documents” menus, click “Home” and then “Paste”.

Windows 7 users: On the “Documents” menu, click “Organize” or “Edit”, and then “Paste”.

This will paste the “DCIM” folder (and all the image files it contains) into your “Documents” folder. You now have a copy of the files that are in camera memory on your computer.

- After copying images, it is recommended that you right-click the DCIM folder and change its name to something else.

9. After you finish copying images, disconnect the camera from the computer.

After confirming that the back lamp is not flashing red, disconnect the USB cable.

■ To view images you copied to your computer

1. Double-click the copied “DCIM” folder to open it.

2. Double-click the folder that contains the images you want to view.

3. Double-click the image file you want to view.

- For information about file names, see “Memory Folder Structure” on page 191.
- An image that was rotated on the camera will be displayed on your computer screen in its original (unrotated) orientation.
- Viewing CS and interval shot images on a computer will individually display the component images in the group. CS and interval shot images cannot be viewed as a group on a computer.

■ Movie Playback Precautions

- To play back a movie, first save it to your computer and then double-click the movie file. Proper movie playback may not be possible for data accessed over a network, from a memory card, etc.
- Proper movie playback may not be possible on some computers. If you experience problems, try the following.
 - Try recording movies with a quality setting of “STD”.
 - Quit any other applications you have running, and stop resident applications.

Even if proper playback is not possible on the computer, you can use a commercially available HDMI cable to connect to the HDMI terminal of a TV and play back movies that way.

Using the Camera with a Macintosh

When you want to do this:	Operating System Version	Required Software
Save images to your Macintosh and view them there manually	OS X 10.5 or higher	Installation not required.
Play movies		QuickTime Player

- The above recommended computer system environments do not guarantee proper operation.
- Proper operation depends on the level of performance of the computer you are using.

Connecting the Camera to Your Computer and Saving Files

Never use your computer to modify, delete, move, or rename any image files that are in the camera's built-in memory or on its memory card.

Doing so can cause problems with the camera's image management data, which will make it impossible to play back images on the camera and can drastically alter remaining memory capacity. Whenever you want to modify, delete, move, or rename an image, do so only on images that are stored on your computer.

IMPORTANT!

- Never unplug the USB cable, or operate the camera while viewing or storing images. Doing so can cause data to become corrupted.

NOTE

- You also can use your computer's card slot (if it has one) or a commercially available card reader to access image files directly from the camera's memory card. For details, see the user documentation that comes with your computer.

■ To connect the camera to your computer and save files

1. Turn off the camera and then use the micro USB cable that comes with the camera to connect it to your Macintosh (page 185).

2. Press [ON/OFF] (Power) to turn on the camera.

When you turn on the camera, check to make sure that the color of its back lamp changes from red to green or amber (page 24). Note that in this case the camera's lens will not extend and the monitor screen will remain blank.

In this mode, your Macintosh recognizes the memory card loaded in the camera (or the camera's built-in memory if it does not have a memory card loaded) as a drive. The appearance of the drive icon depends on the Mac OS version you are using.

- The first time you connect the camera to your Macintosh with the USB cable, an error message may appear on your computer. If this happens, disconnect and then reconnect the USB cable.
-

3. Double-click the camera's drive icon.

4. Drag the "DCIM" folder to the folder to which you want to copy it.

5. After the copy operation is complete, drag the drive icon to Trash.

6. Disconnect the camera from the computer.

After confirming that the back lamp is not flashing red, disconnect the USB cable.

■ To view copied images

1. Double-click the camera's drive icon.

2. Double-click the "DCIM" folder to open it.

3. Double-click the folder that contains the images you want to view.

4. Double-click the image file you want to view.

- For information about file names, see "Memory Folder Structure" on page 191.
- An image that was rotated on the camera will be displayed on your Macintosh screen in its original (unrotated) orientation.
- Viewing CS and interval shot images on a computer will individually display the component images in the group. CS and interval shot images cannot be viewed as a group on a computer.

■ **Movie Playback Precautions**

- To play back a movie, first save it to your computer and then double-click the movie file. Proper movie playback may not be possible for data accessed over a network, from a memory card, etc.
- Proper movie playback may not be possible on some Macintosh models. If you experience problems, try the following.
 - Try recording movies with a quality setting of “STD”.
 - Shut down other applications that are running.

Even if proper playback is not possible on your Macintosh, you can use a commercially available HDMI cable to connect to the HDMI terminal of a TV and play back movies that way.

Files and Folders

The camera creates a file each time you shoot a snapshot, record a movie, or perform any other operation that stores data. Files are grouped by storing them in folders. Each file and folder has its own unique name.

- For details about how folders are organized in memory, see “Memory Folder Structure” (page 191).

Name and Maximum Number Allowed	Example
File	
Each folder can contain up to 9999 files named CIMG0001 through CIMG9999. The extension on the file name depends on the file type.	26th file name: CIMG0026.JPG Serial number Extension (4 digits)
Folders	
Folders are named from 100CASIO to 999CASIO. There can be up to 900 folders in memory.	First folder name: 100CASIO Serial number (3 digits)

- When viewing snapshots or playing back movies, the folder name and file name in the upper right corner of the monitor screen has the meaning described below. Example: 100-0023: 23rd file in the folder named “100CASIO”.
- You can view folder and file names on your computer. For details about how file names are displayed on the camera’s monitor screen, see page 15.
- The total number of folders and files allowed depends on the image size and quality, and capacity of the memory card being used for storage.

Memory Card Data

The camera stores images you shoot in accordance with the Design Rule for Camera File System (DCF).

■ About DCF

The following operations are supported for DCF-compliant images. Note, however, that CASIO makes no performance guarantees concerning these operations.

- Transferring this camera's DCF-compliant images to another manufacturer's camera and view them.
- Printing this camera's DCF-compliant images on another manufacturer's printer.
- Transferring another camera's DCF-compliant images to this camera and view them.

■ Memory Folder Structure

Memory

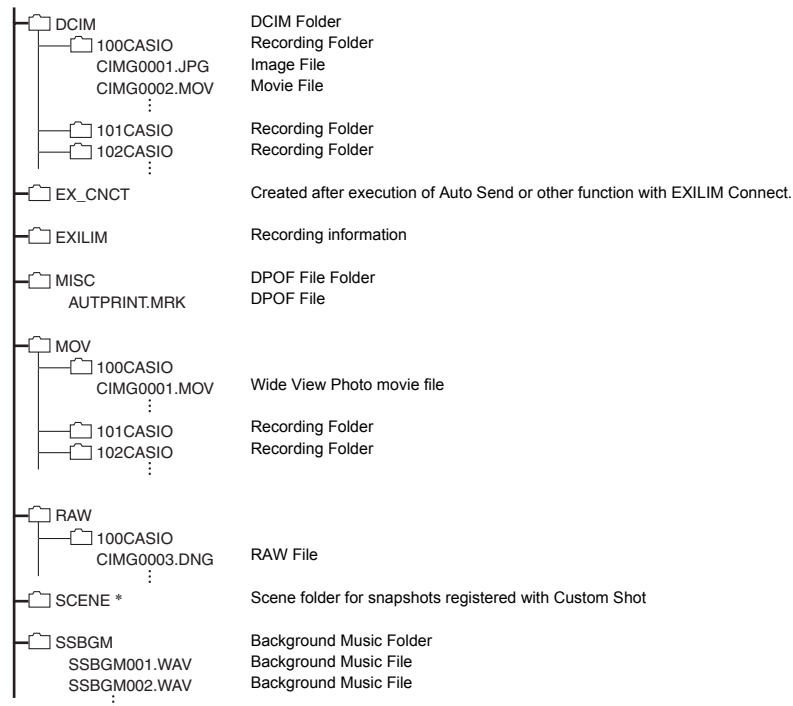

* This folder or file can be created in built-in memory only.

■ Supported Image Files

- Image files shot with this camera
- DCF-compliant image files

This camera may not be able to display an image, even if it is DCF-compliant. When displaying an image recorded on another camera, it may take a long time for the image to appear on this camera's monitor screen.

■ Built-in Memory and Memory Card Data Handling Precautions

- Whenever copying memory contents to your computer, you should copy the DCIM folder and all of its contents. A good way to keep track of multiple DCIM folders is to change their names to dates or something similar after you copy them to your computer. If you later decided to return a DCIM folder to the camera, however, be sure to change its name back to DCIM. The camera is designed to recognize only a root file with the name DCIM. Note the camera also will not be able to recognize the folders inside the DCIM folder unless they have the names they originally had when you copied them from the camera to your computer.
- Folders and files must be stored in accordance with the "Memory Folder Structure" shown on page 191 in order for the camera to be able to recognize them correctly.

Other Settings (SETTING)

Using the Menu Screen to Configure Other Settings

This section explains menu items that apply to both the REC mode and PLAY mode.

1. Press [MENU].

2. Press [◀], use [▲] and [▼] to select the “⚙️ SETTING” tab, and then press [▶] or [SET].

3. Select the item you want and then change its setting.

- For information about menu operations, see page 110.

“⚙️ SETTING” tab

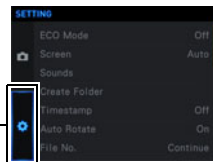

Enabling Power Saving (ECO Mode)

Menu item: **ECO Mode**

Enabling power saving reduces the brightness of the monitor screen and switches other camera operations to low-power operation, which allows a charge to last longer.

Selecting “On” enters the ECO Mode, “ECO” will appear on the screen whenever the camera is in the Program Auto mode. The power saving effect of the “ECO Mode” is most efficient when “Program Auto” is selected for the recording mode. Use the “Program Auto” recording mode is recommended when using the “ECO Mode”.

NOTE

- You can achieve even greater power savings by using the “ECO Mode” in combination with Auto Power Off (page 197) and Sleep (page 197).

Adjusting Monitor Screen Brightness (Screen)

Menu item: **Screen**

Auto	With this setting, the camera detects available light levels and automatically adjusts the brightness of the monitor screen accordingly.
+2	Brightness that is greater than +1, which makes the screen easier to view. This setting consumes more power.
+1	Bright setting for outdoor use, etc. Brightness that is greater than 0.
0	Normal monitor screen brightness for indoor use, etc.
-1	Low monitor screen brightness for nighttime use, indoor use under dark conditions, etc.

- Turning on the “ECO Mode” (page 193) while the “Screen” setting is +2 or +1 will cause the “Screen” setting to change to 0.

Configuring Camera Sound Settings (Sounds)

Menu item: **Sounds**

Startup	Specifies the startup sound Sound 1 - 5: Built-in sounds (1 through 5) Off: Sound off
Half Shutter	
Shutter	
Operation	
Operation Vol	Specifies the sound volume. This setting is also used as the audio level during TV output (page 137).
Playback Vol	Specifies the volume of movie audio output. This volume setting is not used during TV output (page 137).

- Setting a volume level of 0 mutes output.

Creating an Image Storage Folder (Create Folder)

Menu item: Create Folder

Create Folder	Creates a folder with a unique number (page 190). Files will be stored in the new folder starting from when you record your next image.
Cancel	Cancels folder creation.

- Deleting all of the files in a folder cause the folder to be deleted as well.

Time Stamping Snapshots (Timestamp)

Menu item: Timestamp

You can configure the camera to stamp the recording date only, or date and time in the lower right corner of each snapshot.

Example: July 10, 2018, 1:25 p.m.

Date	2018/7/10
Date & Time	2018/7/10 1:25pm
Off	No stamping of date and/or time

- Once date and time information is stamped into a snapshot, it cannot be edited or deleted.
- Even if you do not stamp the date and/or time with Timestamp, you can do so later using the DPOF function or some printing application (page 182).
- Stamping is performed in accordance with the date and time settings (page 200) and the display style settings (page 200).
- Time stamping is disabled when certain BEST SHOT scenes are being used.

Auto Image Orientation Detection and Rotation (Auto Rotate)

Menu item: Auto Rotate

On	Rotates the displayed image in accordance with the camera orientation when the image was recorded.
Off	Images not rotated automatically.

This setting can be used to configure the camera to display playback images in the same orientation as the camera when the image was shot.

Specifying the File Name Serial Number Generation Rule (File No.)

Menu item: File No.

Use the following procedure to specify the rule that governs generation of the serial number used in file names (page 190).

Continue	Tells the camera to remember the last used file number. A new file will be named using the next sequential number, even if files are deleted or if a blank memory card is loaded. If a memory card is loaded and that card already has files stored on it and the largest sequential number in the existing file names is greater than the largest sequential number remembered by the camera, numbering of new files will start from the largest sequential number in the memory card file names plus 1.
Reset	Restarts the serial number from 0001 whenever all files are deleted or when the memory card is replaced with a blank one. If a memory card is loaded and that card already has files stored on it, numbering of new files will start from the largest sequential number in the memory card file names plus 1.

Configuring Sleep State Settings (Sleep)

Menu item: Sleep

This feature turns off the monitor screen and lights the back lamp (green) whenever no camera operation is performed for a preset period of time. Press any button to turn the monitor screen back on.

Trigger Time Settings: 30 sec, 1 min, 2 min, Off (Sleep is disabled while "Off" is selected.)

- Sleep is disabled under any of the following conditions.
 - In the PLAY mode
 - While the camera is connected to a computer, TV, or other device
 - During movie recording and playback
 - During Shoot with smartphone operation
- When both sleep and Auto Power Off are turned on, Auto Power Off takes priority.

Configuring Auto Power Off Settings (Auto Power Off)

Menu item: Auto Power Off

Auto Power Off turns off the camera whenever no camera operation is performed for a preset amount of time.

Trigger Time Settings: 2 min, 5 min, 10 min (The trigger time is always 5 minutes in the PLAY mode.)

- Auto Power Off is disabled under any of the following conditions.
 - While the camera is connected to a computer or other device
 - During a slideshow
 - During CS or interval shot group playback
 - During Interval Shot recording
 - During Time Lapse recording
 - During movie recording and playback
 - During Shoot with smartphone operation

Specifying the Operation when the Monitor Screen is Tilted (Screen Tilt)

Menu item: Screen Tilt

Power On	Turns on the camera whenever the monitor screen is tilted.
Off	No power on operation performed when the monitor screen is tilted or returned to its normal position.

Configuring [▶] Setting (PLAY)

Menu item: PLAY

Power On	Camera turns on whenever [▶] (PLAY) is pressed.
On/Off	Camera turns on or off whenever [▶] (PLAY) is pressed.
Off	Camera does not turn on or off when [▶] (PLAY) is pressed.

- With “On/Off”, the camera turns off when you press [▶] (PLAY) in the PLAY mode.

Disabling File Deletion (Delete Key)

Menu item: Delete Key

The camera will not start the image delete operation when you press [▼] () while “Delete Key” is turned on.

You can protect against accidental deletion of images by selecting “Disabled” for “Delete Key”.

- Performing a format operation (page 201) will cause all images to be deleted, even if file deletion is disabled (“Disabled” selected for “Delete Key”) for some images.

Configuring World Time Settings (World Time)

Menu item: **World Time**

You can use the World Time screen to view the current time in a zone that is different from your Home City when you go on a trip, etc. World Time displays the current time in 162 cities in 32 time zones around the globe.

1. Use [▲] and [▼] to select “Destination” and then press [▶].

- To change the geographic area and city for the time where you normally use the camera, select “Home”.
-

2. Use [▲] and [▼] to select “City” and then press [▶].

- To change the “Destination” setting to summer time, use [▲] and [▼] to select “DST” and then select “On”. Summer time is used in some geographical areas to advance the current time setting by one hour during the summer months.
-

3. Use [▲] and [▼] to select the geographic area you want and then press [SET].

4. Use [▲] and [▼] to select the city you want and then press [SET].

5. Press [MENU] twice.

 **IMPORTANT!**

- Before configuring World Time settings, make sure that the Home City setting is the place where you live or normally use the camera. If it isn't, select “Home” on the screen in step 1 and configure the Home City, date, and time settings as required (page 200).

Setting the Camera's Clock (Adjust)

Menu item: **Adjust**

When the date and time settings are what you want, select "Apply" and then press [SET] to apply them.

[▲] [▼]	Change the setting at the cursor location
[◀] [▶]	Move the cursor between settings

- To switch between 12-hour and 24-hour timekeeping, move the cursor to "am (pm)" and "24h" (one of which will be displayed) and then use [▲] and [▼] to change the setting.
- You can specify a date from 2001 to 2049.
- Be sure to select your Home City (page 199) before setting the time and date. If you set the time and date while the wrong city is selected for your Home City, the times and dates of all of the World Time cities (page 199) will be wrong.

Specifying the Date Style (Date Style)

Menu item: **Date Style**

You can select from among three different styles for the date.

Example: July 10, 2018

YY/MM/DD	18/7/10
DD/MM/YY	10/7/18
MM/DD/YY	7/10/18

Specifying the Display Language (Language)

Menu item: **Language**

■ Specify the display language you want.

- ① Select the bottom tab "⚙️".
 - ② Select "Language".
 - ③ Select the language you want.
- Camera models sold in certain geographic areas may not support display language selection.



Selecting the HDMI Terminal Output Method (HDMI Output)

Menu item: **HDMI Output**

- See page 138 for details.

Formatting Built-in Memory or a Memory Card (Format)

Menu item: **Format**

If a memory card is loaded in the camera, this operation will format the memory card. It will format built-in memory if no memory card is loaded.

- The format operation will delete all contents on the memory card or in built-in memory. It cannot be undone. Make sure you do not need any data currently on the card or in built-in memory before you format it.
- Formatting built-in memory will delete the following data.
 - Protected images
 - "Custom Shot" setups
- Formatting a memory card will delete the following data.
 - Protected images
- Formatting will cause all images to be deleted, even if file deletion is disabled ("Disabled" selected for "Delete Key" (page 198)) for some images.
- Check the battery level before starting a format operation and make sure it is not too low. Formatting may not be performed correctly and the camera may stop operating normally if the camera powers down while formatting is in progress.
- Never open the battery cover while formatting is in progress. Doing so can cause the camera to stop operating normally.

Resetting the Camera to Factory Defaults (Reset)

Menu item: **Reset**

See page 228 for details about the camera's factory default settings.

The settings below are not reset.

World Time settings, clock settings, date style, screen language, WLAN password

NOTE

- Resetting the camera does not unpair it from a smartphone (page 163).
- Resetting the camera causes the Airplane Mode setting (page 172) to become "Off".

Checking the Current Camera Firmware Version (Version)

Menu item: **Version**

Selecting this menu item displays the camera model name, the version of firmware installed on the camera, and the camera's MAC address.

- Note that the MAC address is fixed number that functions as the camera's network device identifier.
- Check this screen after updating the camera's firmware to confirm that updating was actually performed.

Safety Precautions

DANGER

This symbol indicates information that, if ignored or applied incorrectly, creates the danger of death or serious personal injury.

WARNING

This indication stipulates matters that have the risk of causing death or serious injury if the product is operated incorrectly while ignoring this indication.

CAUTION

This indication stipulates matters that have the risk of causing injury as well as matters for which there is the likelihood of occurrence of physical damage only if the product is operated incorrectly while ignoring this indication.

Symbol Examples





This circle with a line through it (⊘) means that the indicated action must not be performed. Indications within or nearby this symbol are specifically prohibited. (The example at left indicates that disassembly is prohibited.)







The black dot (●) means that the indicated action must be performed. Indications within this symbol are actions that are specifically instructed to be performed. (The example at left indicates that the power plug must be unplugged from the electrical socket.)

DANGER

■ Rechargeable Battery

- To charge the battery, use only the method specifically described in this manual. Attempting to charge the battery by an unauthorized means creates the risk of battery overheating, fire, and explosion. 
- Do not expose or immerse the battery in fresh water or salt water. Doing so can damage the battery, and cause deterioration of its performance and loss of service life. 
- The battery is intended for use with a CASIO Digital Camera only. Use with any other device creates the risk of the battery damage, or deterioration of battery performance and service life. 

 **DANGER**

- Failure to observe any of the following precautions creates the risk of battery overheating, fire, and explosion.
 - Never use or leave the battery near open flame. 
 - Do not expose the battery to heat or fire.
 - Make sure the battery is oriented correctly when charging it.
 - Never carry or store the battery together with items that can conduct electricity (necklaces, pencil lead, etc.).
 - Never disassemble the battery, pierce it with a needle, or expose it to strong impact (hit it with a hammer, step on it, etc.), and never apply solder to it. Never place the battery into a microwave oven, dehumidifier, high-pressure generating device, etc.
 - Never remove the outer sticker from the battery.
- Should you ever notice leakage, strange odor, heat generation, discoloration, deformation, or any other abnormal condition while using, charging, or storing a battery, immediately remove it from the camera and keep it away from open flame. Also, do not use the affected battery after the abnormal symptoms disappear. 
- Do not use or leave the battery under direct sunlight, in an automobile parked in the sun, or in any other area subject to high temperatures. Doing so can damage the battery, and cause deterioration of its performance and loss of service life. Also, these conditions can cause the battery to swell to the point that you may not be able to remove it. 
- Battery fluid can damage your eyes. Should battery fluid get into your eyes accidentally, immediately rinse them with clean tap water and then consult a physician. 

 **WARNING**

■ **Smoke, abnormal odor, overheating, and other abnormalities**

- Continued use of the camera while it is emitting smoke or strange odor, or while it is overheating creates the risk of fire and electric shock. Immediately perform the following steps whenever any of the above symptoms are present. 
- 1. Turn off the camera.
- 2. If you are using the USB-AC adapter to power the camera, unplug the power plug from the power outlet. Also, remove the battery from the camera, taking care to protect yourself against burn injury.
- 3. Contact your retailer or nearest CASIO authorized service center.



■ **Keep Away From Fire**

- Never expose the camera to fire, which can cause it to explode and creates the risk of fire and personal injury. 



■ **Avoid Use While In Motion**

- Never use the camera to record or play back images while operating an automobile or other vehicle, or while walking. Looking at the monitor while in motion creates the risk of serious accident. 





■ **Flash and Other Light Emitting Functions**

- Never use light emitting functions in areas where there is the chance of flammable or explosive gas being present. Such conditions create the risk of fire and explosion. 
- Never fire the flash or use light emitting functions pointed in the direction of a person operating a motor vehicle. Doing so can interfere with the driver's vision and create the risk of accident. 



■ **USB-AC Adapter**

- Misuse of USB-AC adapter creates the risk of fire and electric shock. Be sure to observe the following precautions. 
- Use only the specified USB-AC adapter.
- Never use the USB-AC adapter with another device.
- Use a power outlet that matches the power supply specified for the USB-AC adapter.
- Never plug the USB-AC adapter or power cord into a wall outlet that is shared by other devices, or into a shared extension cord.
- Never locate the USB-AC adapter near a stove or other heating device.
- Misuse of the USB-AC adapter can cause them to become damaged, creating the risk of fire and electric shock. Be sure to observe the following precautions. 
- Never place heavy objects on the USB-AC adapter or subject it to direct heat.
- Do not modify the USB-AC adapter, allow it to become damaged, or forcibly bend it.
- Do not twist or pull on the power cord.
- When in use, locate the cord where it will not be tripped over.

 **WARNING**

- Never touch the power plug while your hands are wet. Doing so creates the risk of electric shock. 
- Should the power cord or power plug become damaged, contact your retailer or nearest CASIO authorized service center. 
- Do not use the USB-AC adapter in areas where liquids* might spill on them. Liquids create the risk of fire and electric shock. 
 - * Liquids: Water, sports drinks, seawater, animal or pet urine, etc.
- Do not place a flower vase or any other liquid container on top of the USB-AC adapter. Water creates the risk of fire and electric shock. 
- Do not touch the camera or USB-AC adapter during lightning storms. 

If a power cord was included with your camera

- The power cord that comes with the camera is designed for use in the country where the camera was purchased. If you use the camera in another country, be sure to use a power cord that conforms to that country's ratings and power supply voltage. Use of an improper power cord creates the risk of fire and electric shock. 
- Before going out, be sure to unplug the USB-AC adapter from the power outlet and put in a place away from objects used by animals and pets. An animal or pet chewing on the power cord can cause it short, leading to the risk of fire. 

■ Water and Foreign Matter

- Water, other liquids, or foreign matter (especially metal) getting inside the camera creates the risk of fire and electric shock. Immediately perform the following steps whenever any of the above symptoms are present. Particular care is required when using the camera where it is raining or snowing, near the ocean or other body of water, or in a bathroom. 
 1. Turn off the camera.
 2. If you are using the USB-AC adapter to power the camera, unplug the power plug from the wall outlet. Also, remove the battery from the camera, taking care to protect yourself against burn injury.
 3. Contact your retailer or nearest CASIO authorized service center.

■ Disassembly and Modification

- Never try to take the camera apart or modify it in any way. Doing so creates the risk of electric shock, burn injury, and other personal injury. Be sure to leave all internal inspection, maintenance, and repair up to your retailer or nearest CASIO authorized service center. 

 **WARNING**

■ **Dropping and Rough Treatment**

- Continued use of the camera after it is damaged by dropping or other rough treatment creates the risk of fire and electric shock. Immediately perform the following steps whenever any of the above symptoms are present. 
 1. Turn off the camera.
 2. If you are using the USB-AC adapter to power the camera, unplug the power plug from the wall outlet. Also, remove the battery from the camera, taking care to protect yourself against burn injury.
 3. Contact your retailer or nearest CASIO authorized service center.





■ **Memory Cards**

- Memory cards are small and present a risk of accidentally being swallowed by infants and young children. Keep memory cards out of the reach of infants and young children. If a memory card is ever swallowed accidentally, contact a physician immediately. 

■ **Precaution when Camera is On**



- Do not touch the camera for long periods while it is on. The camera becomes warm when on, and long term contact creates the risk of low-temperature burns. 

■ **Interference with other digital devices**





- Should you notice radio interference or other problems on other devices is being caused while using this camera, stop using the wireless functions of this camera, or turn off the camera. Use of wireless functions creates the risk of radio interference and abnormal operation of other devices. 
- When in a medical facility or aircraft, comply with instructions of personnel in charge. Electromagnetic waves and other signals emitted by the camera's wireless function create the risk of accident. 
- Do not use the camera's wireless function while in the vicinity of high precision digital devices or digital devices that use weak signals. Doing so can interfere with proper operation of such digital devices and create the risk of accident. 
- When using the camera's wireless function, keep it away from any person wearing a pacemaker. Magnetism emitted by the camera may affect cardiac pacemakers and other medical devices. Should you ever notice any abnormality, immediately move away from the product and contact a physician. 
- On a crowded train or any other crowded location where there is the possibility of being in the vicinity of a person wearing a cardiac pacemaker, stop using the wireless functions of this camera, or turn off the camera. Radio waves emitted by the camera's wireless function may affect pacemaker operation. 

 **CAUTION**

■ **USB-AC Adapter**

- Misuse of the USB-AC adapter creates the risk of fire and electric shock. Make sure you observe the following precautions.
 - Never cover the USB-AC adapter or power cord with a quilt, blanket, or other cover while it is in use, and do not use it near a heater. Doing so can interfere with heat radiation and cause the area around them to become hot. 
 - Do not use detergent when cleaning the power cord, the USB-AC adapter, or the USB cable (especially the plugs and jacks).
 - Insert the power plug into the wall outlet as far as it will go.
 - Unplug the power plug from the wall outlet before leaving the camera unattended for long periods, such as when leaving on a trip, etc. 
 - At least once a year, use a cloth or vacuum cleaner to clean any dust build up on the prongs of the power plug and in the area around them.
 - (Power cord included with your camera) When unplugging from the wall outlet, never pull on the power cord. Grasp the power plug and pull.

■ **Rechargeable Battery**

- If battery charging does not end normally within the specified charging time, stop charging anyway and contact your local CASIO authorized service center. Continued charging creates the risk of battery overheating, fire, and explosion. 
- Be sure to read the user documentation that comes with the camera and special charger unit before using or charging the battery. 
- Store batteries in a location that cannot be reached by infants and young children. When using a battery where infants and young children are present, be on guard to ensure that they do not have the chance to remove the battery from the charger unit or camera. 
- Do not leave batteries near areas used by pets. A pet chewing on a battery can lead to accidents caused by the battery leaking, overheating, or exploding. 
- Should fluid from a battery accidentally get onto clothing or your skin, immediately rinse it off with clean tap water. Prolonged contact with battery fluid can cause skin irritation. 

■ **Connections**

- Never plug any devices that are not specified for use with this camera into connectors. Connecting a non-specified device creates the risk of fire and electric shock. 

■ **Unstable Locations**

- Never place the camera on an unstable surface, on a high shelf, etc. Doing so can cause the camera to fall, creating the risk of personal injury. 

 **CAUTION**

■ **Locations To Be Avoided**

- Never leave the camera in any of the following types of locations. Doing so creates the risk of fire and electric shock.
 - Areas subject to large amounts of humidity or dust
 - Food preparation areas or other locations where oil smoke is present
 - Near heaters, on a heated carpet, in areas exposed to direct sunlight, in a closed vehicle parked in the sun, or other areas subject to very high temperatures



■ **Monitor Screen**

- Do not apply strong pressure to the LCD panel surface or subject it to strong impact. Doing so can cause the display panel glass to crack and lead to personal injury.
- Should the monitor screen ever become cracked, never touch any of the liquid inside the monitor screen. Doing so creates the risk of skin inflammation.
- Should monitor screen liquid ever get into your mouth, immediately rinse your mouth out and contact your physician.
- Should monitor screen liquid ever get into your eyes or onto your skin, immediately rinse with clean water for at least 15 minutes and contact your physician.



■ **Neck Strap**

- Be sure to hold the camera still with your hands while wearing it around your neck.
Never allow the camera to swing around by the neck strap.
Doing so creates the risk of personal injury caused by impact with or dropping of the camera, etc.
- Keep the neck strap out of the reach of small children.
The neck strap can become wound around the neck of a small child, creating the risk of serious accident.
- Should you notice any itching, rash, or other skin abnormality in the vicinity of the neck strap, immediately stop using it.



■ **Backing Up Important Data**

- Always keep backup copies of important data in camera memory by transferring it to a computer or other storage device. Note that data can be deleted in the case of camera malfunction, repair, etc.





■ **Memory Protection**

- Whenever replacing the battery or memory card, be sure to follow the correct procedure as described in the documentation that comes with the camera. Incorrectly replacing the battery or memory card can result in corruption or loss of data in camera memory.



 **CAUTION**

■ **Flash and Other Light Emitting Functions**

- Never fire the flash or use light emitting functions pointed in the direction of and too close to a person's face. Doing so creates the risk of loss of eyesight. In the case of infants and young children in particular, keep the light source at least one meter away the eyes. 
- Take care that your fingers, glove, or other items are not touching the flash window when you shoot. Touching the flash window can lead to burn injury, smoke, discoloration, or other problems. 
- Do not fire the flash while the flash window is dirty, dusty, or soiled with foreign matter. Doing so can lead to smoke emission and discoloration. 

Precautions During Use

■ Data Error Precautions

Your digital camera is manufactured using precision digital components. Any of the following creates the risk of corruption of data in camera memory.

- Removing the battery or memory card while the camera is performing some operation
- Removing the battery or memory card while the back lamp is flashing green after turning off the camera
- Disconnecting the USB cable while communication is in progress
- Shooting with a battery that quickly goes low right after it is charged
 - Shooting with a battery that quickly goes low right after it is charged can also cause camera malfunction. Replace the battery with a new one immediately.
- Other abnormal operations

Any of the above conditions can cause an error message to appear on the monitor screen (page 237). Perform the action indicated by the message that appears.

■ Operating Environment

- Operating Temperature Requirements: 0 to 40°C (32 to 104°F)
- Operating Humidity: 10 to 85% (non condensation)
- Do not place the camera in any of the following locations.
 - In an area exposed to direct sunlight, or large amounts of moisture, dust, or sand
 - Near heating or cooling devices, or in other areas subjected to extreme changes in temperature or humidity
 - Inside of a motor vehicle on a hot day, or in an area subjected to strong vibration

■ Condensation

Sudden and extreme temperature changes, such as when the camera is moved from the outdoors on a cold winter day into a warm room, can cause water droplets called “condensation” to form on the interior and the exterior of the camera, which creates the risk of malfunction. To prevent condensation from forming seal the camera in a plastic bag before changing locations. Then leave the bag sealed to allow the air inside to naturally change to the same temperature as the air in the new location. After that, remove the camera from the bag and open the battery cover for a few hours.

■ Lens

- Avoid all of the following, which can result in scratching of the lens surface or malfunction of the lens mechanism.
 - Applying too much force when wiping the lens surface.
 - Pressing from above on the lens barrier while the lens is retracted.
 - Trying to force a closed lens barrier to open.
- You may sometimes notice some distortion in certain types of images, such as a slight bend in lines that should be straight. This is due to the characteristics of lenses, and does not indicate malfunction of the camera.

■ Caring for your camera

- Never touch the lens or flash window with your fingers. Finger smudges, dirt, and other foreign matter on the lens or flash window can interfere with proper operation of the camera. Use a blower or other means to keep the lens and flash window free of dirt and dust, and wipe gently with a soft, dry cloth.
- To clean the camera, wipe it with a soft, dry cloth.

■ Old Rechargeable Battery Handling Precautions

- Insulate the positive and negative terminals with tape, etc.
- Do not peel the covering off of the battery.
- Do not try to take the battery apart.

■ Precautions During Wireless Function (Wireless LAN, Bluetooth Wireless Technology) Use

- Operation of this product may affect or may be affected by nearby devices that use wireless functionality.
- This product is subject to the Export Administration Regulations (EAR) of the United States, and so it cannot be exported to or brought into countries that fall under U.S. Embargoes and Other Special Controls.

Radio transmission interception

The radio waves that are used to send and receive data can be intercepted by third parties.

Unauthorized access

CASIO COMPUTER CO., LTD. shall be held in no way liable for any unauthorized access and/or use of the access point equipped on this product if the product is ever lost or stolen.

Use as a wireless device

Use the wireless functions of this product only as specifically described in this manual. Any other use is unintended use, and CASIO COMPUTER CO., LTD. shall be held in no way liable for any damages arising out of unintended use.

Magnetism, electrostatic charge, and radio interference

Do not use this product near a microwave oven or any other area where magnetism, electrostatic charge, or radio interference is generated. Radio wave reception may be poor in certain environments.

Also note that other devices using the same 2.4GHz band used by this product may cause reduced processing speeds in both devices.

Connection to a public LAN

This product does not support wireless LAN connection over a public wireless LAN environment.

Intended Areas of Use

This camera is intended for use in countries or areas listed at the website linked below.

<http://world.casio.com/r-law/dc/>

Even if you are in a country or area whose name is included in the list at the website linked above and even if your camera model is the same as the one described in this manual, your camera may not comply with radio laws and other laws in your area or country if you purchased a model intended for another country or area on the Internet, etc. In this case, it is up to you to determine if your camera can be used legally in your country or area.

Use of this camera in a country or area other than where it was originally purchased runs the risk of being in violation of local radio laws and other laws. Note that CASIO COMPUTER CO., LTD. shall not be held liable for any such violations.

■ Other Precautions

The camera becomes slightly warm during use. This is normal and does not indicate malfunction.

■ Copyrights

Except for your own personal enjoyment, unauthorized use of snapshots or movies of images whose rights belong to others, without the permission of the right holder, is forbidden by copyright laws. In some cases, shooting of public performances, shows, exhibitions, etc. may be restricted entirely, even if it is for your own personal enjoyment. Regardless of whether such files are purchased by you or obtained for free, posting them on a website, a file sharing site, or any other Internet site, or otherwise distributing them to third parties without the permission of the copyright holder is strictly prohibited by copyright laws and international treaties. For example, uploading or distributing on the Internet images of TV programs, live concerts, music videos, etc. that were photographed or recorded by you may infringe upon the rights of others. Note that CASIO COMPUTER CO., LTD. shall not be held liable for use of this product in any way that infringes on the copyrights of others or that violates copyright laws.

The following terms, which are used in this manual, are registered trademarks or trademarks of their respective owners.

Note that trademark [™] and registered trademark [®] are not used within the text of this manual.

- SDXC Logo is a trademark of SD-3C, LLC.
- Windows, Internet Explorer, Windows Media, Windows 7, Windows 8.1 and Windows 10 are registered trademarks or trademarks of Microsoft Corporation in the United States and other countries.
- Macintosh, Mac OS, QuickTime, and iPhone are trademarks of Apple Inc.
- Adobe and Reader are either registered trademarks or trademarks of Adobe Systems Incorporated in the United States and/or other countries.
- HDMI, the HDMI logo, and High-Definition Multimedia Interface are trademarks or registered trademarks of HDMI Licensing, LLC.
- Android and Google Play are trademarks or registered trademarks of Google Inc.

- App Store is a service mark of Apple Inc.
- iOS is a trademark or registered trademark of Cisco Systems, Inc. of the United States.
- Wi-Fi is a registered trademark of the Wi-Fi Alliance.
- The Bluetooth® word mark and logos are registered trademarks owned by Bluetooth SIG, Inc. and any use of such marks by CASIO COMPUTER CO., LTD. is under license. Other trademarks and trade names are those of their respective owners.
- The word “QR Code” is registered trademark of DENSO WAVE INCORPORATED in Japan and other countries.
- EXILIM and EXILIM Connect are registered trademarks or trademarks of CASIO COMPUTER CO., LTD.
- All other company or product names mentioned herein are registered trademarks or trademarks of their respective companies.

Any and all unauthorized copying, distribution, and transfer for commercial purposes of the software provided by CASIO for this product are prohibited.

■ Open Source Software

This product includes software that is licensed under the license conditions below.

OpenVG 1.1 Reference Implementation

Copyright (c) 2007 The Khronos Group Inc.

Permission is hereby granted, free of charge, to any person obtaining a copy of this software and /or associated documentation files (the "Materials "), to deal in the Materials without restriction, including without limitation the rights to use, copy, modify, merge, publish, distribute, sublicense, and/or sell copies of the Materials, and to permit persons to whom the Materials are furnished to do so, subject to the following conditions:

The above copyright notice and this permission notice shall be included in all copies or substantial portions of the Materials.

THE MATERIALS ARE PROVIDED "AS IS", WITHOUT WARRANTY OF ANY KIND, EXPRESS OR IMPLIED, INCLUDING BUT NOT LIMITED TO THE WARRANTIES OF MERCHANTABILITY, FITNESS FOR A PARTICULAR PURPOSE AND NONINFRINGEMENT. IN NO EVENT SHALL THE AUTHORS OR COPYRIGHT HOLDERS BE LIABLE FOR ANY CLAIM, DAMAGES OR OTHER LIABILITY, WHETHER IN AN ACTION OF CONTRACT, TORT OR OTHERWISE, ARISING FROM, OUT OF OR IN CONNECTION WITH THE MATERIALS OR THE USE OR OTHER DEALINGS IN THE MATERIALS.

bluedroid 5.0.0_r2

Copyright (c) 2014 The Android Open Source Project
Copyright (C) 1998-2014 Broadcom Corporation

Licensed under the Apache License, Version 2.0 (the "License");
you may not use this file except in compliance with the License.
You may obtain a copy of the License at
<http://www.apache.org/licenses/LICENSE-2.0>

Unless required by applicable law or agreed to in writing, software distributed under the License is distributed on an "AS IS" BASIS, WITHOUT WARRANTIES OR CONDITIONS OF ANY KIND, either express or implied. See the License for the specific language governing permissions and limitations under the License.

Apache License
Version 2.0, January 2004
<http://www.apache.org/licenses/>

TERMS AND CONDITIONS FOR USE, REPRODUCTION, AND DISTRIBUTION

1. Definitions.

"License" shall mean the terms and conditions for use, reproduction, and distribution as defined by Sections 1 through 9 of this document.
"Licensor" shall mean the copyright owner or entity authorized by the copyright owner that is granting the License.

"Legal Entity" shall mean the union of the acting entity and all other entities that control, are controlled by, or are under common control with that entity. For the purposes of this definition, "control" means (i) the power, direct or indirect, to cause the direction or management of such entity, whether by contract or otherwise, or (ii) ownership of fifty percent (50%) or more of the outstanding shares, or (iii) beneficial ownership of such entity.

"You" (or "Your") shall mean an individual or Legal Entity exercising permissions granted by this License.

"Source" form shall mean the preferred form for making modifications, including but not limited to software source code, documentation source, and configuration files.

"Object" form shall mean any form resulting from mechanical transformation or translation of a Source form, including but not limited to compiled object code, generated documentation, and conversions to other media types.

"Work" shall mean the work of authorship, whether in Source or Object form, made available under the License, as indicated by a copyright notice that is included in or attached to the work (an example is provided in the Appendix below).

"Derivative Works" shall mean any work, whether in Source or Object form, that is based on (or derived from) the Work and for which the editorial revisions, annotations, elaborations, or other modifications represent, as a whole, an original work of authorship. For the purposes of this License, Derivative Works shall not include works that remain separable from, or merely link (or bind by name) to the interfaces of, the Work and Derivative Works thereof.

"Contribution" shall mean any work of authorship, including the original version of the Work and any modifications or additions to that Work or Derivative Works thereof, that is intentionally submitted to Licensor for inclusion in the Work by the copyright owner or by an individual or Legal Entity authorized to submit on behalf of the copyright owner. For the purposes of this definition, "submitted" means any form of electronic, verbal, or written communication sent to the Licensor or its representatives, including but not limited to communication on electronic mailing lists, source code control systems, and issue tracking systems that are managed by, or on behalf of, the Licensor for the purpose of discussing and improving the Work, but excluding communication that is conspicuously marked or otherwise designated in writing by the copyright owner as "Not a Contribution."

"Contributor" shall mean Licensor and any individual or Legal Entity on behalf of whom a Contribution has been received by Licensor and subsequently incorporated within the Work.

2. Grant of Copyright License. Subject to the terms and conditions of this License, each Contributor hereby grants to You a perpetual, worldwide, non-exclusive, no-charge, royalty-free, irrevocable copyright license to reproduce, prepare Derivative Works of, publicly display, publicly perform, sublicense, and distribute the Work and such Derivative Works in Source or Object form.
3. Grant of Patent License. Subject to the terms and conditions of this License, each Contributor hereby grants to You a perpetual, worldwide, non-exclusive, no-charge, royalty-free, irrevocable (except as stated in this section) patent license to make, have made, use, offer to sell, sell, import, and otherwise transfer the Work, where such license applies only to those patent claims licensable by such Contributor that are necessarily infringed by their Contribution(s) alone or by combination of their Contribution(s) with the Work to which such Contribution(s) was submitted. If You institute patent litigation against any entity (including a cross-claim or counterclaim in a lawsuit) alleging that the Work or a Contribution incorporated within the Work constitutes direct or contributory patent infringement, then any patent licenses granted to You under this License for that Work shall terminate as of the date such litigation is filed.
4. Redistribution. You may reproduce and distribute copies of the Work or Derivative Works thereof in any medium, with or without modifications, and in Source or Object form, provided that You meet the following conditions:
 - (a) You must give any other recipients of the Work or Derivative Works a copy of this License; and
 - (b) You must cause any modified files to carry prominent notices stating that You changed the files; and
 - (c) You must retain, in the Source form of any Derivative Works that You distribute, all copyright, patent, trademark, and attribution notices from the Source form of the Work, excluding those notices that do not pertain to any part of the Derivative Works; and
 - (d) If the Work includes a "NOTICE" text file as part of its distribution, then any Derivative Works that You distribute must include a readable copy of the attribution notices contained within such NOTICE file, excluding those notices that do not pertain to any part of the Derivative Works, in at least one of the following places: within a NOTICE text file distributed as part of the Derivative Works; within the Source form or documentation, if provided along with the Derivative Works; or, within a display generated by the Derivative Works, if and

wherever such third-party notices normally appear. The contents of the NOTICE file are for informational purposes only and do not modify the License. You may add Your own attribution notices within Derivative Works that You distribute, alongside or as an addendum to the NOTICE text from the Work, provided that such additional attribution notices cannot be construed as modifying the License.

You may add Your own copyright statement to Your modifications and may provide additional or different license terms and conditions for use, reproduction, or distribution of Your modifications, or for any such Derivative Works as a whole, provided Your use, reproduction, and distribution of the Work otherwise complies with the conditions stated in this License.

5. **Submission of Contributions.** Unless You explicitly state otherwise, any Contribution intentionally submitted for inclusion in the Work by You to the Licensor shall be under the terms and conditions of this License, without any additional terms or conditions. Notwithstanding the above, nothing herein shall supersede or modify the terms of any separate license agreement you may have executed with Licensor regarding such Contributions.
6. **Trademarks.** This License does not grant permission to use the trade names, trademarks, service marks, or product names of the Licensor, except as required for reasonable and customary use in describing the origin of the Work and reproducing the content of the NOTICE file.
7. **Disclaimer of Warranty.** Unless required by applicable law or agreed to in writing, Licensor provides the Work (and each Contributor provides its Contributions) on an "AS IS" BASIS, WITHOUT WARRANTIES OR CONDITIONS OF ANY KIND, either express or implied, including, without limitation, any warranties or conditions of TITLE, NON-INFRINGEMENT, MERCHANTABILITY, or FITNESS FOR A PARTICULAR PURPOSE. You are solely responsible for determining the appropriateness of using or redistributing the Work and assume any risks associated with Your exercise of permissions under this License.
8. **Limitation of Liability.** In no event and under no legal theory, whether in tort (including negligence), contract, or otherwise, unless required by applicable law (such as deliberate and grossly negligent acts) or agreed to in writing, shall any Contributor be liable to You for damages, including any direct, indirect, special, incidental, or consequential damages of any character arising as a result of this License or out of the use or inability to use the Work (including but not limited to damages for loss of goodwill, work stoppage, computer failure or malfunction, or any and all other commercial damages or losses), even if such Contributor has been advised of the possibility of such damages.

9. Accepting Warranty or Additional Liability. While redistributing the Work or Derivative Works thereof, You may choose to offer, and charge a fee for, acceptance of support, warranty, indemnity, or other liability obligations and/or rights consistent with this License. However, in accepting such obligations, You may act only on Your own behalf and on Your sole responsibility, not on behalf of any other Contributor, and only if You agree to indemnify, defend, and hold each Contributor harmless for any liability incurred by, or claims asserted against, such Contributor by reason of your accepting any such warranty or additional liability.

END OF TERMS AND CONDITIONS

bluedroid 5.0.0_r2

Copyright (c) 1998-2008, Brian Gladman, Worcester, UK. All rights reserved.

LICENSE TERMS

The redistribution and use of this software (with or without changes) is allowed without the payment of fees or royalties provided that:

1. source code distributions include the above copyright notice, this list of conditions and the following disclaimer;
2. binary distributions include the above copyright notice, this list of conditions and the following disclaimer in their documentation;
3. the name of the copyright holder is not used to endorse products built using this software without specific written permission.

DISCLAIMER

This software is provided 'as is' with no explicit or implied warranties in respect of its properties, including, but not limited to, correctness and/or fitness for purpose.

libhardware 5.0.0_r2

Copyright (c) 2005-2014, The Android Open Source Project

Licensed under the Apache License, Version 2.0 (the "License"); you may not use this file except in compliance with the License. You may obtain a copy of the License at

<http://www.apache.org/licenses/LICENSE-2.0>

Unless required by applicable law or agreed to in writing, software distributed under the License is distributed on an "AS IS" BASIS, WITHOUT WARRANTIES OR CONDITIONS OF ANY KIND, either express or implied.

See the License for the specific language governing permissions and limitations under the License.

Apache License
Version 2.0, January 2004
<http://www.apache.org/licenses/>

TERMS AND CONDITIONS FOR USE, REPRODUCTION, AND DISTRIBUTION

1. Definitions.

"License" shall mean the terms and conditions for use, reproduction, and distribution as defined by Sections 1 through 9 of this document.

"Licensor" shall mean the copyright owner or entity authorized by the copyright owner that is granting the License.

"Legal Entity" shall mean the union of the acting entity and all other entities that control, are controlled by, or are under common control with that entity. For the purposes of this definition, "control" means (i) the power, direct or indirect, to cause the direction or management of such entity, whether by contract or otherwise, or (ii) ownership of fifty percent (50%) or more of the outstanding shares, or (iii) beneficial ownership of such entity.

"You" (or "Your") shall mean an individual or Legal Entity exercising permissions granted by this License.

"Source" form shall mean the preferred form for making modifications, including but not limited to software source code, documentation source, and configuration files.

"Object" form shall mean any form resulting from mechanical transformation or translation of a Source form, including but not limited to compiled object code, generated documentation, and conversions to other media types.

"Work" shall mean the work of authorship, whether in Source or Object form, made available under the License, as indicated by a copyright notice that is included in or attached to the work (an example is provided in the Appendix below).

"Derivative Works" shall mean any work, whether in Source or Object form, that is based on (or derived from) the Work and for which the editorial revisions, annotations, elaborations, or other modifications represent, as a whole, an original work of authorship. For the purposes of this License, Derivative Works shall not include works that remain separable from, or merely link (or bind by name) to the interfaces of, the Work and Derivative Works thereof.

"Contribution" shall mean any work of authorship, including the original version of the Work and any modifications or additions to that Work or Derivative Works thereof, that is intentionally

submitted to Licensor for inclusion in the Work by the copyright owner or by an individual or Legal Entity authorized to submit on behalf of the copyright owner. For the purposes of this definition, "submitted" means any form of electronic, verbal, or written communication sent to the Licensor or its representatives, including but not limited to communication on electronic mailing lists, source code control systems, and issue tracking systems that are managed by, or on behalf of, the Licensor for the purpose of discussing and improving the Work, but excluding communication that is conspicuously marked or otherwise designated in writing by the copyright owner as "Not a Contribution."

"Contributor" shall mean Licensor and any individual or Legal Entity on behalf of whom a Contribution has been received by Licensor and subsequently incorporated within the Work.

2. Grant of Copyright License. Subject to the terms and conditions of this License, each Contributor hereby grants to You a perpetual, worldwide, non-exclusive, no-charge, royalty-free, irrevocable copyright license to reproduce, prepare Derivative Works of, publicly display, publicly perform, sublicense, and distribute the Work and such Derivative Works in Source or Object form.
3. Grant of Patent License. Subject to the terms and conditions of this License, each Contributor hereby grants to You a perpetual, worldwide, non-exclusive, no-charge, royalty-free, irrevocable (except as stated in this section) patent license to make, have made, use, offer to sell, sell, import, and otherwise transfer the Work, where such license applies only to those patent claims licensable by such Contributor that are necessarily infringed by their Contribution(s) alone or by combination of their Contribution(s) with the Work to which such Contribution(s) was submitted. If You institute patent litigation against any entity (including a cross-claim or counterclaim in a lawsuit) alleging that the Work or a Contribution incorporated within the Work constitutes direct or contributory patent infringement, then any patent licenses granted to You under this License for that Work shall terminate as of the date such litigation is filed.
4. Redistribution. You may reproduce and distribute copies of the Work or Derivative Works thereof in any medium, with or without modifications, and in Source or Object form, provided that You meet the following conditions:
 - (a) You must give any other recipients of the Work or Derivative Works a copy of this License; and
 - (b) You must cause any modified files to carry prominent notices stating that You changed the files; and
 - (c) You must retain, in the Source form of any Derivative Works that You distribute, all copyright, patent, trademark, and attribution notices from the Source form of the Work,

excluding those notices that do not pertain to any part of the Derivative Works; and

- (d) If the Work includes a "NOTICE" text file as part of its distribution, then any Derivative Works that You distribute must include a readable copy of the attribution notices contained within such NOTICE file, excluding those notices that do not pertain to any part of the Derivative Works, in at least one of the following places: within a NOTICE text file distributed as part of the Derivative Works; within the Source form or documentation, if provided along with the Derivative Works; or, within a display generated by the Derivative Works, if and wherever such third-party notices normally appear. The contents of the NOTICE file are for informational purposes only and do not modify the License. You may add Your own attribution notices within Derivative Works that You distribute, alongside or as an addendum to the NOTICE text from the Work, provided that such additional attribution notices cannot be construed as modifying the License.

You may add Your own copyright statement to Your modifications and may provide additional or different license terms and conditions for use, reproduction, or distribution of Your modifications, or for any such Derivative Works as a whole, provided Your use, reproduction, and distribution of the Work otherwise complies with the conditions stated in this License.

5. **Submission of Contributions.** Unless You explicitly state otherwise, any Contribution intentionally submitted for inclusion in the Work by You to the Licensor shall be under the terms and conditions of this License, without any additional terms or conditions. Notwithstanding the above, nothing herein shall supersede or modify the terms of any separate license agreement you may have executed with Licensor regarding such Contributions.
6. **Trademarks.** This License does not grant permission to use the trade names, trademarks, service marks, or product names of the Licensor, except as required for reasonable and customary use in describing the origin of the Work and reproducing the content of the NOTICE file.
7. **Disclaimer of Warranty.** Unless required by applicable law or agreed to in writing, Licensor provides the Work (and each Contributor provides its Contributions) on an "AS IS" BASIS, WITHOUT WARRANTIES OR CONDITIONS OF ANY KIND, either express or implied, including, without limitation, any warranties or conditions of TITLE, NON-INFRINGEMENT, MERCHANTABILITY, or FITNESS FOR A PARTICULAR PURPOSE. You are solely responsible for determining the appropriateness of using or redistributing the Work and assume any risks associated with Your exercise of permissions under this License.

8. **Limitation of Liability.** In no event and under no legal theory, whether in tort (including negligence), contract, or otherwise, unless required by applicable law (such as deliberate and grossly negligent acts) or agreed to in writing, shall any Contributor be liable to You for damages, including any direct, indirect, special, incidental, or consequential damages of any character arising as a result of this License or out of the use or inability to use the Work (including but not limited to damages for loss of goodwill, work stoppage, computer failure or malfunction, or any and all other commercial damages or losses), even if such Contributor has been advised of the possibility of such damages.
9. **Accepting Warranty or Additional Liability.** While redistributing the Work or Derivative Works thereof, You may choose to offer, and charge a fee for, acceptance of support, warranty, indemnity, or other liability obligations and/or rights consistent with this License. However, in accepting such obligations, You may act only on Your own behalf and on Your sole responsibility, not on behalf of any other Contributor, and only if You agree to indemnify, defend, and hold each Contributor harmless for any liability incurred by, or claims asserted against, such Contributor by reason of your accepting any such warranty or additional liability.

END OF TERMS AND CONDITIONS

Charging

■ If the camera's back lamp starts flashing red...

If the back lamp starts flashing red during charging, it means that further charging is not possible for one of the reasons below. Perform the actions described below to correct the problem and then try charging again.

Ambient temperature or the temperature of the battery is abnormally high or low

Unplug the USB cable from the camera and wait for a while until the camera is within the temperature range of 15°C to 35°C (59°F to 95°F), and then try charging again.

Safety timer activated

A battery that has not been used for a long time, certain types of computers, and connection conditions can cause charging to take longer than normal. If charging takes longer than about 5 hours, a safety timer will terminate it automatically, even if the battery is not fully charged. If the battery has not been used for a very long time, charging may terminate automatically after only about 60 minutes.

- 1) Using a battery that has not been used for a long time.
Disconnect and then reconnect the USB cable to resume charging.
- 2) Insufficient power supply when connected to computer
The camera can be charged only via a USB 2.0 standard USB port. Connect directly to a USB port what supplies a current of 500mA.

For details about the power supply capacity of a computer's USB port, contact the manufacturer of the computer. Though disconnecting and then reconnecting the USB cable will resume charging, you may need to do so repeatedly if the power supply capacity of the computer is low.

If problems persist after you perform the above steps or if the battery fails to charge after 5 hours, it could mean that the battery is faulty. Contact your nearest CASIO authorized service center.

Battery Precautions

■ Precautions during Use

- Operation provided by a battery under cold conditions is always less than operation under normal temperatures. This is due to the characteristics of the battery, not the camera.
- Charge the battery in an area where the temperature is within the range of 15°C to 35°C (59°F to 95°F). Outside this temperature range charging can take longer than normal or even fail.
- Do not tear or remove the battery outer label.
- If a battery provides only very limited operation following a full charge, it probably means the battery has reached the end of its service life. Replace the battery with a new one.

■ Storage Precautions

- Storing the battery for a long time while it is charged can cause deterioration of battery characteristics. If you do not plan to use a battery for some time, fully use up its charge before storing it.
- Always remove the battery from the camera when you are not using it. A battery left in the camera can discharge and go dead, which will require some time to charge when you need to use the camera.
- Store batteries in a cool, dry place (20°C (68°F) or lower).
- To prevent over discharging of an unused battery, fully charge it, and then load it in the camera and fully use up the charge about once every six months.

Using the Camera in another Country

■ Precautions during Use

- The bundled USB-AC adaptor is designed for operation with any power supply in the range of 100V to 240V AC, 50/60Hz. Note, however, that the shape of the power plug depends on each country or geographic area. Before taking the camera and USB-AC adaptor along on a trip, check with travel agent about the power supply requirements in your destination(s).
- Do not connect the USB-AC adaptor to a power supply through a voltage converter or similar device. Doing so can lead to malfunction.

■ Extra Batteries

- Taking along extra fully charged batteries (NP-130A) is recommended while on a trip in order to avoid not being able to shoot images due to the battery going dead.

Using a Memory Card

See page 29 for information about supported memory cards and how to load a memory card.

■ Using a Memory Card

- SD memory cards, SDHC memory cards, and SDXC memory cards have a write protect switch. Use the switch when you need to guard against accidentally deleting data. Note, however, if you write protect an SD memory card you must then turn write protection off whenever you want to record to it, format it, or delete any of its images.
- If a memory card starts to behave abnormally during image playback, you can restore normal operation by reformatting it (page 201). However, it is recommended that you always take along multiple memory cards whenever using the camera far away from the home or office.
- As you record data to and delete data from a memory card a number of times, it loses its ability to retain data. Because of this, periodic re-formatting of a memory card is recommended.
- Electrostatic charge, electrical noise, and other phenomena can cause data to become corrupted or even lost. Make sure that you always back up important data on other media (Blu-ray, DVD, or other optical disk, hard disk, etc.).

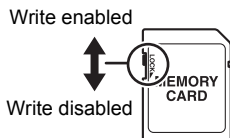

■ Memory Card Handling Precautions

Certain types of memory cards can slow down processing speed. Whenever possible use an Ultra High-Speed Type memory card. Note, however, that not all operations can be guaranteed even if an Ultra High-Speed Type memory card is used. Certain movie quality settings can result in too much time being required to record data, which can result in breaks in the image and/or audio during playback. If this happens, the **REC** will turn yellow on the monitor screen.

■ Discarding or Transferring Ownership of a Memory Card or the Camera

The format and delete functions of the camera do not actually delete files from the memory card. The original data remains on the card. Note that responsibility for the data on a memory card lies with you. The following procedures are recommended whenever you discard a memory card or the camera, or if you transfer ownership to another party.

- When discarding a memory card, either physically destroy the memory card or use commercially available data delete software to completely delete the data on the memory card.
- When transferring ownership of a memory card to another party, use commercially available data deletion software to completely delete the data on it.

Use the format function (page 201) to completely delete the data in built-in memory before discarding or transferring ownership of the camera.

Reset Initial Default Settings

The tables in this section show the initial default settings that are configured for menu items (displayed when you press [MENU]) after you reset the camera (page 202). Menu items depend on whether the camera is in the REC mode or PLAY mode.

- A dash (–) indicates an item whose setting is not reset or an item for which there is no reset setting.



IMPORTANT!

- Depending on the recording mode, some of the items on the menu that appears may not be usable.

■ REC MENU

CS	Off
Motion Shutter	Motion Settings: Off Timer: 2 sec Motion Position: ⦿ : Upper right ⦿ : Upper left
Front Shutter	Standard
Key Customize	Function Ring: Step Zoom Control Dial : Off L/R Key: Off
L/R Flip Shot	Off
Self-timer	Off
Exposure	0.0
White Balance	Auto WB
ISO	Auto
ISO High Limit	Auto
Focus	AF
AF Area	 Spot
Face Detection	Off
Make-up	Smooth Skin: 0 Skin Tone: Natural Face Brightness: 0 Sculpt: 0
Continuous AF	Off
Metering	Multi
Anti-shake Functions	Standard

Image Size	12M
Image Quality	Normal
Movie Quality	FHD
Lighting	On
Sharpness	0
Saturation	0
Contrast	0
Flash Intensity	0
Zoom (SR)	Single
Digital Zoom	On
AF Assist Light	On
Double (HDR Art)	On
Wind Noise Cut	Off
Review	Type 2
Icon Help	On
Shooting Info	Grid: Off / Histogram: Off / Movie Range: Off

Memory	Function Ring: On / CS: Off / Flash: On / Focus: Off / ISO: Off / White Balance: Off / Exposure: Off / AF Area: On / Metering: Off / Self-timer: Off / Flash Intensity: Off / Zoom (SR): On / Digital Zoom: On / MF Position: Off / Zoom Position: Off
---------------	--

■ PLAY MENU

Front Shutter	Standard
Function Ring	–
Highlight Functions	–
Slideshow	Images: All images / Time: 30 min / Interval: 3 sec / Effect: Pattern 1
Make Movie	–
Movie Editing	–
Movie Merge	–
MOTION PRINT	–
Lighting	–



White Balance	–
Brightness	0
DPOF Printing	–
Protect	–
Date/Time	–
Rotation	–
Resize	8M
Trimming	–
Copy	–
CS Multi Print	–
Divide Group	–
Edit Group	–

■ SETTING

ECO Mode	Off
Screen	Auto
Sounds	Startup: Sound 1 / Half Shutter: Sound 1 / Shutter: Sound 1 / Operation: Sound 1 / Operation Vol: 3 / Playback Vol: 3
Create Folder	–
Timestamp	Off
Auto Rotate	On
File No.	Continue
Sleep	1 min
Auto Power Off	5 min

Screen Tilt	Power On
PLAY	Power On
Delete Key	Enabled
World Time	–
Adjust	–
Date Style	–
Language	–
HDMI Output	Auto
Format	–
Reset	–
Version	–







■ Wireless settings





Airplane Mode	Off
Auto Send	Off
Auto Send File Settings	 
Resize before send	3M
Location info	Off
WLAN password	–
Unpairing	–

When things don't go right...



Troubleshooting

Problem	Possible Cause and Recommended Action
Power Supply	
Power does not turn on.	<ol style="list-style-type: none">1)The battery may not be loaded correctly (page 21).2)The battery may be dead. Charge the battery (page 22). If the battery goes dead soon after being charged, it means the battery has reached the end of its life and needs to be replaced. Purchase a separately available CASIO NP-130A rechargeable lithium ion battery.
The camera suddenly powers down.	<ol style="list-style-type: none">1)Auto Power Off may have activated (page 197). Turn power back on.2)The battery may be dead. Charge the battery (page 22).3)The camera's protection function may have activated because camera temperature is too high. Turn off the camera and wait until it cools down before trying to use it again.
Power will not turn off. Nothing happens when a button is pressed.	Remove the battery from the camera and then reload them.
Charging	
The back lamp does not light red and the battery won't charge.	<ol style="list-style-type: none">1)Unplug the USB cable from the camera and then plug it back in again.2)Remove the battery from the camera and then reload it (page 22).
Image Recording	
Image is not recorded when the shutter button is pressed.	<ol style="list-style-type: none">1)If the camera is in the PLAY mode, press the shutter button to enter the REC mode.2)If the flash is charging, wait until the charge operation finishes.3)If the message "Memory Full" appears, transfer images to your computer, delete images you no longer need, or use a different memory card.
Auto Focus does not focus properly.	<ol style="list-style-type: none">1)If the lens is dirty, clean it off.2)The subject may not be in the center of the focus frame when you compose the image.3)The subject you are shooting may not be a type that is compatible with Auto Focus (page 41). Use manual focus (page 48).4)You may be moving the camera when shooting. Try shooting with Anti Shake or use a tripod.

Problem	Possible Cause and Recommended Action
The subject is out of focus in the recorded image.	The image may not be focused properly. When composing the image, make sure the subject is located inside the focus frame.
The flash does not fire.	<ol style="list-style-type: none"> 1) If  (Flash Off) is selected as the flash mode, change to another mode (page 53). 2) If the battery is low, charge it (page 22). 3) If a BEST SHOT scene that uses  (Flash Off) is selected, change to a different flash mode (page 53) or select a different BEST SHOT scene (page 89).
The red  (Flash Off) icon is displayed on the monitor screen and the flash does not fire.	The flash unit may be malfunctioning. Contact a CASIO authorized service center or your original retailer. Note that though the flash will not fire, you still can use the camera for non-flash shots.
Camera powers down during Self-timer countdown.	The battery may be low. Charge the battery.
The monitor screen image is out of focus.	<ol style="list-style-type: none"> 1) You may be using Manual Focus and have not focused the image. Focus the image (page 48). 2) You may be using  (Macro) for scenery or portraits. Use Auto Focus for scenery and portrait shots (page 48). 3) You may be trying to use Auto Focus when shooting a close-up shot. Use the  (Macro) for close ups (page 48).
There is digital noise in images.	<ol style="list-style-type: none"> 1) Sensitivity may have been increased automatically for a dark subject, which increases the chance of digital noise. Use a light or some other means to illuminate the subject. 2) You may be attempting to shoot in a dark location with  (Flash Off) selected, which can increase digital noise and make images appear coarse. In this case, turn on flash (page 53) or use lights for illumination. 3) Lighting (page 124) may be enabled for snapshots, which can cause an increase in digital noise. Use a light or some other means to illuminate the subject. 4) Shooting movies for long periods in areas where temperature is relatively high can cause digital noise (dots of light) to appear in the movie image. If this happens, move to a cooler environment or turn off the camera and allow it to cool down, which should cause normal operation to resume.

Problem	Possible Cause and Recommended Action
A recorded image was not saved.	1) Camera power may have been turned off before the save operation was complete, which will result in the image not being saved. If the battery indicator shows  , charge the battery as soon as possible (page 26). 2) You may have removed the memory card from the camera before the save operation was complete, which will result in the image not being saved. Do not remove the memory card before the save operation is complete.
Though available lighting is bright, the faces of people in the image are dark.	Not enough light is reaching the subjects. Change the flash mode setting to  (Flash On) for daylight synchro flash (page 53), or adjust Exposure to the + side (page 52).
Night shots come out bad.	Use the following BEST SHOT scenes (page 89) when shooting at night. <ul style="list-style-type: none"> • HS Night Scene (for shooting night scenery only) • HS Night Scene and Portrait (for shooting people against night scenery)
Subjects are too dark when shooting images in a seashore or ski area.	Sunlight reflected by water, sand, or snow, can cause underexposure of images. Change the flash mode setting to  (Flash On) for daylight synchro flash (page 53), or adjust Exposure to the + side (page 52).
Digital zoom will not go up to the maximum value.	1) The digital zoom setting may be turned off. Turn on digital zoom (page 125). 2) Zoom will not go up to the maximum value if the “Zoom (SR)” setting is “Single”. Change the setting to “Off” (page 59). 3) Zoom will not go up to the maximum value if the snapshot size setting is something other than “3M”. Change to a different setting (page 121).
The image is out of focus during movie recording.	1) Focusing may not be possible because the subject is outside the focus range. Shoot within the allowable range. 2) The lens may be dirty. Clean the lens (page 211). 3) During High Speed Movie recording, focus is fixed at the position where it was when recording started. To focus an image, half-press the shutter button for Auto Focus or focus manually before you press  (Movie) to start recording.
Movie recording suddenly stops.	The camera’s protection function may have activated because camera temperature is too high. Wait until the camera temperature drops to normal levels.
The monitor screen goes blank and camera operation becomes disabled.	Selecting S or M for the recording mode and using a slow shutter speed will cause the monitor screen to go blank during the period from when the shutter button is pressed until image recording is complete. Camera operations are disabled during this time. Wait until the back lamp goes out and an image appears on the monitor screen again.

Problem	Possible Cause and Recommended Action
I can't change the settings of menu items. Menu items for some settings are not displayed on the menu.	Some menu items may not be available, depending on the recording mode in use. While Premium Auto Pro is in use, only the menu items whose settings can be configured will be displayed on the menus.
Playback	
The color of the playback image is different from what appears on the monitor screen when shooting.	Sunlight or light from another source may be shining directly into the lens when you are shooting. Position the camera so sunlight does not shine directly into the lens.
Images are not displayed.	This camera cannot display non-DCF images recorded onto a memory card using another digital camera.
Images cannot be edited (with White Balance, Brightness, Resize, Trimming, Rotation).	<p>Note that you cannot edit the following types of snapshots.</p> <ul style="list-style-type: none"> • Snapshots created using MOTION PRINT • CS and interval shot group snapshots • Movies • Panorama Image • Snapshots recorded with another camera
File Deletion	
A file cannot be deleted.	<ol style="list-style-type: none"> 1)The file may be protected. Unprotect the file (page 151). 2)"Delete Key" setting may be "Disabled". Change the setting to "Enabled" (page 198).
Wireless Connection	
I can't establish a wireless connection. The wireless connection is broken.	<ol style="list-style-type: none"> 1)The camera cannot connect with a smartphone if they are too far apart from each other. 2)The smartphone may be connected with another wireless device. Check the smartphone's Wi-Fi settings and confirm that the camera is selected for wireless connection (page 163). 3)Connection may have been lost due to interference caused by a nearby microwave oven, cordless phone, or other wireless device. Move the camera away from the device causing the problem.
Location Information	
Location information isn't being added to my images.	<ol style="list-style-type: none"> 1)Pair the camera and smartphone, and then establish a Bluetooth wireless technology connection between them. 2)If you are shooting snapshots, select "On" for the camera's location information setting (page 176). 3)Configure smartphone settings to acquire location information, and make sure it is where location information can be received.

Problem	Possible Cause and Recommended Action
Other	
The wrong date and time are displayed, or the wrong date and time are being stored along with image data.	The date and time setting is off. Set the correct date and time (page 200).
The messages on the display are in the wrong language.	The wrong display language is selected. Change the display language setting (page 201).
Images cannot be transferred over a USB connection.	<ol style="list-style-type: none"> 1)The USB cable may not be connected securely. Check all connections. 2)If the camera is not turned on, turn it on. 3)Your computer may not be able to recognize the camera if you connect via a USB hub. Always connect directly to the computer's USB port. 4)USB communication may not be possible when the battery level indicator is . Charge the battery before connecting.
Language selection screen appears when the camera is turned on.	<ol style="list-style-type: none"> 1)You did not configure initial settings after purchasing the camera or the camera may have been left with a dead battery. Configure the correct settings (pages 26, 201). 2)There may be a problem with the camera's memory data. If this is the case, perform the reset operation to initialize the camera's setup (page 202). After that, configure each setting. If the language selection screen does not re-appear when you turn the camera on, it means that the camera's memory management data has been restored. If the same message appears after you turn power back on, contact your retailer or a CASIO authorized service center.
There are various indicators and values on the monitor screen.	The monitor screen shows indicators and other information about shooting conditions and the image you are recording. You can use [] (DISP) to select what information you want to include on the display (page 13).

Problem	Possible Cause and Recommended Action
<p>The time and date settings configured the first time after purchasing the camera are reset to their factory defaults when I remove the camera's battery.</p>	<p>Load the camera's battery and reconfigure the time and date settings (page 26). Do not remove the battery from the camera for at least 24 hours after configuring time and date settings. After that, the settings will not be reset if you remove the battery.</p> <ul style="list-style-type: none"> • If the time and date are reset to their factory default settings when you remove the battery after it has been loaded for more than 24 hours, it could mean that the camera's setting memory is defective. Contact your retailer or a CASIO authorized service center.
<p>Buttons are not responsive right after the power has been turned on.</p>	<p>With large capacity memory cards there is a delay after the power has been turned on before the buttons become responsive.</p>

Display Messages

Battery is low.	Battery power is low.
Can not find the file.	The image you specified with the slideshow “Images” setting cannot be found. Change the “Images” setting (page 144) and try again.
Card ERROR	<p>There is something wrong with the memory card. Turn off the camera, remove the memory card and then reload it into the camera. If this message re-appears when you turn the camera back on, format the memory card (page 201).</p> <p> IMPORTANT!</p> <ul style="list-style-type: none">• Formatting a memory card deletes all its files. Before formatting, try transferring recoverable files to a computer or some other storage device.
Communication stopped.	This message appears when the wireless LAN connection is broken for some reason during data communication between the camera and smartphone.
File could not be saved because battery is low.	Battery power is low, so an image file could not be saved.
Folder cannot be created.	You are trying to record a file while there are already 9999 files stored in the 999th folder. If you want to record more, delete files you no longer need (page 39).
LENS ERROR	This message appears and the camera turns off whenever the lens performs some unexpected operation. If the same message appears after you turn power back on, contact a CASIO authorized service center or your original retailer.
LENS ERROR 2	The Anti Shake unit of the camera may be malfunctioning. If the same message appears after you turn power back on, contact your retailer or a CASIO authorized service center.
Memory Full	Memory is full with images you recorded and/or files saved by editing operations. When shooting with Prerecord CS, this message indicates that there is not enough memory capacity to record all of the pre-recorded images. Delete files you no longer need (page 39).
Overheating. Power will turn off.	The camera’s protection function may have activated because camera temperature is too high. Turn off the camera and wait until it cools down before trying to use it again.

Record Error	Image compression could not be performed for some reason during image data recording. Perform a zoom operation to change the composition of the image and shoot it again.
RETRY POWER ON	The lens came into contact with an obstruction while moving. The camera will turn off automatically when this message appears. Remove the obstruction and turn power back on again.
Send failed.	An image send operation could not be performed completely for some reason.
The card is locked.	The LOCK switch of the SD, SDHC, or SDXC memory card loaded in the camera is in the locked position. You cannot store images to or delete images from a memory card that is locked. <div style="text-align: right;"> <p>LOCK</p>  </div>
There are no files.	There are no files in built-in memory or on the memory card.
There are not enough images for this operation.	A Highlight Photo or Highlight Movie could not be generated because there were not enough files required for generation.
There is no image to register.	The setup you are trying to save is for an image that cannot be saved as a user "Custom Shot" scene.
This card is not formatted.	The memory card loaded in the camera is not formatted. Format the memory card (page 201).
This file cannot be played.	The file you are trying to access is corrupted or is a type that cannot be displayed by this camera.
This function cannot be used.	This message will appear part way through an operation when you attempt to use a function that is not allowed in combination with another function.

Number of Snapshots/Movie Recording Time

Snapshot

Image Size (Pixels)	Quality	File Size	Built-in Memory* ¹ Recording Capacity	SD Memory Card* ² Recording Capacity
12M (4000×3000)	Fine	7.87 MB	2	1453
	Normal	4.13 MB	4	2221
3:2 (4000×2656)	Fine	6.87 MB	3	1672
	Normal	3.62 MB	4	2549
16:9 (4000×2240)	Fine	5.66 MB	3	2019
	Normal	3.0 MB	5	3048
8M (3264×2448)	Fine	5.66 MB	3	2019
	Normal	3.0 MB	5	3048
3M (2048×1536)	Fine	2.0 MB	8	4669
	Normal	1.25 MB	11	6533

Movies

Image Size/ Pixels (Audio)	Approximate Data Rate (Frame Rate)	Maximum File Size	Built-in Memory*1 Recording Capacity	Maximum Recording Time with SD Memory Card*2	File Size of 1-minute Movie	Continuous Recording Time per Movie*3
FHD (1920×1080) (Stereo)	14.2 Megabits/ second (30 frames/second)	4GB or 29 minutes	13 seconds *4	2 hours 13 minutes	106.5 MB	29 minutes
HD (1280×720) (Stereo)	10.9 Megabits/ second (12, 15, 20, 30 frames/second)		18 seconds *5	2 hours 53 minutes *5	81.8 MB *5	29 minutes *5
STD (640×480) (Stereo)	3.9 Megabits/second (30 frames/second)		53 seconds	8 hours 12 minutes	29.3 MB	29 minutes
HS1000 (224×64) (No audio)	40.0 Megabits/ second (1000 frames/ second)		5 seconds *4	48 minutes	300.0 MB	13 minutes 10 seconds
HS480 (224×160) (No audio)	40.0 Megabits/ second (480 frames/second)		5 seconds *4	48 minutes	300.0 MB	13 minutes 2 seconds
HS240 (512×384) (No audio)	40.0 Megabits/ second (240 frames/second)		5 seconds *4	48 minutes	300.0 MB	12 minutes 58 seconds
HS120 (640×480) (No audio)	40.0 Megabits/ second (120 frames/second)		5 seconds *4	47 minutes	300.0 MB	12 minutes 55 seconds
HS30-240 (512×384) (Audio recording at 30 fps only)	5.4 Megabits/second (30 frames/second) 40.4 Megabits/ second (240 frames/second)		38 seconds *4*6	5 hours 59 minutes *6	40.5 MB *6	29 minutes *6
HS30-120 (640×480) (Audio recording at 30 fps only)	10.4 Megabits/ second (30 frames/second) 40.4 Megabits/ second (120 frames/second)		20 seconds *4*6	3 hours 5 minutes *6	78.0 MB *6	29 minutes *6

*1 Built-in memory capacity after formatting (Approx. 27.6MB)

*2 When using a 16GB SDHC memory card (SanDisk Corporation). Number of image and recording time values depend on the memory card you are using.

*3 The allowable recording time will be shorter if the capacity of the SD memory card you are using is smaller than the maximum size of one file.

*4 The data transfer rate of built-in memory is not sufficient for FHD and HS movies. Whenever possible use an Ultra High-Speed Type memory card (pages 29, 79).

*5 Values when shooting with Art Shot.

*6 Recordable time when the entire movie is recorded at 30 fps. Recording time is shorter if the 30 fps frame rate is switched to 120 fps or 240 fps during recording.

- Snapshot and movie recording capacity values are approximate and intended for reference only. Actual capacity depends on image contents.
 - File size and data rate values are approximate and intended for reference only. Actual values depend on the type of image being shot.
 - When using a memory card with a different capacity, calculate the number of images as a percentage of 16GB.
 - The time it takes to play back a high speed movie will be different from the time it takes to record it. If you record a 240 fps high speed movie for 10 seconds, for example, it will take 80 seconds to play it back.
-

Specifications

File Format	Snapshots: RAW (DNG)*, JPEG (Exif Version 2.3; DCF 2.0 standard; DPOF compliant) Movies: MOV format, H.264/AVC standard, IMA-ADPCM (stereo) * DNG file format is one type of RAW image file, and it is recommended by Adobe Systems Incorporated for use as a standard image file format.
Recording Media	Built-in Memory (Image Storage Area: 27.6MB*) SD/SDHC/SDXC * Built-in memory capacity after formatting
Recorded Image Sizes	Snapshots: 12M (4000×3000), 3:2 (4000×2656), 16:9 (4000×2240), 8M (3264×2448), 3M (2048×1536) Movies: FHD (1920×1080 30 fps), HD (1280×720 12 fps/15 fps/20 fps/30 fps)*, STD (640×480 30 fps), HS1000 (224×64 1000 fps), HS480 (224×160 480 fps), HS240 (512×384 240 fps), HS120 (640×480 120 fps), HS30-240 (512×384 30 fps/240 fps switchable), HS30-120 (640×480 30 fps/120 fps switchable) * HD movie can be selected only when shooting with Art Shot or some Time Lapse scenes.
Effective Pixels	12.1 Megapixels
Imaging Element	Size: 1/1.7-inch CMOS (back illuminated type) Total Pixels: 12.76 Megapixels
Lens/Focal Distance	F2.7 (W) to 6.4 (T) f = 4.06 to 20.3 mm (equivalent to 19 to 95 mm in 35 mm format)
Zoom	5.0X Optical zoom, 10.0X in combination with Multi SR Zoom 4X Digital zoom Up to 39.0X when HD Zoom and Digital zoom are used in combination (3M size)
Focusing	Contrast Detection Auto Focus; with AF assist light • Focus Modes: Auto Focus, Macro Focus, Manual Focus • AF Area: Intelligent, Spot, Multi (25 selectable areas), Tracking
Approximate Focus Range (From Lens Surface)	Auto Focus: 3 cm to ∞ (1.2" to ∞) (Wide Angle) Macro Focus: 3 cm to 30 cm (1.2" to 11.8") (Wide Angle) Manual Focus: 3 cm to ∞ (1.2" to ∞) (Wide Angle) • Range is affected by optical zoom.
Metering	Multi-pattern, center weighted, and spot
Exposure Control	Program AE, Aperture Priority AE, Shutter Speed Priority AE, Manual Exposure

Exposure Compensation	-2.0 EV to +2.0 EV (in 1/3EV steps)
Shutter	CMOS electronic shutter, mechanical shutter
Shutter Speed	Snapshot (Program Auto): 1/4 to 1/1600 second Snapshot (Premium Auto Pro): 4 to 1/4000 second Snapshot (Aperture Priority AE): 1 to 1/1600 second Snapshot (Shutter Speed Priority AE): 15 to 1/1600 second Snapshot (Manual Exposure): 30 to 1/1600 second • 1/20000-second shutter speed is possible only with High speed Continuous Shutter, shutter speed priority AE or manual exposure. • May differ due to the camera setup.
Aperture Value	F2.7/F6.9(W), F6.4/F16.3(T) (With ND filter) • Using optical zoom changes the aperture value.
White Balance	Auto, Daylight, Overcast, Shade, Day White Fluorescent, Daylight Fluorescent, Tungsten, Manual WB
ISO Sensitivity (Standard Output Sensitivity)	Snapshots: Auto, ISO 80, ISO 100, ISO 200, ISO 400, ISO 800, ISO 1600, ISO 3200, ISO 6400 Snapshots (HS Night Shot): ISO 25600 maximum Movies: Auto
Flash Modes	Auto, Off, On, Red-eye reduction
Flash Range (ISO Sensitivity: Auto)	0.4 m to 4.3 m (1.3' to 14.1') (Wide Angle) 0.6 m to 1.8 m (2.0' to 5.9') (Telephoto) • Range is affected by optical zoom.
Flash Intensity Adjustment	-2, -1, 0, +1, +2
Flash Charging Time	Approximately 5 seconds
Communication function	Bluetooth: • Communication standard: Bluetooth® Ver.4.0 Wi-Fi: • Standard: IEEE 802.11b/g/n • Operation frequency range: 1 to 11ch • Encryption: WPA2
Monitor Screen	3.0-inch TFT color LCD 921,600 dots, tiltable (180 degrees)
External connection terminal	Micro USB port (Hi-Speed USB compliance, USB charging) HDMI output (Micro/TypeD)
Microphones	Stereo
Speaker	Monaural
Power Requirements	Rechargeable lithium ion battery (NP-130A) ×1

Approximate Battery Life

All of the values provided below represent the approximate amount of time under normal temperature (23°C (73°F)) before the camera turns off. These values are not guaranteed. Low temperatures shorten battery life.

Number of Shots (Operating Time)*¹	430 shots
Number of Shots (ECO)*¹	500 shots
Actual movie recording time (FHD Movie)*¹	1 hour 30 minutes
Approximate continuous movie recording time (FHD Movie)*²	2 hours 25 minutes
Approximate continuous movie recording time (High speed movie (HS 240))*²	2 hours 45 minutes
Approximate time lapse recording time*² (FHD Movie*³)	4 hours
Continuous Playback (Snapshots)*⁴	6 hours 25 minutes

- Temperature: 23°C (73°F)
- Battery: NP-130A (Rated Capacity: 1800 mAh)
- Recording Medium: 16GB SDHC memory card (SanDisk Corporation)

*¹ In accordance with CIPA (Camera and Imaging Products Association) standards

*² In accordance with CASIO standards

*³ Other settings

Time Lapse scene:  Standard, Recording interval: 1/2 seconds, Total time: Off, Sleep: 1 minute

*⁴ One-image scroll approximately every 10 seconds

- The above values are based a new battery, starting from a full charge. Repeated charging shortens battery life.
- The above values are for reference only. They do not guarantee that the specified battery life will be attained under actual operating conditions.
- Frequency of flash, zoom, Auto Focus, and High Speed CS usage, configured settings, the amount of time the camera is left turned on, and ambient temperature in the area where the camera is used all greatly affect recording time and number of shots values.

Power Consumption	3.7 V DC, Approximately 4.5 W
Dimensions	108.3 (W) × 61.5 (H) × 37.7 (D) mm (4.3" (W) × 2.4" (H) × 1.5" (D)) (28.0 mm (1.1") thick excluding projections)
Weight	Approximately 249 g (8.8 oz) (including battery and memory card) Approximately 209 g (7.4 oz) (excluding battery and memory card)

■ Rechargeable lithium ion battery (NP-130A)

Rated Voltage	3.7 V
Rated Capacitance	1800 mAh
Operating Temperature Requirements	0 to 40°C (32 to 104°F)
Dimensions	37.8 (W) × 44.8 (H) × 11.2 (D) mm (1.49" (W) × 1.76" (H) × 0.44" (D)) (excluding projections)
Weight	Approximately 38 g (1.3 oz)

■ USB-AC adaptor (AD-C53U)

Input	100 to 240 V AC, 50/60 Hz, 100 mA
Output	5.0 V DC, 650 mA
Operating Temperature Requirements	5 to 35°C (41 to 95°F)
Dimensions	53 (W) × 21 (H) × 45 (D) mm (2.1" (W) × 0.83" (H) × 1.8" (D)) (excluding projections)
Weight	Approximately 37 g (1.3 oz)

- Power cord precautions for use in Singapore
The power cord set is not supplied. The power cord used must comply with relevant national and/or international standards.

CASIO®

CASIO COMPUTER CO., LTD.
6-2, Hon-machi 1-chome
Shibuya-ku, Tokyo 151-8543, Japan