

CASIO®

Digital Camera

EX-ZR400

EX-ZR410

User's Guide

E

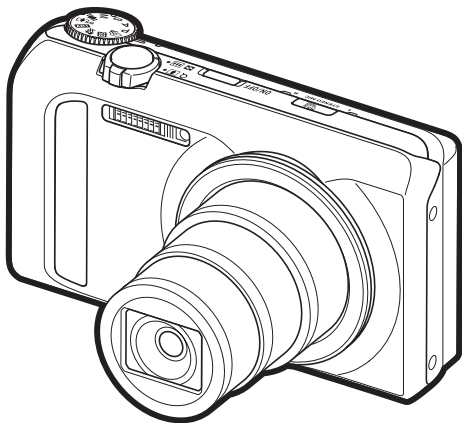

Thank you for purchasing this CASIO product.

- Before using it, be sure to read the precautions contained in this User's Guide.
- Keep the User's Guide in a safe place for future reference.
- For the most up-to-date information about this product, visit the official EXILIM Website at <http://www.exilim.com/>

EXILIM

Accessories

As you unpack your camera, check to make sure that all accessories shown below are included. If anything is missing, contact your original retailer.

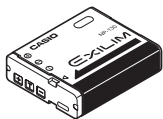

Rechargeable lithium ion battery (NP-130)

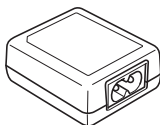

USB-AC adaptor (AD-C53U)



USB cable

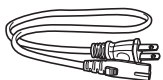

* The shape of the power cord plug varies according to country or geographic area.

Power cord



Strap

To attach the strap to the camera

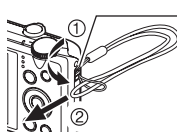

Attach strap here.

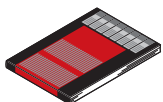

Basic Reference

Read this first!

- The contents of this manual are subject to change without notice.
- The contents of this manual have been checked at each step of the production process. Feel free to contact us if you notice anything that is questionable, erroneous, etc.
- Any copying of the contents of this User's Guide, either in part or its entirety, is forbidden. Except for your own personal use, any other use of the contents of this manual without the permission of CASIO COMPUTER CO., LTD. is forbidden under copyright laws.
- CASIO COMPUTER CO., LTD. shall not be held liable for any damages or lost profits suffered by you or any third party due to the use or malfunction of this product.
- CASIO COMPUTER CO., LTD. shall not be held liable for any damages or lost profits caused by loss of memory contents due to malfunction, repair, or any other reason.
- Note that the example screens and product illustrations shown in this User's Guide may differ somewhat from the screens and configuration of the actual camera.

LCD Panel

The liquid crystal panel of the monitor screen uses high-precision technology that provides a pixel yield in excess of 99.99%. This means that some very small number of pixels may not light or may remain lit at all times. This is due to the characteristics of the liquid crystal panel, and does not indicate malfunction.

Take test shots

Before shooting your final image, shoot a test shot to ensure that the camera is recording correctly.

Contents

Accessories	2
Read this first!	3
General Guide	9
Monitor Screen Contents and How to Change Them	10

Quick Start Basics 14

What you can do with your CASIO camera	14
First, charge the battery prior to use	16
■ To load the battery	16
■ Charge the Battery	17
Configuring Basic Settings the First Time You Turn On the Camera	22
Preparing a Memory Card	23
■ Supported Memory Cards	23
■ To load a memory card	24
■ To format (initialize) a new memory card	25
Turning the Camera On and Off	26
Holding the Camera Correctly	27
To shoot a snapshot	28
■ Selecting an Auto Recording Mode	28
■ To shoot a snapshot	29
Viewing Snapshots	32
Deleting Snapshots and Movies	33
Snapshot Shooting Precautions	34

Snapshot Tutorial 36

Selecting the Recording Mode	36
Using the Control Panel	38
Using the Self-timer	(Self-timer) 39
Adjusting White Balance	(White Balance) 40
Selecting a Focus Mode	(Focus) 42
Specifying ISO Sensitivity	(ISO) 45
Recording Beautiful Portraits	(Make-up Level) 46
Correcting Image Brightness	(EV Shift) 47
Using Flash	(Flash) 48
Specifying the Metering Mode	(Metering) 50
Shooting with Zoom	51
■ Monitor Screen Information when Zooming	52
■ Zooming with Super Resolution	(Zoom (SR)) 54
■ Expanding the Zoom Range to Shoot Clearer Snapshots	(Multi SR Zoom) 55
Shooting a Burst of Images	(High Speed CS) 55
Using Focus Control	59
■ Shooting with a Blurred Background	(Blurred Background) 59
■ Shooting with Full Focus Macro	(All-In-Focus Macro) 60

Shooting with Artistic Effects (ART SHOT)	61
■ Saving a Second Normal Image When Shooting With HDR Art (Double (HDR Art))	63
Shooting with Triple Shot	64

Recording Movies **65**

To record a movie	65
■ Audio	66
Recording a High-definition Movie	68
Recording a High Speed Movie	68
Using Prerecord Movie (Prerecord (Movie))	70
Recording a Movie for YouTube (For YouTube)	72
Shooting a Snapshot while Shooting a Movie (Snapshot In Movie)	73

Using BEST SHOT **74**

To shoot with BEST SHOT	74
Creating and Using Your Own Setups (CUSTOM SHOT)	76
Digitally Correcting for Overexposure and Underexposure (HDR)	77
Shooting Bright Images in the Dark without Flash (High Speed Night Shot)	78
Shooting with a Super Wide Angle of View (Wide Shot)	79
Shooting a Panorama Image (Slide Panorama)	82
Shooting with Priority on Subject Faces (High Speed Best Selection)	84
Configuring the Camera to Help You Better Time Your Shots (Lag Correction)	85
Using Continuous Shutter with Auto Focus (AF-CS)	87
Shooting with High Speed Anti Shake (High Speed Anti Shake)	88
Shooting Snapshots (Snapshot)	89
Using a TV Screen to Shoot Snapshots (HDMI TV Output)	90

Advanced Settings **(REC MENU) 92**

Configuring Recording Settings	92
Assigning Functions to the [◀] and [▶] Keys (L/R Key)	93
Saving a Second Normal Image When Shooting With HDR Art (Double (HDR ART))	94
To select the snapshot image size (Image Size)	94
Specifying Snapshot Image Quality (Image Quality)	96
Movie Image Quality Settings (Movie Quality)	96
Specifying ISO Sensitivity (ISO)	97
Specifying the ISO Sensitivity Upper Limit (ISO High Limit)	98
Zooming with Super Resolution (Zoom (SR))	99
Specifying the Auto Focus Area (AF Area)	99
Reducing the Effects of Camera and Subject Movement (Anti Shake)	100
Optimizing Image Brightness (Lighting)	101

Shooting with Continuous Auto Focus	(Continuous AF) . 102
Shooting with Face Detection	(Face Detection) . 102
Turning Digital Zoom On or Off	(Digital Zoom) . 103
Reducing Wind Noise during Movie Recording	(Wind Noise Cut) . 103
Recording Beautiful Portraits	(Make-up Level) . 103
Correcting Image Brightness	(EV Shift) . 104
Adjusting White Balance	(White Balance) . 104
Selecting a Focus Mode	(Focus) . 104
Using the Self-timer	(Self-timer) . 104
Specifying the Metering Mode	(Metering) . 104
Specifying Flash Intensity	(Flash Intensity) . 105
Controlling Image Sharpness	(Sharpness) . 105
Controlling Color Saturation	(Saturation) . 105
Adjusting Image Contrast	(Contrast) . 105
Using the Auto Focus Assist Light	(AF Assist Light) . 106
Displaying the On-screen Grid	(Grid) . 106
Turning on Image Review	(Review) . 107
Using Icon Help	(Icon Help) . 107
Configuring Power On Default Settings	(Memory) . 108

■ Viewing Snapshots and Movies 109

Viewing Snapshots	109
Viewing a Movie	109
Viewing a Panorama Image	110
Viewing Continuous Shutter Images	111
■ Deleting Continuous Shutter Images	112
■ Dividing Up a CS Group	114
■ Copying a CS Group Image	115
Zooming an On-screen Image	116
Displaying the Image Menu	116
Viewing Snapshots and Movies on a TV Screen	117
■ Viewing High-quality Movies on a Hi-Vision Television	118

■ Other Playback Functions (PLAY MENU) 121

Playing a Slideshow on the Camera	(Slideshow) . 121
■ Transferring Music from Your Computer to Camera Memory	122
Creating a Snapshot of Movie Frames	(MOTION PRINT) . 123
Editing a Movie on the Camera	(Movie Editing) . 124
Optimizing Image Brightness	(Lighting) . 125
Adjusting White Balance	(White Balance) . 126
Adjusting the Brightness of an Existing Snapshot	(Brightness) . 126
Selecting Images for Printing	(DPOF Printing) . 127
Protecting a File Against Deletion	(Protect) . 127
Editing the Date and Time of an Image	(Date/Time) . 129

Rotating an Image	(Rotation) .	129
Resizing a Snapshot	(Resize) .	130
Cropping a Snapshot	(Trimming) .	130
Copying Files	(Copy) .	131
Dividing Up a Continuous Shutter Group	(Divide Group) .	131
Combining CS Images into a Single Still Image	(CS Multi Print) .	132
Editing a CS Image	(CS Frame Edit) .	132

■ Printing 133

Printing Snapshots	133
Connecting Directly to a PictBridge Compatible Printer	133
Using DPOF to Specify Images to be Printed and the Number of Copies	(DPOF Printing) . 135

■ Using the Camera with a Computer 140

Things you can do using a computer... ..	140
Using the Camera with a Windows Computer	141
■ Viewing and Storing Images on a Computer	141
■ Playing Movies	144
Using the Camera with a Macintosh	145
■ Connecting the Camera to Your Computer and Saving Files	145
■ Playing a Movie	147
Using an SD Memory Card with Built-in LAN	148
■ Transferring Images with an Eye-Fi Card	(Eye-Fi) . 148
■ Using a Smartphone to Play Back Images Stored on a FlashAir Card	(FlashAir) . 150
Files and Folders	152
Memory Card Data	153

■ Other Settings (SETTING) 155

Enabling Power Saving	(ECO Mode) .	155
Adjusting Monitor Screen Brightness	(Screen) .	155
Turning off Eye-Fi Card Communication	(Eye-Fi) .	156
Configuring FlashAir Card Communication Settings	(FlashAir) .	156
Configuring Camera Sound Settings	(Sounds) .	156
Creating an Image Storage Folder	(Create Folder) .	157
Time Stamping Snapshots	(Timestamp) .	157
Auto Image Orientation Detection and Rotation	(Auto Rotate) .	158
Specifying the File Name Serial Number Generation Rule	(File No.) .	158
Configuring Sleep State Settings	(Sleep) .	159
Configuring Auto Power Off Settings	(Auto Power Off) .	159
Configuring [📷] Setting	(REC) .	160
Configuring [▶] Setting	(PLAY) .	160
Disabling File Deletion	(Delete Key) .	160

Configuring World Time Settings (World Time) .	161
Setting the Camera's Clock (Adjust) .	162
Specifying the Date Style (Date Style) .	162
Specifying the Display Language (Language) .	163
Configuring USB Protocol Settings (USB) .	163
Selecting the Screen Aspect Ratio and Video Output System (Video Out) .	164
Selecting the HDMI Terminal Output Method (HDMI Output) .	164
Formatting Built-in Memory or a Memory Card (Format) .	165
Resetting the Camera to Factory Defaults (Reset) .	165

Appendix **166**

Safety Precautions	166
Precautions During Use	173
Power Supply	176
■ Charging	176
■ Battery Precautions	177
■ Using the Camera in another Country	177
Using a Memory Card	178
Reset Initial Default Settings	180
Using the On-screen Histogram to Check Exposure (+Histogram) .	182
When things don't go right...	184
■ Troubleshooting	184
■ Display Messages	189
Number of Snapshots/Movie Recording Time	191
Specifications	195

General Guide

The numbers in parentheses indicate the pages where each item is explained.

Front

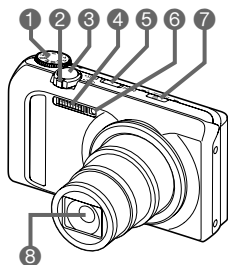

- 1 Mode dial (pages 28, 36, 65)
- 2 Zoom controller (pages 29, 51, 116)
- 3 Shutter button (pages 26, 28)
- 4 Flash (page 48)
- 5 [ON/OFF] (Power) (pages 22, 26)
- 6 Front lamp (pages 39, 106)
- 7 [] (Continuous Shutter) (page 55)
- 8 Lens

Back

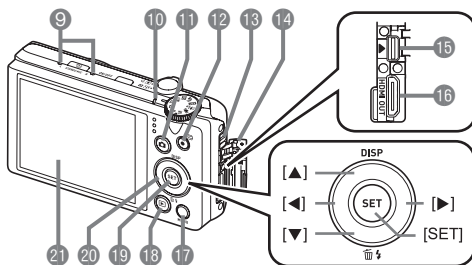

- 9 Microphones (page 66)
- 10 Back lamp (pages 18, 19, 26, 29, 48)
- 11 [] (REC) button (page 26)
- 12 [] (Movie) button (page 65)
- 13 Strap hole (page 2)
- 14 Terminal cover
- 15 [USB/AV] port (pages 17, 18)
- 16 [HDMI OUT] HDMI output (Mini) (page 118)
- 17 [MENU] button (pages 65, 92)
- 18 [] (PLAY) button (pages 26, 32)
- 19 [SET] button (pages 38, 65, 92)
- 20 Control button ([▲] [▼] [◀] [▶]) (pages 38, 65, 74, 92)
- 21 Monitor screen (pages 10, 26)

Bottom

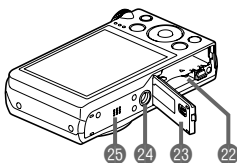

- 22 Battery/memory card slots (pages 16, 24)
- 23 Battery cover
- 24 Tripod hole
Use this hole when attaching to a tripod.
- 25 Speaker

Monitor Screen Contents and How to Change Them

The monitor screen uses various indicators, icons, and values to keep you informed of the camera's status.

- The sample screens in this section are intended to show you the locations of all the indicators and figures that can appear on the monitor screen in various modes. They do not represent screens that actually appear on the camera.

■ Snapshot Recording (1 Shot)

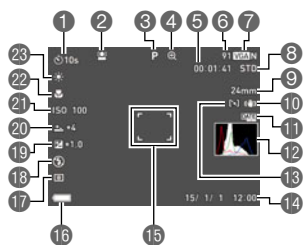

- 1 Self-timer mode (page 39)
- 2 Face Detection (page 102)
- 3 Recording mode (page 28)
- 4 Image deterioration indicator/
Zoom (SR) indicator (page 53)
- 5 Remaining movie memory
capacity (page 65)
- 6 Remaining snapshot memory capacity
(page 191)
- 7 Snapshot image size/Quality (pages 94, 96)
- 8 Movie quality (FHD/STD movie)
(pages 65, 68)/
Recording speed (high speed movie) (page 68)
- 9 Focal distance
(Converted to 35 mm film format.) (page 52)
- 10 Anti Shake (page 100)
- 11 Timestamp indicator (page 157)
- 12 Histogram (page 182)
- 13 AF Area (page 99)
- 14 Date/Time (pages 22, 162)
- 15 Focus frame (pages 29, 99)
- 16 Battery level indicator (page 21)
- 17 Metering mode (page 104)
- 18 Flash (page 48)
- 19 Exposure compensation (page 47)
- 20 Make-up level (page 46)
- 21 ISO sensitivity (page 45)
- 22 Focus mode (page 42)
- 23 White balance (page 40)

NOTE

- The semi-transparent gray frame on the monitor screen indicates the area that is recorded when shooting a movie. The area within the frame is recorded for a movie.
- Depending on recording settings, the aperture, shutter speed, and ISO sensitivity values may not appear on the monitor screen. These values will be red if the Auto Exposure (AE) is not correct for some reason.

■ Snapshot Recording (Burst Shooting)

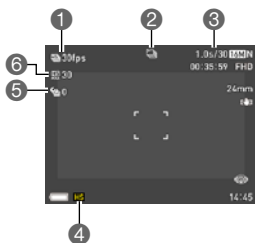

- 1 Continuous Shutter (CS) speed (page 56)
- 2 Recording mode (page 28)
- 3 Allowable CS time/number of CS images (page 56)
- 4 Continuous Shutter mode (page 55)
- 5 Prerecord CS shots (page 57)
- 6 Maximum CS shots (page 56)

■ Movie Recording

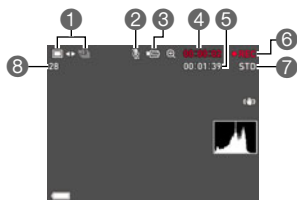

- 1 Snapshot recording mode (Snapshot In Movie) (page 73)
- 2 Audio recording disabled (page 68)
- 3 Recording mode (page 65)
- 4 Movie recording time (page 65)
- 5 Remaining movie memory capacity (page 65)
- 6 Movie recording in progress (page 65)
- 7 Movie quality (FHD/STD movie) (pages 65, 68)/
Recording speed (high speed movie) (page 68)
- 8 Remaining snapshot memory capacity (page 191)

■ Snapshot Viewing

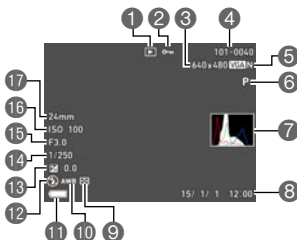

- 1 File type
- 2 Protect indicator (page 127)
- 3 Snapshot image size (page 94)
- 4 Folder name/file name (page 152)
- 5 Snapshot image quality (page 96)
- 6 Recording mode (page 28)
- 7 Histogram (page 182)
- 8 Date/time (page 162)
- 9 Metering mode (page 104)
- 10 White balance (page 126)
- 11 Battery level indicator (page 21)
- 12 Flash (page 48)
- 13 Exposure compensation (page 47)
- 14 Shutter speed
- 15 Aperture value
- 16 ISO sensitivity (page 45)
- 17 Focal distance
(Converted to 35 mm film format.)

■ CS Image Viewing

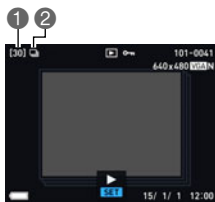

- 1 Number of images in the group (page 111)
- 2 CS group icon (page 111)

■ Movie Playback

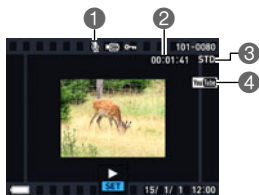

- 1 No audio data available
- 2 Movie recording time (page 109)
- 3 Recording mode/Movie quality/speed (pages 65, 68, 68)
- 4 YouTube (page 72)

■ Configuring Monitor Screen Settings

Each press of [▲] (DISP) will cycle through display settings that display or hide on-screen information. You can configure separate settings for the REC mode and PLAY mode.

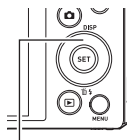

[▲] (DISP)

REC mode

Information on	Displays setting information.
Information on, histogram on	Displays setting information and a histogram (page 182) on the right side of the display.
Information off	Hides setting information.



PLAY mode

Information display on	Displays settings when shooting, current date and time, and other information.
Information on, histogram on	Displays settings when shooting, current date and time, histogram (page 182), and other information.
Information display off	No information displayed when shooting.

What you can do with your CASIO camera

Your CASIO camera is packed with a powerful selection of features and functions to make recording of digital images easier, including the following main functions.



ART SHOT

A variety of artistic effects help to make even common, ordinary subjects become more novel and exciting. "ART SHOT" provides the following effects: HDR Art, Toy Camera, Soft Focus, Light Tone, Pop, Sepia, Monochrome, Miniature, Fisheye.

→ See page **61** for more information.



High Speed Night Shot

The camera shoots a series of images and then merges them into a final image. The result is a bright image, even if shot in the dark without a flash.

→ See page **78** for more information.



Premium Auto PRO

Select Premium Auto PRO recording and the camera automatically determines whether you are shooting a subject or scenery, and other conditions. Premium Auto PRO delivers higher image quality than standard Auto.

→ See page **28** for more information.

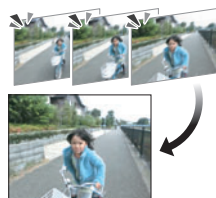

Triple Shot

Pressing the shutter button shoots a burst of three images and stores them in memory. This feature is great for making sure you don't miss those special moments when kids are around.

→ See page **64** for more information.



Blurred Background/All-In-Focus Macro (Focus Control)

Focus Control shoots and analyzes a burst of multiple images and combines them in a way that produces either image in which the background is blurred or everything is in focus: from nearby objects to distant objects.

→ See page **59** for more information.



Wide Shot

With this feature, a number of images are shot and then combined to produce an image with a super-wide angle of view that exceeds the widest angle of view possible with the lens. Converted to 35 mm equivalents, the focal distances available with this feature enable shooting with approximate angles of view of 14 mm and 18 mm.

→ See page **79** for more information.

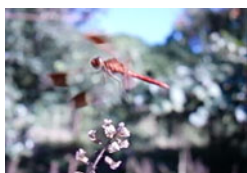

High Speed Movie

Movies can be recorded at up to 1000 frames per second. This makes it possible to clearly view phenomena that are invisible to the human eye, in slow motion.

→ See page **68** for more information.

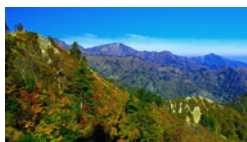

FHD Movie Recording

You can record movies in high-quality FHD. (1920×1080 pixels 30 fps)

→ See page **68** for more information.

First, charge the battery prior to use.

Note that the battery of a newly purchased camera is not charged. Perform the steps below to load the battery into the camera and charge it.

- Your camera requires a special CASIO rechargeable lithium ion battery (NP-130) for power. Never try to use any other type of battery.

To load the battery

1. Open the battery cover.

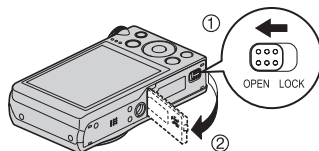

2. Load the battery.

With the EXILIM logo on the battery facing downwards (in the direction of the lens), hold the stopper next to the battery in the direction indicated by the arrow as you slide the battery into the camera. Press the battery in until the stopper secures it in place.

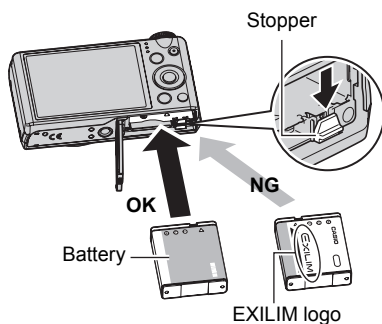

3. Close the battery cover.

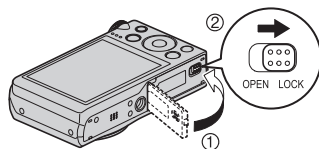

To replace the battery

1. Open the battery cover and remove the current battery.

2. Load a new battery.

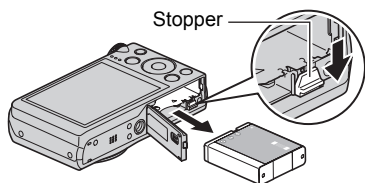

Charge the Battery

You can use either of the two following methods to charge the camera's battery.

- USB-AC adaptor
- USB connection to a computer

■ To charge with the USB-AC adaptor

The adaptor lets you charge the battery while it is loaded in the camera.

While the camera is turned off, connect in the sequence shown below (①, ②, ③, ④).

Charging time: Approximately 240 minutes

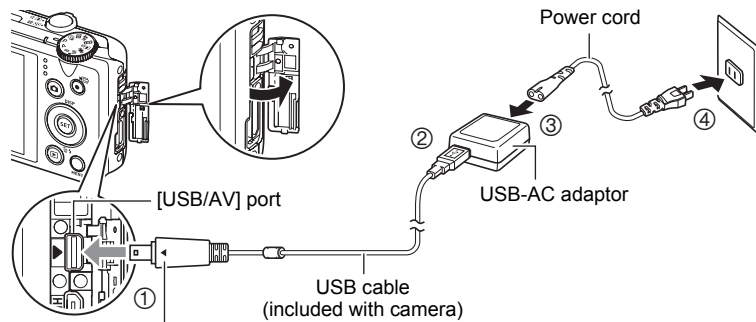

Making sure that the ► mark on the camera is aligned with the ◀ mark of the USB cable connector, connect the cable to the camera.

★ IMPORTANT!

- A battery that has not been used for a long time, or ambient temperature extremes can cause charging to take longer than normal. If charging takes longer than about six hours, a timer will terminate it automatically, even if the battery is not fully charged. This is indicated by the back lamp flashing red. If the battery has not been used for a very long time, charging may be terminated automatically and the back lamp may start flashing red after only about 45 minutes. In either case, disconnect the USB cable from the camera and then reconnect it to resume charging.
- Make sure that you insert the cable connector into the [USB/AV] port until you feel it click securely into place. Failure to insert the connector fully can result in poor communication or malfunction.
- Note that even while the connector is fully inserted, you still will be able to see the metal part of the connector as shown in the illustration.

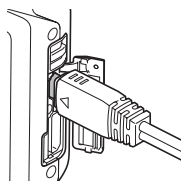

Back Lamp Operation

Lamp Status	Description
Lit Red	Charging
Flashing Red	Abnormal ambient temperature, USB-AC adaptor problem, or battery problem (page 176)
Off	Charging complete

Back lamp

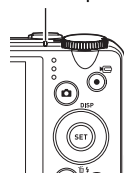

■ To charge using a USB connection to a computer

USB connection lets you charge the battery while it is loaded in the camera. While the camera is turned off, connect in the sequence shown below (①, ②).

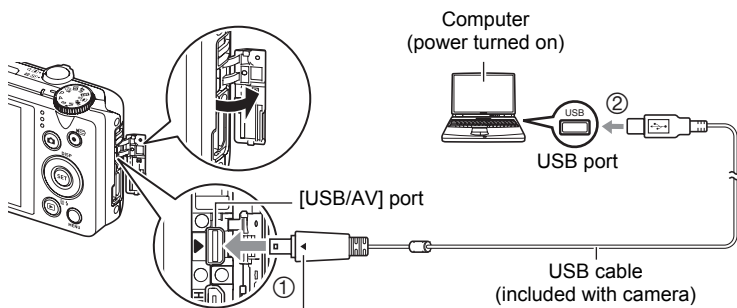

Making sure that the ► mark on the camera is aligned with the ◄ mark of the USB cable connector, connect the cable to the camera.

- If the camera is on, press [ON/OFF] (Power) to turn it off before connecting it to your computer.



IMPORTANT!

- The first time you connect the camera to your computer with the USB cable, an error message may appear on your computer. If this happens, disconnect and then reconnect the USB cable.
- A battery that has not been used for a long time, certain types of computers, and connection conditions can cause charging to take more than approximately six hours, which will trigger a timer that terminates charging automatically, even if the battery is not fully charged. If this happens, disconnect and then reconnect the USB cable to restart charging. To complete charging faster, use of the included USB-AC adaptor is recommended.
- If the battery has not been used for a very long time, charging may terminate automatically and the back lamp may start flashing red or go out after only about 45 minutes. In either case, use of the USB-AC adaptor that comes with the camera is recommended.
- If you turn on the camera while charging over a USB connection to a computer is in progress, the camera will establish a USB connection with the computer. Though charging normally should continue at this time, certain types of computers or connection environments may stop charging if supply power is low. This will be indicated by the camera's back lamp lighting green.
- Charging is not performed while the connected computer is in the hibernate mode.

Back Lamp Operation

Lamp Status	Description
Lit Red, (Lit/Flashing Amber)	Charging
Flashing Red	Abnormal ambient temperature, charging taking abnormally long, or battery problem (page 176)
Off, (Lit Green)	Charging complete

Back lamp

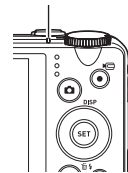





- The information in parentheses in the above table shows the lamp status while the camera is turned on during charging.

Other Charging Precautions

- With the two charging methods described above, you can charge the camera's battery (NP-130) without removing it from the camera. You also can charge the battery using an optionally available charger unit (BC-130L). Never use any other type of charger device. Attempting to use a different charger can result in unexpected accident.
- This model can be charged only via from USB 2.0 specification USB port only.
- USB charging devices and power supply devices are subject to fixed standards. Use of an inferior device or a device that is not up to standard can cause malfunction and/or failure of your camera.
- Operation is not guaranteed in the case of a computer built or modified by you. Even in the case of a commercially available computer, certain USB port specifications may make it impossible to charge via the USB cable.
- A battery that is still warm immediately after normal use may not charge fully. Give the battery time to cool before charging it.
- A battery discharges slightly even when it is not loaded in the camera. Because of this, it is recommended that you charge the battery immediately before you need to use it.
- Charging the camera's battery may cause interference with TV and radio reception. If this happens, plug the USB-AC adaptor into an outlet that is further away from the TV or radio.
- Actual charging time depends on current battery capacity and charging conditions.
- Do not use the USB-AC adaptor with any other device.
- Never use the power cord with another device.

Checking Remaining Battery Power

As battery power is consumed, a battery indicator on the monitor screen indicates remaining power as shown below.

Remaining Power	High ←————→ Low
Battery Indicator	 →  →  → 
Indicator Color	White → White → Red → Red

 indicates battery power is low. Charge the battery as soon as possible.

Recording is not possible when  is indicated. Charge the battery immediately.

- The level shown by the battery indicator may change when you switch between the REC mode and PLAY mode.
- Leaving the camera for about 30 days with no power supplied while the battery is dead will cause its date and time settings to be cleared. A message telling you to configure time and date settings will appear the next time you turn on the camera after restoring power. When this happens, configure date and time settings (page 162).
- See page 197 for information about battery life and number of shots.

Battery Power Conservation Tips

- Entering the “ECO Mode” enables low-power operation (page 155).
- When you do not need to use the flash, select  (Flash Off) for the flash setting (page 48).
- Enable the Auto Power Off and the Sleep features to protect against wasting battery power when you forget to turn off the camera (pages 159, 159).
- Select “Off” for “Continuous AF” (page 102).

Configuring Basic Settings the First Time You Turn On the Camera

The first time you load a battery into the camera, a screen appears for configuring the display language, date, and time settings. Failure to set the date and time correctly will cause the wrong date and time data to be recorded with images.

IMPORTANT!

- A screen for language selection will not appear in step 2 of the procedure below if you purchased a camera intended for the Japanese market. To change the display language from Japanese in this case, use the procedure under “Specifying the Display Language (Language)” (page 163). Note that a version of this manual in the language you select may not be included with a camera intended for the Japanese market.
- Camera models sold in certain geographic areas may not support display language selection.

1. Press [ON/OFF] (Power) to turn on the camera.

2. Use [▲], [▼], [◀], and [▶] to select the language you want and then press [SET].

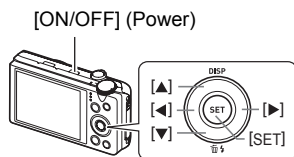

3. Use [▲] and [▼] to select a date style and then press [SET].

Example: July 10, 2015

YY/MM/DD → 15/7/10

DD/MM/YY → 10/7/15

MM/DD/YY → 7/10/15

4. Set the date and the time.

Use [◀] and [▶] to select the setting you want to change and then use [▲] and [▼] to change it. To switch between 12-hour and 24-hour format, select “24h” and then use [▲] and [▼] to change the setting.

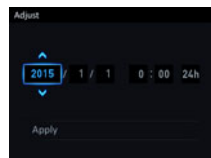

5. After setting the date and time, use [◀] and [▶] to select “Apply” and then press [SET].

If you make a mistake configuring display language, date, or time settings with the above procedure, refer to the following pages for information about how to correct the settings.

- Display language: page 163
- Date and time: page 162

NOTE

- Each country controls its local time offset and the use of summer time, and so they are subject to change.
- Removing the battery from the camera too soon after configuring time and date settings for the first time can cause the settings to be reset to their factory defaults. Do not remove the battery for at least 24 hours after configuring settings.

Preparing a Memory Card

Though the camera has built-in memory that can be used to store images and movies, you probably will want to purchase a commercially available memory card for greater capacity. The camera does not come with a memory card. Images recorded while a memory card is loaded are saved to the memory card. When no memory card is loaded, images are saved to built-in memory.

- For information about memory card capacities, see page 191.

Supported Memory Cards

- SD Memory Card
- SDHC Memory Card
- SDXC Memory Card



Use one of the above types of memory card.

- The above are supported memory card types as of December 2012.
- This camera supports use of SD memory cards of the following types and capacities: SD memory cards up to 2GB, SDHC memory cards from 2GB up to 32GB, SDXC memory cards from 32GB up to 2TB. Note that the ability to use any particular card with this camera, even if it satisfies the above capacity and type requirements, is not guaranteed.
- This camera supports use of Eye-Fi cards and FlashAir cards.

Memory Card Handling Precautions

Certain types of cards can slow down processing speeds, and even can make it impossible to store High Quality movies correctly. Also, use of certain types of memory cards slows down data transfer and increases the time it takes to record movie data, which can result in movie frames being dropped. The **REC** indicator on the monitor screen turns yellow to indicate that frames are being dropped. In order to avoid problems such as these, use of an Ultra High Speed Type SD memory card is recommended. Note, however that CASIO makes no guarantees about the operation of any Ultra High Speed Type SD memory card used with this camera.

To load a memory card

1. Press [ON/OFF] (Power) to turn off the camera and then open the battery cover.

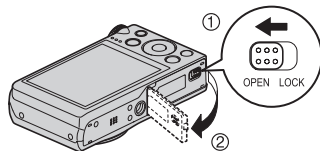

2. Load a memory card.

Positioning the memory card so its front is facing upwards (towards the monitor screen side of the camera), slide it into the card slot all the way in until you hear it click securely into place.

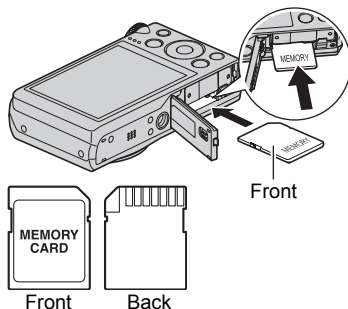

3. Close the battery cover.

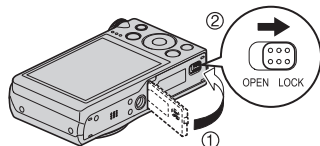

IMPORTANT!

- Never insert anything besides a supported memory card (page 23) into the memory card slot.
- Should water or any foreign object ever get into the card slot, immediately turn off the camera, remove the battery, and contact your retailer or nearest CASIO authorized service center.

To replace the memory card

Press the memory card and then release it. This will cause it to pop out of the memory card slot slightly. Pull the card out the rest of the way and then insert another one.

- Never remove a card from the camera while the back lamp is flashing green. Doing so can cause the image save operation to fail and even damage the memory card.

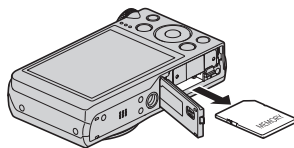

To format (initialize) a new memory card

Format a memory card on the camera before using it for the first time.

IMPORTANT!

- Formatting a memory card that already has snapshots or other files on it, will delete its contents. Normally you do not need to format a memory card again. However, if storing to a card has slowed down or if you notice any other abnormality, re-format the card.
- Be sure to use the camera to format a memory card. Formatting a card on a computer will result in a non-SD standard format, which can greatly slow down processing time and cause compatibility, performance, and other problems.
- Before formatting a new Eye-Fi card to use it for the first time, copy the Eye-Fi Center install files to your computer. Do this before formatting the card.
- Formatting a FlashAir card with the camera will delete files on the card that are required for communication. For details about formatting, see the instructions that come with the FlashAir card.

- 1. Turn on the camera and press [MENU].**

- 2. Press [◀], use [▲] and [▼] to select the “⚙️ SETTING” tab, and then press [▶].**

- 3. Use [▲] and [▼] to select “Format” and then press [SET].**

- 4. Use [▲] and [▼] to select “Format” and then press [SET].**

- 5. Use [▲] and [▼] to select “Yes” and then press [SET].**

Turning the Camera On and Off

■ To turn power on

Pressing [ON/OFF] (Power) enters the REC mode so you can record images. Pressing [▶] (PLAY) while in the REC mode enters the PLAY mode, which you can use to view snapshots and movies (pages 32, 109).

- You also can turn on the camera by pressing [▶] (PLAY).
- Pressing [📷] (REC) or the shutter button while in the PLAY mode returns to the REC mode.
- Take care to ensure that nothing is restricting or coming into contact with the lens as it extends. Holding the lens with your hand so it cannot extend creates the risk of malfunction.
- About 10 seconds after you press [▶] (PLAY) to enter the PLAY mode, the lens will retract into the camera.
- The Sleep function or Auto Power Off (pages 159, 159) will turn off power automatically if you do not perform any operation for a preset amount of time.

[ON/OFF] (Power)

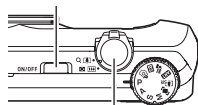

Shutter button

Back lamp

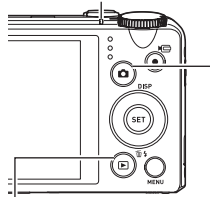

[▶] (PLAY)

[📷] (REC)

■ To turn off the camera

Press [ON/OFF] (Power).

NOTE

- You also can configure the camera to turn on or off when you press [📷] (REC) (page 160).
- The camera can be configured so power turns off when [▶] (PLAY) is pressed (page 160).

Holding the Camera Correctly

Your images will not come out clearly if you move the camera when you press the shutter button. When pressing the shutter button, be sure to hold the camera as shown in the illustration, and keep it still by pressing your arms firmly against your sides as you shoot. Holding the camera still, carefully press the shutter button and take care to avoid all movement as the shutter releases and for a few moments after it releases. This is especially important when available lighting is low, which slows down the shutter speed.

Horizontal

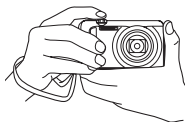

Vertical

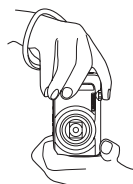

Hold the camera so the flash is above the lens.

NOTE

- Take care that your fingers and the strap do not cover any of the areas indicated in the illustration.
- To protect against accidentally dropping the camera, attach the wrist strap and make sure it is around your fingers or wrist while you are operating the camera.
- Never swing the camera around by its strap.
- The supplied strap is intended for use with this camera only. Never use it for any other purpose.
- When the “Auto Rotate” setting is turned on, the camera will detect whether it is being held vertically or horizontally when a snapshot image is shot. When you display an image shot with the camera held vertically, the image is rotated automatically 90 degrees when displayed on the monitor screen (page 158).

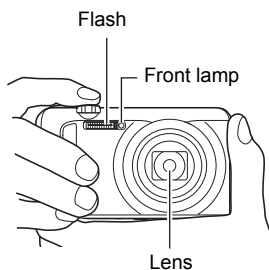

IMPORTANT!

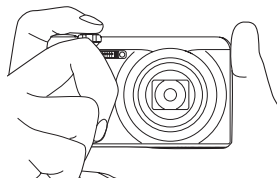

- Take care to ensure that your fingers are not blocking or are not too close to the flash. Fingers can cause unwanted shadows when using the flash.



To shoot a snapshot

Selecting an Auto Recording Mode

You can select one of two auto recording modes (Program Auto or Premium Auto PRO) according to your digital imaging needs.

Setting	REC Screen Icon Display	Description
P Program Auto		This is the standard Auto recording mode.
 Premium Auto PRO		With Premium Auto PRO recording, the camera automatically determines whether you are shooting a subject or scenery, and other conditions. Premium Auto PRO recording delivers higher image quality than Program Auto recording. <ul style="list-style-type: none">• It also requires more power (and runs down the battery quicker) than Program Auto.

1. Press [ON/OFF] (Power) to turn on the camera.

The camera will enter the REC mode.

- If the camera is in the PLAY mode, press the shutter button.

2. Align the mode dial with [P] (Program Auto) or [] (Premium Auto PRO) to select Auto recording mode.

Remaining Snapshot Memory Capacity (page 191)

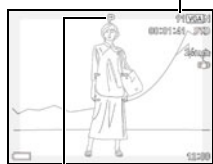

Auto recording mode icon

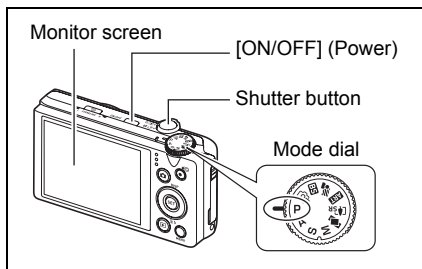

To shoot a snapshot

1. Point the camera at the subject.

If you are shooting with Premium Auto PRO, text will appear at the bottom of the monitor screen describing the type of shot the camera has detected.

- You can zoom the image, if you want.

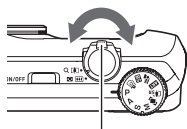

Zoom controller



Wide Angle



Telephoto

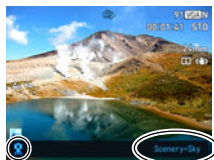

Appears when the camera detects it is stationary on a tripod.



If the camera decides that it needs to shoot a series of images with Continuous Shutter (CS), it will display "CS". Take care to avoid any camera and subject movement until shooting of all of the CS images is complete.

2. Half-press the shutter button to focus the image.

When focus is complete, the camera will beep, the back lamp will light green, and the focus frame will turn green.

Back lamp

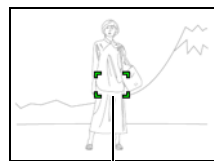

Focus frame

Half-press

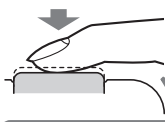

Press lightly until the button stops.

Beep, beep (Image is in focus.)

When you half-press the shutter button, the camera automatically adjusts exposure and focuses on the subject it is currently pointed at. Mastering how much pressure is required for a half-press and a full-press of the shutter button is an important technique for good-looking images.

3. Continuing to keep the camera still, press the shutter button the rest of the way down.

This records the snapshot.

Full-press

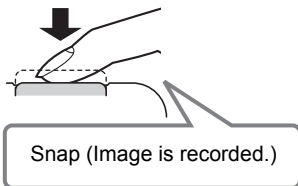

Recording a Movie

Press **[●]** (Movie) to start movie recording. Press **[●]** (Movie) again to stop movie recording. See the following pages for details.

Standard movie (STD movie): page 65

High-definition movie (FHD movie): page 68

High speed movie (HS movie): page 68

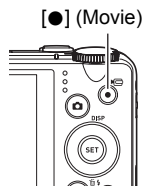

■ If the image does not focus...

If the focus frame stays red and the back lamp is flashing green, it means that the image is not in focus (because the subject is too close, etc.). Re-point the camera at the subject and try to focus again.

■ Shooting with Auto

If the subject is not in the center of the frame...

"Focus lock" (page 44) is the name of a technique you can use when you want to shoot an image in which the subject to be focused on is not within the focus frame in the center of the screen.

To track the movement of a moving subject

Half-press the shutter button to follow and focus automatically on a moving subject. See **[📷]** "Tracking" (page 99) for more information.

■ Shooting with Premium Auto PRO

- In addition to shutter speed, aperture, and ISO sensitivity, the camera automatically executes the following operation as required when shooting with Premium Auto PRO.
 - Continuous AF (page 102)
 - Intelligent AF (page 99)
 - Face Detection (page 102)
- Shooting with Premium Auto PRO can cause vibration and noise to occur due to lens operation. This does not indicate malfunction.
- When Shooting with Premium Auto PRO, the message “Processing Premium Auto.” may appear on the monitor screen. If you feel the camera is taking too long to process data, try shooting with standard Auto instead.
- In some cases, Premium Auto PRO may not be able to interpret the shooting environment correctly. If this happens, shoot with standard Auto.
- If “[HS]” is displayed, the camera will shoot a series of CS images and merge them into a final image. Take care to avoid any camera and subject movement until shooting of all of the CS images is complete. If you do not want to shoot CS images, select “Off” for the Control Panel (page 38) “HS Scene Shooting” item.
- Certain flash settings (page 48) can limit environmental factors detectable by Premium Auto PRO.

Viewing Snapshots

Use the following procedure to view snapshots on the camera's monitor screen.

- For information about how to play back movies, see page 109.
- For information about images recorded using continuous shutter (CS), see page 111.

1. Turn on the camera and press **[▶] (PLAY)** to enter the **PLAY mode**.

- This will display one of the snapshots currently stored in memory.
- Information about the displayed snapshot also is included (page 11).
- You also can clear the information to view only the snapshot (page 13).
- You can zoom in on the image by rotating the zoom controller towards **[▲]** (page 116). If you are recording a snapshot that is very important to you, it is recommended that you zoom the image and check its details after recording it.

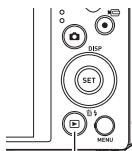

2. Use **[◀]** and **[▶]** to scroll between images.

- Holding down either button scrolls at high speed.



NOTE

- Half-pressing the shutter button while in the PLAY mode or while a menu screen is displayed will switch directly to the REC mode.

Deleting Snapshots and Movies

If memory becomes full, you can delete snapshots and movies you no longer need in order to free up storage and record more images.



IMPORTANT!

- Remember that a file (image) delete operation cannot be undone.
- For information about images recorded using continuous shutter (CS), see page 112.
- If you select “Disabled” for the “Delete Key” setting on the “⚙️ SETTING” menu (page 160), the delete menu will not appear when you press [▼] (🗑️ ⚡) (Delete). You can delete files only while “Enabled” is selected for “Delete Key”.

■ To delete a single file

1. Press [▶] (PLAY) to enter the PLAY mode and then press [▼] (🗑️ ⚡).

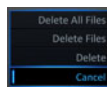

2. Use [◀] and [▶] to scroll through the files until the one you want to delete is displayed.

3. Use [▲] and [▼] to select “Delete” and then press [SET].

- To delete other files, repeat steps 2 and 3.
- To exit the delete operation, press [MENU].
- If a CS group (page 111) is displayed when you perform the above procedure, all of the images in the currently displayed CS group will be deleted.

■ To delete specific files

1. Press [▶] (PLAY) to enter the PLAY mode and then press [▼] (🗑️ ⚡).

2. Use [▲] and [▼] to select “Delete Files” and then press [SET].

- This displays a file selection screen.

3. Use [▲], [▼], [◀], and [▶] to move the selection boundary to the file you want to delete, and then press [SET].

- This will select the check box in the lower left corner of the selected file’s image and move the blue boundary to the next image.
- You can enlarge the selected image before deleting it by rotating the zoom controller towards [⬆] (🔍).

4. Repeat step 3 to select other files, if you want. After you are finished selecting files, press [MENU].

5. Use [▲] and [▼] to select “Yes” and then press [SET].

- This deletes the files you selected.
- To cancel the delete operation, select “No” in step 5 and then press [SET].

■ To delete all files

1. Press [▶] (PLAY) to enter the PLAY mode and then press [▼] (🗑️).
2. Use [▲] and [▼] to select “Delete All Files” and then press [SET].
3. Use [▲] and [▼] to select “Yes” and then press [SET] to delete all files.
This will cause the message “There are no files.” to appear.

Snapshot Shooting Precautions

Operation

- Never open the battery cover while the back lamp is flashing green. Doing so can result in the image you just shot being saved incorrectly, damage to other images stored in memory, malfunction of the camera, etc.
- If unwanted light is shining onto the lens, shade the lens with your hand when shooting an image.

Monitor Screen when Shooting Snapshots

- Subject brightness conditions can cause monitor screen response to slow and can cause digital noise in the monitor screen image.
- The image that appears on the monitor screen is for image composition. The actual image will be recorded at the quality set for the image quality setting (page 96).

Shooting Indoors under Fluorescent Lighting

- Minute flickering of fluorescent lighting can affect the brightness or color of an image.

Other Precautions

- The slower the shutter speed, the greater the possibility that noticeable noise will be generated in an image. Because of this, the camera automatically performs a noise reduction at slow shutter speeds. The noise reduction process causes it to take longer to record images at lower shutter speeds. The shutter speeds for which noise reduction is performed depend on the camera setup and shooting conditions.
- A noise reduction process is performed when ISO sensitivity is set to a high value. This can cause the camera to take relatively longer to be ready to shoot again after you press the shutter button. Do not perform any key operation while the image recording operation is in progress.
- Due to the characteristics of the imaging element used by the camera, very fast moving objects in an image may appear distorted.

■ Auto Focus Restrictions

- Any of the following can make proper focus impossible.
 - Solid color wall or other very low contrast subject
 - Strongly back lit subject
 - Very shiny subject
 - Blinds or other subject with a repeating horizontal pattern
 - Multiple subjects at varying distances from the camera
 - Subject in a dark location
 - Subject that is too far away for light from the AF assist light to reach
 - Camera movement while shooting
 - Fast-moving subject
 - Subjects outside the focus range of the camera
- If you cannot focus properly, try using focus lock (page 44) or Manual Focus (page 42).

Selecting the Recording Mode

Your camera has a variety of different recording modes. Before recording an image, rotate the mode dial to select the recording mode that suits the type of image you are trying to record.

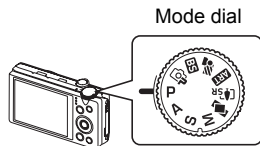

P Program Auto

Standard Auto recording mode. This is the mode you normally should use (page 28).

📷 Premium Auto PRO

With Premium Auto PRO recording, the camera automatically determines whether you are shooting a subject or scenery, and other conditions. Premium Auto PRO recording delivers higher image quality than standard Auto recording (page 28).

BS BEST SHOT

Simply select one of a collection of built-in sample scenes and the camera sets up automatically for beautiful images every time (page 74).

👁️ Focus Control

You can use Focus Control to configure the camera so the background is blurred and only the foreground subject is in focus (Blurred Background), or so everything is in focus (All-In-Focus Macro) (page 59).

ART ART SHOT

A variety of artistic effects help to make even common, ordinary subjects become more novel and exciting.

📷 SR Multi SR Zoom

This feature uses super resolution technology and multiple Continuous Shutter (CS) images to expand the zoom range for overall images of higher quality and clarity (page 55).

📷 Triple Shot

Shoots a burst of three images, making this feature is great for capturing all those special moments when kids are around (page 64).

M M (Manual Exposure) mode

This mode gives you total control over aperture and shutter speed settings.

- ① Press [SET] to open the Control Panel.
- ② Use [▲] and [▼] to select **A** (aperture).
- ③ Use [◀] and [▶] to change the aperture setting.
- ④ Use [▲] and [▼] to select **S** (shutter speed).
- ⑤ Use [◀] and [▶] to change the shutter speed setting, and then press [SET].

S S (Shutter Speed Priority) mode

In this mode, you select the shutter speed and other settings are adjusted accordingly.

- ① Press [SET] to open the Control Panel.
 - ② Use [▲] and [▼] to select **S** (shutter speed).
 - ③ Use [◀] and [▶] to change the shutter speed setting, and then press [SET].
- You also can select the EV shift setting located under the shutter speed setting and then specify an exposure value (EV shift), if you want.

A A (Aperture Priority) mode

In this mode, you select the aperture and other settings are adjusted accordingly.

- ① Press [SET] to open the Control Panel.
 - ② Use [▲] and [▼] to select **A** (aperture).
 - ③ Use [◀] and [▶] to change the aperture setting, and then press [SET].
- You also can select the EV shift setting located under the aperture setting and then specify an exposure value (EV shift), if you want.



IMPORTANT!

- In the S mode, ISO sensitivity (page 45) always operates according to its “Auto” setting. The ISO sensitivity setting cannot be changed while in the S mode.
- The flash **⚡A** (Auto Flash) and **👁** (Red Eye Reduction) flash modes are not supported while A, S, or M is selected for the recording mode. If you want the flash to fire, select **⚡** (Flash On) as the flash mode.
- The displayed ISO sensitivity, shutter speed or aperture value will turn red when you half-press the shutter button if the image is overexposed or underexposed.

Using the Control Panel

The Control Panel can be used to configure camera settings.

1. In the REC mode, press [SET].

- You can also display the Control Panel by pressing [▼].

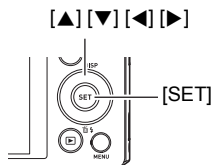

2. Use [▲] and [▼] to select the item you want, and use [◀] and [▶] to select the setting you want.

This will select one of the Control Panel icons and display its settings.*

- 1 Self-timer (page 39)
- 2 White balance (page 40)
- 3 Focus (page 42)
- 4 ISO sensitivity (page 45)
- 5 Make-up Level (page 46)
- 6 EV shift (page 47)
- 7 Flash (page 48)
- 8 Metering (page 50)

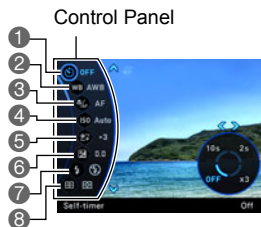

* Items displayed in the Control Panel depend on the recording mode.

3. After all of the settings are the way you want, press [SET].

This will apply the settings and return to the REC mode.



NOTE

- You also can use on-screen menus to configure settings other than those listed above (page 92).

Using the Self-timer (Self-timer)

With the Self-timer, pressing the shutter button starts a timer. The shutter is released and the image is shot after a fixed amount of time.

1. In the REC mode, press [SET].
2. Use [▲] and [▼] to select the ⌚ (Self-timer) Control Panel option.
3. Use [◀] and [▶] to select the setting you want and then press [SET].

Setting	REC Screen Icon Display	Description
10s 10 sec		10-second Self-timer
2s 2 sec		2-second Self-timer <ul style="list-style-type: none">• When shooting under conditions that slow down the shutter speed, you can use this setting to prevent image blur due to camera movement.
x3 x3 (Triple Self-timer)		Shoots three images: one image 10 seconds after the shutter button is pressed, and the next two images as soon as the camera is ready after shooting the previous image. How long it takes for the camera to get ready to shoot depends on the image size and quality settings, whether or not a memory card is loaded in the camera, and the flash charge condition.
OFF Off	None	Turns off the Self-timer.

- The front lamp flashes while the Self-timer countdown is in progress.
- You can interrupt an ongoing Self-timer countdown by pressing [SET].

Front lamp

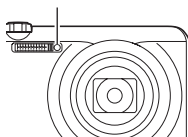















NOTE



- The Self-timer cannot be used together with the following features.
High Speed CS with Prerecord CS, Prerecord (Movie), Lag Correction, Slide Panorama, Wide Shot, Triple Shot
- The Triple Self-timer cannot be used together with the following features.
Movie, High Speed CS, Multi SR Zoom, High Speed Night Shot, High Speed Best Selection, For YouTube, Blurred Background, All-In-Focus Macro

Adjusting White Balance (White Balance)

You can adjust white balance to match the source of light available where you are shooting and avoid the blue cast that results when shooting outdoors when it is cloudy, and the green cast that results when shooting under fluorescent lighting.

1. In the REC mode, press [SET].
2. Use [▲] and [▼] to select the  (White Balance) Control Panel option.
3. Use [◀] and [▶] to select the shooting condition you want and then press [SET].









Setting	REC Screen Icon Display	Description
 Auto WB	None	Configures the camera to adjust white balance automatically.
 Daylight		For shooting outdoors on a clear day
 Overcast		For shooting outdoors on an overcast rainy day, in the shade, etc.
 Shade		For shooting on a clear day in the shade of trees or buildings
 DayWhite Fluorescent		For shooting under white or day white fluorescent lighting
 Daylight Fluorescent		For shooting under daylight fluorescent lighting
 Tungsten		For shooting under light bulb lighting

Setting	REC Screen Icon Display	Description
MWB Manual WB		<p>For configuring the camera manually to suit a particular light source</p> <ol style="list-style-type: none"> ① Select "Manual WB". ② Under the lighting conditions you plan to use when shooting, point the camera at a blank white piece of paper so it fills the entire monitor screen and then press the shutter button. ③ Press [SET]. <p>The white balance setting is retained even if you turn off the camera.</p> <div style="text-align: right;"> <p>Blank white paper</p>  </div>

- When "AWB Auto WB" is selected for the white balance setting, the camera automatically determines the white point of the subject. Certain subject colors and light source conditions can cause problems when the camera tries to determine the white point, which makes proper white balance adjustment impossible. If this happens, select the white balance setting that matches your shooting conditions (Daylight, Overcast, etc.).

Selecting a Focus Mode (Focus)

1. In the REC mode, press [SET].
2. Use [▲] and [▼] to select the  (Focus) Control Panel option.
3. Use [◀] and [▶] to select the setting you want and then press [SET].

Settings	REC Screen Icon Display	Type of Shot	Focus Mode		Approximate Focus Range*1	
			Snapshot	Movies	Snapshot	Movies
 AF (Auto Focus)	None	General recording	Automatic	Automatic*3	5 cm to ∞ (infinity) (2.0" to ∞) (Wide Angle)*2	
 Macro		Close ups			1 cm to 50 cm (0.4" to 19.7") (Fifth step zoom from the Widest Angle setting)*2	
 Super Macro		Close ups			1 cm to 50 cm (0.4" to 19.7")	
 Infinity Focus		Scenery and other distant subjects	Fixed		Infinity (Wide Angle)	
 MF (Manual Focus)		When you want to focus manually	Manual		5 cm to ∞ (infinity) (2.0" to ∞) (Wide Angle)*2	

*1 The focus range is the distance from the lens surface.

*2 The focus range depends on the current optical zoom position.

*3 During High Speed Movie recording, focus is fixed at the position where it was when recording started. To focus an image, half-press the shutter button for Auto Focus or focus manually before you press [●] (Movie) to start recording.

Super Macro

Super Macro fixes optical zoom at a position that allows you to shoot from the closest distance to the subject. The result is closer and larger subject images.

NOTE

- Zoom is fixed while Super Macro is selected, so no zoom operation is performed when you rotate the zoom controller.

To focus with manual focus

1. On the monitor screen, compose the image so the subject you want to focus on is within the yellow boundary.

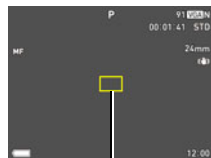

Yellow boundary

2. Watching the image on the monitor screen use [◀] (nearer) and [▶] (further) to adjust focus.

- At this time the image that is within the boundary will enlarge and fill the monitor screen, which aids in focusing. If you do not perform any operation for two seconds while the enlarged image is displayed, the screen in step 1 will re-appear.

NOTE

- An Auto Macro feature detects how far the subject is from the lens and automatically selects either Macro Focus or Auto Focus accordingly.
- Use of the flash together with Macro Focus can cause the light of the flash to become blocked, which may result in unwanted lens shadows in your image.
- In the case of movie recording, Auto Macro operates before you start recording. After recording is started, however, focus is fixed.
- Whenever you perform an optical zoom operation while shooting with Auto Focus, Macro Focus, or Manual Focus, a value will appear on the monitor screen to tell you the focus range, as shown below. Note that the focus range is displayed including the Auto Macro range only when shooting with Auto Focus.



Example: ○○* cm - ∞

* ○○ is the actual focusing range value.

- The operations assigned to the [◀] and [▶] keys with the "L/R Key" setting (page 93) are disabled while Manual Focus is selected as the focus mode.
- The "Focus" setting is always fixed at "AF" (Auto Focus) whenever "Face Detection" is being used. If you want to change the "Focus" setting, first select "Off" for "Face Detection".

Using Focus Lock

“Focus lock” is a technique you can use when you want to compose an image in which the subject you want to focus on is not within the focus frame in the center of the screen.

- To use focus lock, select “ Spot” or “ Tracking” for the Auto Focus area (page 99).

1. Align the monitor screen’s focus frame with the subject you want to focus on and then half-press the shutter button.

Subject to be focused on

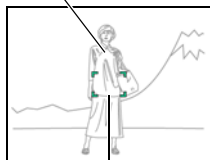

Focus frame

2. Keeping the shutter button half-pressed (which maintains the focus setting), move the camera to compose the image.

- When “ Tracking” is selected as the Auto Focus area, the focus frame will move automatically and follow the subject.



3. When you are ready to shoot the image, press the shutter button the rest of the way down.







NOTE

- Focus lock also locks exposure (AE).

Specifying ISO Sensitivity (ISO)

ISO sensitivity is a measure of sensitivity to light.

1. In the REC mode, press [SET].
2. Use [▲] and [▼] to select the  (ISO Sensitivity) Control Panel option.
3. Use [◀] and [▶] to select the setting you want and then press [SET].

Setting	REC Screen Icon Display	Description		
Auto	None	Adjusts sensitivity automatically according to conditions.		
ISO80		Lower sensitivity ↑ ↓ Higher sensitivity	Slow shutter speed ↑ ↓ Fast shutter speed (Set for shooting in dimly lit areas.)	Less noise ↑ ↓ Some coarseness (increased digital noise)
ISO100				
ISO200				
ISO400				
ISO800				
ISO1600				
ISO3200				

- While “Auto” is selected, Anti Shake corrects for subject movement only (page 100).
- Since higher ISO sensitivity values tend to result in digital noise in images, the camera performs a noise filtering process. Because of this, it may take relatively longer for the camera to finish recording an image after it is shot. You will not be able to perform any key operation while image recording is in progress.

Recording Beautiful Portraits (Make-up Level)

The Make-up Function smoothes the skin texture of the subject and softens facial shadows caused by harsh sunlight for better looking portraits. You can select a make-up level within the range of “0 (Off)” to “+12 (Max.)”.

- 1. Enter the REC mode, and then press [SET].**

- 2. Use [▲] and [▼] to select the  (Make-up Level) Control Panel option.**

- 3. Use [◀] and [▶] to select the Make-up Level setting you want, and then press [SET].**
 - You can select a make-up level within the range of “0 (Off)” to “+12 (Max.)”.

- 4. Shoot the image.**

NOTE

- Selecting any Make-up Level setting from +1 (Min.) to +12 (Max.) causes the settings below to be configured automatically.
 - Face Detection: On
 - Focus Mode: AF (Auto Focus)
- Make-up cannot be used with the following functions.
Some BEST SHOT scenes, ART SHOT, Multi SR Zoom, High Speed CS

Correcting Image Brightness (EV Shift)

You can manually adjust an image's exposure value (EV value) before shooting it.

- Exposure Compensation Range: -2.0 EV to +2.0 EV
- Unit: 1/3EV

1. In the REC mode, press [SET].

2. Use [▲] and [▼] to select the  (EV Shift) Control Panel option.

3. Use [◀] and [▶] to adjust the exposure compensation value.

[◀]:

Increases the EV value. A higher EV value is best for light-colored subjects and backlit subjects.

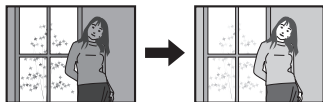

[▶]:

Decreases the EV value. A lower EV value is best for dark-color subjects and for shooting outdoors on a clear day.



To cancel exposure compensation, change the EV value to 0.0.



Exposure compensation value

4. Press [SET].

This applies the exposure compensation value. The exposure compensation value you set remains in effect until you change it or turn off the camera (which causes it to revert to "0.0").

NOTE

- When shooting under very dark or very bright conditions, you may not be able to obtain satisfactory results even after performing exposure compensation.

Using Flash (Flash)

1. In the REC mode, press [▼] (🗑️ ⚡) once.
2. Use [◀] and [▶] to select the flash setting you want and then press [SET].

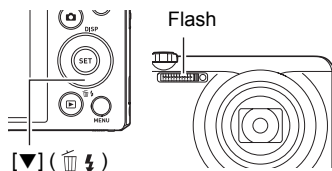

Setting	REC Screen Icon Display	Description
⚡A Auto Flash	None	Flash fires automatically in accordance with exposure (amount of light and brightness) conditions.
🔌 Flash Off		Flash does not fire.
⚡ Flash On		Flash always fires. This setting can be used to brighten a subject that normally comes out dark due to daylight or backlight (daylight synchro flash).
👁️ Red Eye Reduction		Flash fires automatically. This type of flash can be used to reduce the chance of redness in the subject's eyes.

3. Press the shutter button to shoot.

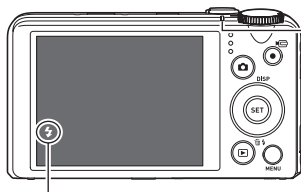

Back lamp

Flashes orange while the flash is charging to indicate that image recording is disabled.

- You will not be able to take another flash snapshot until the lamp stops flashing orange, which indicates that charging is complete.





⚡ indicates the flash will fire.

- For information about Flash Range, see page 196.

IMPORTANT!

- Foreign matter on the flash window can react with the light of the flash, producing some smoke and abnormal odor. Though this does not indicate malfunction, oil from your fingers and other foreign matter when left on the flash window can become difficult to clean off later. Because of this, you should make it a regular habit to wipe the window clean regularly with a soft, dry cloth.

NOTE

- Take care so your fingers and the strap do not block the flash.
- The desired effect may not be obtained when the subject is too far away or too close.
- Flash charging time (page 196) depends on operating conditions (battery condition, ambient temperature, etc.).
- Shooting with flash turned off when lighting is dim results in a slow shutter speed, which can cause image blur due to camera movement. Under such conditions, secure the camera with a tripod, etc.
- With red eye reduction, the flash is fired automatically in accordance with exposure. It does not fire in areas where lighting is bright.
- The presence of outdoor sunlight, fluorescent lighting, or some other light source can cause abnormal image colors.
- Select  (Flash Off) for the flash setting when shooting in areas where flash photography is prohibited.
- The flash  (Auto Flash) and  (Red Eye Reduction) flash modes are not supported while A, S, or M is selected for the recording mode. If you want the flash to fire, select  (Flash On) as the flash mode.

Red-eye Reduction

Using the flash to shoot at night or in a dimly lit room can cause red spots inside the eyes of people who are in the image. This is caused when the light from the flash reflects off of the retina of the eye. When red-eye reduction is selected as the flash mode, the camera fires a pre-flash to cause the irises in the eyes of any people in the image to close, which reduces the chance of red eye.





Note the following important points when using red-eye reduction.

- Red-eye reduction does not work unless the people in the image are looking directly at the camera (flash).
- Red-eye reduction may not work very well if the subjects are located far away from the camera.

Specifying the Metering Mode (Metering)

The metering mode determines what part of the subject is metered for exposure.

1. In the REC mode, press [SET].
2. Use [▲] and [▼] to select the  (Metering) Control Panel option.
3. Use [◀] and [▶] to select the setting you want and then press [SET].

Setting	REC Screen Icon Display	Description
 Multi	None	Multi-pattern metering divides the image into sections and measures the light in each section for a balanced exposure reading. This type of metering provides error-free exposure settings for a wide range of shooting conditions.
 Center Weighted		Center weighted metering concentrates on the center of the focus area to measure light. This type of metering is best when you want some level of control over contrast.
 Spot		Spot metering takes readings at a very small area. Use this metering method when you want exposure to be set according to the brightness of a particular subject, without being affected by surrounding conditions.

Shooting with Zoom

Your camera is equipped with various types of zoom: optical zoom, HD Zoom, Single SR Zoom, Multi SR Zoom, and digital zoom. The maximum zoom factor depends on the image size setting and the digital zoom on/off settings.

Optical zoom	Zooming is performed by changing the lens focal distance, so there is no deterioration of image quality.
HD Zoom	Allows greater zoom capabilities by cutting out a portion of the original image and enlarging it, without deterioration of image quality.
Single SR Zoom	Applies super resolution technology to suppress image deterioration (page 54).
Multi SR Zoom	Shoots a burst of high-speed images, which are then combined into a final image in a way that lessens deterioration of image quality. Multi SR Zoom is enabled only when the “Multi SR Zoom” recording mode is selected. (page 55)
Digital zoom	A digital process is used to enlarge the center of the image, so there is deterioration of image quality.

1. In the REC mode, rotate the zoom controller to zoom.



 Wide Angle



 Telephoto

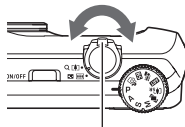

Zoom controller

 (Wide Angle): Reduces the size of the subject and broadens the range.

 (Telephoto) : Enlarges the subject and narrows the range.

2. Press the shutter button to shoot.

NOTE

- Use of a tripod is recommended to protect against image blur due to camera movement when shooting with telephoto.
- Performing a zoom operation changes the lens aperture.
- Zoom operations are supported during movie recording. Zoom operations are disabled during high speed movie recording. To use zoom, perform the zoom operation before you press  (Movie) to start recording.
- Zoom operations are not supported while shooting with the following feature. The zoom setting is fixed at full wide angle.
Slide Panorama, Wide Shot, All-In-Focus Macro

Monitor Screen Information when Zooming

A variety of information is shown on the monitor screen while a zoom operation is in progress.

Zoom Mode Icons

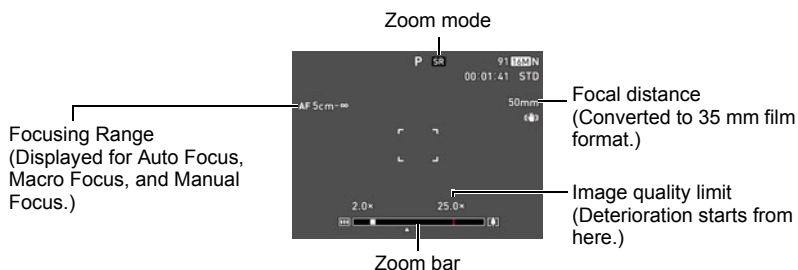

The table below shows what appears on the monitor screen based on the zoom mode.

Zoom mode	REC Screen Icon Display
Optical zoom	None
HD Zoom	None
Single SR Zoom	SR (White)
Multi SR Zoom	SR (Black)
Digital zoom	Q

■ Interpreting the Zoom Bar

During a zoom operation, a zoom bar appears on the monitor screen to show the current zoom setting.

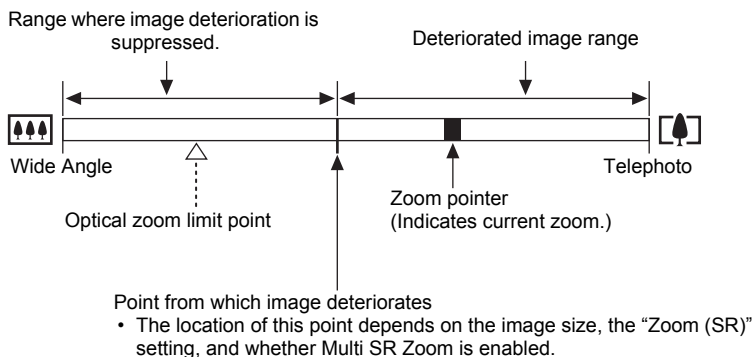

■ Zoom Factor

The digital zoom factor depends on the image size (page 94), the super resolution zoom setting, and on whether or not "Multi SR Zoom" is selected (page 55).

- Multi SR Zoom is enabled only when the "Multi SR Zoom" recording mode is selected.

Image size	Optical zoom	Maximum zoom factor where image deterioration can be suppressed		Total maximum zoom factor (In combination with digital zoom)
		Zoom (SR): Off (HD Zoom)	Multi SR Zoom Zoom (SR): Single	
16M	12.5X	12.5X	25.0X	50.0X
3:2	12.5X	12.5X	25.0X	50.0X
16:9	12.5X	12.5X	25.0X	50.0X
10M	12.5X	15.8X	31.6X	63.1X
5M	12.5X	22.5X	45.0X	90.0X
3M	12.5X	28.1X	56.3X	112.3X
VGA	12.5X	90.0X	179.6X	199.3X

Zooming with Super Resolution (Zoom (SR))

There are two types of Super Resolution Zoom: Single SR Zoom and Multi SR Zoom. Single SR Zoom uses super resolution to expand the zoom range in which image quality deterioration is minimized. Multi SR Zoom shoots a series of High Speed CS images, which are then combined into an image that enables shooting at higher zoom ratios without loss of image quality. For information about the effective zoom factor ranges in which Super Resolution Zoom is effective, see page 53.

The procedure below shows how to configure Single SR Zoom settings. For information about Multi SR Zoom, see page 55.

- 1. In the REC mode, press [MENU].**

- 2. Press [◀], use [▲] and [▼] to select the “📷 REC MENU” tab, and then press [▶].**

- 3. Use [▲] and [▼] to select “Zoom (SR)” and then press [SET].**

- 4. Use [▲] and [▼] to select “Single” and then press [SET].**

NOTE

- Single SR Zoom is effective when you want to capture delicate textures.
- Single SR Zoom does not work during movie recording.
- The following functions are disabled when shooting with Single SR Zoom.
Triple Self-timer, ART SHOT, Multi SR Zoom, Triple Shot, some BEST SHOT scenes

Expanding the Zoom Range to Shoot Clearer Snapshots (Multi SR Zoom)

This feature uses super resolution technology and multiple Continuous Shutter (CS) images to expand the zoom range for overall images of higher quality and clarity (page 54).

1. Align the mode dial with [M_{SR}] (Multi SR Zoom).

2. Press the shutter button to shoot.

NOTE

- Multi SR Zoom is effective when you want to capture delicate textures.
- The following functions are disabled when shooting with Multi SR Zoom. Single SR Zoom, Triple Self-time, Sharpness, Contrast
- With Multi SR Zoom, the flash setting automatically becomes  (Flash Off).
- Shooting with this function automatically sets Anti Shake to "Standard" (page 100), but large movement of the camera or subject make it impossible to achieve the desired shot.
- Depending on shooting conditions and image composition, Multi SR Zoom may not be able to produce the desired result.
- When shooting with this feature, "ISO 3200" cannot be selected for "ISO Sensitivity" (page 45).

Shooting a Burst of Images (High Speed CS)

Pressing [] (Continuous Shutter) toggles between the Continuous Shutter mode and the Single Shot mode (page 28).

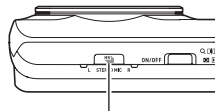

[] (Continuous Shutter)



■ Shooting with High Speed CS

With High Speed CS, recording continues as long as you keep the shutter button depressed.

The table below shows the settings that can be specified for the CS speed and the number of images per High Speed CS operation.

CS Speed (High Speed CS (fps))	3 fps, 5 fps, 10 fps, 15 fps, 30 fps fps = frames per second
Maximum CS Shots	5, 10, 20, 30

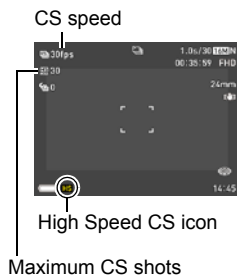

1. Align the mode dial with [P] (Program Auto).

2. Press [] (Continuous Shutter).

- This will display [] (High Speed CS). If this does not happen, press [] again.

3. Press [SET].

4. Use [▲] and [▼] to select the (High Speed CS fps) Control Panel option.

5. Use [◀] and [▶] to select the continuous shutter (CS) speed you want.

- Use a higher “High Speed CS fps” setting when shooting a fast-moving subject.

6. Use [▲] and [▼] to select the (Maximum CS Shots) Control Panel option.

7. Use [◀] and [▶] to select the maximum number of shots and then press [SET].

8. Press the shutter button the rest of the way and hold it down.

Shooting of images will continue as long as you depress the shutter button or until the maximum number of images specified by “High Speed CS fps” is reached.

■ Shooting with Prerecord CS

Half-pressing and holding the shutter button causes a pre-record buffer to be continually updated with images. When the shutter button is fully pressed, buffer contents are recorded along with a series of real-time images. Use Prerecord CS when you want to make sure you do not miss fast-moving action.

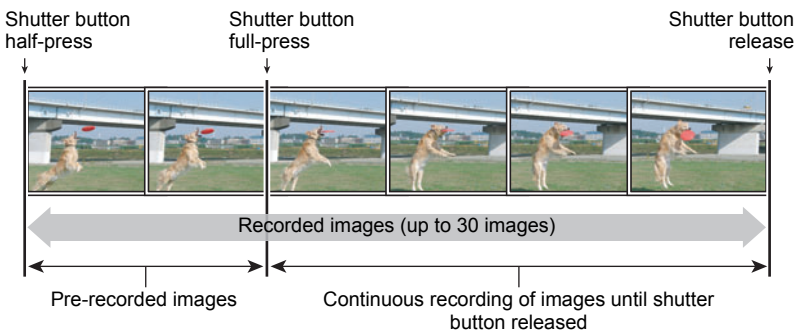

1. Align the mode dial with [P] (Program Auto).

2. Press [HS] (Continuous Shutter).

3. Press [SET].

4. Use [▲] and [▼] to select the  (High Speed CS fps) Control Panel option.

5. Use [◀] and [▶] to select the continuous shutter (CS) speed you want.
 - Use a higher “High Speed CS fps” setting when shooting a fast-moving subject.

6. Use [▲] and [▼] to select the  (Maximum CS Shots) Control Panel option.

7. Use [◀] and [▶] to select the maximum number of shots.

8. Use [▲] and [▼] to select the  (Pre-record CS Shots) Control Panel option and then press [SET].

9. Use [◀] and [▶] to select the number of Prerecord (Still) images and then press [SET].
 - Settings: 0 shots, 3 shots, 5 shots, 10 shots, 15 shots, 20 shots, 25 shots
 - If you select “0 shots”, no pre-record images will be stored when you half-press the shutter button.

10. Half-press and hold the shutter button to start pre-recording.

A pre-record buffer is continually updated with images as long as the shutter button is pressed.

- The camera will not emit shutter sounds as it pre-records images.
- Releasing the half-pressed shutter button will cause the contents of the pre-record buffer to be deleted.

11. Full press and hold down the shutter button.

This will record the images in the pre-record buffer followed by real-time recorded images. Shooting of images will continue as long as you depress the shutter or until the maximum number of images specified by “High Speed CS fps” is reached.

■ Continuous Shutter Precautions

- You can use the Manual Mode while a continuous shutter mode is selected. To do so, set the mode dial to [A], [S], or [M].
- The greater the number of shots, the longer it takes to save them after shooting is complete.
- When using a continuous shutter mode, keep the camera still until shooting is finished.
- Zoom is disabled during continuous shutter operations.
- When shooting with this function, the snapshot image quality automatically changes to “Normal”.
- When shooting with this function, exposure and focus for the first image are applied for successive images as well.
- When shooting with this function, the flash setting automatically becomes  (Flash Off).
- The following image sizes cannot be selected while shooting with this function: “3:2”, “16:9”. Entering the High Speed CS mode while any one of these image sizes is selected will cause the image size setting to change to “16M” automatically.
- The Triple Self-time cannot be used when shooting with this function.
- The Self-timer cannot be used in the Prerecord CS mode.
- Single SR Zoom and Multi SR Zoom cannot be used when shooting with this function.

Using Focus Control

You can use Focus Control to configure the camera so the background is blurred and only the foreground subject is in focus (Blurred Background), or so everything is in focus (All-In-Focus Macro).

Shooting with a Blurred Background (Blurred Background)

This function analyzes a burst of consecutive images and then blurs the background behind the main subject. This creates an effect that really makes the subject stand out, just like photographs taken with a single-lens reflex camera. The blur effect can be set to one of three levels.



Shot with "Program Auto".



Shot with "Blurred Background".

1. Align the mode dial with  (Focus Control).

2. Press [SET].

3. Use [▲] and [▼] to select , and then press [SET].

4. Use [◀] and [▶] to select "Blurred Background" and then press [SET].

5. Press [SET] and then use [▲] and [▼] to select the  (Blur Effect) Control Panel option.

6. Use [◀] and [▶] to select the Image Blur level you want, and then press [SET].
 - The Image Blur level can be set to Level 1, Level 2, or Level 3.

7. Press the shutter button to shoot.
 - Get as close as possible to the subject. Also, the background should be as far away as possible from the subject. The required distances depend on the zoom factor being used.
Example: When zoom is set to full wide (W), the distance between the camera and subject should be 30cm, while the distance between the subject and background should be at least 1 meter.
 - This will cause the message "Busy... Please wait..." to appear. Do not move the camera while this message is displayed. The recording process takes some time to complete after the message appears.

NOTE

- The current “Zoom (SR)” (page 54) setting is ignored when shooting with this function.
- With this function, the flash setting automatically becomes  (Flash Off).
- Shooting with this function automatically sets Anti Shake to “Standard” (page 100), but large movement of the camera or subject make it impossible to achieve the desired shot.
- Depending on the shooting environment, image composition, and subject, this scene may not be able to produce the desired result.
- If the camera determines that it is unable to blur the background of an image for some reason, it will display the message “Blurring failed. Normal background recorded.”. Note, however, that the image will be saved, even if background blurring is not possible.

Shooting with Full Focus Macro (All-In-Focus Macro)

All-In-Focus Macro shoots and analyzes a burst of multiple images and combines them in a way that produces an image in which everything is in focus: from nearby objects to distant objects.



“Program Auto” image



All-In-Focus Macro

1. Align the mode dial with  (Focus Control).

2. Press [SET].

3. Use [▲] and [▼] to select , and then press [SET].

4. Use [◀] and [▶] to select “All-In-Focus Macro” and then press [SET].

5. Press the shutter button to shoot.

- Move the camera as close to the subject as possible, and take care to avoid camera movement and subject movement as you shoot.
- After you press the shutter button, the message “Busy... Please wait...” will appear on the monitor screen to let you know that shooting is in progress. Do not move the camera while this message is displayed. The recording process takes some time to complete after the message appears. Image shooting is disabled while the message is displayed.

NOTE

- When shooting with this function, zoom is fixed at wide angle.
- When shooting with this function, the flash setting automatically becomes  (Flash Off).
- Shooting with this function automatically sets Anti Shake to “Standard” (page 100), but large movement of the camera or subject make it impossible to achieve the desired shot.
- Depending on shooting conditions, image composition, and the subject you are shooting, this scene may not be able to produce the desired result.
- The message “Image merging failed.” will appear if the All-In-Focus Macro process cannot be performed for some reason. The images shot by the camera will be saved even if they cannot be merged.

Shooting with Artistic Effects (ART SHOT)

A variety of artistic effects help to make even common, ordinary subjects become more novel and exciting.

Scene	Description
HDR Art	Applies HDR (High Dynamic Range, page 77) photography to transform snapshots and movies into works of art that provide a greater degree of expression than conventional imaging.
Toy Camera	Darkens the periphery and changes hues for a toy camera effect.
Soft Focus	Blurs overall focus for a mysteriously soft effect.
Light Tone	Weakens contrast to create an elegantly subdued effect.
Pop	Strengthens saturation for richer colors.
Sepia	Sepia colors are used to create a retro effect.
Monochrome	Enhances contrast to create a grainy print effect.
Miniature	Blurs some of the focus to make the image look like a miniature.
Fisheye	Humorous effect that looks like it was shot with a fisheye lens.

1. Align the mode dial with [ART] (ART SHOT).

2. Press [SET].

3. Use [▲] and [▼] to select , and then press [SET].

4. Select the ART SHOT scene you want to use and then press [SET].

Select from among: HDR Art, Toy Camera, Soft Focus, Light Tone, Pop, Sepia, Monochrome, Miniature, Fisheye

5. Press [SET], use [▲] and [▼] to select the fifth Control Panel option from the top.

The intensity of the selected effect can be adjusted as described below.

Scene	Adjustment
HDR Art	Effect level
Toy Camera	Hue
Soft Focus	Effect level
Light Tone	Hue
Pop	Effect level
Sepia	Effect level
Monochrome	Effect level
Miniature	Focus area
Fisheye	Effect level

6. Use [◀] and [▶] to change the setting.

7. Press [SET].

8. Press the shutter button to shoot.

■ Using the Scene Information Screen

To find out more about a scene, select it with the boundary on the scene menu and then rotate the zoom controller in either direction.

- To return to the scene menu, rotate the zoom controller again.
- To scroll between scenes, use [◀] and [▶].
- To configure the camera with the settings for the currently selected scene, press [SET].

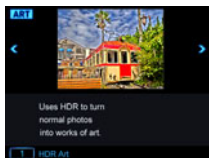

NOTE

- Depending on the “ART SHOT” scenes, some of the items on the menu that appears may not be usable.
- In the “ART SHOT” scene, the flash setting automatically become  (Flash Off).
- With HDR Art Movie, the “Movie Quality” setting can be either “HD” or “STD” only (page 96). When any “Movie Quality” setting other than “STD” is selected in another mode, the “HD” setting is used when shooting with HDR Art Movie.
- When using “HDR Art” for movie recording, the intensity of the art effect is fixed in accordance with movie settings.

Saving a Second Normal Image When Shooting With HDR Art (Double (HDR Art))

You can configure the camera to save two images when shooting with HDR Art: one image with HDR Art effects applied in accordance with the scene you selected plus another normal (Program Auto) image without any effects applied.

1. Align the mode dial with [ART] and then press [MENU].
2. Press [◀], use [▲] and [▼] to select the “ REC MENU” tab, and then press [▶].
3. Use [▲] and [▼] to select “Double (HDR Art)” and then press [SET].
4. Use [▲] and [▼] to select “On” and then press [SET].
While “Off” is selected for the above step, only a single HDR Art image is saved (normal image not saved).
5. Press the shutter button to shoot.

Shooting with Triple Shot

Triple Shot shoots a burst of three images and stores them in memory. This feature is great for making sure you don't miss those special moments when kids are around.

- 1. Align the mode dial with [📷] (Triple Shot).**
- 2. Point the camera at the subject and then half-press the shutter button.**

The camera will start pre-recording images at this time.

 - If you release the half-pressed shutter button before pressing it the rest of the way down, all of the images currently in the pre-record buffer will be deleted.
- 3. Press the shutter button all the way down to record.**

This will record three images: one of the action before the shutter button is fully pressed plus two real-time images.

 - Pressing the shutter button all the way without first half-pressing it will result in only two images being recorded.

NOTE

- The settings in the table below are fixed while shooting with this function.

Self-timer	Off
Flash	Flash Off
Image Quality	Normal
Single SR Zoom	Off
Face Detection	On
Focus Mode	AF
AF Area	"Intelligent" or "Spot"*

- * If you select "📷 Multi" or "📷 Tracking" for this setting in another mode and then shoot with Triple Shot, shooting is performed using the "📷 Spot" setting.

Recording Movies

To record a movie

The following procedure explains how to record a standard (STD) movie.

This camera supports Premium Auto PRO movie recording (page 66).

See the pages indicated below for more information about movies.

High-definition movie (FHD movie): page 68

High speed movie (HS movie): page 68

1. Align the mode dial with [P] (Program Auto) or [P] (Premium Auto PRO).

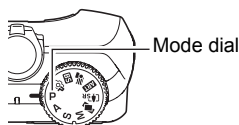

2. Press [MENU].

3. Press [◀], use [▲] and [▼] to select the "REC MENU" tab, and then press [SET].

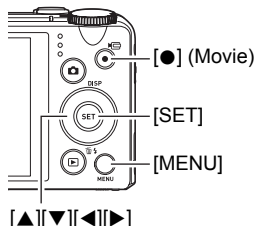

4. Use [▲] and [▼] to select "Movie Quality" and then press [▶].

5. Use [▲] and [▼] to select "STD" (Standard), and then press [SET].

- Recording is performed with an aspect ratio of 4:3, an image size of 640×480 pixels, and a frame rate of 30 frames per second (STD Movie). Image size setting cannot be changed.
- The semi-transparent gray frame on the monitor screen indicates the area that is recorded when shooting a movie. The area within the frame is recorded for a movie.



Semi-transparent gray frame

6. Press [●] (Movie).

This will start recording and display **REC** on the monitor screen.

Movie recording includes stereo audio.

7. Press [●] (Movie) again to stop recording.

- Each movie can be up to 29 minutes long. Movie recording stops automatically after 29 minutes of recording. Movie recording also will stop automatically if memory becomes full before you stop movie recording by pressing [●] (Movie) again.

Recording time



Remaining recording time (page 192)

Recording Movies with Premium Auto PRO

When Premium Auto PRO is enabled (page 28), the camera automatically make judgments about the subject, shooting conditions, and other parameters. The result is higher quality images than those produced by Program Auto recording. The shooting environment detected by the camera is displayed at the bottom of the REC mode screen.



- Premium Auto PRO is enabled for FHD movies and STD movies only.
- Using Premium Auto PRO uses up the battery charge more quickly than using Program Auto recording.

Shooting with BEST SHOT

With BEST SHOT (page 74), you can select the sample scene that matches the type of movie you are trying to shoot and the camera will change its setup accordingly, for beautiful movies every time.

Minimizing the Effects of Camera Movement during Movie Recording

You can use Anti Shake (page 100) to configure the camera to minimize the effects of camera movement during FHD and STD movie recording. Note that Anti Shake cannot be used with HDR Art Movie and that Anti Shake does not prevent image blur due to subject movement.

Audio

Your camera has built-in microphones that can be used to record audio (stereo) during movie recording.

- Your camera has a function to reduce wind noise (Wind Noise Cut) when recording movies (page 103).

Recording Precautions

- The camera also records audio. Note the following points when shooting a movie.
 - Take care that the microphones are not blocked by your fingers, etc.
 - Good audio recording results are not possible when the camera is too far away from what you are trying to record.
 - Performing a zoom operation while shooting can cause zoom and/or auto focus noise to be in the audio recording.
 - Operating camera buttons while shooting can cause button noise to be picked up in the audio.
- When shooting with the “HS” movie mode at a frame rate setting of “30-120 fps” or “30-240 fps”, audio is recorded only while the camera is shooting at 30 fps. Audio is not recorded at any other frame rates.

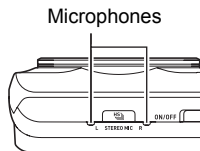



IMPORTANT!

- Spending a long time using movie recording will cause the camera to become slightly warm to the touch. This is normal and does not indicate malfunction.
- Shooting movies for long periods in areas where temperature is relatively high can cause digital noise (dots of light) to appear in the movie image. A rise in the camera's internal temperature also may force movie recording to stop automatically. If this happens, stop recording and allow the camera to cool down, which should cause normal operation to resume.
- Using the camera's built-in memory or certain types of memory cards can slow down processing speed. Whenever possible use an Ultra High-Speed Type memory card. Note, however, that not all operations can be guaranteed even if an Ultra High-Speed Type memory card is used. Certain movie quality settings can result in too much time being required to record data, which can result in breaks in the image and/or audio during playback. If this happens, the **REC** will turn yellow on the monitor screen.

NOTE

- Zoom operations are supported during movie recording (page 51). Zoom is disabled during high speed movie recording. To use zoom for high speed movie recording, perform the zoom operation before you press **[M]** (Movie) to start recording.
- Both Single SR Zoom (page 54) and Multi SR Zoom (page 55) are disabled during movie recording.
- The effects of camera movement in an image become more pronounced when you shoot close up or with a large zoom factor. Because of this, use of a tripod is recommended under these conditions.
- Except for High Speed Movie, Continuous AF (page 102) is performed during movie recording while "AF" (Auto Focus) or "Macro" is selected for the "Focus" setting.
- Face Detection is disabled during normal FHD and STD, and high speed movie recording. Face Detection is enabled when shooting movies with Premium Auto PRO (FHD and STD).
- The following functions do not support movie recording. Blurred Background, All-In-Focus Macro, Triple Shot, Multi SR Zoom, some BEST SHOT scenes
- The A, S, and M recording modes are not supported when shooting a movie, or when using the "Prerecord (Movie)" and "For YouTube" BEST SHOT scenes. In these cases, the recording mode is always **P** (Program Auto).

Recording a High-definition Movie

This camera supports recording of high-definition (FHD) movies. The aspect ratio of an FHD movie is 16:9, the image size is 1920×1080 pixels, and the frame rate is 30 fps. Image quality and image size settings cannot be changed.

1. Align the mode dial with [P] (Program Auto) or [P] (Premium Auto PRO).

2. Press [MENU].

3. Press [◀], use [▲] and [▼] to select the “📷 REC MENU” tab, and then press [SET].

4. Use [▲] and [▼] to select “Movie Quality” and then press [▶].

5. Use [▲] and [▼] to select “FHD”, and then press [SET].

6. Record the movie the same way as you would a normal movie (page 65).
Press [●] (Movie) to start and stop recording.

Recording a High Speed Movie

This camera supports recording of high speed movies at a maximum speed of 1000 fps. The aspect ratio of movies recorded with this mode depends on the frame rate (recording speed).

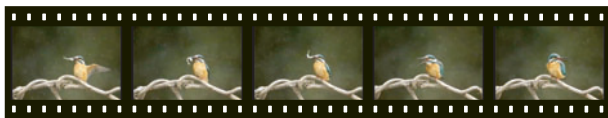

- When recording with the frame rate setting of “30-120 fps” or “30-240 fps” frame rate setting, audio recording is supported during 30 fps recording only. Audio is not recorded at any other frame rates.
1. Align the mode dial with [P] (Program Auto).

 2. Press [MENU].

 3. Press [◀], use [▲] and [▼] to select the “📷 REC MENU” tab, and then press [SET].

4. Use [▲] and [▼] to select “Movie Quality” and then press [▶].

5. Use [▲] and [▼] to select the frame rate (recording speed) you want and then press [SET].

A fast frame rate (such as 1000 fps) will result in a smaller image size.

Movie Quality	REC Screen Icon Display	Frame Rate	Image Size (Pixels)
HS1000		1000 fps	224×64
HS480		480 fps	224×160
HS240		240 fps	512×384
HS120		120 fps	640×480
HS30-240		30-240 fps	512×384
HS30-120		30-120 fps	640×480

• fps (frames per second) is a unit of measurement indicating the number of images recorded or played back per second.

6. Record the movie the same way as you would a normal movie (page 65).

Press [●] (Movie) to start and stop recording.

- During High Speed Movie recording (HS120, HS240, HS480, HS1000), focus is fixed at the position where it was when recording started. To focus an image, half-press the shutter button for Auto Focus or focus manually before you press [●] (Movie) to start recording.
- Continuous AF is operational when recording at 30 fps with “HS30-120” or “HS30-240”. However, focus becomes fixed whenever you switch to 120 fps or 240 fps.
- When “HS30-120” or “HS30-240” is selected as the frame rate, recording always starts with a frame rate of 30 fps. You can switch the frame rate between 30 fps and 120 fps or between 30 fps and 240 fps only while recording is in progress. Press [◀], [▶], or [SET] to switch speeds. Audio is recorded only while shooting at a 30 fps.

NOTE

- The higher the frame rate (speed), the more lighting is required when shooting. When shooting a high speed movie, shoot in a well-lit environment.
- When recording certain types of movies, the image that appears on the monitor screen may be smaller than normal. When recording a high speed movie, there are black bands along the top, bottom, left, and right of the screen.
- When recording a high speed movie, light source flicker can cause horizontal bands to appear in the image. This does not indicate malfunction of the camera.
- Monitor screen content switching is disabled during high speed movie recording.

Using Prerecord Movie (Prerecord (Movie))

Prerecord (Movie) maintains a pre-recording of approximately five seconds of action (approximately two seconds for High Speed Movie). When you start real-time recording, the pre-recorded content is stored followed by the real-time recording, to help make sure you do not miss anything by being late pressing the record button.

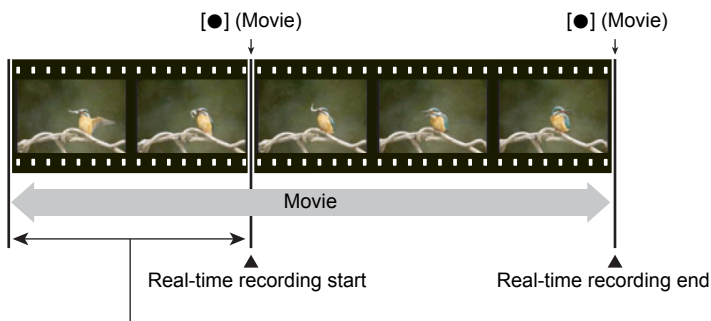

Approximately 5-second prerecorded part (from the buffer)

- Approximately two seconds for high speed movie

■ To set up the camera to shoot with Prerecord Movie

1. Align the mode dial with **[BS]** (BEST SHOT).
2. Press **[MENU]**.
3. Press **[◀]**, use **[▲]** and **[▼]** to select the “**REC MENU**” tab, and then press **[SET]**.
4. Use **[▲]** and **[▼]** to select “**Movie Quality**” and then press **[▶]**.
5. Use **[▲]** and **[▼]** to select the movie mode you want to use for shooting and then press **[SET]**.

6. Press [SET].

7. Use [▲] and [▼] to select , and then press [SET].

8. Use [▲], [▼], [◀], and [▶] to select the “Prerecord (Movie)” scene and then press [SET].

This causes  (Prerecord (Movie)) to appear on the monitor screen, indicating that the camera is prerecording to its buffer.

■ To shoot a Prerecord Movie

1. After using the above procedure to set up the camera for Prerecord Movie, point the camera at the subject.

2. When you are ready to record, press [●] (Movie).

This will save the approximately five seconds of action that was prerecorded in the buffer before you pressed [●] (Movie) (two seconds if you are using high speed movie) and start real-time recording.

3. Press [●] (Movie) again to stop recording.

- To turn off Prerecord Movie recording, align the mode dial with [P] (Program Auto) or [P] (Premium Auto PRO).
- When shooting with the high speed movie “HS30-120” and “HS30-240” setting, you cannot change the speed (fps) setting while the camera is pre-recording to the buffer in step 1 of the above procedure. You can change the speed (fps) setting after you press [●] (Movie) to start real-time recording.

NOTE

- While the camera is set up for shooting with Prerecord Movie, pressing the shutter button will not shoot a snapshot unless movie recording is in progress. With high-definition (FHD) and standard (STD) movie, you can shoot still images while realtime movie recording is in progress.
- When shooting with Prerecord Movie in combination with high speed movie, pressing the [◀] or [▶] key will not change the EV shift or white balance setting, even if “EV Shift” or “White Balance” is assigned for the “L/R Key” function. To change the EV shift or white balance setting in this case, use the Control Panel.

Recording a Movie for YouTube (For YouTube)

The “For YouTube” scene records movies in a format that is optimal for uploading to the YouTube movie site, which is operated by YouTube, LLC. “For YouTube” can be used when shooting a standard (STD) movie, a high-definition (FHD) movie, or a high speed (HS) movie.

1. Align the mode dial with **[BS]** (BEST SHOT).

2. Press **[MENU]**.

3. Press **[◀]**, use **[▲]** and **[▼]** to select the “**REC MENU**” tab, and then press **[SET]**.

4. Use **[▲]** and **[▼]** to select “Movie Quality” and then press **[▶]**.

5. Use **[▲]** and **[▼]** to select the movie mode you want to use for shooting and then press **[SET]**.

6. Press **[SET]**.

7. Use **[▲]** and **[▼]** to select **BS**, and then press **[SET]**.

8. Use **[▲]**, **[▼]**, **[◀]**, and **[▶]** to select the “For YouTube” scene and then press **[SET]**.

This causes  to appear on the monitor screen.

9. Record the movie.

The movie file will be stored in a camera folder named “100YOUTB”.

- Installing YouTube Uploader for CASIO simplifies uploading of movie files you recorded with the “For YouTube” scene to YouTube.
- To exit “For YouTube”, align the mode dial with **[P]** (Program Auto) or **[P+]** (Premium Auto PRO).

NOTE

- Movies recorded with the “For YouTube” scene are stored in a special folder to make them easy to locate for uploading (page 153). “For YouTube” movies are shot using the image size, recording speed, and quality settings configured in the Movie Mode (page 65).
- Snapshots cannot be shot (regardless of whether you are recording or not) while the “For YouTube” scene is selected.
- A single movie can have a maximum file size of 2,048MB or a playback time of 15 minutes. The actual maximum recording time depends on the movie mode used for recording (page 193).

Shooting a Snapshot while Shooting a Movie (Snapshot In Movie)

You can shoot snapshots while movie recording is in progress. When the camera is in the Single Shot mode, you can shoot snapshots one-by-one. In the CS mode, holding down the shutter button will record up to seven consecutive images at a speed of approximately 10 images per second (fps). You can shoot a maximum total of 28 images during a single movie recording operation.

1. While a movie is being recorded, press the shutter button.

- In the CS mode, images continue to be shot as long as you keep the shutter button depressed.
- Movie recording is not interrupted while snapshots are being shot.
- While movie recording is in progress, you can toggle between the Single Shot Mode and the CS mode by pressing [CS] (Continuous Shutter), [◀], [▶], or [SET]. Note that this method for mode switching is possible only during movie recording. The CS mode is indicated when [CS] is white (on the monitor screen), and the Single Shot mode is selected when [S] is white.



Number of recordable snapshots





NOTE

- Note that the flash cannot be used when shooting a Snapshot In Movie.
- Note that shooting a snapshot while shooting a movie is supported during FHD movie and STD movie recording only. It is not supported during other types of movie recording.
- Snapshots shot with Snapshot In Movie cannot be focused individually. The focus will be the same as the movie being recorded.
- The field of view of a snapshot shot while FHD movie recording is in progress will be wider than the field of view of the FHD movie.
- The snapshot image quality automatically changes to “Normal”.
- The P (Program Auto) recording mode is used when you shoot a snapshot during movie recording.

Using BEST SHOT

BEST SHOT provides you with a collection of sample “scenes” that show a variety of different types of shooting conditions. When you need to change the setup of the camera, simply find the scene that matches what you are trying to achieve, and the camera sets up for it automatically. This helps to minimize the chance of ruined images due to poor exposure and shutter speed settings.

■ Some Sample Scenes

			
Portrait	Scenery	High Speed Night Scene	High Speed Night Scene and Portrait

To shoot with BEST SHOT

1. Align the mode dial with **[BS]** (BEST SHOT).
2. Press **[SET]**.
3. Use **[▲]** and **[▼]** to select **BS**, and then press **[SET]**.
This will display a menu of BEST SHOT scenes.
4. Use **[▲]**, **[▼]**, **[◀]**, and **[▶]** to move the boundary to the scene you want to select.
 - You can scroll to another page of scenes by pressing **[▲]** or **[▼]**.
 - To return to normal snapshot recording, align the mode dial with **[P]** (Program Auto).

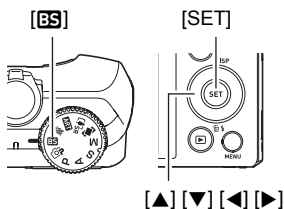

Currently selected scene (with boundary)



5. Press [SET] to configure the camera with the settings for the currently selected scene.

This returns to the REC mode.

- To select a different BEST SHOT scene, repeat the above procedure from step 1.

6. Press the shutter button (if you are shooting a snapshot) or [●] (Movie) (if you are shooting a movie).

■ Using the Scene Information Screen

To find out more about a scene, select it with the boundary on the scene menu and then rotate the zoom controller in either direction.

- To return to the scene menu, rotate the zoom controller again.
- To scroll between scenes, use [◀] and [▶].
- To configure the camera with the settings for the currently selected scene, press [SET].

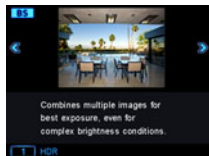

■ BEST SHOT Precautions

- Sample images shown on BEST SHOT scene screens were not shot with this camera. There are provided to illustrate the effects and merits of each scene.
- Images shot using a BEST SHOT scene may not produce the results you expected due to shooting conditions and other factors.
- You can modify the camera settings that are configured after you select a BEST SHOT scene. Note, however, that the BEST SHOT settings revert to their defaults when you select another BEST SHOT scene or turn off the camera.
- Snapshot shooting is disabled while the following BEST SHOT scenes are being used.

Prerecord (Movie), For YouTube

- Movie recording is disabled while the following BEST SHOT scenes are being used.
High Speed Best Selection, Lag Correction, High Speed Anti Shake, Wide Shot, High Speed Night Shot, Slide Panorama, Snapshot, HDMI TV Output
- When the movie mode is **FHD/STD**, movies are recorded using the settings of the selected BEST SHOT scene. For high speed movie recording, BEST SHOT scene settings are ignored and movie recording is performed as it normally is.
- BEST SHOT scenes that use High Speed CS ignore the “Zoom (SR)” setting.
- With the BEST SHOT scenes below, certain shooting conditions can cause the image area to become narrower than normal.
High Speed Night Scene and Portrait, High Speed Night Scene

Creating and Using Your Own Setups (CUSTOM SHOT)

You can register up to 999 setups, based on snapshots shot with the camera, as “CUSTOM SHOT” scenes. Selecting a registered “CUSTOM SHOT” scene configures the camera with its settings. The setups of snapshots recorded with the following modes and features can be registered as CUSTOM SHOT scenes.

- Program Auto
- A Mode
- S Mode
- M Mode
- BEST SHOT (Excluding “Prerecord (Movie)”, “For YouTube”, and “HDMI TV Output”)

■ To register a CUSTOM SHOT scene

1. On the BEST SHOT scene menu, select the scene named “CUSTOM SHOT (Register User Scene)” and then press [SET].

2. Use [◀] and [▶] to select the snapshot whose setup you want to save.

3. Use [▲] and [▼] to select “Save”, and then press [SET].

Your scene will be assigned the name “Custom Scene”, along with a scene number.

NOTE

- A movie setup cannot be registered as a CUSTOM SHOT scene.
- You can check the settings of the currently selected CUSTOM SHOT scene by displaying the camera’s setting menus and looking at its settings.
- CUSTOM SHOT scenes are assigned numbers in the sequence: U1, U2, and so on.
- The following are the settings that are saved for each CUSTOM SHOT scene. Face Detection, Focus, EV Shift, White Balance, Flash, ISO, Metering, Lighting, Flash Intensity, Sharpness, Saturation, Contrast
- CUSTOM SHOT scenes are stored in built-in memory (page 153) in the SCENE folder (snapshots).
- Formatting the camera’s built-in memory (page 165) deletes all user CUSTOM SHOT scenes.
- Use the following procedure when you want to delete a CUSTOM SHOT scene.
 - ① Display the information screen (page 75) of the user BEST SHOT scene you want to delete.
 - ② Press [▼] (), select “Clear”, and then press [SET].

■ To record with a registered CUSTOM SHOT scene

1. Align the mode dial with [BS] (BEST SHOT).

2. Press [SET].

3. Use [▲] and [▼] to select BS, and then press [SET].

4. Select the registered “Custom Scene”, and then press [SET].

5. Press the shutter button to shoot.

Digitally Correcting for Overexposure and Underexposure (HDR)

With HDR (High Dynamic Range), the camera shoots a series of CS images using different exposure settings and combines them into a final image to correct for overexposure or underexposure of subjects of different brightness levels.

1. Align the mode dial with [BS] (BEST SHOT).

2. Press [SET].

3. Use [▲] and [▼] to select BS, and then press [SET].

4. Select “HDR” and then press [SET].

5. Press [SET] and then use [▲] and [▼] to select the HDR (HDR Level) Control Panel option.

6. Use [◀] and [▶] to select the HDR Level setting you want, and then press [SET].
 - The HDR Level can be set to Level 1, Level 2, or Level 3.

7. Press the shutter button to shoot.

NOTE

- HDR works best when shooting with the camera mounted on a tripod.
- Shooting with this function causes the flash setting to change automatically to (Flash Off).
- Anti Shake correction performed to compensate for camera movement while shooting with this function results in an image area that is narrower than normal.
- The desired HDR effect may not be attained if the camera or subject moves during shooting.
- Depending on shooting conditions and image composition, this function may not be able to produce the desired result.

Shooting Bright Images in the Dark without Flash (High Speed Night Shot)

The camera shoots a series of images and then merges them into a final image. The result is a bright image, even if shot in the dark without a flash.



Shot with "Program Auto", without flash

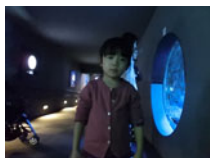

Shot with "High Speed Night Shot"

1. Align the mode dial with [BS] (BEST SHOT).

2. Press [SET].

3. Use [▲] and [▼] to select BS, and then press [SET].

4. Select "High Speed Night Shot" and then press [SET].

5. Press the shutter button to shoot.

- Take care to avoid camera movement and subject movement as you shoot.
- You should be able to see the subject(s) on the monitor screen when composing the image.

NOTE

- When shooting with this function, the "ISO Sensitivity" (page 45) becomes "Auto" (fixed).
- If camera movement occurs when shooting with this function, the anti-shake process will result in an image range that is narrower than normal.
- When shooting with this function, the 16M, 3:2, and 16:9 image size settings cannot be selected. If one of these sizes is selected in another mode, the image size will change to 10M when this function is selected.

Shooting with a Super Wide Angle of View (Wide Shot)

With this feature, a number of images are shot and then combined to produce an image with a super-wide angle of view that exceeds the widest angle of view possible with the lens. Converted to 35 mm equivalents, the focal distances available with this feature enable shooting with approximate angles of view of 14 mm and 18 mm.

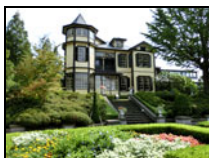

24 mm (lens widest angle)



18 mm



14 mm

1. Align the mode dial with **[BS]** (BEST SHOT).

2. Press **[SET]**.

3. Use **[▲]** and **[▼]** to select **BS**, and then press **[SET]**.

4. Select “Wide Shot” and then press **[SET]**.

5. Press **[SET]** and then use **[▲]** and **[▼]** to select the **WV** (Wide Level) Control Panel option.

6. Use **[◀]** and **[▶]** to select the width setting (angle of view) you want and then press **[SET]**.

There are two settings available: “18 mm” and “14 mm”.
“14 mm” shoots a wider area than “18 mm”.

7. Hold the camera so it is upright, with the shutter button and other controls at the bottom.

- Do not point the camera straight down at the ground at this time. If you do, the camera’s built-in vertical/horizontal position sensor will not operate properly and may make it impossible to start shooting.

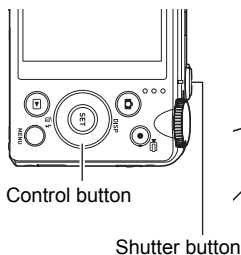

8. Point the camera at the subject you want in the center of the image and then half-press the shutter button to focus.

- The outer blue boundary on the screen indicates the recordable range of the image.

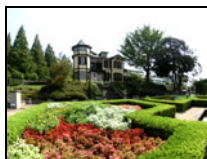

Desired image



Blue boundary

Center part at the start of the shooting operation

9. Press the shutter button the rest of the way down and slowly move the camera in accordance with the instructions and arrow that appear on the monitor screen.

- Holding the camera firmly with both hands, follow the instructions that appear on the monitor screen to slowly slide the camera horizontally or vertically at a constant speed in an arc centered on your body.
 - When sliding the camera horizontally, do not allow your body to move left or right. A vertical line running through your body should serve as the axis.
 - When sliding the camera vertically, do not allow your body to move upwards or downwards. A horizontal line between your shoulders should serve as the axis.
 - Take care not to slide the camera diagonally and be sure to maintain a firm grip on it.
- The camera will start composing the super-wide image internally when the slide cursor reached the other end of the movement range.
- Image composing also will start automatically if you stop moving the camera during super-wide shooting. After you stop moving the camera, the message “Busy... Please wait...” appears as the camera processes the image. Wait until this message disappears before using the camera. Image shooting is disabled while the message is displayed.

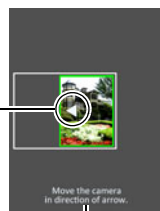

Instructions

Arrow

NOTE

- The “14 mm” and “18 mm” angle of view values are approximate and are provided for reference only. Actual angle of view values are not guaranteed.
- Zoom operations are not supported during Wide Shot shooting. The zoom setting is fixed at full wide angle.
- This function makes it possible to shoot images with a maximum angle of view of 14 mm or 18 mm. Note, however, that shooting conditions can result in a smaller angle of view.
- The following conditions are not compatible with Wide Shot shooting.
 - Subject whose brightness is very different from that of its surroundings due to artificial light, sunlight, etc.
 - Rivers, waves, waterfalls, or other subject with constantly changing patterns
 - Sky, beach, or other subject with continuous patterns
 - Camera too close to the main subject
 - Moving subject
 - Panning upwards on a skyscraper or some other very tall structure or object
 - Dark surroundings
- Any of the following can cause Wide Shot operation to stop part way through.
 - Subject or camera movement
 - Camera movement that is too fast or too slow
 - Camera movement outside of the required route
 - Camera movement in the wrong direction
- Shooting a Wide Shot image after half-pressing the shutter button to perform Auto Focus may not produce the desired results if there are considerable differences in the brightness, color, and/or focus of the individual images. If this happens, try changing the focus position by focusing on a different subject, etc.
- Since a Wide Shot image is created by joining multiple images together, there may be some roughness at the point where two images are joined.
- Shooting under a flickering light source (such as fluorescent lighting) may result in uneven brightness and/or coloring in the final Wide Shot image.
- The exposure and white balance when shooting Wide Shot images are fixed at the levels measured when you half-press the shutter button at the beginning of the operation.
- With this BEST SHOT scene, the flash setting automatically becomes  (Flash Off).

Shooting a Panorama Image (Slide Panorama)

With Slide Panorama, you move the camera to compose and record multiple images, which are then combined to a panorama. This feature lets you shoot a panorama of up to 360 degrees, which is dramatically greater than the physical capabilities of the lens.



- The final panorama image can be one of the two sizes shown below.
Slide Direction is Right or Left: Maximum 11520×1080 pixels
Slide Direction is Up or Down: Maximum 1920×7296 pixels
- Zoom operations are not supporting during Slide Panorama shooting. The zoom setting is fixed at full wide angle.
- You can use Slide Panorama to shoot a horizontal image up to approximately 360 degrees and a vertical image up to approximately 180 degrees.
If you shoot a horizontal Slide Panorama image that is less than 360 degrees, the image size will become 60, 120, 180, 240, or 300 degrees.

- 1. Align the mode dial with [BS] (BEST SHOT).**

- 2. Press [SET].**

- 3. Use [▲] and [▼] to select [BS], and then press [SET].**

- 4. Select “Slide Panorama” and then press [SET].**

- 5. Press [SET] and then use [▲] and [▼] to select the [Slide Direction] Control Panel option.**

- 6. Use [◀] and [▶] to select the direction you are planning to move the camera while shooting, and then press [SET].**
You can select one of four directions: Right, Left, Up, or Down.

- 7. Point the camera at the start of the panorama and half-press the shutter button to allow the camera to focus automatically.**

8. Press the shutter button the rest of the way down and a slide cursor will appear on the monitor screen. Slowly move the camera in the direction indicated by the arrow on the screen until the slide cursor reaches the other end of its movement range (i.e. all the way to the right when moving the camera to the right).

- The camera will start composing the panorama image internally when the slide cursor reached the other end of the movement range.
- Image composing also will start automatically if you stop moving the camera during panorama shooting. After you stop moving the camera, the message "Busy... Please wait..." appears as the camera processes the image. Wait until this message disappears before using the camera. Image shooting is disabled while the message is displayed.

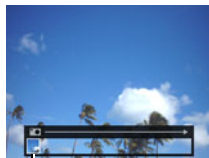

Slide cursor

NOTE

- The following conditions are not compatible with Slide Panorama shooting.
 - Subject whose brightness is very different from that of its surroundings due to artificial light, sunlight, etc.
 - Rivers, waves, waterfalls, or other subject with constantly changing patterns
 - Sky, beach, or other subject with continuous patterns
 - Camera too close to the main subject
 - Moving subject
 - Dark surroundings
- Slide Panorama may stop part way through in the following cases.
 - Subject or camera movement
 - Camera movement that is too fast or too slow
- Shooting a Slide Panorama image after half-pressing the shutter button to perform Auto Focus may not produce the desired results if there are considerable differences in the brightness, color, and/or focus of the individual images. If this happens, try changing the focus position by focusing on a different subject, etc.
- Since a Slide Panorama image is created by joining multiple images together, there may be some roughness at the point where two images are joined.
- Shooting under a flickering light source (such as fluorescent lighting) may result in uneven brightness and/or coloring in the final Slide Panorama image.
- The exposure and white balance when shooting Slide Panorama images are fixed at the levels measured when you half-press the shutter button at the beginning of the operation.
- Shooting with this function causes the flash setting to change automatically to  (Flash Off).

Shooting with Priority on Subject Faces (High Speed Best Selection)

With High Speed Best Selection, the camera automatically shoots a series of images, and selects the best one based on facial image blur, and facial expression (whether the subject is smiling or blinking).

1. Align the mode dial with **[BS] (BEST SHOT)**.

2. Press **[SET]**.

3. Use **[▲]** and **[▼]** to select **BS**, and then press **[SET]**.

4. Select “High Speed Best Selection” and then press **[SET]**.

5. Press the shutter button to shoot.
 - This will cause the message “Busy... Please wait...” to appear. Do not move the camera while this message is displayed. The recording process takes some time to complete after the message appears.

NOTE

- Shooting with this function causes the flash setting to change automatically to **[Flash Off]** (Flash Off).
- If one or more of the faces are blurred in all of the images that are shot, they will be blurred in the final image as well.
- The following conditions may make it impossible for the camera to determine if the subject is blinking or smiling. This may result in a final image in which the subject is blinking or not smiling.
 - Faces that are partially or completely darkened by shadows, etc.
 - Hair that is hiding or near the eyes
 - Eye glasses
 - Small faces
 - Faces that are not looking directly at the camera
- Shooting a large group of people will cause processing of the image after shooting to take longer.

Configuring the Camera to Help You Better Time Your Shots (Lag Correction)

There always is some unavoidable time lag between the point you press the shutter button and the point that the image is actually recorded. The “Lag Correction” feature lets you configure the camera to lessen or even eliminate this lag to help you better time your shots and get exactly the moment you want. With “Lag Correction”, you half-press the shutter button and compose the image you want to shoot. Then when you full-press the shutter button, the camera pre-records a total of 5 images, including four images of action that happened before you fully pressed the shutter button. After that, you can view the images on the monitor screen and select the one you want to keep.

- 1. Align the mode dial with [BS] (BEST SHOT).**

- 2. Press [SET].**

- 3. Use [▲] and [▼] to select BS, and then press [SET].**

- 4. Select “Lag Correction” and then press [SET].**

- 5. With the camera pointed at the subject, half-press and hold the shutter button.**

The camera will start pre-recording images at this time.

 - If you release the half-pressed shutter button before pressing it the rest of the way down, all of the pre-recorded images currently in the buffer will be deleted.

- 6. When you are ready to shoot, press the shutter button all the way down.**

After pre-recording is complete, one of the five images will appear on the monitor screen for about three seconds.

- 7. If you want to view all five of the pre-recorded images, press [SET] within about three seconds after a recorded image appears on the monitor screen.**

If you do not press [SET] within three seconds, the image displayed in step 6 will be saved automatically as the final image.

8. Use [◀] and [▶] to scroll through the pre-recorded images on the monitor screen.

Use [◀] and [▶] to scroll through the pre-recorded images. Each image appears, along with an indication of the timing when it was pre-recorded.

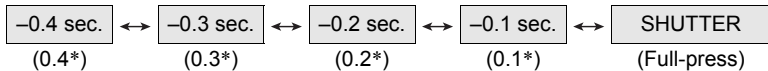

* Seconds prior to full-press of shutter button.

- The timing of the image you select here will be the timing of the image displayed first in step 6 the next time you perform the above procedure. If you select the image that was pre-recorded 0.3 seconds prior to full-press of the shutter button, for example, the -0.3-second image will be displayed in step 6 the next time you perform the above procedure.

9. To save the currently displayed image as the final images, press [SET].

NOTE

- With this BEST SHOT scene, the flash setting automatically becomes  (Flash Off).
- The Self-timer cannot be used with this BEST SHOT scene.
- With this BEST SHOT scene, half-pressing the shutter button fixes focus and exposure at their current levels.
- With this BEST SHOT scene, image recording will not be successful if you full-press the shutter button without allowing enough time (at least 0.4 seconds) after half-pressing it.
- Pay close attention to the subject when shooting. Failure to do so can cause considerable lag from the instant you want to shoot until you actually full-press the shutter button. This can cause image recording to be too late, even if you use this function.
- The current “Review” setting (page 107) is ignored when shooting with this function. Immediately after you full-press the shutter button, one of the five pre-recorded images will appear on the display as in step 4 of the above procedure.

Using Continuous Shutter with Auto Focus (AF-CS)

AF-CS shoots up to 30 CS images while keeping the subject in focus. This feature comes in handy when shooting children and other fast-moving subjects. The CS speed is automatically adjusted in accordance with shooting conditions within the range of three to six frames per second.

1. Align the mode dial with **[BS]** (BEST SHOT).
2. Press **[SET]**.
3. Use **[▲]** and **[▼]** to select **BS**, and then press **[SET]**.
4. Select “AF-CS” and then press **[SET]**.
5. Press the shutter button the rest of the way down.

Hold down the shutter button to shoot up to 30 images at high speed.

NOTE

- Zoom is disabled during continuous shutter operations.
- The following image sizes cannot be selected while shooting with Auto Focus CS: 3:2, 16:9. If select AF-CS while either of these image sizes is selected, the camera will automatically switch the images size setting to 16M.
- The following camera features cannot be used while shooting with Auto Focus CS: Triple Self-timer, Single SR Zoom.
- The settings in the table below are fixed while shooting with AF-CS.

Image Quality	Normal
Flash	Flash Off
Focus Mode	AF
AF Area	Spot

Shooting with High Speed Anti Shake (High Speed Anti Shake)

When you press the shutter button while High Speed Anti Shake is enabled, the camera records multiple images and automatically combines them in a way that produces a final image with minimal blur. You can shoot with this feature to minimize the effects of camera movement when shooting with optical Anti Shake does not produce the desired results.

1. In the REC mode, set the mode dial to [BS] (BEST SHOT).

2. Press [SET].

3. Select “High Speed Anti Shake” and then press [SET].

4. When you are ready to shoot, press the shutter button.

NOTE

- With this BEST SHOT scene, the flash setting automatically becomes  (Flash Off).
- High Speed Anti Shake may not operate properly resulting in blurred images if the camera is moved more than the allowable range or if the subject moves during shooting.
- When shooting with these BEST SHOT scenes, the “ISO Sensitivity” (page 45) and “ISO High Limit” (page 98) are fixed at “Auto”, and shooting is performed at a maximum of ISO 12800.

Shooting Snapshots (Snapshot)

This function adjusts exposure and shoots whenever the shutter button is half-pressed. This helps to ensure that you don't miss the shots you want. This feature comes in handy for daily shooting and when shooting natural scenery.

1. Align the mode dial with **[BS]** (BEST SHOT).

2. Press **[SET]**.

3. Use **[▲]** and **[▼]** to select **BS**, and then press **[SET]**.

4. Select "Snapshot" and then press **[SET]**.

5. Half-press the shutter button.

This will adjust exposure and shoot the snapshot.

- This will cause a pan focus distance value (PF -○.○m-) to appear in the upper left corner of the display. Everything from this distance and further will be in focus.

NOTE

- The focus frame will not appear for this type of shot.
- The settings below are fixed while shooting with this function.

Focus Mode	Pan Focus
ISO Sensitivity	Auto
Make-up Level	0 (Off)
Flash	Flash Off

- An image shot with this function can be zoomed up to 2X.
- Proper focusing may not be possible if the camera is too close to the subject, or if the camera is subjected to vibration or impact.

Using a TV Screen to Shoot Snapshots (HDMI TV Output)

Use the procedure below to configure the camera for shooting snapshots with an aspect ratio of 16:9, as you compose them on a TV screen.

- 1. Turn off the camera and use a commercially available HDMI cable to connect the camera to a TV.**

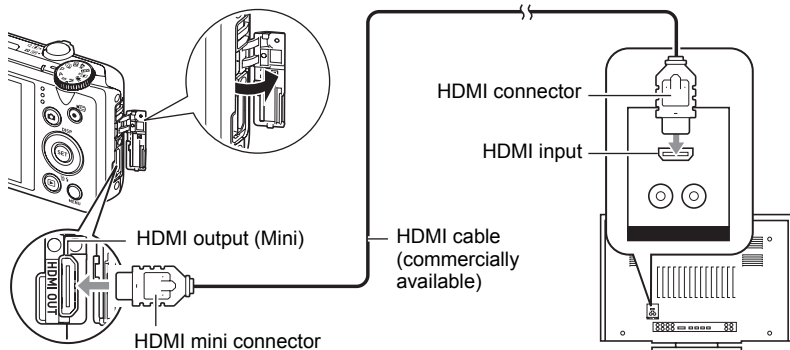

-
- 2. Turn on the camera.**

-
- 3. Align the Mode Dial with [BS] (BEST SHOT).**

-
- 4. Press [SET].**

-
- 5. Use [▲] and [▼] to select BS and then press [SET].**

-
- 6. Select “HDMI TV Output” and then press [SET].**

This will turn off the camera's monitor screen and display an image composition screen on the connected TV.

-
- 7. Compose the image on the TV screen and press the shutter button to shoot.**

NOTE

- For details about connecting to the camera and precautions when connecting, see page 118.
- If you want to change the digital video signal format, first unplug the HDMI cable from the camera (page 119).
- The settings in the table below are fixed while shooting with this function.

Image Size	16:9
AF Area	Spot
Continuous AF	Off
Face Detection	Off
Make-up Level	0 (Off)
White Balance	Auto WB
Metering	Multi

Advanced Settings (REC MENU)

The following are menu operations you can use to configure various camera settings.

- You also can use the Control Panel (page 38) to configure some of the settings that appear on the menu screen. Refer to the page references provided in this section for information about configuring settings using the Control Panel.

Configuring Recording Settings

■ Example Menu Screen Operation

1. In the REC mode, press [MENU].

This will display the menu screen (📷 REC MENU).

- Menu contents are different in the REC mode (📷 REC MENU) and PLAY mode (▶ PLAY MENU).

2. Press [◀], use [▲] and [▼] to select the tab where the menu item you want to configure is located, and then press [▶].

3. Use [▲] and [▼] to select the menu item you want, and then press [▶].

- Operating the zoom controller displays the next page of menu items.

4. Use [▲] and [▼] to change the setting of the selected menu item.

- In the case of the menu items below, use [◀] and [▶] to select the setting you want.
Make-up Level, EV Shift, White Balance

5. After the setting is the way you want, press [SET] to apply the setting and return to the viewfinder screen.

- Pressing [MENU] cancels the current selections and returns to the menu screen.
- To display a different tab, press [MENU] to move the blue boundary to the menu item and then press [◀]. Next use [▲] and [▼] to select the tab you want, and then press [▶].
- Pressing [📷] (Continuous Shutter) interrupts the menu operation and exits the menu screen.

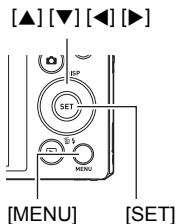

Example:
When “Self-timer” is selected on the “📷 REC MENU” tab

Tabs



NOTE

- Depending on the recording mode, some of the items on the menu that appears may not be usable.

■ Menu Operations in This Manual

Menu operations are represented in this manual as shown below. The following operation is the same as the one described under “Example Menu Screen Operation” on page 92.

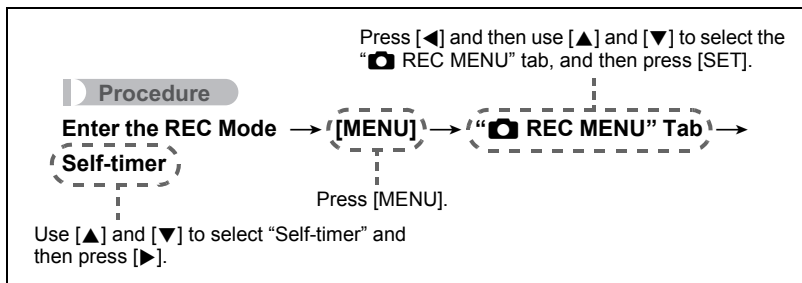

Assigning Functions to the [◀] and [▶] Keys (L/R Key)

Procedure

Enter the REC Mode → [MENU] → “REC MENU” Tab → L/R Key

You can select from among the functions described below and assign one to the [◀] and [▶] keys (Key Customize). After you do, you can select either of the functions by pressing the [◀] or [▶] key.

Setting	[◀]/[▶] key operation
AF → → → →	Selecting a Focus Mode (page 42) • “MF” (Manual Focus) cannot be selected.
AF Area	Specifying the Auto Focus Area (page 99)
Metering	Changes the Metering Mode (page 104)
Self-timer	Sets the self-timer time (page 39).
ISO	Changes the ISO Sensitivity setting (page 45).
White Balance	Changes the white balance setting (page 40).
EV Shift	Adjusts the EV shift value (page 47).
Off	Cancels [◀] and [▶] key assignments

Saving a Second Normal Image When Shooting With HDR Art (Double (HDR ART))

Procedure







Enter the REC Mode → [MENU] → “ REC MENU” Tab → Double (HDR Art)

See page 63 for details.

To select the snapshot image size (Image Size)

Procedure

Enter the REC Mode → [MENU] → “ REC MENU” Tab → Image Size

Image Size (Pixels)	REC Screen Icon Display	Suggested Print Size and Application	Description
16M (4608×3456)		Poster Print	Good detail for better clarity even for images cropped (page 130) from the original
3:2 (4608×3072)		Poster Print	
16:9 (4608×2592)		HDTV	
10M (3648×2736)		Poster Print	Good detail
5M (2560×1920)		A4 Print	
3M (2048×1536)		3.5"×5" Print	Best when preserving memory capacity is relatively more important than image quality.
VGA (640×480)		E-Mail	Image files are smaller, which is better when attaching images to e-mail. However, images are relatively coarser.

- The initial factory default image size setting is “16M”.
- Selecting “3:2” records images with an aspect ratio of 3:2, which matches the standard aspect ratio of print paper.
- The letters “HDTV” stand for “High Definition Television”. An HDTV screen has an aspect ratio of 16:9, which makes them wider than the usual 4:3 aspect ratio of television screens of the past. Your camera can record images that are compatible with the aspect ratio an HDTV screen.

- You should regard the print paper sizes suggested here as guidelines only (200 dpi print resolution).
- Available image sizes are limited for some functions as noted below.

16M	This image size cannot be selected when using “High Speed Night Shot”. Selecting “16M” in another mode and then switching to “High Speed Night Shot” will cause the image size to change to “10M” automatically.
3:2, 16:9	These image sizes cannot be selected when using “High Speed CS” or “High Speed Night Shot”. Selecting “3:2” or “16:9” in another mode and then switching to “High Speed CS” will cause the image size to change to “16M” automatically. In the case of “High Speed Night Shot”, the image size will change to “10M” automatically.

■ Pixels and image size

A digital camera image is a collection of small dots called “pixels”. The more pixels there are in an image, the more detail there will be. However, you generally can do with fewer pixels when printing an image (L size) through a print service, attaching an image to e-mail, when viewing the image on a computer, etc. The size of an image indicates how many pixels it contains, and is expressed as horizontal pixels×vertical pixels.

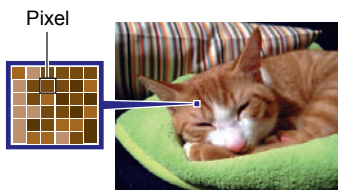

Example:



Image size	Pixels
16M	4608×3456 (Approximately 16 million pixels)
3M	2048×1536 (Approximately 3 million pixels)

- Note that larger images have more pixels, so they take up more memory space.
- For information about image size, image quality, and number of images that can be stored, see page 191.
- For information about movie image size, see page 96.
- For information about resizing existing snapshots, see page 130.

Specifying Snapshot Image Quality (Image Quality)

Procedure

Enter the REC Mode → [MENU] → “ REC MENU” Tab → Image Quality

Setting	REC Screen Icon Display	Description
Fine		Gives image quality priority.
Normal		Normal



- The “Fine” setting helps to bring out details when shooting a finely detailed image of nature that includes dense tree branches or leaves, or an image of a complex pattern.
- Memory capacity (the number of images you can record) will be affected by the quality settings you configure (page 191).







Movie Image Quality Settings (Movie Quality)

Procedure

Enter the REC Mode → [MENU] → “ REC MENU” Tab → Movie Quality

This setting can be used to configure movie image quality settings and to select either normal movie recording or High Speed Movie recording.

Settings (Quality (pixels))	REC Screen Icon Display	Approximate Data Rate (Frame Rate)	Description
FHD		14.2 Megabits/second (30 frames/second)	Select this setting record high-definition (FHD) movies (page 68). The aspect ratio of movies recorded with this setting is 16:9.
HD		10.9 Megabits/second (15, 20, 30 frames/second)	Select this setting record high-definition (HD) movies. The aspect ratio of movies recorded with this setting is 16:9. <ul style="list-style-type: none">• “HD” appears in place of “FHD” only when you are shooting with ART SHOT (page 61). The frame rate depends on the ART SHOT scene type.

Settings (Quality (pixels))	REC Screen Icon Display	Approximate Data Rate (Frame Rate)	Description
STD		3.9 Megabits/second (30 frames/second)	Use this setting for standard movie recording. Recording with this setting is performed using an aspect ratio of 4:3. The image size of movies recorded with this mode depends on the frame rate (recording speed (page 68)).
HS1000		40.0 Megabits/second (1000 frames/second)	
HS480		40.0 Megabits/second (480 frames/second)	
HS240		40.0 Megabits/second (240 frames/second)	
HS120		40.0 Megabits/second (120 frames/second)	
HS30-240		5.4 Megabits/second (30 frames/second) 40.4 Megabits/second (240 frames/second)	
HS30-120		10.4 Megabits/second (30 frames/second) 40.4 Megabits/second (120 frames/second)	

Specifying ISO Sensitivity (ISO)

Procedure





Enter the REC Mode → [MENU] → “ REC MENU” Tab → ISO

For details, see the Control Panel procedure on page 45.

Specifying the ISO Sensitivity Upper Limit (ISO High Limit)

Procedure

Enter the REC Mode → [MENU] → “ REC MENU” Tab → ISO High Limit

Settings	REC Screen Icon Display	Description
Auto	None	Shoots using the ISO sensitivity setting specified by the “ISO Sensitivity” setting (page 45).
ISO 200		The setting selected here becomes the ISO sensitivity upper limit when “Auto” is selected for the “ISO Sensitivity” setting (page 45).
ISO 400		
ISO 800		
ISO 1600		
ISO 3200		

NOTE

- When the “ISO Sensitivity” setting (page 45) is something other than “Auto”, the “ISO High Limit” setting is ignored, and shooting is performed using the option selected for the “ISO Sensitivity” setting.
- The settings available for “ISO High Limit” become as shown below when shooting with “High Speed Night Scene” (page 78).
Auto, ISO 1600, ISO 3200, ISO 6400, ISO 12800, ISO 25600
- The “ISO High Limit” setting cannot be configured while any one of the BEST SHOT scenes below is in use.
Premium Auto PRO, M mode, some BEST SHOT scenes
- The “ISO 3200” setting cannot be selected while the Multi SR Zoom REC mode is selected. If “ISO 3200” is selected in another REC mode, switching to Multi SR Zoom causes the REC mode to change to “ISO 1600”.

Zooming with Super Resolution (Zoom (SR))

Procedure

Enter the REC Mode → [MENU] → “📷 REC MENU” Tab → Zoom (SR)
See page 54 for details.





Specifying the Auto Focus Area (AF Area)

Procedure

Enter the REC Mode → [MENU] → “📷 REC MENU” Tab → AF Area

You can use the following procedure to change the Auto Focus metering area for shooting snapshots.

- When recording movies, the AF metering area is always “📷 Spot”.

Settings	Description
 Intelligent	The camera automatically determines the focus point on the screen and focuses there (intelligent AF). <ul style="list-style-type: none">• Face detection (page 102) operates automatically.
 Spot	This mode takes readings of a small area in the center of the image. This setting works well with focus lock (page 44).
 Multi	When you half-press the shutter button while this setting selected, the camera will select the optimum Auto Focus area from among nine possible areas. The focus frame of the area where the camera focuses will be displayed in green.
 Tracking	When you half-press the shutter button while this setting is selected, the focus frame will follow the movement of the subject.

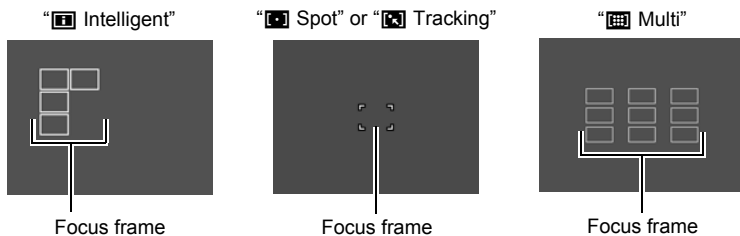

- Auto Focus is disabled when “MF” (Manual Focus) is selected for the focus mode (page 42), even if you select an AF area.



- With some BEST SHOT scenes, there are restrictions on the use of AF area settings. Because of this, you may not be able to use certain settings or you may not be able to specify any AF Area setting.
- While Face Detection (page 102) is turned on, regardless of the current AF Area setting, "[Spot] Spot" (center) focusing will be used automatically whenever a face cannot be detected for some reason.

Reducing the Effects of Camera and Subject Movement (Anti Shake)

Procedure

Enter the REC Mode → [MENU] → "REC MENU" Tab → Anti Shake

You can turn on the camera's Anti Shake feature to reduce image blur due to subject movement or camera movement when shooting a moving subject using telephoto, when shooting a fast-moving subject, or when shooting under dim lighting conditions.

Settings	REC Screen Icon Display	Description
Strong		High-level Anti Shake processing that minimizes the effects of hand and subject movement. This setting can be used while the recording mode is Program Auto (except for High Speed CS) or High Speed Anti Shake.
Standard		Dramatically reduces the effects of hand and subject movement.
Off	None	Turns off Anti Shake settings.
DEMO		Half-pressing the shutter button demonstrates the effect of Anti Shake. However, the image is not recorded.

NOTE

- Only camera shake correction can be used during FHD and STD movie recording.
- Anti Shake correction is not supported during High Speed Movie or HDR Art Movie recording.
- When Anti Shake is enabled and “Auto” is selected for “ISO” (page 45), ISO sensitivity, aperture, and shutter speed will not appear on the monitor screen when you half-press the shutter button. These values will appear in the display of the image immediately after it is shot.
- Shooting with Anti Shake enabled can cause an image to appear somewhat coarser than normal and can cause slight deterioration of image resolution.
- Anti Shake may not be able to eliminate the effects of camera or subject movement when movement is severe.
- Anti Shake may not work properly when the camera is mounted on a tripod. Turn off Anti Shake.
- Even if “Strong” is selected for the Anti Shake setting, the “Standard” setting is used automatically whenever any setting other than “Auto” is selected for the “ISO High Limit” setting.
- Even if “Strong” is selected for the Anti Shake setting, some shooting conditions may make it impossible to achieve the desired Anti Shake results.

Optimizing Image Brightness (Lighting)

Procedure

Enter the REC Mode → [MENU] → “ REC MENU” Tab → Lighting

You can use this setting to optimize the balance between bright areas and dark areas when shooting images.

Settings	Description
On	Performs brightness correction. When this option is selected, it takes longer for the image to be stored after the shutter button is pressed.
Off	Does not perform brightness correction.

Shooting with Continuous Auto Focus (Continuous AF)

Procedure

Enter the REC Mode → [MENU] → “📷 REC MENU” Tab → Continuous AF

When shooting a snapshot while “On” is selected for Continuous AF, Auto Focus is performed and focusing is continually updated until you half-press the shutter button.

- Before you half-press the shutter button, the camera focuses at the center of the screen.

Shooting with Face Detection (Face Detection)

Procedure

Enter the REC Mode → [MENU] → “📷 REC MENU” Tab → Face Detection

When shooting people, the face detection feature detects the faces of up to ten individuals and adjusts focus and brightness accordingly.

1. Use [▲] and [▼] to select “On” and then press [SET].

2. Point the camera at the subject(s).

The camera will detect human faces and display a frame around each one.



3. Half-press the shutter button.

The camera will focus and the frames around the faces it focuses on will turn green.

4. Press the shutter button the rest of the way down.

Tips for Best Face Detection Results

- The camera performs center focus if it cannot detect a face.
- Always make sure that Auto Focus (AF) is selected as the focus mode when shooting with face detection.
- Detection of the following types of faces is not supported.
 - A face that is obstructed by hair, sunglasses, a hat, etc., or a face in dark shade
 - A profile or a face that is at an angle
 - A face that is very far away and small, or very close and large
 - A face in an area that is very dark
 - A face of a pet or some other non-human subject

IMPORTANT!

- Face detection cannot be used in combination with any of the following features.
 - Some BEST SHOT scenes
 - Movie Mode (Including some BEST SHOT scenes that support High Speed Movie recording)
 - High Speed CS with Prerecord CS (Including some BEST SHOT scenes that support High Speed CS recording)
- The “Focus” setting is always fixed at “AF” (Auto Focus) whenever “Face Detection” is being used. If you want to change the “Focus” setting, first select “Off” for “Face Detection”.

Turning Digital Zoom On or Off (Digital Zoom)

Procedure

Enter the REC Mode → [MENU] → “ REC MENU” Tab → **Digital Zoom**

Select “On” when you want to use digital zoom (page 51).

- Digital zoom is disabled while shooting with the following feature.
 - High speed movie recording, Some BEST SHOT scenes

Reducing Wind Noise during Movie Recording (Wind Noise Cut)

Procedure

Enter the REC Mode → [MENU] → “ REC MENU” Tab → **Wind Noise Cut**

Select “On” to reduce wind noise during movie recording. Note, however, that this will also cause the sound quality to change.

Recording Beautiful Portraits (Make-up Level)

Procedure

Enter the REC Mode → [MENU] → “ REC MENU” Tab → **Make-up Level**

For details, see the Control Panel procedure on page 46.

Correcting Image Brightness (EV Shift)

Procedure

Enter the REC Mode → [MENU] → “ REC MENU” Tab → EV Shift

For details, see the Control Panel procedure on page 47.

Adjusting White Balance (White Balance)

Procedure

Enter the REC Mode → [MENU] → “ REC MENU” Tab → White Balance

For details, see the Control Panel procedure on page 40.

Selecting a Focus Mode (Focus)

Procedure

Enter the REC Mode → [MENU] → “ REC MENU” Tab → Focus

For details, see the Control Panel procedure on page 42.

Using the Self-timer (Self-timer)

Procedure

Enter the REC Mode → [MENU] → “ REC MENU” Tab → Self-timer

For details, see the Control Panel procedure on page 39.

Specifying the Metering Mode (Metering)

Procedure

Enter the REC Mode → [MENU] → “ REC MENU” Tab → Metering

For details, see the Control Panel procedure on page 50.

Specifying Flash Intensity (Flash Intensity)

Procedure

Enter the REC Mode → [MENU] → “📷 REC MENU” Tab → Flash Intensity

You can specify flash intensity to one of five levels from +2 (brightest flash) to -2 (least bright flash).

- Flash intensity may not change when the subject is too far away or too close.

Controlling Image Sharpness (Sharpness)

Procedure

Enter the REC Mode → [MENU] → “📷 REC MENU” Tab → Sharpness

You can specify one of five sharpness settings from +2 (sharpest) to -2 (least sharp).

Controlling Color Saturation (Saturation)

Procedure

Enter the REC Mode → [MENU] → “📷 REC MENU” Tab → Saturation

You can specify one of five saturation settings from +2 (most saturated) to -2 (least saturated).

Adjusting Image Contrast (Contrast)

Procedure

Enter the REC Mode → [MENU] → “📷 REC MENU” Tab → Contrast

You can specify one of five contrast settings from +2 (most contrast between light and dark) to -2 (least contrast between light and dark).

Using the Auto Focus Assist Light (AF Assist Light)

Procedure

Enter the REC Mode → [MENU] → “ REC MENU” Tab → AF Assist Light

Half-pressing the shutter button while this setting is selected causes the front lamp to light, which provides illumination for focusing in areas where lighting is dim. Leaving this function turned off is recommended when shooting portraits from short distances, etc.

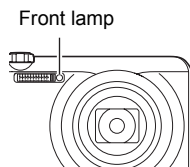

IMPORTANT!

- Never look directly into the front lamp while it is lit.
- Make sure your finger is not covering the front lamp.

Displaying the On-screen Grid (Grid)

Procedure

Enter the REC Mode → [MENU] → “ REC MENU” Tab → Grid

The on-screen grid can be displayed on the REC mode monitor screen for easy vertical and horizontal alignment when composing images.

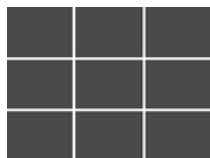

Turning on Image Review (Review)

Procedure

Enter the REC Mode → [MENU] → “ REC MENU” Tab → Review

While Review is turned on, the camera will display an image for about one second immediately after it is recorded.

Type 1	Displays a full-screen view of the image.
Type 2, Type 3	Displays a partial-screen view of the image. The difference between Type 2 and Type 3 is the way the image appears on the display.
Off	Turns off review image display

- When shooting with some functions while “Type 1” is selected for “Review” will cause the message “Busy... Please wait...” to appear after you press the shutter button. Shooting another image is disabled while this message is displayed. Wait a while until the process being performed is complete.
- The Review image may not appear when shooting with some recording modes.
- When shooting with “High Speed CS”, “AF-CS”, or “Triple Shot”, the Review image is displayed as “Type 2” if “Type 1” is selected as the Review image type.
- Shooting an “ART SHOT” image while “On” is selected for the “Double (HDR Art)” setting and Review is enabled will cause both the “ART SHOT” image and the normal image to be displayed as the Review image.

Using Icon Help (Icon Help)

Procedure

Enter the REC Mode → [MENU] → “ REC MENU” Tab → Icon Help

While Icon Help is turned on, a textual description will appear on the display for certain icons when you switch between REC functions.

Functions Supported by Icon Help

- Recording mode
- Available options for the “L/R Key” setting
- Exposure warning when shutter button is half-pressed

Configuring Power On Default Settings (Memory)

Procedure

Enter the REC Mode → [MENU] → “ REC MENU” Tab → Memory

This setting lets you specify which camera settings should be remembered by the camera when it is turned off, and restored the next time the camera is turned on. To have the camera remember a setting, you should enable the setting's memory. Any setting whose memory is disabled will be reset to its initial default any time the camera is turned off.

Setting	Disabled (Initial Default Setting)	Enabled
High Speed CS	Off	Setting at power off
Flash	Auto	
Focus	AF	
ISO	Auto	
White Balance	Auto WB	
EV Shift	0.0	
AF Area	Spot	
Metering	Multi	
Self-timer	Off	
Flash Intensity	0	
Zoom (SR)	Single	
Digital Zoom	On	
MF Position	Position before manual focus was selected.	
Zoom Position*	Full wide	

* Optical zoom setting only.

Viewing Snapshots and Movies

Viewing Snapshots

See page 32 for the procedure for viewing snapshots.

Viewing a Movie

1. Press [▶] (PLAY) and then use [◀] and [▶] to display the movie you want to view.
2. Press [SET] to start playback.

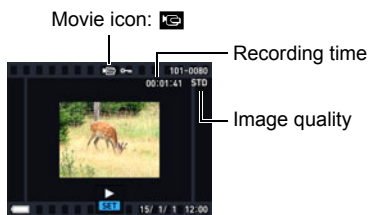

Movie Playback Controls

Fast forward/fast reverse	[◀] [▶] (Playback in progress.) <ul style="list-style-type: none">• Each press of either button increases the speed of the fast forward or fast reverse operation.• To return to normal playback speed, press [▼].
Play/pause	[SET]
1 frame forward/back	[◀] [▶] (Playback paused.) <ul style="list-style-type: none">• Holding down either button scrolls continuously.
Volume adjustment	Press [▼] and then press [▲] [▼] <ul style="list-style-type: none">• Volume can be adjusted only while movie playback is in progress.
Information display on/off	[▲] (DISP)
Change to normal playback speed during high speed movie playback	[●] (Movie) <ul style="list-style-type: none">• Press [●] (Movie) again to return to the slow playback speed. This operation is not supported when playing a movie shot with "HS30-120" or "HS30-240".
Zoom	Rotate the zoom controller in the direction of [⏏] (Q). <ul style="list-style-type: none">• You can use [▲], [▼], [◀], and [▶] to scroll the zoomed image on the monitor screen. You can zoom a movie image up to 4.5 times normal size.
Stop playback	[MENU]

- Playback may not be possible for movies not recorded with this camera.

- A movie that has been rotated using “Rotation” (page 129) or “Auto Rotate” (page 158) cannot be zoomed.

Viewing a Panorama Image

1. Press [▶] (PLAY), and then use [◀] and [▶] to display the panorama images you want to view.



2. Press [SET] to start playback of the panorama.

Panorama playback causes the image to scroll left, right, up, or down.

Playback Controls

To start or pause playback	[SET]
To advance scroll while paused	[◀] [▶] (When the slide direction is left or right.) [▲] [▼] (When the slide direction is up or down.) • Holding down any button scrolls continuously.
To hide or show display information	[▲] (DISP)
To stop playback	[MENU]

- The following functions cannot be performed on a panorama image.
MOTION PRINT, Movie Editing, Trimming, Resize, Lighting, White Balance, Brightness, Rotation

Viewing Continuous Shutter Images

Each time you perform a continuous shutter (CS) operation, the camera creates a CS group that includes all of the images for that particular CS session. You can use the following procedure to play back the images in a particular CS group.

1. Press [▶] (PLAY) and then use [◀] and [▶] to display the CS group whose images you want to view.

Number of image files in the CS group

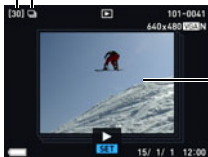

CS group icon

First image in the CS group

2. About one second after you select a CS group, high speed playback of its images will start automatically.

- After playback of a CS Group is complete, the first image of the group will be displayed on the monitor screen.
- Pressing [SET] will pause playback. While playback is paused, you can adjust the playback speed, specify the playback direction, scroll forward or back, zoom images, and delete images.

Current image number/number of images in the group





CS speed*

Playback guide

* Displayed when the image was shot using "High Speed CS".

The following are operations that are supported after you press [SET] to start image playback.

[◀] [▶]	During playback, changes the playback direction and playback speed. While playback is paused, scrolls forward or back. <ul style="list-style-type: none">• Playback speed cannot be adjusted while the displayed image is zoomed.
[SET]	Toggles between pause and play.
Zoom controller	Zooms the image. <ul style="list-style-type: none">• You can use [▲], [▼], [◀], and [▶] to scroll the zoomed image on the monitor screen.• Rotating the zoom controller towards  () while an image is not zoomed will display a menu of images in the current CS group.
[MENU]	Exits CS group playback.
[▲] (DISP)	Cycles through information display formats.
[▼]	Displays the “CS Frame Edit” menu.

Deleting Continuous Shutter Images

You can use the following procedures to delete images while playback is in progress or paused.

■ Deleting a Specific CS Group File

1. While CS image playback is in progress or paused (toggle by pressing [SET]), press [▼].

This will display the “CS Frame Edit” menu.

2. Use [▲] and [▼] to select “Delete” and then press [SET].

3. Use [◀] and [▶] to display the image you want to delete.

4. Use [▲] and [▼] to select “Delete” and then press [SET].

- To delete other files, repeat steps 3 and 4.
- To exit the delete operation, press [MENU].

■ Deleting Multiple Files in a CS Group

1. While CS image playback is in progress or paused (toggle by pressing [SET]), press [▼].

This will display the “CS Frame Edit” menu.

2. Use [▲] and [▼] to select “Delete” and then press [SET].
-

3. Use [▲] and [▼] to select “Delete Frames” and then press [SET].

This displays a file selection screen.

4. Use [▲], [▼], [◀], and [▶] to move the selection boundary to the file you want to delete, and then press [SET].

- This will select the check box in the lower left corner of the selected file’s image and move the blue boundary to the next image.
 - You can enlarge the selected image before deleting it by rotating the zoom controller towards [↻] (Q).
-

5. Repeat step 4 to select other files, if you want. After you are finished selecting files, press [MENU].
-

6. Use [▲] and [▼] to select “Yes” and then press [SET].

- This deletes the files you selected.
 - To cancel the delete operation, select “No” in step 6 and then press [SET].
-

■ Deleting All Files in a CS Group

1. While CS image playback is in progress or paused (toggle by pressing [SET]), press [▼].

This will display the “CS Frame Edit” menu.

2. Use [▲] and [▼] to select “Delete” and then press [SET].
-

3. Use [▲] and [▼] to select “Del Group Images” and then press [SET].
-

4. Use [▲] and [▼] to select “Yes”, and then press [SET].
-

Dividing Up a CS Group

Use the following to divide up a CS Group into individual images.

■ Dividing Up a Specific CS Group

1. In the **PLAY** mode, press **[MENU]**.
2. Press **[◀]**, use **[▲]** and **[▼]** to select the “**▶ PLAY MENU**” tab, and then press **[SET]**.
3. Use **[▲]** and **[▼]** to select “**Divide Group**” and then press **[▶]**.
4. Use **[▲]** and **[▼]** to select “**Select File**”, and then press **[SET]**.
5. Use **[◀]** and **[▶]** to display the CS group you want to divide up.
6. Use **[▲]** and **[▼]** to select “**Divide**” and then press **[SET]**.
 - To divide up other CS group files, repeat steps 5 and 6.

■ Dividing Up All CS Groups

IMPORTANT!

- Once a CS group is divided, it cannot be regrouped.

1. In the **PLAY** mode, press **[MENU]**.
2. Press **[◀]**, use **[▲]** and **[▼]** to select the “**▶ PLAY MENU**” tab, and then press **[SET]**.
3. Use **[▲]** and **[▼]** to select “**Divide Group**” and then press **[▶]**.
4. Use **[▲]** and **[▼]** to select “**All Files**” and then press **[SET]**.
5. Use **[▲]** and **[▼]** to select “**Yes**”, and then press **[SET]**.

Copying a CS Group Image

Use the following procedure to copy an image in a CS group to a location outside of the group.

- 1. While CS image playback is in progress or paused (toggle by pressing [SET]), press [▼].**

This will display the “CS Frame Edit” menu.

- 2. Use [▲] and [▼] to select “Copy”, and then press [SET].**

- 3. Use [◀] and [▶] to display the image you want to copy.**

- 4. Use [▲] and [▼] to select “Copy”, and then press [SET].**

NOTE

- The functions below cannot be performed on snapshots inside a CS group. Before using either of these functions, perform the above procedure to copy the image first.

White Balance, Brightness, Trimming, Rotation, Resize

Zooming an On-screen Image

1. In the PLAY mode, use [◀] and [▶] to scroll through the images until the one you want is displayed.

2. Rotate the zoom controller towards [🔍] (🔍) to zoom.

You can use [▲], [▼], [◀], and [▶] to scroll the zoomed image on the monitor screen. Rotate the zoom controller towards [🔍] to unzoom the image.

- When monitor screen contents are turned on, a graphic in the lower right corner of the screen shows what part of the zoomed image is currently displayed.
 - To exit the zoom screen, press [MENU].
 - Though the maximum image zoom factor is 8X, certain image sizes may not allow zooming up to the full 8X.
- Pressing [SET] will lock the current zoom factor for the on-screen image. You can then use [◀] and [▶] to scroll between images, using the same zoom factor. Pressing [SET] again will unlock the zoom factor and allow you to use [▲], [▼], [◀] and [▶] to move around the currently displayed images. This function cannot be used while viewing CS group images or movies. Also, CS group images and movies will not appear when you are scrolling images with [◀] and [▶].

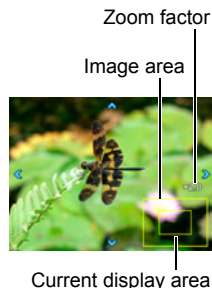

Displaying the Image Menu

1. In the PLAY mode, rotate the zoom controller towards [🔍] (🔍).

Use [▲], [▼], [◀] and [▶] to move the selection boundary around the image menu.

To view a particular image, use [▲], [▼], [◀], or [▶] to move the selection boundary to the image you want and then press [SET].

- In the case of a movie or a continuous shutter (CS) file, the first frame of the file will be displayed.
- A question mark (?) will be displayed for images that cannot be displayed for some reason.



Viewing Snapshots and Movies on a TV Screen

1. Use the optionally available AV cable (EMC-8A) to connect the camera to the TV.

- For details about connecting to the camera and precautions when connecting, see page 17.

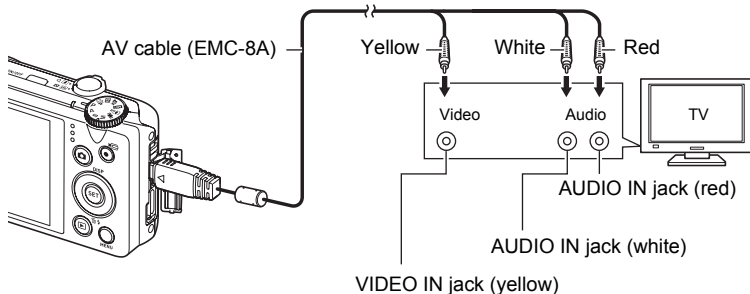

- Make sure that the camera is turned off before plugging in or unplugging the cable. Check the user documentation that comes with the TV for information about requirements before plugging into or unplugging from the TV.

2. Turn on the TV and select its video input mode.

If the TV has more than one video input, select the one where the camera is connected.

3. Turn on the camera and press **[▶]** (PLAY).

This will cause an image to appear on the TV screen, without anything appearing on the camera's monitor screen.

- You also can change the aspect ratio of the screen and the video output system (page 164).

4. Now you can display images and play back movies as you normally do.

IMPORTANT!

- Audio is initially output by the camera at maximum volume. When you first start displaying images, set the TV volume control at a relatively low level and then adjust it as required.

NOTE

- Audio is stereo.
- Some TVs may not be able to output images and/or audio correctly.
- All icons and indicators that appear on the monitor screen also appear on the TV screen. You can use [▲] (DISP) to change the display contents.
- Normally connecting the camera to a TV during recording will cause the camera's monitor screen to go blank and display the image picked up by the camera on the TV screen. If you are using Wide Shot (page 79), the image will be shown on the monitor screen but not the TV screen. Image recording can be performed in either case.

Viewing High-quality Movies on a Hi-Vision Television

Use a commercially available HDMI cable to connect the camera to the TV. For information about playback, see the procedure starting from step 2 under "Viewing Snapshots and Movies on a TV Screen" on page 117.



- Use a commercially available HDMI cable that is marked with the logo shown to the right.

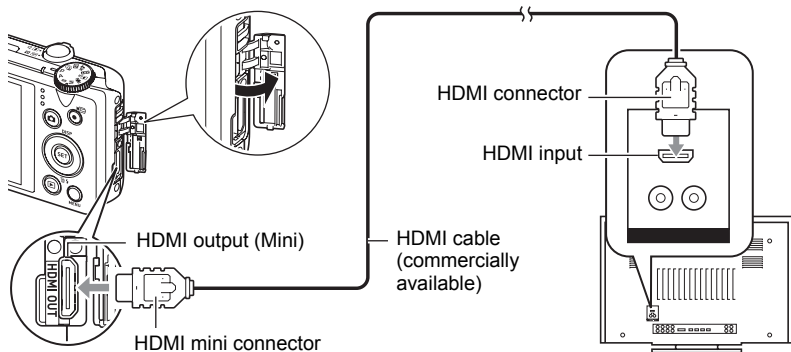

IMPORTANT!

- Output to a TV is not supported while the camera is in the REC mode.

NOTE

- Use a HDMI cable that with a plug that is compatible with the camera's HDMI mini connector on one end, and a plug that is compatible with your TV's HDMI connector on the other end.
- Proper image and/or audio output and other operations may not be possible with some devices.
- Connecting the camera to the HDMI connector of another device can damage both the camera and the other device. Never connect two HDMI output connectors to each other.
- Make sure that the camera is turned off before plugging in or unplugging the cable. Check the user documentation that comes with the TV for information about requirements before plugging into or unplugging from the TV.
- When cables are connected to both the USB/AV port and the HDMI output connector, the HDMI output connector connection is given priority.
- Disconnect the HDMI cable when you are not using HDMI output. The camera's monitor screen may not operate normally while the HDMI cable is connected.
- Audio is stereo.
- Audio is initially output by the camera at maximum volume. When you first start displaying images, set the TV volume control at a relatively low level and then adjust it as required.

■ Selecting the HDMI Terminal Output Method (HDMI Output)

Procedure

[MENU] → “ SETTING” Tab → HDMI Output

Use this setting to select the digital signal format when connecting to a TV with an HDMI cable.

Auto	This setting will cause the format to change automatically in accordance with the connected TV. Normally, you should use this mode.
1080i	1080i format output*
480p	480p format output
576p	576p format output

* 1080i corresponds to 1080 60i, but not 1080 50i. Because of this, the required output method may be 576p when outputting to a digital TV in a PAL reception area that does not support 1080i 60i. If you are in a PAL reception area and nothing is displayed automatically, change the setting to 576p.

- If an image does not appear when “Auto” is selected as the output method, try changing this setting to something else.



IMPORTANT!

- The “HDMI Output” setting cannot be changed as long as there is an HDMI cable connection between the camera and a TV. Disconnect the HDMI cable from the camera to change the “HDMI Output” setting.

Recording Camera Images to a DVD Recorder or Video Deck

Use the following method to connect the camera to the recording device using the AV cable (option).

- DVD recorder or video deck: Connect the AV cable to the VIDEO IN and AUDIO IN terminals.
- Camera: Connect the AV cable to the USB/AV port.

You can play a slideshow of snapshots and movies on the camera and record it on a DVD or video tape. You can record movies by selecting “ Only” for the slideshow “Images” setting (page 121).

For information about connecting a monitor to the recording device and about how to record, see the user documentation that comes with the recording device you are using.

Other Playback Functions (PLAY MENU)



This section explains menu items that you can use to configure settings and perform other playback operations.

For information about menu operations, see page 92.

Playing a Slideshow on the Camera (Slideshow)

Procedure

[▶] (PLAY) → [MENU] → “▶ PLAY MENU” Tab → Slideshow

Start
Starts the slideshow
Images
Specifies the type of images to be included in the slideshow All images: Snapshots, movies, continuous shutter images All except  : All non-continuous shutter (CS) images  Only: Snapshots only  Only: Movies only
Time
Time from the start to the end of the slideshow 3 minutes, 5 minutes, 10 minutes, 15 minutes, 30 minutes, 60 minutes
Interval
Amount of time each image remains displayed Use [▲] and [▼] to select one of the following settings: 1, 3, 5, 10, 15, 20, or 30 seconds, or “MAX”. If you specify a value other than “MAX”, movies play from beginning to end. When the slideshow reaches a movie file while “MAX” is selected, only the first frame of the movie will be displayed.

Effect

Select the effect you want.

Pattern 1 to 5: Plays background music and applies an image change effect.

- Patterns 2 through 4 have different background music, but they all use the same image change effect.
- Pattern 5 can be used for playback of snapshots only (except for those that are part of a CS group), and the “Interval” setting is ignored.
- The currently selected image change effect setting is disabled automatically in following cases.
 - When playing a slideshow for which “ Only” is selected for the “Images” setting
 - When the interval setting is “MAX” or 1 second
 - Before and after playback of a movie
 - During CS group playback (Except the Pattern 1 effect)

Off: No image change effect or background music

- To stop the slideshow, press [SET] or [MENU]. Pressing [MENU] stops the slideshow and returns to the menu screen.
- Adjust audio volume by pressing [▼] and then press [▲] or [▼] during playback.
- All button operations are disabled while the slideshow is transitioning from one image to another.
- The time required for transition from one image to another may be longer in the case of an image that was not recorded with this camera.

Transferring Music from Your Computer to Camera Memory

You can replace the built-in slideshow background music with other music from your computer.

Supported File Types:

- PCM format (16-bit, monaural / stereo) WAV files
- Sampling Frequencies: 11.025 kHz/22.05 kHz/44.1 kHz

Number of Files: 9

File names: SSBGM001.WAV to SSBGM009.WAV

- Create the music files on your computer using the above names.
- Regardless of which effect pattern you select, the music files you store in camera memory are played back in name sequence.

1. Connect the camera to your computer (pages 142, 146).

If you plan to save the music files to the camera’s memory card, make sure the card is loaded in the camera.

2. Perform one of the following operations to open the memory card or built-in memory.

This will cause the camera to be recognized by your computer as a Removable Disk (Drive).

- Windows
 - ① Windows 8: Desktop → Explorer
Windows 7, Windows Vista: Start → Computer
Windows XP: Start → My Computer
 - ② Double-click "Removable Disk".
- Macintosh
 - ① Double-click the camera's drive icon.

3. Create a folder named "SSBGM".

4. Double-click the "SSBGM" folder you created and copy the background music file to it.

- See the user documentation that comes with your computer for information about moving, copying, and deleting files.
- If there are background music files both in built-in memory and on the memory card loaded in the camera, the files on the memory card take priority.
- See page 153 for information about camera folders.

5. Disconnect the camera from the computer (pages 143, 146).

Creating a Snapshot of Movie Frames (MOTION PRINT)

Procedure

[▶] (PLAY) → Movie Screen → [MENU] → "▶ PLAY MENU" Tab → MOTION PRINT

1. Use [◀] and [▶] to scroll through the movie frames and display the one you want to use as the image of the MOTION PRINT image.

Holding down [◀] or [▶] scrolls at high speed.

2. Use [▲] and [▼] to select "Create" and then press [SET].

- Only the frames of movies recorded on this camera can be used in a MOTION PRINT image.

Editing a Movie on the Camera (Movie Editing)

Procedure

[▶] (PLAY) → **Movie Screen of Movie to be Edited** → [MENU] →
“▶ PLAY MENU” Tab → **Movie Editing**

The Movie Editing feature lets you use one of the following procedures to edit out a specific part of a movie.

Previous Cut	Cuts everything from the beginning of the movie up to the current location.
Intermediate Cut	Cuts everything between two points.
Next Cut	Cuts everything from the current location to the end of the movie.

1. Use [▲] and [▼] to select the editing method you want to use and then press [SET].
2. Use the following operations to select the frame (point) from which or to which you want to cut the movie (the cut point).

[◀] [▶]	During playback, changes the playback direction and playback speed. While playback is paused, scrolls forward or back.
[SET]	Toggles between pause and play.

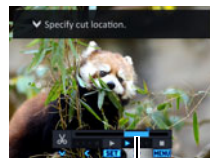

Cut range (blue)

3. Press [▼] to display the editing menu and specify one or two cut points.

Previous Cut	While the frame you want the cut to be up to is displayed, press [▼].
Intermediate Cut	① While the frame you want the first (From) cut to be is displayed, press [▼]. ② Select another frame. ③ While the frame you want the second (To) cut to be is displayed, press [▼].
Next Cut	While the frame you want the cut to be from is displayed, press [▼].

4. Use [▲] and [▼] to select “Yes” and then press [SET].

The selected cut operation will take considerable time to complete. Don't try to perform any camera operation until the “Busy... Please wait...” message disappears from the monitor screen. Note that a cut operation can take a long time if the movie being edited is long.



IMPORTANT!

- When you edit a movie, only the result is saved. The original movie is not retained. An editing operation cannot be undone.

NOTE

- A movie that is shorter than five seconds cannot be edited.
- Editing of movies recorded with a different type of camera is not supported.
- You will not be able to edit a movie if the amount of remaining memory capacity is less than the size of the movie file you want to edit. If there is not enough memory available, delete files you no longer need to free up more.
- Splitting of a movie into two movies and splicing of two different movies into a single movie are not supported.
- You also can start a movie editing operation while the movie you want to edit is playing back. When playback reaches a frame where you want a cut point to be, press [SET] to pause playback. Next, press [▼] to display the menu of editing options. Perform editing using the same procedures as described above.

Optimizing Image Brightness (Lighting)

Procedure

[▶] (PLAY) → Snapshot Screen → [MENU] →
“▶ PLAY MENU” Tab → Lighting



You can use this setting to adjust the balance between bright areas and dark areas in existing images in the range of 0 (no optimization) to +2 (bright).

NOTE







- Correcting the lighting when shooting produces better results (page 101).
- Altering the lighting of an image causes the original image and the new (altered) version to be stored as separate files.
- When you display an altered image on the camera's monitor screen, the date and time indicates when the image was originally recorded, not when the image was altered.

Adjusting White Balance (White Balance)

Procedure

[] (PLAY) → Snapshot Screen → [MENU] →
“ PLAY MENU” Tab → White Balance

You can use the white balance setting to select a light source type for a recorded image, which will affect the colors of the image.



 Daylight	Outdoors, fair weather
 Overcast	Outdoors, cloudy to rain, in tree shade, etc.
 Shade	Very high temperature light, such as building shade, etc.
 Day White Fluor	White or day white fluorescent lighting, without suppressing color cast
 Daylight Fluor	Daylight fluorescent lighting, while suppressing color cast
 Tungsten	Suppressing of the appearance of light bulb lighting
Cancel	No white balance adjustment

NOTE

- You also can adjust the white balance when recording images (page 40).
- The original snapshot is retained in memory and not deleted.
- When you display an altered image on the camera's monitor screen, the date and time indicates when the image was originally recorded, not when the image was altered.

Adjusting the Brightness of an Existing Snapshot (Brightness)

Procedure

[] (PLAY) → Snapshot Screen → [MENU] →
“ PLAY MENU” Tab → Brightness

You can select one of five brightness levels, from +2 (brightest) to -2 (least bright).

NOTE

- The original snapshot is retained in memory and not deleted.
- When you display an altered image on the camera's monitor screen, the date and time indicates when the image was originally recorded, not when the image was altered.

Selecting Images for Printing (DPOF Printing)

Procedure

[▶] (PLAY) → Snapshot Screen → [MENU] →
“▶ PLAY MENU” Tab → DPOF Printing

See page 135 for details.

Protecting a File Against Deletion (Protect)

Procedure

[▶] (PLAY) → [MENU] → “▶ PLAY MENU” Tab → Protect

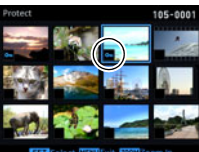
Select File	<p>Protects specific files.</p> <p>① Use [◀] and [▶] to select the image that you want to protect.</p> <ul style="list-style-type: none">To view a particular image, rotate the zoom controller. <p>② Press [SET].</p> <p>An image that is protected is indicated by the  icon.</p> <p>③ To protect other files, repeat steps 1 and 2.</p> <p>To exit the protect operation, press [MENU]. To unprotect a file, select an protected image and then press [SET].</p>	
All Files	<p>Protects all files.</p> <p>① Use [▲] and [▼] to select “All Files: On” and then press [SET].</p> <p>② Press [MENU].</p> <p>To unprotect all files, select “All Files: Off” instead of “All Files: On” in step 1 above.</p>	



IMPORTANT!

- Note that even if a file is protected, it will be deleted if you perform the format operation (page 165).

■ To protect a specific image in a CS group

1. While CS image playback is in progress or paused (toggle by pressing [SET]), press [▼].

This will display the “CS Frame Edit” menu.

2. Use [▲] and [▼] to select “Protect” and then press [SET].
-

3. Use [▲] and [▼] to select “Select Frames”, and then press [SET].
-

4. Use [◀] and [▶] to select the image that you want to protect, and then press [SET].

This will protect the image and display the  icon.

- To view a particular image, rotate the zoom controller.
 - To unprotect a file, select an protected image and then press [SET].
-

5. After you are finished, press [MENU] to exit this operation.

IMPORTANT!

- Note that even if a file is protected, it will be deleted if you perform the format operation (page 165).

■ To protect all the images in a CS group

1. While CS image playback is in progress or paused (toggle by pressing [SET]), press [▼].
-

2. Use [▲] and [▼] to select “Protect” and then press [SET].
-

3. Use [▲] and [▼] to select “Frame all”, and then press [SET].
-

4. Use [▲] and [▼] to select “All Frames On” and then press [SET].

This will protect all the images in the group and display the  icon.

- To unprotect all of the images in the group, select “All Frames Off” in step 4 and then press [SET].

IMPORTANT!

- Note that even if a file is protected, it will be deleted if you perform the format operation (page 165).

Editing the Date and Time of an Image (Date/Time)

Procedure

[] (PLAY) → Snapshot Screen → [MENU] →
“ PLAY MENU” Tab → Date/Time

[▲] [▼]	Changes the setting at the cursor location.
[◀] [▶]	Moves the cursor between settings.

When the date and time settings are what you want, align the cursor with “Apply” and then press [SET] to apply them.

- To switch between 12-hour and 24-hour timekeeping, move the cursor to the current setting (“am (pm)” or “24h”) and then use [▲] or [▼] to change the setting.

NOTE

- The date and time stamped into an image using the Time Stamp (page 157) cannot be edited.
- You cannot edit the date and time of an image that is protected.
- You can input any date from 1980 to 2049.

Rotating an Image (Rotation)

Procedure

[] (PLAY) → Snapshot or Movie Screen → [MENU] →
“ PLAY MENU” Tab → Rotation

1. Use [▲] and [▼] to select “Rotation” and then press [SET].
Each press of [SET] will rotate the displayed image 90 degrees left.
2. When the displayed image is at the orientation you want, press [MENU].

NOTE

- Rotating a CS image causes all of the images in the CS group to be rotated. You cannot rotate individual component image in a CS group.
- Rotation of a panorama image is not supported.
- Note that this procedure does not actually change the image data. It simply alters how the image is displayed on the camera’s monitor screen.
- An image that has been protected or zoomed cannot be rotated.
- The original (unrotated) version of the image will be displayed on the image menu screen.

Resizing a Snapshot (Resize)

Procedure

[▶] (PLAY) → Snapshot Screen → [MENU] →
“▶ PLAY MENU” Tab → Resize

You can reduce the size of a snapshot and save the result as a separate snapshot. The original snapshot is also retained. You can resize an image to one of three sizes: 10M, 3M, VGA.

- Resizing a 3:2 or 16:9 size snapshot will create an image with an aspect ratio of 4:3, with both sides cut off.
- The recording date of the resized version of the snapshot will be the same as the recording date of the original snapshot.

Cropping a Snapshot (Trimming)

Procedure

[▶] (PLAY) → Snapshot Screen → [MENU] →
“▶ PLAY MENU” Tab → Trimming

You can crop a snapshot to trim parts you do not need, and save the result in a separate file. The original snapshot is also retained.

Use the zoom controller to zoom the image to the size you want, use [▲], [▼], [◀], and [▶] to display the portion of the image you want to cut out, and then press [SET].

- The image produced by cropping a 3:2 or 16:9 image will have an aspect ratio of 4:3.
- The recording date of the cropped image will be the same as the recording date of the original snapshot.

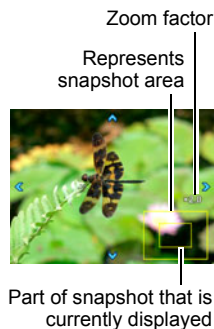





Copying Files (Copy)

Procedure

[] (PLAY) → Snapshot or Movie Screen → [MENU] →
“ PLAY MENU” Tab → Copy

Files can be copied from the camera's built-in memory to a memory card or from a memory card to built-in memory.

Built-in → Card	Copies all files from built-in camera memory to a memory card. This option copies all the files in built-in camera memory. It cannot be used to copy a single file.
Card → Built-in	Copies a single file on the memory card to camera built-in camera memory. Files are copied to the folder in built-in memory whose name has the largest serial number. <ul style="list-style-type: none">• You cannot copy a continuous shutter (CS) group image (page 115). <ol style="list-style-type: none">① Use [] and [] to select the file you want to copy.② Use [] and [] to select “Copy” and then press [SET].

NOTE

- You can copy snapshots or movies you recorded with this camera.

Dividing Up a Continuous Shutter Group (Divide Group)



Procedure

[] (PLAY) → [MENU] → “ PLAY MENU” Tab → Divide Group

See page 114 for details.

Combining CS Images into a Single Still Image (CS Multi Print)

Procedure

[] (PLAY) → Display CS group. → [MENU] →
“ PLAY MENU” Tab → CS Multi Print

1. Use [] and [] to select “Create”.

- You can use [] and [] to select a different CS group, if you want.

2. Press [SET].

This converts the CS group to a 16M (4608×3456) image with up to 30 CS frames (5 vertical × 6 horizontal).

- This camera may not be able to correctly convert a CS group image with another camera.
- The recording date of the converted image will be the same as the recording date of the original CS group.
- When converting a CS group whose images have been rotated by the “Rotation” feature to a CS Multi Print image, the arrangement of the images in the CS Multi Print will be different from that of normal (unrotated) CS images.

Editing a CS Image (CS Frame Edit)

Procedure

[] (PLAY) → [MENU] → “ PLAY MENU” Tab → CS Frame Edit

See the following pages for details.

DPOF Printing: page 135

Protect: page 127

Copy: page 115

Delete: page 112

Printing

Printing Snapshots

Professional Print Service*

You can take a memory card that contains the images you want to print to a professional print service and have them printed.



Printing on a Home Printer*

Printing Images on a Printer with Memory Card Slot

You can use a printer equipped with a memory card slot to print images directly from a memory card. For details, see the user documentation that comes with your printer.



Connecting Directly to a PictBridge Compatible Printer

You can print on a printer that supports PictBridge (page 133).

Printing with a Computer

After transferring the images to your computer, use commercially available software to print.

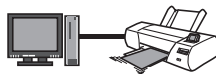

* You can specify which images you want to print, the number of copies, and date stamp settings before printing (page 135).

Connecting Directly to a PictBridge Compatible Printer

You can connect the camera directly to a printer that supports PictBridge and print images without going through a computer.

■ To set up the camera before connecting to a printer

1. Turn on the camera and press [MENU].
2. On the “⚙️ SETTING” tab, select “USB” and then press [▶].
3. Use [▲] and [▼] to select “PictBridge”, and then press [SET].

■ Connecting the Camera to a Printer

Use the USB cable that comes bundled with the camera to connect the camera to your printer's USB port.

- For details about connecting to the camera and precautions when connecting, see page 17.

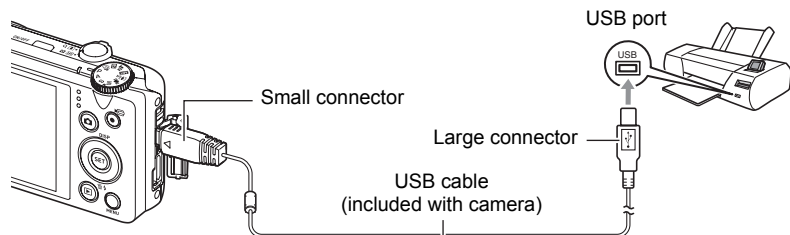

- The camera does not draw power over the USB cable. Check the battery level before connecting and make sure it is not too low.
- Make sure that the camera is turned off before plugging in or unplugging the cable. Check the user documentation that comes with the printer for information about requirements before plugging into or unplugging from the printer.

■ To print

1. Turn on the printer and load paper.

2. Turn on the camera.

This will display the print menu screen.

3. Use [▲] and [▼] to select “Paper Size”, and then press [▶].

4. Use [▲] and [▼] to select a paper size and then press [SET].

- The following are the available paper sizes.
3.5"×5", 5"×7", 4"×6", A4, 8.5"×11", By Printer
- Selecting “By Printer” prints using a paper size selected on the printer.
- See the documentation that comes with your printer for information about paper settings.

5. Use [▲] and [▼] to specify the print option you want.

1 Image : Prints one image. Select and then press [SET]. Next, use [◀] and [▶] to select the image you want to print.

DPOF Printing: Prints multiple images. Select and then press [SET]. With this option, images will be printed in accordance with DPOF settings (page 135).

- To toggle date stamping on and off, press [●] (Movie). The date stamp will be printed when “On” is indicated on the monitor screen.

6. Use [▲] and [▼] to select “Print” and then press [SET].

Printing will start and the message “Busy... Please wait...” will appear on the monitor screen. The message will disappear after a short while, even though printing is still being performed. Pressing any camera button will cause the printing status to re-appear. The print menu screen will re-appear when printing is complete.

- If you selected “1 Image”, you can repeat the procedure from step 5, if you want.

7. After printing is complete, turn off the camera and disconnect the USB cable from the printer and camera.

Using DPOF to Specify Images to be Printed and the Number of Copies (DPOF Printing)

■ Digital Print Order Format (DPOF)

DPOF is a standard that allows you to include image type, number of copy, and time stamp on/off information on the memory card with the images.

After configuring settings, you can use the memory card to print on a home printer that supports DPOF or take the memory card to a professional print service.



- Whether or not you will be able to use DPOF settings for printing depends on the printer you are using.
- Some professional print services may not support DPOF.

■ Configuring DPOF Settings Individually for Each Image

▶ Procedure

[▶] (PLAY) → Snapshot Screen → [MENU] →
“▶ PLAY MENU” Tab → DPOF Printing → Select images

1. Use [◀] and [▶] to scroll through the files until the image you want to print is displayed.

2. Use [▲] and [▼] to specify the number of copies.

You can specify a value up to 99. Specify 00 if you do not want to print the image.

- If you want to include the date in the images, press [●] (Movie) so “On” is shown for date stamping.
 - Repeat steps 1 and 2 to configure settings for other images, if you want.
-

3. Press [SET].

■ Configuring the Same DPOF Settings for All the Images

▶ Procedure

[▶] (PLAY) → Snapshot Screen → [MENU] →
“▶ PLAY MENU” Tab → DPOF Printing → All images

1. Use [▲] and [▼] to specify the number of copies.

You can specify a value up to 99. Specify 00 if you do not want to print the image.

- Note that the specified number of copies will be printed for all of the images in any CS group included with the images.
 - If you want to include the date in the images, press [●] (Movie) so “On” is shown for date stamping.
-

2. Press [SET].

■ **To specify the number of copies for a specific image in a CS group**

- 1. While CS image playback is in progress or paused (toggle by pressing [SET]), press [▼].**

This will display the “CS Frame Edit” menu.

- 2. Use [▲] and [▼] to select “DPOF Printing” and then press [SET].**
-

- 3. Use [▲] and [▼] to select “Select Frames” and then press [SET].**
-

- 4. Use [◀] and [▶] to scroll through images until one you want to print is displayed.**
-

- 5. Use [▲] and [▼] to specify the number of copies.**

You can specify a value up to 99. Specify 00 if you do not want to print the image.

- If you want to include the date in the images, press [●] (Movie) so “On” is shown for date stamping.
 - Repeat steps 4 and 5 to configure settings for other images, if you want.
-

- 6. Press [SET].**

■ **To configure the same DPOF settings for all the images in a CS group**

- 1. While CS image playback is in progress or paused (toggle by pressing [SET]), press [▼].**

This will display the “CS Frame Edit” menu.

- 2. Use [▲] and [▼] to select “DPOF Printing” and then press [SET].**
-

- 3. Use [▲] and [▼] to select “Frame all” and then press [SET].**
-

- 4. Use [▲] and [▼] to specify the number of copies.**

You can specify a value up to 99. Specify 00 if you do not want to print the image.

- If you want to include the date in the images, press [●] (Movie) so “On” is shown for date stamping.
-

- 5. Press [SET].**

DPOF settings are not cleared automatically after printing is complete.

The next DPOF print operation you execute will be performed using the last DPOF settings you configured for the images. To clear DPOF settings, specify "00" for the number of copies of all images.

Tell your print service about your DPOF settings!

If you take a memory card to a professional print service, be sure to tell them that it includes DPOF settings for the images to be printed and the number of copies. If you don't, the print service may print all the images without regard to your DPOF settings, or they may ignore your date stamp setting.

■ Date Stamping

You can use one of the following three methods to include the recording date in the printout of an image.

Configuring camera settings
Configure DPOF settings (page 135). You can turn date stamping on and off each time you print. You can configure settings so some images include the date stamp and some don't.
Configure the Camera's Timestamp setting (page 157). <ul style="list-style-type: none">• The camera's Timestamp setting imprints the date into a snapshot when you shoot it, so the date is always included when you print. It cannot be deleted.• Do not turn on DPOF date stamping for an image that includes a date stamped with the camera's Timestamp function. Doing so can cause the two stamps to be overprinted.
Configuring computer settings
You can use commercially available image management software to date stamp images.
Professional print service
Request date stamping when ordering prints from a professional print service.

■ Standards Supported by the Camera

- PictBridge

This is a standard of the Camera and Imaging Products Association (CIPA). You can connect the camera directly to a printer that supports PictBridge, and perform image selection and printing using the camera monitor screen and controls.



- PRINT Image Matching III

Using image editing software and printing on a printer that supports PRINT Image Matching III makes it possible to use information about shooting conditions that is recorded with the image, and produce exactly the type of image you want. PRINT Image Matching and PRINT Image Matching III are trademarks of Seiko Epson Corporation.



- Exif Print



Printing on a printer that supports Exif Print uses information about shooting conditions recorded with the image to enhance printed image quality. Contact your printer manufacturer for information about models that support Exif Print, printer upgrades, etc.



Using the Camera with a Computer

Things you can do using a computer...

You can perform the operations described below while the camera is connected to a computer.

<p>Save images to a computer and view them there</p> 	<ul style="list-style-type: none">• Save images and view them manually (USB connection) (pages 141, 145).• Transfer images to a computer automatically over a wireless LAN for viewing (Eye-Fi) (page 148).
<p>Play back and edit movies</p> 	<ul style="list-style-type: none">• You can play back movies (pages 144, 147). To play back movies, use software that is compatible with your computer's operating environment.• To edit movies, use commercially available software as required.

The procedures you need to perform are different for Windows and the Macintosh.

- Windows users should refer to "Using the Camera with a Windows Computer" on page 141.
- Macintosh users should refer to "Using the Camera with a Macintosh" on page 145.

Using the Camera with a Windows Computer

When you want to do this:	Operating System Version	Install this software:	See page:
Save images to a computer and view them there manually	Windows 8, Windows 7, Windows Vista, Windows XP (SP3)	Installation not required.	141
Play movies	Windows 8, Windows 7	Installation not required. <ul style="list-style-type: none">Windows Media Player 12, which is already installed on most computers, can be used for playback.	144
	Windows Vista, Windows XP (SP3)	Movies can be played back using QuickTime 7. <ul style="list-style-type: none">You need to download QuickTime 7 on the Web if you want to use it.	

Viewing and Storing Images on a Computer

You can connect the camera to your computer in order to view and store images (snapshot and movie files).

Never use your computer to modify, delete, move, or rename any image files that are in the camera's built-in memory or on its memory card.

Doing so can cause problems with the camera's image management data, which will make it impossible to play back images on the camera and can drastically alter remaining memory capacity. Whenever you want to modify, delete, move, or rename an image, do so only on images that are stored on your computer.

IMPORTANT!

- Never unplug the USB cable, or operate the camera while viewing or storing images. Doing so can cause data to become corrupted.

NOTE

- You also can use your computer's card slot (if it has one) or a commercially available card reader to access image files directly from the camera's memory card. For details, see the user documentation that comes with your computer.

■ To connect the camera to your computer and save files

1. Turn on the camera and press [MENU].
2. On the “**⚙️ SETTING**” tab, select “**USB**” and then press [▶].
3. Use [▲] and [▼] to select “**Mass Storage**”, and then press [SET].

4. Turn off the camera and then use the USB cable that comes with the camera to connect it to your computer.

- For details about connecting to the camera and precautions when connecting, see page 18.

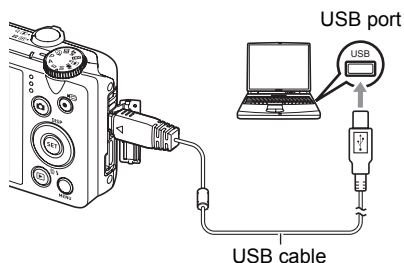

5. Turn on the camera.

- The first time you connect the camera to your computer with the USB cable, an error message may appear on your computer. If this happens, disconnect and then reconnect the USB cable.

6. **Windows 8 users: Click “Desktop” and then “Explorer”.**
Windows 7, Windows Vista users: Click “Start” and then “Computer”.
Windows XP users: Click “Start” and then “My Computer”.

7. Double-click “Removable Disk”.

- Your computer recognizes the memory card loaded in the camera (or built-in memory if there is no card) as a removable disk.

8. Right-click the “DCIM” folder.

9. On the shortcut menu that appears, click “Copy”.

10. **Windows 8 users: Click “Documents”.**

Windows 7, Windows Vista users: Click “Start” and then “Documents”.
Windows XP users: Click “Start” and then “My Documents”.

- If you already have a “DCIM” folder in “Documents” (Windows 8, Windows 7, Windows Vista) or “My Documents” (Windows XP), the next step will overwrite it. If you want to keep the existing “DCIM” folder, you need to change its name or move it to a different location before performing the next step.

11. Windows 8 users: On the “Documents” menus, click “Home” and then “Paste”.

Windows 7 users: On the “Documents” “Organize” menu, select “Paste”.

Windows Vista users: On the “Documents” “Edit” menu, select “Paste”.

Windows XP users: On the “My Documents” “Edit” menu, select “Paste”.

This will paste the “DCIM” folder (and all the image files it contains) into your “Documents” (Windows 8, Windows 7, Windows Vista) or “My Documents” (Windows XP) folder. You now have a copy of the files that are in camera memory on your computer.

12. After you finish copying images, disconnect the camera from the computer.

After confirming that the back lamp is not flashing red, disconnect the USB cable.

■ To view images you copied to your computer

1. Double-click the copied “DCIM” folder to open it.

2. Double-click the folder that contains the images you want to view.

3. Double-click the image file you want to view.

- For information about file names, see “Memory Folder Structure” on page 153.
- An image that was rotated on the camera will be displayed on your computer screen in its original (unrotated) orientation.
- Viewing a CS image on a computer will individually display the component images in the CS group. A CS group cannot be viewed as a CS image on a computer.

Playing Movies

To play back a movie, first copy it to your computer and then double-click the movie file. Some operating systems may not be able to play back movies. If this happens, you need to install separately available software.

- With Windows 8 and Windows 7, playback is supported by Windows Media Player 12.
- If you are unable to play back movies, go to the URL below to download QuickTime 7 and install it on your computer.
<http://www.apple.com/quicktime/>

■ Minimum Computer System Requirements for Movie Playback

The minimum system requirements described below are necessary to play back movies recorded with this camera on a computer.

Operating System : Windows 8, Windows 7, Windows Vista, Windows XP (SP3)

CPU : Image Quality "FHD" or "HD":
Core 2 Duo 3.0GHz or higher
Image Quality "STD" or "HS":
Pentium 4 3.2GHz or higher

Required Software: QuickTime 7 (Not required with Windows 8 and Windows 7.)

- The above are recommended system environments. Configuring one of these environments does not guarantee proper operation.
- Certain settings and other installed software may interfere with proper playback of movies.

■ Movie Playback Precautions

- Be sure to move the movie data to the hard disk of your computer before trying to play it. Proper movie playback may not be possible for data accessed over a network, from a memory card, etc.
- Proper movie playback may not be possible on some computers. If you experience problems, try the following.
 - Try recording movies with a quality setting of "STD".
 - Quit any other applications you have running, and stop resident applications.

Even if proper playback is not possible on the computer, you can use the AV cable (option) to connect to the video input terminal of a TV or computer and play back movies that way.

Using the Camera with a Macintosh

When you want to do this:	Operating System Version	Install this software:	See page:
Save images to your Macintosh and view them there manually	OS X	Installation not required.	145
Save images to your Macintosh automatically/ Manage images	OS X	Use iPhoto, which comes bundled with some Macintosh products.	–
Play movies	OS X	Movie file playback is supported under OS X 10.4.11 or higher when QuickTime 7 or higher is installed.	147

Connecting the Camera to Your Computer and Saving Files

Never use your computer to modify, delete, move, or rename any image files that are in the camera's built-in memory or on its memory card.

Doing so can cause problems with the camera's image management data, which will make it impossible to play back images on the camera and can drastically alter remaining memory capacity. Whenever you want to modify, delete, move, or rename an image, do so only on images that are stored on your computer.



IMPORTANT!

- Never unplug the USB cable, or operate the camera while viewing or storing images. Doing so can cause data to become corrupted.
- The camera does not support operation with Mac OS X 10.0. Operation is supported with Mac OS 10.1, 10.2, 10.3, 10.4, 10.5, 10.6, 10.7, and 10.8 (using the OS standard USB driver) only.

NOTE

- You also can use your computer's card slot (if it has one) or a commercially available card reader to access image files directly from the camera's memory card. For details, see the user documentation that comes with your computer.

■ To connect the camera to your computer and save files

1. Turn on the camera and press [MENU].

2. On the “⚙️ SETTING” tab, select “USB” and then press [▶].

3. Use [▲] and [▼] to select “Mass Storage”, and then press [SET].

4. Turn off the camera and then use the USB cable that comes with the camera to connect it to your Macintosh.

- For details about connecting to the camera and precautions when connecting, see page 18.

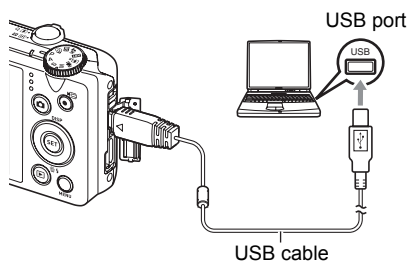

5. Turn on the camera.

The camera's back lamp will light green or amber at this time. In this mode, your Macintosh recognizes the memory card loaded in the camera (or the camera's built-in memory if it does not have a memory card loaded) as a drive. The appearance of the drive icon depends on the Mac OS version you are using.

- The first time you connect the camera to your Macintosh with the USB cable, an error message may appear on your computer. If this happens, disconnect and then reconnect the USB cable.
-

6. Double-click the camera's drive icon.

7. Drag the “DCIM” folder to the folder to which you want to copy it.

8. After the copy operation is complete, drag the drive icon to Trash.

9. Disconnect the camera from the computer.

After confirming that the back lamp is not flashing red, disconnect the USB cable.

■ To view copied images

1. Double-click the camera's drive icon.

2. Double-click the "DCIM" folder to open it.

3. Double-click the folder that contains the images you want to view.

4. Double-click the image file you want to view.

- For information about file names, see "Memory Folder Structure" on page 153.
- An image that was rotated on the camera will be displayed on your Macintosh screen in its original (unrotated) orientation.
- Viewing a CS image on a computer will individually display the component images in the CS group. A CS group cannot be viewed as a CS image on a computer.

■ Playing a Movie

You can use QuickTime, which comes bundled with your operating system, to play back movies on a Macintosh. To play back a movie, first copy it to your Macintosh and then double-click the movie file.

■ Minimum Computer System Requirements for Movie Playback

The minimum system requirements described below are necessary to play back movies recorded with this camera on a computer.

Operating System : Image Quality "FHD" or "HD":
Mac OS X 10.4.11 or higher
Image Quality "STD" or "HS":
Mac OS X 10.3.9 or higher

Required Software: QuickTime 7 or higher

- The above are recommended system environments. Configuring one of these environments does not guarantee proper operation.
- Certain settings and other installed software may interfere with proper playback of movies.

■ Movie Playback Precautions

Proper movie playback may not be possible on some Macintosh models. If you experience problems, try the following.

- Try recording movies with a quality setting of “STD”.
- Upgrade to the latest version of QuickTime.
- Shut down other applications that are running.

Even if proper playback is not possible on your Macintosh, you can use the AV cable (option) to connect to the video input terminal of a TV or Macintosh and play back movies that way.



IMPORTANT!

- Be sure to move the movie data to the hard disk of your Macintosh before trying to play it. Proper movie playback may not be possible for data accessed over a network, from a memory card, etc.

Using an SD Memory Card with Built-in LAN

Transferring Images with an Eye-Fi Card (Eye-Fi)

Shooting with an Eye-Fi wireless SD memory card loaded in the camera makes it possible to transfer image data automatically to a computer via wireless LAN.

1. Configure LAN access point, transfer destination and other settings for the Eye-Fi card in accordance with the instructions that come with the Eye-Fi card.

2. After configuring settings, load the Eye-Fi card into the camera and record.



Images you record are sent by wireless LAN to your computer, etc.

- For full details, see the user documentation that comes with the Eye-Fi card.
- Before formatting a new Eye-Fi card to use it for the first time, copy the Eye-Fi Center install files to your computer. Do this before formatting the card.

IMPORTANT!

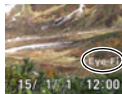
- Recorded images are transferred over wireless LAN. Do not use the Eye-Fi card or turn off Eye-Fi card communication (page 156) when on an aircraft or in any other location where use of wireless communication is limited or prohibited.
- Loading an Eye-Fi card will cause the Eye-Fi indicator  to appear on the monitor screen. Its transparent or not transparent appearance indicates the communication status as shown below.



Transparent		Access point cannot be found or no transferable image data exists.
Not transparent		Image transfer in progress
Flashing		Searching for access points

- A communication icon  will appear on the monitor screen while image data transfer is in progress.
- The camera's Auto Power Off (page 159) function is disabled while image data transfer is in progress.
- A confirmation message will appear on the monitor screen if you try to turn off the camera while image data transfer is in progress. Follow the instructions in the messages (page 189).
- Transfer of a large number of images can take some time to complete.
- Depending on the type of Eye-Fi card you are using and its settings, images on the Eye-Fi card may be deleted following image data transfer.
- Breaks in the image and/or audio may occur when recording a movie to or playing a movie from an Eye-Fi card.
- Proper Eye-Fi card data communication may not be possible due to camera settings, battery level, or operating conditions.

Using a Smartphone to Play Back Images Stored on a FlashAir Card (FlashAir)

Loading a commercially available FlashAir card in the camera makes it possible to view images on and copy them to a smartphone or computer over a wireless LAN connection.

- For more information, see the instructions that come with the card.

1. Use a computer or other device to configure the settings of the FlashAir card.

- To protect your personal information, it is recommended that you change the password of a FlashAir card after you purchase it. For more information, see the instructions that come with the card.
- If the FlashAir card's "Start automatically at boot" setting is selected, a wireless LAN connection will be established automatically whenever the camera is turned on.
- If you want to turn "FlashAir" (page 156) on and off manually on the camera, change the FlashAir card's setting to "Start with the control image".



2. Load the configured FlashAir card into the camera and shoot the images you want.

- Formatting a FlashAir card with the camera will delete files on the card that are required for communication. For details about formatting, see the instructions that come with the card.

3. Access the FlashAir card from a smartphone or other device.

IMPORTANT!

- When on an aircraft or in any other location where use of wireless communication is limited or prohibited, do not use a FlashAir card, or change the camera's "FlashAir" setting (page 156) and the FlashAir card's setting to those shown below.
FlashAir: Off
Memory Card: Start with the control image
- Loading a FlashAir card into the camera will cause the FlashAir icon  to appear on the monitor screen.

Transparent		No wireless LAN connection
Not transparent		Communication enabled
Flashing		Running (Communication disabled)

- The following applies to camera operations while image data on a FlashAir card is being manipulated from a smartphone or other device.
 -  icon displayed on the monitor screen.
 - The Sleep function (page 159) and Auto Power Off function (page 159) are disabled.
 - A confirmation message appears on the monitor screen if you try to turn it off. If this happens, follow the instructions in the message (page 189).
- The FlashAir wireless LAN connection is automatically terminated if no operation is performed for a certain amount of time.
- Recording or playing back a movie to a FlashAir card can result in breaks in the image and/or audio.
- Proper FlashAir card communication may not be possible due to camera settings, battery level, or operating conditions.
- Changing the configuration of camera settings and performing other operations may take longer than normal when a FlashAir card is running.

Files and Folders

The camera creates a file each time you shoot a snapshot, record a movie, or perform any other operation that stores data. Files are grouped by storing them in folders. Each file and folder has its own unique name.

- For details about how folders are organized in memory, see “Memory Folder Structure” (page 153).

Name and Maximum Number Allowed	Example
File	
Each folder can contain up to 9999 files named CIMG0001 through CIMG9999. The extension on the file name depends on the file type.	26th file name: CIMG0026.JPG Serial number Extension (4 digits)
Folders	
Folders are named from 100CASIO to 999CASIO. There can be up to 900 folders in memory. <ul style="list-style-type: none">• BEST SHOT has a scene named “For YouTube” that optimizes movie settings for recording movies for upload to YouTube. Images recorded with the YouTube scene are stored in a folder named “100YOUTB”.	100th folder name: 100CASIO Serial number (3 digits)

- You can view folder and file names on your computer. For details about how file names are displayed on the camera’s monitor screen, see pages 11 and 12.
- The total number of folders and files allowed depends on the image size and quality, and capacity of the memory card being used for storage.

Memory Card Data

The camera stores images you shoot in accordance with the Design Rule for Camera File System (DCF).

■ About DCF

The following operations are supported for DCF-compliant images. Note, however, that CASIO makes no performance guarantees concerning these operations.

- Transferring this camera's DCF-compliant images to another manufacturer's camera and view them.
- Printing this camera's DCF-compliant images on another manufacturer's printer.
- Transferring another camera's DCF-compliant images to this camera and view them.

■ Memory Folder Structure

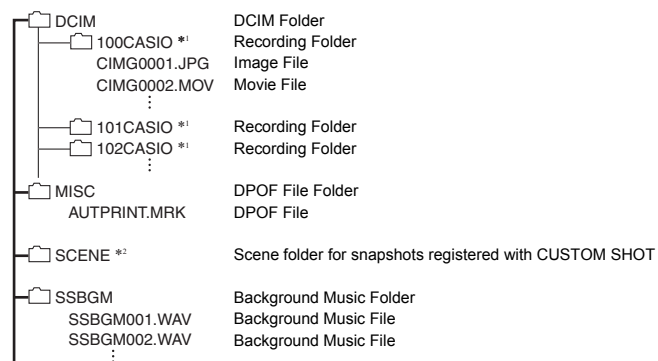

*1 The BEST SHOT "For YouTube" scene sets up the camera for recording movies that are optimized for uploading to YouTube. Images recorded with the "For YouTube" scene are stored in a folder named "100YOUTB".

*2 This folder or file can be created in built-in memory only.

■ Supported Image Files

- Image files shot with this camera
- DCF-compliant image files

This camera may not be able to display an image, even if it is DCF-compliant. When displaying an image recorded on another camera, it may take a long time for the image to appear on this camera's monitor screen.

■ Built-in Memory and Memory Card Data Handling Precautions

- Whenever copying memory contents to your computer, you should copy the DCIM folder and all of its contents. A good way to keep track of multiple DCIM folders is to change their names to dates or something similar after you copy them to your computer. If you later decided to return a DCIM folder to the camera, however, be sure to change its name back to DCIM. The camera is designed to recognize only a root file with the name DCIM. Note the camera also will not be able to recognize the folders inside the DCIM folder unless they have the names they originally had when you copied them from the camera to your computer.
- Folders and files must be stored in accordance with the "Memory Folder Structure" shown on page 153 in order for the camera to be able to recognize them correctly.

Other Settings (SETTING)

This section explains menu items that you can use to configure settings and perform other operations in both the REC mode and PLAY mode.

For information about menu operations, see page 92.

Enabling Power Saving (ECO Mode)

Procedure

[MENU] → “ SETTING” Tab → ECO Mode

Enabling power saving reduces the brightness of the monitor screen and switches other camera operations to low-power operation, which allows a charge to last longer and increases the number of images that can be shot between charges.

Selecting “On” enters the “ECO Mode”, which is indicated by  on the monitor screen. The power saving effect of the “ECO Mode” is most efficient when “Auto” is selected for the recording mode. Use the “Auto” recording mode is recommended when using the “ECO Mode”.

NOTE

- You can achieve even greater power savings by using the “ECO Mode” in combination with Auto Power Off (page 159) and Sleep (page 159).

Adjusting Monitor Screen Brightness (Screen)

Procedure

[MENU] → “ SETTING” Tab → Screen

Auto	With this setting, the camera detects available light levels and automatically adjusts the brightness of the monitor screen accordingly.
+2	Brightness that is greater than +1, which makes the screen easier to view. This setting consumes more power.
+1	Bright setting for outdoor use, etc. Brightness that is greater than 0.
0	Normal monitor screen brightness for indoor use, etc.
-1	Low monitor screen brightness for nighttime use, indoor use under dark conditions, etc.

- Turning on the “ECO Mode” (page 155) while the “Screen” setting is +2 or +1 will cause the “Screen” setting to change to 0.

Turning off Eye-Fi Card Communication (Eye-Fi)

Procedure

[MENU] → “ SETTING” Tab → Eye-Fi

Select “Off” to disable Eye-Fi card communication (page 148).

Configuring FlashAir Card Communication Settings (FlashAir)

Procedure

[MENU] → “ SETTING” Tab → FlashAir

Selecting “Start with the control image” for the FlashAir card setting and selecting “On” for the camera’s “FlashAir” setting will establish a FlashAir wireless LAN connection (page 150).

- If the FlashAir card’s “Start automatically at boot” setting is selected, a wireless LAN connection will be established automatically whenever the camera is turned on.

Configuring Camera Sound Settings (Sounds)

Procedure

[MENU] → “ SETTING” Tab → Sounds

Startup	
Half Shutter	Specifies the startup sound Sound 1 - 5: Built-in sounds (1 through 5)
Shutter	Off: Sound off
Operation	
Operation Vol	Specifies the sound volume. This setting is also used as the audio level during video output (page 117).
Playback Vol	Specifies the volume of movie audio output. This volume setting is not used during video output (from the USB/AV port) (page 117).

- Setting a volume level of 0 mutes output.

Creating an Image Storage Folder (Create Folder)

Procedure

[MENU] → “⚙️ SETTING” Tab → Create Folder

Create Folder	Creates a folder with a unique number (page 152). Files will be stored in the new folder starting from when you record your next image.
Cancel	Cancels folder creation.

- Images recorded with the BEST SHOT “For eBay” or “Auction” scene, and the “For YouTube” scene are stored in special folders. They are not stored in the folder you create here.
- Deleting all of the files in a folder cause the folder to be deleted as well.

Time Stamping Snapshots (Timestamp)

Procedure

[MENU] → “⚙️ SETTING” Tab → Timestamp

You can configure the camera to stamp the recording date only, or date and time in the lower right corner of each snapshot.

- Once date and time information is stamped into a snapshot, it cannot be edited or deleted.

Example: July 10, 2015, 1:25 p.m.

Date	2015/7/10
Date & Time	2015/7/10 1:25pm
Off	No stamping of date and/or time

- Even if you do not stamp the date and/or time with Timestamp, you can do so later using the DPOF function or some printing application (page 138).
- Stamping is performed in accordance with the date and time settings (page 162) and the display style settings (page 162).

Auto Image Orientation Detection and Rotation (Auto Rotate)

Procedure

[MENU] → “ SETTING” Tab → Auto Rotate

On	Automatically rotates snapshots shot with the camera held vertically 90 degrees.
Off	Images not rotated automatically.

The camera automatically detects whether a snapshot image was shot in portrait or landscape orientation and displays it accordingly.

Specifying the File Name Serial Number Generation Rule (File No.)

Procedure

[MENU] → “ SETTING” Tab → File No.

Use the following procedure to specify the rule that governs generation of the serial number used in file names (page 152).

Continue	Tells the camera to remember the last used file number. A new file will be named using the next sequential number, even if files are deleted or if a blank memory card is loaded. If a memory card is loaded and that card already has files stored on it and the largest sequential number in the existing file names is greater than the largest sequential number remembered by the camera, numbering of new files will start from the largest sequential number in the memory card file names plus 1.
Reset	Restarts the serial number from 0001 whenever all files are deleted or when the memory card is replaced with a blank one. If a memory card is loaded and that card already has files stored on it, numbering of new files will start from the largest sequential number in the memory card file names plus 1.

Configuring Sleep State Settings (Sleep)

Procedure

[MENU] → “**⚙️ SETTING**” Tab → **Sleep**

This feature turns off the monitor screen and lights the back lamp (green) whenever no camera operation is performed for a preset period of time. Press any button to turn the monitor screen back on.

Trigger Time Settings: 30 sec, 1 min, 2 min, Off (Sleep is disabled while “Off” is selected.)

- Sleep is disabled under any of the following conditions.
 - In the PLAY mode
 - While the camera is connected to a computer, TV, or other device
 - During movie recording and playback
- When both sleep and Auto Power Off are turned on, Auto Power Off takes priority.

Configuring Auto Power Off Settings (Auto Power Off)

Procedure

[MENU] → “**⚙️ SETTING**” Tab → **Auto Power Off**

Auto Power Off turns off the camera whenever no camera operation is performed for a preset amount of time.

Trigger Time Settings: 2 min, 5 min, 10 min (The trigger time is always 5 minutes in the PLAY mode.)

- Auto Power Off is disabled under any of the following conditions.
 - While the camera is connected to a computer or other device
 - During a slideshow
 - During CS group playback
 - During movie recording and playback

Configuring [📷] Setting (REC)

Procedure

[MENU] → “⚙️ SETTING” Tab → REC

Power On	Camera turns on whenever [📷] (REC) is pressed.
On/Off	Camera turns on or off whenever [📷] (REC) is pressed.
Off	Camera does not turn on or off when [📷] (REC) is pressed.

- With “On/Off”, the camera turns off when you press [📷] (REC) in the REC mode.

Configuring [▶] Setting (PLAY)

Procedure

[MENU] → “⚙️ SETTING” Tab → PLAY

Power On	Camera turns on whenever [▶] (PLAY) is pressed.
On/Off	Camera turns on or off whenever [▶] (PLAY) is pressed.
Off	Camera does not turn on or off when [▶] (PLAY) is pressed.

- With “On/Off”, the camera turns off when you press [▶] (PLAY) in the PLAY mode.

Disabling File Deletion (Delete Key)

Procedure

[MENU] → “⚙️ SETTING” Tab → Delete Key

The camera will not start the image delete operation when you press [▼] (🗑️) while “Delete Key” is turned on.

You can protect against accidental deletion of images by selecting “Disabled” for “Delete Key”.

- Performing a format operation (page 165) will cause all images to be deleted, even if file deletion is disabled (“Disabled” selected for “Delete Key”) for some images.

Configuring World Time Settings (World Time)

Procedure

[MENU] → “ SETTING” Tab → World Time

You can use the World Time screen to view the current time in a zone that is different from your Home City when you go on a trip, etc. World Time displays the current time in 162 cities in 32 time zones around the globe.

1. Use [▲] and [▼] to select “Destination” and then press [▶].

- To change the geographic area and city for the time where you normally use the camera, select “Home”.

2. Use [▲] and [▼] to select “City” and then press [▶].

- To change the “Destination” setting to summer time, use [▲] and [▼] to select “DST” and then select “On”. Summer time is used in some geographical areas to advance the current time setting by one hour during the summer months.

3. Use [▲] and [▼] to select the geographic area you want and then press [SET].

4. Use [▲] and [▼] to select the city you want and then press [SET].

5. Press [SET].



IMPORTANT!

- Before configuring World Time settings, make sure that the Home City setting is the place where you live or normally use the camera. If it isn't, select “Home” on the screen in step 1 and configure the Home City, date, and time settings as required (page 162).

Setting the Camera's Clock (Adjust)

Procedure

[MENU] → “ SETTING” Tab → Adjust

When the date and time settings are what you want, select “Apply” and then press [SET] to apply them.

[▲] [▼]	Change the setting at the cursor location
[◀] [▶]	Move the cursor between settings

- To switch between 12-hour and 24-hour timekeeping, move the cursor to the current setting (“am (pm)” or “24h”) and then use [▲] or [▼] to change the setting.
- You can specify a date from 2001 to 2049.
- Be sure to select your Home City (page 161) before setting the time and date. If you set the time and date while the wrong city is selected for your Home City, the times and dates of all of the World Time cities (page 161) will be wrong.

Specifying the Date Style (Date Style)

Procedure

[MENU] → “ SETTING” Tab → Date Style

You can select from among three different styles for the date.

Example: July 10, 2015

YY/MM/DD	15/7/10
DD/MM/YY	10/7/15
MM/DD/YY	7/10/15

Specifying the Display Language (Language)

Procedure

[MENU] → “ SETTING” Tab → Language

■ Specify the display language you want.

- ① Select the bottom tab “”.
 - ② Select “Language”.
 - ③ Select the language you want.
- Camera models sold in certain geographic areas may not support display language selection.



Configuring USB Protocol Settings (USB)

Procedure

[MENU] → “ SETTING” Tab → USB

You can use the procedure below to select the USB communication protocol, which is used when exchanging data with a computer, printer, or other external device.

Mass Storage	Select this setting when connecting to a computer (pages 142, 146). With this setting, the computer sees the camera as an external storage device. Use this setting for normal transfer of images from the camera to a computer.
PictBridge	Select this setting when connecting to a printer that supports PictBridge (page 133).

Selecting the Screen Aspect Ratio and Video Output System (Video Out)

Procedure

[MENU] → “ SETTING” Tab → Video Output

You can use the procedure in this section to select either NTSC or PAL as the video output system. You can also specify an aspect ratio of 4:3 or 16:9.

NTSC	Video system used in Japan, the U.S., and other countries
PAL	Video system used in Europe and other areas
4:3	4:3 aspect ratio
16:9	Wide screen aspect ratio

- Select the aspect ratio (4:3 or 16:9) that matches the type of TV you plan to use. Images will not display correctly if you select the wrong aspect ratio.
- Images will not display correctly unless the camera's video signal output setting matches the video signal system of the TV or other video equipment.
- Images cannot be displayed correctly on a TV or video equipment that is not NTSC or PAL.

Selecting the HDMI Terminal Output Method (HDMI Output)

Procedure

[MENU] → “ SETTING” Tab → HDMI Output

- See page 119 for details.

Formatting Built-in Memory or a Memory Card (Format)

Procedure

[MENU] → “ SETTING” Tab → **Format**

If a memory card is loaded in the camera, this operation will format the memory card. It will format built-in memory if no memory card is loaded.

- The format operation will delete all contents on the memory card or in built-in memory. It cannot be undone. Make sure you do not need any data currently on the card or in built-in memory before you format it.
- Formatting built-in memory will delete the following data.
 - Protected images
 - “CUSTOM SHOT” setups
- Formatting a memory card will delete the following data.
 - Protected images
- Formatting will cause all images to be deleted, even if file deletion is disabled (“Disabled” selected for “Delete Key” (page 160)) for some images.
- Check the battery level before starting a format operation and make sure it is not too low. Formatting may not be performed correctly and the camera may stop operating normally if the camera powers down while formatting is in progress.
- Never open the battery cover while formatting is in progress. Doing so can cause the camera to stop operating normally.

Resetting the Camera to Factory Defaults (Reset)

Procedure

[MENU] → “ SETTING” Tab → **Reset**

See page 180 for details about the camera’s factory default settings.

The settings below are not reset.

World Time settings, clock settings, date style, screen language, video output

Safety Precautions

DANGER

This symbol indicates information that, if ignored or applied incorrectly, creates the danger of death or serious personal injury.

WARNING

This indication stipulates matters that have the risk of causing death or serious injury if the product is operated incorrectly while ignoring this indication.

CAUTION

This indication stipulates matters that have the risk of causing injury as well as matters for which there is the likelihood of occurrence of physical damage only if the product is operated incorrectly while ignoring this indication.

Symbol Examples





This circle with a line through it (⊘) means that the indicated action must not be performed. Indications within or nearby this symbol are specifically prohibited. (The example at left indicates that disassembly is prohibited.)







The black dot (●) means that the indicated action must be performed. Indications within this symbol are actions that are specifically instructed to be performed. (The example at left indicates that the power plug must be unplugged from the electrical socket.)

DANGER

■ Rechargeable Battery

- To charge the battery, use only the method specifically described in this manual. Attempting to charge the battery by an unauthorized means creates the risk of battery overheating, fire, and explosion. 
- Do not expose or immerse the battery in fresh water or salt water. Doing so can damage the battery, and cause deterioration of its performance and loss of service life. 
- The battery is intended for use with a CASIO Digital Camera only. Use with any other device creates the risk of the battery damage, or deterioration of battery performance and service life. 

 **DANGER**

- Failure to observe any of the following precautions creates the risk of battery overheating, fire, and explosion.
 - Never use or leave the battery near open flame. 
 - Do not expose the battery to heat or fire.
 - Make sure the battery is oriented correctly when charging it.
 - Never carry or store the battery together with items that can conduct electricity (necklaces, pencil lead, etc.).
 - Never disassemble the battery, pierce it with a needle, or expose it to strong impact (hit it with a hammer, step on it, etc.), and never apply solder to it. Never place the battery into a microwave oven, dehumidifier, high-pressure generating device, etc.
 - Never remove the outer sticker from the battery.
- Should you ever notice leakage, strange odor, heat generation, discoloration, deformation, or any other abnormal condition while using, charging, or storing a battery, immediately remove it from the camera and keep it away from open flame. Also, do not use the affected battery after the abnormal symptoms disappear. 
- Do not use or leave the battery under direct sunlight, in an automobile parked in the sun, or in any other area subject to high temperatures. Doing so can damage the battery, and cause deterioration of its performance and loss of service life. Also, these conditions can cause the battery to swell to the point that you may not be able to remove it. 
- Battery fluid can damage your eyes. Should battery fluid get into your eyes accidentally, immediately rinse them with clean tap water and then consult a physician. 

 **WARNING**

■ **Smoke, abnormal odor, overheating, and other abnormalities**

- Continued use of the camera while it is emitting smoke or strange odor, or while it is overheating creates the risk of fire and electric shock. Immediately perform the following steps whenever any of the above symptoms are present.



1. Turn off the camera.
2. If you are using the USB-AC adapter to power the camera, unplug the power cord plug from the power outlet. Also, remove the battery from the camera, taking care to protect yourself against burn injury.
3. Contact your retailer or nearest CASIO authorized service center.

■ **Keep Away From Fire**

- Never expose the camera to fire, which can cause it to explode and creates the risk of fire and personal injury.



■ **Avoid Use While In Motion**

- Never use the camera to record or play back images while operating an automobile or other vehicle, or while walking. Looking at the monitor while in motion creates the risk of serious accident.



■ **Flash and Other Light Emitting Functions**

- Never use light emitting functions in areas where there is the chance of flammable or explosive gas being present. Such conditions create the risk of fire and explosion.
- Never fire the flash or use light emitting functions pointed in the direction of a person operating a motor vehicle. Doing so can interfere with the driver's vision and create the risk of accident.









■ **USB-AC Adapter**

- The power cord that comes with the camera is designed for use in the country where the camera was purchased. If you use the camera in another country, be sure to use a power cord that conforms to that country's ratings and power supply voltage. Use of an improper power cord creates the risk of fire and electric shock.
- Misuse of USB-AC adapter creates the risk of fire and electric shock. Be sure to observe the following precautions.
 - Use only the specified USB-AC adapter.
 - Never use the USB-AC adapter with another device.
 - Use a power outlet that matches the power supply specified for the USB-AC adapter.
 - Never plug the power cord into a wall outlet that is shared by other devices, or into a shared extension cord.
 - Never locate the USB-AC adapter near a stove or other heating device.



 **WARNING**

- Misuse of the USB-AC adapter can cause them to become damaged, creating the risk of fire and electric shock. Be sure to observe the following precautions.
 - Never place heavy objects on the USB-AC adapter or subject it to direct heat. 
 - Do not modify the USB-AC adapter, allow it to become damaged, or forcibly bend it.
 - Do not twist or pull on the USB-AC adapter cord.
 - When in use, locate the cord where it will not be tripped over.
- Never touch the power plug while your hands are wet. Doing so creates the risk of electric shock. 
- Should the power cord or power plug become damaged, contact your retailer or nearest CASIO authorized service center. 
- Do not use the USB-AC adapter in areas where liquids* might spill on them. Liquids create the risk of fire and electric shock. 
- * Liquids: Water, sports drinks, seawater, animal or pet urine, etc.
- Do not place a flower vase or any other liquid container on top of the USB-AC adapter. Water creates the risk of fire and electric shock. 
- Do not touch the camera or USB-AC adapter during lightning storms. 
- Before going out, be sure to unplug the USB-AC adapter from the power outlet and put in a place away from objects used by animals and pets. An animal or pet chewing on the power cord can cause it short, leading to the risk of fire. 

■ **Water and Foreign Matter**

- Water, other liquids, or foreign matter (especially metal) getting inside the camera creates the risk of fire and electric shock. Immediately perform the following steps whenever any of the above symptoms are present. Particular care is required when using the camera where it is raining or snowing, near the ocean or other body of water, or in a bathroom. 
 1. Turn off the camera.
 2. If you are using the USB-AC adapter to power the camera, unplug the power plug from the wall outlet. Also, remove the battery from the camera, taking care to protect yourself against burn injury.
 3. Contact your retailer or nearest CASIO authorized service center.

■ **Disassembly and Modification**

- Never try to take the camera apart or modify it in any way. Doing so creates the risk of electric shock, burn injury, and other personal injury. Be sure to leave all internal inspection, maintenance, and repair up to your retailer or nearest CASIO authorized service center. 

 **WARNING**

■ **Dropping and Rough Treatment**

- Continued use of the camera after it is damaged by dropping or other rough treatment creates the risk of fire and electric shock. Immediately perform the following steps whenever any of the above symptoms are present. 
 1. Turn off the camera.
 2. If you are using the USB-AC adapter to power the camera, unplug the power plug from the wall outlet. Also, remove the battery from the camera, taking care to protect yourself against burn injury.
 3. Contact your retailer or nearest CASIO authorized service center.

■ **Memory Cards**



- Memory cards are small and present a risk of accidentally being swallowed by infants and young children. Keep memory cards out of the reach of infants and young children. If a memory card is ever swallowed accidentally, contact a physician immediately. 

■ **Precaution when Camera is On**

- Do not touch the camera for long periods while it is on. The camera becomes warm when on, and long term contact creates the risk of low-temperature burns. 





 **CAUTION**

■ **USB-AC Adapter**

- Misuse of the USB-AC adapter creates the risk of fire and electric shock. Make sure you observe the following precautions. 
 - Never cover the USB-AC adapter or power cord with a quilt, blanket, or other cover while it is in use, and do not use it near a heater. Doing so can interfere with heat radiation and cause the area around them to become hot.
 - When unplugging from the wall outlet, never pull on the power cord. Grasp the power plug and pull.
 - Do not use detergent when cleaning the power cord (especially the plug), the USB-AC adapter (especially the jack), or the USB cable (especially the plug).
 - Insert the power plug into the wall outlet as far as it will go.
 - Unplug the power plug from the wall outlet before leaving the camera unattended for long periods, such as when leaving on a trip, etc. 
 - At least once a year, use a cloth or vacuum cleaner to clean any dust build up on the prongs of the power plug and in the area around them.

 **CAUTION**

■ **Rechargeable Battery**

- If battery charging does not end normally within the specified charging time, stop charging anyway and contact your local CASIO authorized service center. Continued charging creates the risk of battery overheating, fire, and explosion. 
- Be sure to read the user documentation that comes with the camera and special charger unit before using or charging the battery. 
- Store batteries in a location that cannot be reached by infants and young children. When using a battery where infants and young children are present, be on guard to ensure that they do not have the chance to remove the battery from the charger unit or camera. 
- Do not leave batteries near areas used by pets. A pet chewing on a battery can lead to accidents caused by the battery leaking, overheating, or exploding. 
- Should fluid from a battery accidentally get onto clothing or your skin, immediately rinse it off with clean tap water. Prolonged contact with battery fluid can cause skin irritation. 

■ **Connections**

- Never plug any devices that are not specified for use with this camera into connectors. Connecting a non-specified device creates the risk of fire and electric shock. 

■ **Unstable Locations**





- Never place the camera on an unstable surface, on a high shelf, etc. Doing so can cause the camera to fall, creating the risk of personal injury. 

■ **Locations To Be Avoided**

- Never leave the camera in any of the following types of locations. Doing so creates the risk of fire and electric shock. 
 - Areas subject to large amounts of humidity or dust
 - Food preparation areas or other locations where oil smoke is present
 - Near heaters, on a heated carpet, in areas exposed to direct sunlight, in a closed vehicle parked in the sun, or other areas subject to very high temperatures

 **CAUTION**

■ **Monitor Screen**

- Do not apply strong pressure to the LCD panel surface or subject it to strong impact. Doing so can cause the display panel glass to crack and lead to personal injury. 
- Should the monitor screen ever become cracked, never touch any of the liquid inside the monitor screen. Doing so creates the risk of skin inflammation. 
- Should monitor screen liquid ever get into your mouth, immediately rinse your mouth out and contact your physician. 
- Should monitor screen liquid ever get into your eyes or onto your skin, immediately rinse with clean water for at least 15 minutes and contact your physician. 



■ **Backing Up Important Data**

- Always keep backup copies of important data in camera memory by transferring it to a computer or other storage device. Note that data can be deleted in the case of camera malfunction, repair, etc. 

■ **Memory Protection**

- Whenever replacing the battery, be sure to follow the correct procedure as described in the documentation that comes with the camera. Incorrectly replacing the battery can result in corruption or loss of data in camera memory. 

■ **Flash and Other Light Emitting Functions**

- Never fire the flash or use light emitting functions pointed in the direction of and too close to a person's face. Doing so creates the risk of loss of eyesight. In the case of infants and young children in particular, keep the light source at least one meter away the eyes. 
- Do not touch the flash unit when it is firing. Doing so creates the risk of burn injury. 

■ **Transport**

- When in an aircraft or medical facility, comply with instructions of personnel in charge. Electromagnetic waves and other signals emitted by the camera can adversely affect other equipment. 

Precautions During Use

■ Data Error Precautions

Your digital camera is manufactured using precision digital components. Any of the following creates the risk of corruption of data in camera memory.

- Removing the battery or memory card while the camera is performing some operation
- Removing the battery or memory card while the back lamp is flashing green after turning off the camera
- Disconnecting the USB cable while communication is in progress
- Shooting with a battery that quickly goes low right after it is charged
 - Shooting with a battery that quickly goes low right after it is charged can also cause camera malfunction. Replace the battery with a new one immediately.
- Other abnormal operations

Any of the above conditions can cause an error message to appear on the monitor screen (page 189). Perform the action indicated by the message that appears.

■ Operating Environment

- Operating Temperature Requirements: 0 to 40°C (32 to 104°F)
- Operating Humidity: 10 to 85% (non condensation)
- Do not place the camera in any of the following locations.
 - In an area exposed to direct sunlight, or large amounts of moisture, dust, or sand
 - Near heating or cooling devices, or in other areas subjected to extreme changes in temperature or humidity
 - Inside of a motor vehicle on a hot day, or in an area subjected to strong vibration

■ Condensation

Sudden and extreme temperature changes, such as when the camera is moved from the outdoors on a cold winter day into a warm room, can cause water droplets called “condensation” to form on the interior and the exterior of the camera, which creates the risk of malfunction. To prevent condensation from forming seal the camera in a plastic bag before changing locations. Then leave the bag sealed to allow the air inside to naturally change to the same temperature as the air in the new location. After that, remove the camera from the bag and open the battery cover for a few hours.

■ Lens

- Never apply too much force when cleaning the surface of the lens. Doing so can scratch the lens surface and cause malfunction.
- You may sometimes notice some distortion in certain types of images, such as a slight bend in lines that should be straight. This is due to the characteristics of lenses, and does not indicate malfunction of the camera.

■ Caring for your camera

- Never touch the lens or flash window with your fingers. Finger smudges, dirt, and other foreign matter on the lens or flash window can interfere with proper operation of the camera. Use a blower or other means to keep the lens and flash window free of dirt and dust, and wipe gently with a soft, dry cloth.
- To clean the camera, wipe it with a soft, dry cloth.

■ Old Rechargeable Battery Handling Precautions

- Insulate the positive and negative terminals with tape, etc.
- Do not peel the covering off of the battery.
- Do not try to take the battery apart.

■ Discarding or Transferring Ownership of a Memory Card or the Camera

The format and delete functions of the camera do not actually delete files from the memory card. The original data remains on the card. Note that responsibility for the data on a memory card lies with you. The following procedures are recommended whenever you discard a memory card or the camera, or if you transfer ownership to another party.

- When discarding a memory card, either physically destroy the memory card or use commercially available data delete software to completely delete the data on the memory card.
- When transferring ownership of a memory card to another party, use commercially available data deletion software to completely delete the data on it.
- Use the format function (page 165) to completely delete the data in built-in memory before discarding or transferring ownership of the camera.

■ Other Precautions

The camera becomes slightly warm during use. This is normal and does not indicate malfunction.

■ Copyrights

Except for your own personal enjoyment, unauthorized use of snapshots or movies of images whose rights belong to others, without the permission of the right holder, is forbidden by copyright laws. In some cases, shooting of public performances, shows, exhibitions, etc. may be restricted entirely, even if it is for your own personal enjoyment. Regardless of whether such files are purchased by you or obtained for free, posting them on a website, a file sharing site, or any other Internet site, or otherwise distributing them to third parties without the permission of the copyright holder is strictly prohibited by copyright laws and international treaties. For example, uploading or distributing on the Internet images of TV programs, live concerts, music videos, etc. that were photographed or recorded by you may infringe upon the rights of others. Note that CASIO COMPUTER CO., LTD. shall not be held liable for use of this product in any way that infringes on the copyrights of others or that violates copyright laws.

The following terms, which are used in this manual, are registered trademarks or trademarks of their respective owners.

Note that trademark [™] and registered trademark [®] are not used within the text of this manual.

- SDXC Logo is a trademark of SD-3C, LLC.
- Microsoft, Windows, Internet Explorer, Windows Media, Windows Vista, Windows 7, Windows 8, and DirectX are registered trademarks or trademarks of Microsoft Corporation in the United States and other countries.
- Macintosh, Mac OS, QuickTime, and iPhoto are trademarks of Apple Inc.
- YouTube and the YouTube logo are trademarks or registered trademarks of Google Inc.
- HDMI, the HDMI logo, and High-Definition Multimedia Interface are trademarks or registered trademarks of HDMI Licensing, LLC.
- Eye-Fi and the Eye-Fi logo are trademarks of Eye-Fi, Inc.
- FlashAir and the FlashAir logo are trademarks of TOSHIBA CORPORATION.
- EXILIM is a registered trademark of CASIO COMPUTER CO., LTD.
- All other company or product names mentioned herein are registered trademarks or trademarks of their respective companies.

Any and all unauthorized copying, distribution, and transfer for commercial purposes of the software provided by CASIO for this product are prohibited.

The camera's YouTube recording function is provided under license granted by YouTube, LLC.

Charging

■ If the camera's back lamp starts flashing red...

If the back lamp starts flashing red during charging, it means that further charging is not possible for one of the reasons below. Perform the actions described below to correct the problem and then try charging again.

Ambient temperature or the temperature of the battery is abnormally high or low

Unplug the USB cable from the camera and wait for a while until the camera is within the temperature range of 10°C to 35°C (50°F to 95°F), and then try charging again.

Safety timer activated

A battery that has not been used for a long time, certain types of computers, and connection conditions can cause charging to take longer than normal. If charging takes longer than about 6 hours, a safety timer will terminate it automatically, even if the battery is not fully charged. If the battery has not been used for a very long time, charging may terminate automatically after only about 45 minutes.

- 1) Using a battery that has not been used for a long time.
Disconnect and then reconnect the USB cable to resume charging.
- 2) Insufficient power supply when connected to computer
The camera can be charged only via a USB 2.0 standard USB port. Connect directly to a USB port what supplies a current of 500mA.

For details about the power supply capacity of a computer's USB port, contact the manufacturer of the computer. Though disconnecting and then reconnecting the USB cable will resume charging, you may need to do so repeatedly if the power supply capacity of the computer is low.

If problems persist after you perform the above steps or if the battery fails to charge after 6 hours, it could mean that the battery is faulty. Contact your nearest CASIO authorized service center.

Battery Precautions

■ Precautions during Use

- Operation provided by a battery under cold conditions is always less than operation under normal temperatures. This is due to the characteristics of the battery, not the camera.
- Charge the battery in an area where the temperature is within the range of 10°C to 35°C (50°F to 95°F). Outside this temperature range charging can take longer than normal or even fail.
- Do not tear or remove the battery outer label.
- If a battery provides only very limited operation following a full charge, it probably means the battery has reached the end of its service life. Replace the battery with a new one.

■ Storage Precautions

- Storing the battery for a long time while it is charged can cause deterioration of battery characteristics. If you do not plan to use a battery for some time, fully use up its charge before storing it.
- Always remove the battery from the camera when you are not using it. A battery left in the camera can discharge and go dead, which will require some time to charge when you need to use the camera.
- Store batteries in a cool, dry place (20°C (68°F) or lower).
- To prevent over discharging of an unused battery, fully charge it, and then load it in the camera and fully use up the charge about once every six months.

Using the Camera in another Country

■ Precautions during Use

- The bundled USB-AC adaptor is designed for operation with any power supply in the range of 100V to 240V AC, 50/60Hz. Note, however, that the shape of the power cord plug depends on each country or geographic area. Before taking the camera and USB-AC adaptor along on a trip, check with travel agent about the power supply requirements in your destination(s).
- Do not connect the USB-AC adaptor to a power supply through a voltage converter or similar device. Doing so can lead to malfunction.

■ Extra Batteries

- Taking along extra fully charged batteries (NP-130) is recommended while on a trip in order to avoid not being able to shoot images due to the battery going dead.

Using a Memory Card

See page 23 for information about supported memory cards and how to load a memory card.

■ Using a Memory Card

- SD memory cards, SDHC memory cards, and SDXC memory cards have a write protect switch. Use the switch when you need to guard against accidentally deleting data. Note, however, if you write protect an SD memory card you must then turn write protection off whenever you want to record to it, format it, or delete any of its images.
- If a memory card starts to behave abnormally during image playback, you can restore normal operation by reformatting it (page 165). However, it is recommended that you always take along multiple memory cards whenever using the camera far away from the home or office.
- As you record data to and delete data from a memory card a number of times, it loses its ability to retain data. Because of this, periodic re-formatting of a memory card is recommended.
- Electrostatic charge, electrical noise, and other phenomena can cause data to become corrupted or even lost. Make sure that you always back up important data on other media (CD-R, CD-RW, hard disk, etc.).

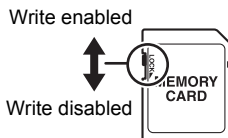

■ Memory Card Handling Precautions

Certain types of memory cards can slow down processing speed. Whenever possible use an Ultra High-Speed Type memory card. Note, however, that not all operations can be guaranteed even if an Ultra High-Speed Type memory card is used. Certain movie quality settings can result in too much time being required to record data, which can result in breaks in the image and/or audio during playback. If this happens, the **REC** will turn yellow on the monitor screen.

■ Discarding or Transferring Ownership of a Memory Card or the Camera

The format and delete functions of the camera do not actually delete files from the memory card. The original data remains on the card. Note that responsibility for the data on a memory card lies with you. The following procedures are recommended whenever you discard a memory card or the camera, or if you transfer ownership to another party.

- When discarding a memory card, either physically destroy the memory card or use commercially available data delete software to completely delete the data on the memory card.
- When transferring ownership of a memory card to another party, use commercially available data deletion software to completely delete the data on it.

Use the format function (page 165) to completely delete the data in built-in memory before discarding or transferring ownership of the camera.

Reset Initial Default Settings

The tables in this section show the initial default settings that are configured for menu items (displayed when you press [MENU]) after you reset the camera (page 165).

Menu items depend on whether the camera is in the REC mode or PLAY mode.

- A dash (–) indicates an item whose setting is not reset or an item for which there is no reset setting.



IMPORTANT!

- Depending on the recording mode, some of the items on the menu that appears may not be usable.

■ REC MENU

L/R Key	Off
Double (HDR Art)	On
Image Size	16M
Image Quality	Normal
Movie Quality	FHD
ISO	Auto
ISO High Limit	Auto
Zoom (SR)	Single
AF Area	Spot
Anti Shake	On
Lighting	On
Continuous AF	Off
Face Detection	Off
Digital Zoom	On
Wind Noise Cut	Off
Make-up Level	Depends on the recording mode.
EV Shift	0.0
White Balance	Auto WB
Focus	AF
Self-timer	Off
Metering	Multi
Flash Intensity	0
Sharpness	0
Saturation	0

Contrast	0
AF Assist Light	On
Grid	Off
Review	Type 2
Icon Help	On
Memory	High Speed CS: Off / Flash: On / Focus: Off / ISO: Off / White Balance: Off / EV Shift: Off / AF Area: On / Metering: Off / Self-timer: Off / Flash Intensity: Off / Zoom (SR): On / Digital Zoom: On / MF Position: Off / Zoom Position: Off

■ PLAY MENU

Slideshow	Images: All images / Time: 30 min / Interval: 3 sec / Effect: Pattern 1
MOTION PRINT	Create
Movie Editing	–
Lighting	–
White Balance	–
Brightness	–
DPOF Printing	–

Protect	–
Date/Time	–
Rotation	–
Resize	–
Trimming	–
Copy	–
Divide Group	–
CS Multi Print	–
CS Frame Edit	–

■ SETTING

ECO Mode	Off
Screen	Auto
Eye-Fi	On
FlashAir	On
Sounds	Startup: Sound 1 / Half Shutter: Sound 1 / Shutter: Sound 1 / Operation: Sound 1 /Operation Vol: 3 / Playback Vol: 3
Create Folder	–
Timestamp	Off
Auto Rotate	On
File No.	Continue

Sleep	1 min
Auto Power Off	5 min
REC	Off
PLAY	Power On
Delete Key	Enabled
World Time	–
Adjust	–
Date Style	–
Language	–
USB	Mass Storage
Video Output	–
HDMI Output	Auto
Format	–
Reset	–

Using the On-screen Histogram to Check Exposure (+Histogram)

Displays a histogram on the monitor screen which you can use to check the exposure of an image before you shoot it. You also can display the histogram in the PLAY mode for information about the exposure levels of images.

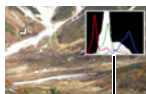

Histogram

NOTE

- A centered histogram does not necessarily guarantee optimum exposure. The recorded image may be over-exposed or under-exposed, even though its histogram is centered.
- Due to the limitations of exposure compensation, you may not be able to achieve an optimum histogram configuration.
- Use of the flash and certain shooting conditions can cause the histogram to indicate exposure that is different from the actual exposure of the image when it is shot.
- The histogram cannot be displayed during high speed movie recording.

■ How to Use the Histogram

A histogram is a graph that represents the lightness of an image in terms of the number of pixels. The vertical axis indicates the number of pixels, while the horizontal axis indicates lightness. If the histogram appears too lopsided for some reason, you can use EV shift to move it left or right in order to achieve better balance. Optimum exposure can be achieved by EV shifting so the graph is as close to the center as possible. For snapshots, you can even display individual histograms for R (red), G (green), and B (blue).

Example Histograms

A histogram towards the left side results when the overall image is dark. A histogram that is too far to the left may result in “black out” of the dark areas of an image.



A histogram towards the right side results when the overall image is light. A histogram that is too far to the right may result in “white out” of the light areas of an image.















An overall well-balanced histogram results when the overall image is at optimal lightness.



Troubleshooting

Problem	Possible Cause and Recommended Action
Power Supply	
Power does not turn on.	<ol style="list-style-type: none"> 1)The battery may not be loaded correctly (page 16). 2)The battery may be dead. Charge the battery (page 17). If the battery goes dead soon after being charged, it means the battery has reached the end of its life and needs to be replaced. Purchase a separately available CASIO NP-130 rechargeable lithium ion battery.
The camera suddenly powers down.	<ol style="list-style-type: none"> 1)Auto Power Off may have activated (page 159). Turn power back on. 2)The battery may be dead. Charge the battery (page 17). 3)The camera's protection function may have activated because camera temperature is too high. Turn off the camera and wait until it cools down before trying to use it again.
Power will not turn off. Nothing happens when a button is pressed.	Remove the battery from the camera and then reload them.
Image Recording	
Image is not recorded when the shutter button is pressed.	<ol style="list-style-type: none"> 1)If the camera is in the PLAY mode, press the shutter button to enter the REC mode. 2)If the flash is charging, wait until the charge operation finishes. 3)If the message "Memory Full" appears, transfer images to your computer, delete images you no longer need, or use a different memory card.
Auto Focus does not focus properly.	<ol style="list-style-type: none"> 1)If the lens is dirty, clean it off. 2)The subject may not be in the center of the focus frame when you compose the image. 3)The subject you are shooting may not be a type that is compatible with Auto Focus (page 35). Use manual focus (page 43). 4)You may be moving the camera when shooting. Try shooting with Anti Shake or use a tripod.

Problem	Possible Cause and Recommended Action
The subject is out of focus in the recorded image.	The image may not be focused properly. When composing the image, make sure the subject is located inside the focus frame.
The flash does not fire.	1) If  (Flash Off) is selected as the flash mode, change to another mode (page 48). 2) If the battery is low, charge it (page 17). 3) If a BEST SHOT scene that uses  (Flash Off) is selected, change to a different flash mode (page 48) or select a different BEST SHOT scene (page 74).
The red  (Flash Off) icon is displayed on the monitor screen and the flash does not fire.	The flash unit may be malfunctioning. Contact a CASIO authorized service center or your original retailer. Note that though the flash will not fire, you still can use the camera for non-flash shots.
Camera powers down during Self-timer countdown.	The battery may be low. Charge the battery.
The monitor screen image is out of focus.	1) You may be using Manual Focus and have not focused the image. Focus the image (page 42). 2) You may be using  (Macro) or  (Super Macro) for scenery or portraits. Use Auto Focus for scenery and portrait shots (page 42). 3) You may be trying to use Auto Focus or  (Infinity Focus) when shooting a close-up shot. Use the  (Macro) or  (Super Macro) for close ups (page 42).
There is digital noise in images.	1) Sensitivity may have been increased automatically for a dark subject, which increases the chance of digital noise. Use a light or some other means to illuminate the subject. 2) You may be attempting to shoot in a dark location with  (Flash Off) selected, which can increase digital noise and make images appear coarse. In this case, turn on flash (page 48) or use lights for illumination. 3) Lighting (page 101) may be enabled for snapshots, which can cause an increase in digital noise. Use a light or some other means to illuminate the subject. 4) Shooting movies for long periods in areas where temperature is relatively high can cause digital noise (dots of light) to appear in the movie image. If this happens, move to a cooler environment or turn off the camera and allow it to cool down, which should cause normal operation to resume.

Problem	Possible Cause and Recommended Action
A recorded image was not saved.	1) Camera power may have been turned off before the save operation was complete, which will result in the image not being saved. If the battery indicator shows  , charge the battery as soon as possible (page 21). 2) You may have removed the memory card from the camera before the save operation was complete, which will result in the image not being saved. Do not remove the memory card before the save operation is complete.
Though available lighting is bright, the faces of people in the image are dark.	Not enough light is reaching the subjects. Change the flash mode setting to  (Flash On) for daylight synchro flash (page 48), or adjust EV shift to the + side (page 47).
Night shots come out bad.	Use the following BEST SHOT scenes (page 74) when shooting at night. <ul style="list-style-type: none"> • High Speed Night Scene (for shooting night scenery only) • High Speed Night Scene and Portrait (for shooting people against night scenery)
Subjects are too dark when shooting images in a seashore or ski area.	Sunlight reflected by water, sand, or snow, can cause underexposure of images. Change the flash mode setting to  (Flash On) for daylight synchro flash (page 48), or adjust EV shift to the + side (page 47).
Digital zoom will not go up to the maximum value.	1) The digital zoom setting may be turned off. Turn on digital zoom (page 103). 2) Zoom will not go up to the maximum value if the “Zoom (SR)” setting is “Single”. Change the setting to “Off” (page 54). 3) Zoom will not go up to the maximum value if the snapshot size setting is “VGA”. Change to a different setting (page 94).
The image is out of focus during movie recording.	1) Focusing may not be possible because the subject is outside the focus range. Shoot within the allowable range. 2) The lens may be dirty. Clean the lens (page 174). 3) During High Speed Movie recording, focus is fixed at the position where it was when recording started. To focus an image, half-press the shutter button for Auto Focus or focus manually before you press  (Movie) to start recording.
Movie recording suddenly stops.	The camera’s protection function may have activated because camera temperature is too high. Wait until the camera temperature drops to normal levels.

Problem	Possible Cause and Recommended Action
Playback	
The color of the playback image is different from what appears on the monitor screen when shooting.	Sunlight or light from another source may be shining directly into the lens when you are shooting. Position the camera so sunlight does not shine directly into the lens.
Images are not displayed.	This camera cannot display non-DCF images recorded onto a memory card using another digital camera.
Images cannot be edited (with White Balance, Brightness, Resize, Trimming, Rotation).	<p>Note that you cannot edit the following types of snapshots.</p> <ul style="list-style-type: none"> • Snapshots created using MOTION PRINT • CS group snapshots • Movies • Panorama Image • Snapshots recorded with another camera
File Deletion	
A file cannot be deleted.	<ol style="list-style-type: none"> 1)The file may be protected. Unprotect the file (page 127). 2)"Delete Key" setting may be "Disabled". Change the setting to "Enabled" (page 160).
Other	
The wrong date and time are displayed, or the wrong date and time are being stored along with image data.	The date and time setting is off. Set the correct date and time (page 162).
The messages on the display are in the wrong language.	The wrong display language is selected. Change the display language setting (page 163).
Images cannot be transferred over a USB connection.	<ol style="list-style-type: none"> 1)The USB cable may not be connected securely. Check all connections. 2)The wrong USB communication protocol is selected. Select the correct USB communication protocol in accordance with the type of device you are connecting (pages 142, 145). 3)If the camera is not turned on, turn it on. 4)Your computer may not be able to recognize the camera if you connect via a USB hub. Always connect directly to the computer's USB port.

Problem	Possible Cause and Recommended Action
Language selection screen appears when the camera is turned on.	<p>1) You did not configure initial settings after purchasing the camera or the camera may have been left with a dead battery. Configure the correct settings (pages 22, 163).</p> <p>2) There may be a problem with the camera's memory data. If this is the case, perform the reset operation to initialize the camera's setup (page 165). After that, configure each setting. If the language selection screen does not re-appear when you turn the camera on, it means that the camera's memory management data has been restored.</p> <p>If the same message appears after you turn power back on, contact your retailer or a CASIO authorized service center.</p>
There are various indicators and values on the monitor screen.	The monitor screen shows indicators and other information about shooting conditions and the image you are recording. You can use [▲] (DISP) to select what information you want to include on the display (page 10).
The time and date settings configured the first time after purchasing the camera are reset to their factory defaults when I remove the camera's battery.	<p>Load the camera's battery and reconfigure the time and date settings (page 22). Do not remove the battery from the camera for at least 24 hours after configuring time and date settings. After that, the settings will not be reset if you remove the battery.</p> <ul style="list-style-type: none"> • If the time and date are reset to their factory default settings when you remove the battery after it has been loaded for more than 24 hours, it could mean that the camera's setting memory is defective. Contact your retailer or a CASIO authorized service center.
Buttons are not responsive right after the power has been turned on.	With large capacity memory cards there is a delay after the power has been turned on before the buttons become responsive.

Display Messages

ALERT	The camera's protection function may have activated because camera temperature is too high. Turn off the camera and wait until it cools down before trying to use it again.
Battery is low.	Battery power is low.
Can not find the file.	The image you specified with the slideshow "Images" setting cannot be found. Change the "Images" setting (page 121) and try again.
Card ERROR	<p>There is something wrong with the memory card. Turn off the camera, remove the memory card and then reload it into the camera. If this message re-appears when you turn the camera back on, format the memory card (page 165).</p> <p> IMPORTANT!</p> <ul style="list-style-type: none">• Formatting a memory card deletes all its files. Before formatting, try transferring recoverable files to a computer or some other storage device.
Check connections!	You are attempting to connect the camera to a printer while the camera's USB settings are not compatible with the USB system of the printer (page 133).
Connecting to the network	Camera power was turned off while image data was being copied to a computer or other device using a FlashAir card or an Eye-Fi card (pages 148, 150).
File could not be saved because battery is low.	Battery power is low, so an image file could not be saved.
Folder cannot be created.	You are trying to record a file while there are already 9999 files stored in the 999th folder. If you want to record more, delete files you no longer need (page 33).
LENS ERROR	This message appears and the camera turns off whenever the lens performs some unexpected operation. If the same message appears after you turn power back on, contact a CASIO authorized service center or your original retailer.
LENS ERROR 2	The Anti Shake unit of the camera may be malfunctioning. If the same message appears after you turn power back on, contact your retailer or a CASIO authorized service center.
Load paper!	The printer ran out of paper while printing.

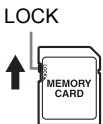
Memory Full	Memory is full with images you recorded and/or files saved by editing operations. When shooting with Prerecord CS, this message indicates that there is not enough memory capacity to record all of the pre-recorded images. Delete files you no longer need (page 33).
Printing Error	An error occurred while printing. <ul style="list-style-type: none"> • The printer is turned off. • The printer generated an error, etc.
Record Error	Image compression could not be performed for some reason during image data recording. Perform a zoom operation to change the composition of the image and shoot it again.
SYSTEM ERROR	Your camera system is corrupted. Contact your retailer or a CASIO authorized service center.
The card is locked.	The LOCK switch of the SD, SDHC, or SDXC memory card loaded in the camera is in the locked position. You cannot store images to or delete images from a memory card that is locked. 
There are no files.	There are no files in built-in memory or on the memory card.
There are no printing images. Set up DPOF.	There are currently no files specified for printing. Configure the required DPOF settings (page 135).
There is no image to register.	The setup you are trying to save is for an image that cannot be saved as a user "CUSTOM SHOT" scene.
This card is not formatted.	The memory card loaded in the camera is not formatted. Format the memory card (page 165).
This file cannot be played.	The file you are trying to access is corrupted or is a type that cannot be displayed by this camera.
This function cannot be used.	This message will appear part way through an operation when you attempt to use a function that is not allowed in combination with another function.

Number of Snapshots/Movie Recording Time

Snapshot

Image Size (Pixels)	Quality	File Size	Built-in Memory* ¹ Recording Capacity	SD Memory Card* ² Recording Capacity
16M (4608×3456)	Fine	10.71 MB	3	1072
	Normal	5.57 MB	5	1654
3:2 (4608×3072)	Fine	9.43 MB	4	1214
	Normal	4.92 MB	6	1873
16:9 (4608×2592)	Fine	7.83 MB	5	1466
	Normal	4.1 MB	7	2221
10M (3648×2736)	Fine	6.4 MB	6	1787
	Normal	3.38 MB	9	2728
5M (2560×1920)	Fine	2.99 MB	10	2990
	Normal	1.72 MB	14	4283
3M (2048×1536)	Fine	2.0 MB	15	4669
	Normal	1.25 MB	22	6533
VGA (640×480)	Fine	430 KB	67	19683
	Normal	290 KB	91	26809

Movies

Image Size/Pixels (Audio)	Approximate Data Rate (Frame Rate)	Maximum File Size	Built-in Memory* ¹ Recording Capacity	Maximum Recording Time with SD Memory Card* ²	File Size of 1-minute Movie	Continuous Recording Time per Movie* ³
FHD (1920×1080) (Stereo)	14.2 Megabits/second (30 frames/second)	4GB or 29 minutes	27 seconds	2 hours 13 minutes	106.5 MB	29 minutes
HD (1280×720) (Stereo) * ⁵	10.9 Megabits/second (15, 20, 30 frames/second)		35 seconds	2 hours 53 minutes	81.8 MB	29 minutes
STD (640×480) (Stereo)	3.9 Megabits/second (30 frames/second)		1 minute 41 seconds	8 hours 12 minutes	29.3 MB	29 minutes
HS1000 (224×64) (No audio)	40.0 Megabits/second (1000 frames/second)		10 seconds	48 minutes	300.0 MB	13 minutes 10 seconds
HS480 (224×160) (No audio)	40.0 Megabits/second (480 frames/second)		9 seconds	48 minutes	300.0 MB	13 minutes 2 seconds
HS240 (512×384) (No audio)	40.0 Megabits/second (240 frames/second)		9 seconds	48 minutes	300.0 MB	12 minutes 58 seconds
HS120 (640×480) (No audio)	40.0 Megabits/second (120 frames/second)		9 seconds	47 minutes	300.0 MB	12 minutes 55 seconds
HS30-240 (512×384) (Audio recording at 30 fps only)	5.4 Megabits/second (30 frames/second) 40.4 Megabits/second (240 frames/second)		1 minute 13 seconds * ⁴	5 hours 59 minutes * ⁴	40.5 MB * ⁴	29 minutes * ⁴
HS30-120 (640×480) (Audio recording at 30 fps only)	10.4 Megabits/second (30 frames/second) 40.4 Megabits/second (120 frames/second)		38 seconds * ⁴	3 hours 5 minutes * ⁴	78.0 MB * ⁴	29 minutes * ⁴

Image Quality (Pixels) / (Audio)	Approximate Data Rate (Frame Rate)	Maximum File Size	Built-in Memory* ¹ Recording Capacity	Maximum Recording Time with SD Memory Card* ²	Continuous Recording Time per Movie* ³
YouTube (FHD) (1920×1080) (Stereo)	14.2 Megabits/second (30 frames/second)	2048MB or up to a maximum playback time of 15 minutes	27 seconds	2 hours 13 minutes	15 minutes
YouTube (STD) (640×480) (Stereo)	3.9 Megabits/second (30 frames/second)		1 minute 41 seconds	8 hours 12 minutes	15 minutes
YouTube (HS1000) (224×64) (No audio)	40.0 Megabits/second (1000 frames/second)		10 seconds	48 minutes	27 seconds
YouTube (HS480) (224×160) (No audio)	40.0 Megabits/second (480 frames/second)		9 seconds	48 minutes	56 seconds
YouTube (HS240) (512×384) (No audio)	40.0 Megabits/second (240 frames/second)		9 seconds	48 minutes	1 minute 52 seconds
YouTube (HS120) (640×480) (No audio)	40.0 Megabits/second (120 frames/second)		9 seconds	47 minutes	3 minutes 45 seconds
YouTube (HS30-240) (512×384) (Audio recording at 30 fps only)	5.4 Megabits/second (30 frames/second) 40.4 Megabits/second (240 frames/second)		1 minute 13 seconds ^{*4}	5 hours 59 minutes ^{*4}	15 minutes ^{*4}
YouTube (HS30-120) (640×480) (Audio recording at 30 fps only)	10.4 Megabits/second (30 frames/second) 40.4 Megabits/second (120 frames/second)		38 seconds ^{*4}	3 hours 5 minutes ^{*4}	15 minutes ^{*4}

*1 Built-in memory capacity after formatting (Approx. 52.2MB)

*2 When using a 16GB SDHC memory card (SanDisk Corporation). Number of image and recording time values depend on the memory card you are using.

*3 The allowable recording time will be shorter if the capacity of the SD memory card you are using is smaller than the maximum size of one file.

*4 Recordable time when the entire movie is recorded at 30 fps. Recording time is shorter if the 30 fps frame rate is switched to 120 fps or 240 fps during recording.

*5 "HD" appears in place of "FHD" when you are shooting with "ART SHOT" (page 61).

- Snapshot and movie recording capacity values are approximate and intended for reference only. Actual capacity depends on image contents.
 - File size and data rate values are approximate and intended for reference only. Actual values depend on the type of image being shot.
 - When using a memory card with a different capacity, calculate the number of images as a percentage of 16GB.
 - The time it takes to play back a high speed movie will be different from the time it takes to record it. If you record a 240 fps high speed movie for 10 seconds, for example, it will take 80 seconds to play it back.
-

Specifications

File Format	Snapshots: JPEG (Exif Version 2.3; DCF 2.0 standard; DPOF compliant) Movies: MOV format, H.264/AVC standard, IMA-ADPCM (stereo)
Recording Media	Built-in Memory (Image Storage Area: 52.2MB*) SD/SDHC/SDXC * Built-in memory capacity after formatting
Recorded Image Sizes	Snapshots: 16M (4608×3456), 3:2 (4608×3072), 16:9 (4608×2592), 10M (3648×2736), 5M (2560×1920), 3M (2048×1536), VGA (640×480) Movies: FHD (1920×1080 30 fps), HD (1280×720 15 fps/20 fps/ 30 fps) (When shooting movie with ART SHOT only.), STD (640×480 30 fps), HS1000 (224×64 1000 fps), HS480 (224×160 480 fps), HS240 (512×384 240 fps), HS120 (640×480 120 fps), HS30-240 (512×384 30-240 fps switchable), HS30-120 (640×480 30-120 fps switchable)
Effective Pixels	16.1 Megapixels
Imaging Element	Size: 1/2.3-inch square pixel high-speed CMOS Total Pixels: 16.79 Megapixels
Lens/Focal Distance (Snapshot)	F3.0 (W) to 5.9 (T) f = 4.24 to 53.0 mm (equivalent to 24 to 300 mm in 35 mm format)
Zoom	12.5X Optical zoom, 25.0X in combination with Multi SR Zoom 4X Digital zoom Up to 199.3X when HD Zoom and Digital zoom are used in combination (VGA size)
Focusing	Contrast Detection Auto Focus; with AF assist light • Focus Modes: Auto Focus, Macro Focus, Super Macro Focus, Infinity, Manual Focus • AF Area: Intelligent, Spot, Multi, Tracking
Approximate Focus Range (From Lens Surface)	Auto Focus: 5 cm to ∞ (2.0" to ∞) (Wide Angle) Macro Focus: 1 cm to 50 cm (0.4" to 19.7") (Fifth step zoom from the Widest Angle setting) Super Macro Focus: 1 cm to 50 cm (0.4" to 19.7") Infinity: ∞ (Wide Angle) Manual Focus: 5 cm to ∞ (2.0" to ∞) (Wide Angle) • Range is affected by optical zoom.
Metering	Multi-pattern, center weighted, and spot by imaging element
Exposure Control	Program AE, Aperture Priority AE, Shutter Speed Priority AE, Manual Exposure
Exposure Compensation	-2.0 EV to +2.0 EV (in 1/3EV steps)

Shutter	CMOS electronic shutter, mechanical shutter
Shutter Speed	Snapshot (Program Auto): 1/4 to 1/2000 second Snapshot (Premium Auto PRO): 4 to 1/4000 second Snapshot (Aperture Priority AE): 1 to 1/2000 second Snapshot (Shutter Speed Priority AE): 15 to 1/2000 second Snapshot (Manual Exposure): 15 to 1/2000 second <ul style="list-style-type: none"> • 1/25000-second shutter speed is possible only with High speed Continuous Shutter, shutter speed priority AE or manual exposure. • May differ due to the camera setup.
Aperture Value	F3.0 (W) to F7.9 (W) (With ND filter) <ul style="list-style-type: none"> • Using optical zoom changes the aperture value.
White Balance	Auto, Daylight, Overcast, Shade, Day White Fluorescent, Daylight Fluorescent, Tungsten, Manual WB
Sensitivity (Standard Output Sensitivity)	Snapshots: Auto, ISO 80, ISO 100, ISO 200, ISO 400, ISO 800, ISO 1600, ISO 3200 equivalent Snapshots (High Speed Night Shot): ISO 25600 equivalent maximum Movies: Auto
Flash Modes	Auto, Off, On, Red-eye reduction
Flash Range (ISO Sensitivity: Auto)	0.4 m to 4.7 m (1.3' to 15.4') (Wide Angle) 0.9 m to 2.4 m (3.0' to 7.9') (Telephoto) <ul style="list-style-type: none"> • Range is affected by optical zoom.
Flash Intensity Adjustment	-2, -1, 0, +1, +2
Flash Charging Time	Approximately 5 seconds
Monitor Screen	3.0-inch TFT color LCD (Super Clear LCD) 460,800 (960×480) dots
External connection terminal	USB port (Hi-Speed USB compliance, USB charging), AV output terminal (NTSC/PAL) HDMI output (Mini)
Microphones	Stereo
Speaker	Monaural
Power Requirements	Rechargeable lithium ion battery (NP-130) ×1

Approximate Battery Life

All of the values provided below represent the approximate amount of time under normal temperature (23°C (73°F)) before the camera turns off. These values are not guaranteed. Low temperatures shorten battery life.

Number of Shots (Operating Time)*¹	515 shots
Number of Shots (ECO)*¹	640 shots
Actual movie recording time (FHD Movie)*¹	1 hour 35 minutes
Approximate continuous movie recording time (FHD Movie)	2 hours 35 minutes
Approximate continuous movie recording time (High speed movie (HS 240))	2 hours 55 minutes
Continuous Playback (Snapshots)*²	5 hours 50 minutes

- Battery: NP-130 (Rated Capacity: 1800 mAh)
- Recording Medium: 16GB SDHC memory card (SanDisk Corporation)

*¹ In accordance with CIPA (Camera and Imaging Products Association) standards

*² Standard temperature (23°C (73°F)), one-image scroll approximately every 10 seconds

- The above values are based a new battery, starting from a full charge. Repeated charging shortens battery life.
- Frequency of flash, zoom, High Speed Continuous Shutter, and Auto Focus usage, and the time the camera is on greatly affects recording time and number of shots values.

Power Consumption	3.7 V DC, Approximately 5.6 W
Dimensions	104.8 (W) × 59.1 (H) × 28.6 (D) mm (4.1" (W) × 2.3" (H) × 1.1" (D)) (24.2 mm (0.95") thick excluding projections)
Weight	Approximately 205 g (7.2 oz) (including battery and memory card*) Approximately 165 g (5.8 oz) (excluding battery and memory card) * 16GB SDHC memory card (SanDisk Corporation)

■ Rechargeable lithium ion battery (NP-130)

Rated Voltage	3.7 V
Rated Capacitance	1800 mAh
Operating Temperature Requirements	0 to 40°C (32 to 104°F)
Dimensions	37.8 (W) × 44.8 (H) × 11.2 (D) mm (1.49" (W) × 1.76" (H) × 0.44" (D)) (excluding projections)
Weight	Approximately 38 g (1.3 oz)

■ USB-AC adaptor (AD-C53U)

Input Power	100 to 240 V AC, 50/60 Hz, 100 mA
Output Power	5.0 V DC, 650 mA
Operating Temperature Requirements	5 to 35°C (41 to 95°F)
Dimensions	53 (W) × 21 (H) × 45 (D) mm (2.1" (W) × 0.83" (H) × 1.8" (D)) (excluding projections)
Weight	Approximately 37 g (1.3 oz)

- Power cord precautions for use in Singapore
The power cord set is not supplied. The power cord used must comply with relevant national and/or international standards.

Declaration of Conformity According to EU Directive



Manufacturer:
CASIO COMPUTER CO., LTD.
6-2, Hon-machi 1-chome, Shibuya-ku, Tokyo 151-8543, Japan

Responsible within the European Union:
CASIO EUROPE GmbH
Casio-Platz 1, 22848 Norderstedt, Germany

CASIO®

CASIO COMPUTER CO., LTD.
6-2, Hon-machi 1-chome
Shibuya-ku, Tokyo 151-8543, Japan