

# USING A MEMORY CARD

You can expand the storage capabilities of your camera by using a commercially available memory card (SD memory card or MultiMedia Card). You can also copy files from built-in flash memory to a memory card and from a memory card to flash memory.



- Normally, files are stored in built-in flash memory. When you insert a memory card, however, the camera automatically stores files to the card.
- Note that you cannot save files to built-in memory while a memory card is installed in the camera.

## ▶▶ IMPORTANT! ◀◀

- Make sure you turn off the camera before inserting or removing a memory card.
- Be sure to orient the card correctly when inserting it. Never try to force a memory card into the slot when you feel resistance.
- See the instructions that come with the memory card for information about how to use it.
- Certain types of cards can slow down processing speeds.
- SD memory cards have a write protect switch, which you can use to protect against accidental deletion of image data. Note, however, if you write protect an SD memory card, you must remove write protection whenever you want to record to it, format it, or delete any of its files.

## Using a Memory Card

### To insert a memory card into the camera

1. While pressing the battery cover on the bottom of the camera, slide the cover in the direction indicated by the arrow, and then swing it open.
2. Positioning the memory card so its front is facing in the same direction as the camera's monitor screen, carefully slide it into the card slot.

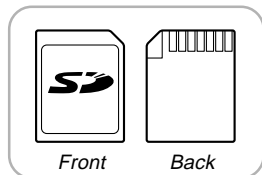
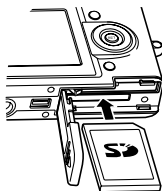
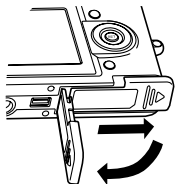

3. Swing the battery cover closed, and then slide it in the direction indicated by the arrow.

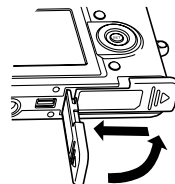

### To remove a memory card from the camera

1. Press the memory card into the camera and then release it. This will cause the card to come part way out of the camera.
2. Pull the memory card out of the slot.

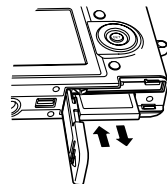

### ▶▶ IMPORTANT! ◀◀

- Never insert any other object besides a memory card into the camera's card slot. Doing so creates the risk of damage to the camera and card.
- Should water or any foreign object ever get into the card slot, immediately turn off the camera, remove the battery, and contact your dealer or nearest CASIO authorized service center.
- Never remove a card from the camera while the operation lamp is flashing. Doing so can cause the file save operation to fail, and even damage the memory card.

## Formatting a Memory Card

Formatting a memory card deletes any data already stored on it.

### ▶▶ IMPORTANT! ◀◀

- Be sure to use the camera to format a memory card. Formatting a memory card on a computer and then using it in the camera can slow down data processing by the camera. In the case of an SD card, formatting on a computer can result in non-conformity with the SD format, causing problems with compatibility, operation, etc.
- Note that data deleted by a memory card format operation cannot be recovered. Check to make sure you do not need any of the data on the memory card before you format it.
- Formatting a memory card that contains files deletes all the files, even those that are protected (page 97).

1. Load the memory card into the camera.
2. Turn on the camera. Next, enter the REC mode or PLAY mode and press [MENU].
3. Select the “Set Up” tab, select “Format”, and then press [▶].
4. Use [▲] and [▼] to select “Format”, and then press [SET].
  - To exit the format operation without formatting, select “Cancel”.

## Memory Card Precautions

- Use only an SD memory card or a MultiMediaCard with this camera. Proper operation is not guaranteed when any other type of card is used.
- Electrostatic charge, electrical noise, and other phenomena can cause data to become corrupted or even lost. Always make sure that you always back up important data on other media (MO disc, computer hard disk, etc.).
- If a memory card starts to behave abnormally, you can restore normal operation by reformatting it. However, we recommend that you always take along more than one memory card whenever using the camera far away from the home or office.
- We recommend that you format a memory card before using it for the first time after purchasing it, or whenever the card you are using seems to be the cause of abnormal images.
- Before starting a format operation, check to make sure that the battery is fully charged. Power interruption during the format operation can result in improper formatting, and even damage the memory card and make it unusable.

### Copying Files

Use the procedures below to copy files between built-in memory and a memory card.

#### ▶▶ IMPORTANT! ◀◀

- Only snapshot and movie files recorded with this camera can be copied. Other files cannot be copied.

### To copy all the files in built-in memory to a memory card

1. Load the memory card into the camera.
2. Turn on the camera. Next, enter the PLAY mode and press [MENU].
3. Select the “PLAY” tab, select “Copy”, and then press [▶].



4. Use [▲] and [▼] to select “Built-in → Card”, and then press [SET].

- This starts the copy operation and displays the message “Busy... Please wait..”.
- After the copy operation is complete, the monitor screen shows the last file in the folder.

## To copy a file from a memory card to built-in memory

With this procedure you can copy one file at a time.

1. Perform steps 1 through 3 of the procedure under “To copy all the files in built-in memory to a memory card”.
2. Use [▲] and [▼] to select “Card → Built-in”, and then press [SET].
3. Use [◀] and [▶] to select the file you want to copy.
4. Use [▲] and [▼] to select “Copy”, and then press [SET].
  - This starts the copy operation and displays the message “Busy... Please wait..”.
  - The file reappears on the monitor screen after the copy operation is complete.
  - Repeat steps 3 through 4 to copy other images, if you want.
5. Press [MENU] to exit the copy operation.

### NOTE

- Files are copied to the folder in built-in memory whose name has the largest number.

# VIEWING IMAGES ON A COMPUTER

After using the USB cradle to establish a USB connection between the camera and your computer, you can use your computer to view images in file memory and copy images to your computer's hard disk or other storage media. In order to do this, you first need to install the USB driver located on the CD-ROM that comes bundled with the camera onto your computer.

Note that the procedure you need to perform depends on whether you are using computer running under Windows (see below) or a Macintosh (see page 129).

## Using the Camera with a Windows Computer

The following are the general steps for viewing and copying files from a computer running under Windows. You can find details about each operation in the procedures that follow below. Note that you should also refer to the documentation that comes with your computer for other information about USB connections, etc.

1. If you are running Windows 98, Me, or 2000, install the USB driver onto your computer.
  - You need to perform this step only once, the first time you connect to your computer.
  - If you are running Windows XP, you do not need to install the USB driver.



2. Use the USB cradle to establish a connection between the camera and computer.



3. View and copy the images you want.

## VIEWING IMAGES ON A COMPUTER

### »» IMPORTANT! ««

- Do not try to establish a connection between the camera and computer before installing the USB driver onto the computer.
- If you want to transfer files from the camera's built-in memory to a computer, make sure there is no memory card loaded in the camera before you place it onto the USB cradle.

### 1. What you should do first depends on whether your computer is running under Windows 98/Me/2000 or Windows XP.

#### ■ Windows 98/Me/2000 Users

- Start from step 2 to install the USB driver.
- Note that the example installation presented here uses Windows 98.

#### ■ Windows XP Users

- Installation of the USB driver is not required, so jump directly to step 6.

### 2. Set the bundled CD-ROM into the CD-ROM drive of your computer.

### 3. On the menu screen that appears, click the language button in the upper left corner of the display, and then select a language from the list that appears.



### 4. Click [USB driver] and then [Install].

- This starts installation.
- The following steps show installation under the English version of Windows.

### 5. On the screen that appears after installation is complete, select the “Yes, I want to restart my computer now.” check box and then click [Finish] to restart your computer.



## VIEWING IMAGES ON A COMPUTER

### 6. Connect the bundled AC adaptor to the [DC IN 5.3V] connector of the USB cradle, and then plug it in to a household power outlet.

- Note that the shape of the AC adaptor depends on the area where you purchased the camera.

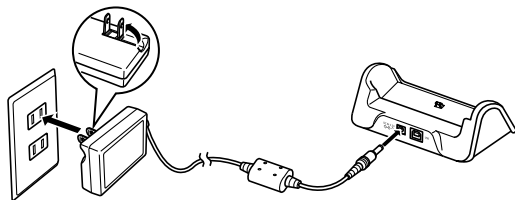
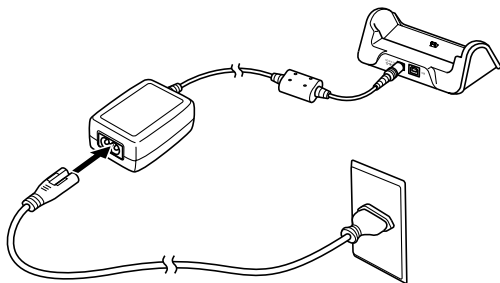

### 7. Connect the USB cable that comes bundled with the camera to the USB cradle and your computer's USB port.

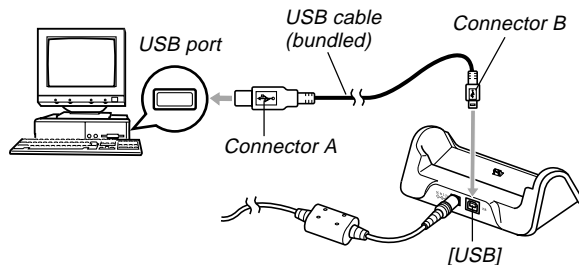

- Take care when connecting the USB cable to the USB cradle or your computer. USB ports and cable plugs are shaped for proper positioning.
- Plug the USB cable plugs into the ports securely, as far as they will go. Proper operation is not possible if connections are not correct.

### 8. After making sure the camera is turned off, place the camera onto the USB cradle.

- Do not place the camera onto the USB cradle while it is turned on.

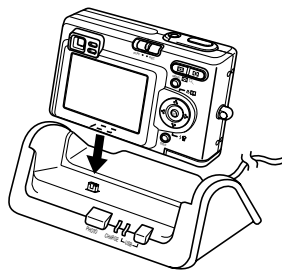

### 9. Press the USB cradle's [USB] button.

- This will cause the "New Hardware..." dialog box to appear on the computer screen as the computer automatically detects the camera's file memory. After you install the USB driver, "New Hardware..." dialog box will no longer appear when you perform the above steps to establish a USB connection.
- Pressing the [USB] button enters the USB mode, which causes the USB cradle's [USB] lamp to light green (page 158).
- At this point, some operating systems will display a "Removable Disk" dialog box. If your operating system does, close the dialog box.

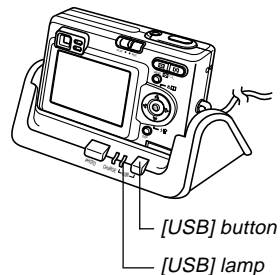

- 10. On your computer, double-click “My Computer”.**
  - 11. Double-click “Removable Disk”.**
    - Your computer sees the camera’s file memory as a removable disk.
  - 12. Double-click the “Dcim” folder.**
  - 13. Double-click the folder that contains the image you want.**
  - 14. Double-click the file that contains the image you want to view.**
    - For information about file names, see “Memory Directory Structure” on page 136.
  - 15. To copy all the files in file memory to your computer’s hard disk, drag the “Dcim” folder from “Removable Disk” to the “My Documents” folder on your computer.**
- 
- 16. Depending on the version of Windows you are running, use one of the following procedures to terminate the USB connection.**
    - WindowsMe/98 Users**
      - After pressing the USB cradle [USB] button and making sure that the [USB] lamp is not lit, remove the camera from the USB cradle.
    - Windows2000/XP Users**
      - Click card services in the task tray on your computer screen, and disable the drive number assigned to the camera. After pressing the USB cradle [USB] button and making sure that the [USB] lamp is not lit, remove the camera from the USB cradle.

### USB Connection Precautions

- Be sure to read the documentation that comes with your computer for other important information about USB connections.
- Be sure to connect the AC adaptor to the USB cradle to supply power to the camera.
- USB data communication is performed regardless of the current setting of the camera's mode selector.
- Do not leave the same image displayed on your computer screen for a long time. Doing so can cause the image to "burn in" on the screen.
- Never disconnect the USB cable, or perform any camera or USB cradle operation while data communication is in progress. Doing so can cause data to become corrupted.

### Using the Camera with a Macintosh Computer

The following are the general steps for viewing and copying files from a Macintosh.

You can find details about each operation in the procedures that follow below. Note that you should also refer to the documentation that comes with your Macintosh for other information about USB connections, etc.

#### ▶▶ IMPORTANT! ◀◀

- This camera does not support operation with a computer running Mac OS 8.5.1 or lower, or Mac OS X 10.0.

1. If your operating system is anything other than Mac OS 9 or Mac OS X, install the USB driver onto your Macintosh.
  - You need to perform this step only once, the first time you connect to your computer. If you are running Mac OS 9 or Mac OS X, you do not need to install the USB driver.
2. Use the USB cradle to establish a connection between the camera and your Macintosh.
3. View and copy the images you want.

### ►► IMPORTANT! ◀◀

- If you want to transfer files from the camera's built-in memory to a computer, make sure there is no memory card loaded in the camera before you place it onto the USB cradle.

### 1. What you should do first depends on whether your Macintosh is running under Mac OS 8.6 or Mac OS 9/OS X.

#### ■ Mac OS 8.6 Users

- Start from step 2 to install the USB driver.
- Note that the example installation presented here uses Mac OS 8.6.

#### ■ Mac OS 9/OS X Users

- Installation of the USB driver is not required, so jump directly to step 9.
- The following steps show installation under the English OS.

### 2. Set the bundled CD-ROM into the Macintosh CD-ROM drive.

### 3. Double-click the hard disk that is specified as your startup disk.

## VIEWING IMAGES ON A COMPUTER

4. On the “Hard Disk” window that opens, double-click the “System Folder” to open it.
5. On the “System Folder” window, double-click the “Extensions” folder to open it.
6. Double-click the “CASIO” folder and then the “ENGLISH” folder. Next, double-click the CD-ROM’s “USB Driver” folder to open it.
7. On the “USB Driver” window that opens, drag the “CASIO - USB StorageDriver” file and “CASIO-USB StorageClassShim” file to the “Extensions” folder window you opened above.
8. This completes USB driver installation. After checking the “Extensions” folder to make sure that it contains the “CASIO-USB StorageDriver” and “CASIO-USB StorageClassShim” files, restart your Macintosh.

9. Connect the bundled AC adaptor to the [DC IN 5.3V] connector of the USB cradle, and then plug it in to a household power outlet.

- Note that the shape of the AC adaptor depends on the area where you purchased the camera.

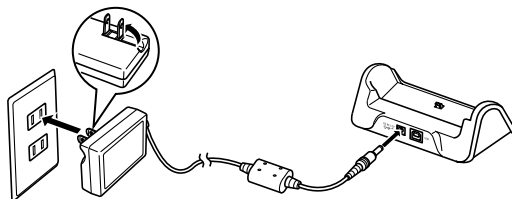
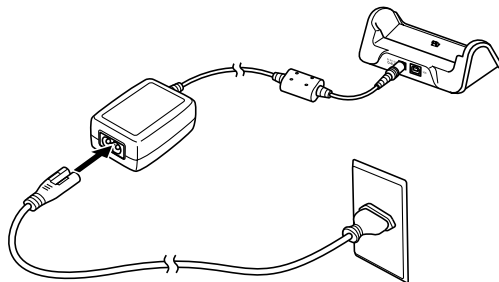

## VIEWING IMAGES ON A COMPUTER

- 10. Connect the USB cable that comes bundled with the camera to the USB cradle and your computer's USB port.**

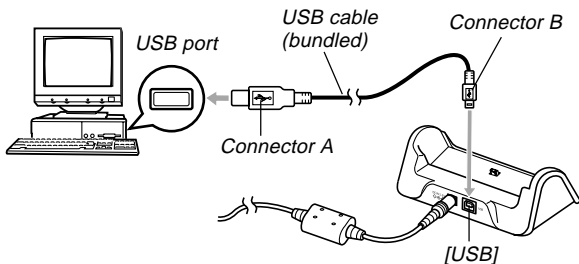

- Take care when connecting the USB cable to the USB cradle or your computer. USB ports and cable plugs are shaped for proper positioning.
- Plug the USB cable plugs into the ports securely, as far as they will go. Proper operation is not possible if connections are not correct.

- 11. After making sure the camera is turned off, place the camera onto the USB cradle.**

- Do not place the camera onto the USB cradle while it is turned on.

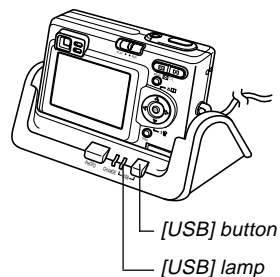

### **12. Press the USB cradle's [USB] button.**

- Pressing the [USB] button enters the USB mode, which causes the USB cradle's [USB] lamp to light green (page 158).

### **13. Your Macintosh will see the camera's file memory as a drive.**

- The appearance of the drive icon depends on the Mac OS version you are using.
- After installing the USB driver, your Macintosh will see the camera's file memory as a drive whenever you establish a USB connection between them.

### **14. Double-click the drive icon for the camera's file memory, the "DCIM" folder, and then the folder that contains the image you want.**

### **15. Double-click the file that contains the image you want to view.**

- For information about file names, see "Memory Directory Structure" on page 136.

### **16. To copy all the files in file memory to your Macintosh hard disk, drag the "DCIM" folder to the folder to which you want to copy it.**

### **17. To terminate the USB connection, drag the drive icon that represents the camera to Trash. After pressing the USB cradle [USB] button and making sure that the [USB] lamp is not lit, remove the camera from the USB cradle.**



### USB Connection Precautions

- Be sure to read the documentation that comes with your computer for other important information about USB connections.
- Be sure to connect the AC adaptor to the USB cradle to supply power to the camera.
- USB data communication is performed regardless of the current setting of the camera's mode selector.
- Do not leave the same image displayed on your computer screen for a long time. Doing so can cause the image to "burn in" on the screen.
- Never disconnect the USB cable, or perform any camera or USB cradle operation while data communication is in progress. Doing so can cause data to become corrupted.

### Operations You Can Perform from Your Computer

The following are the operations you can perform while there is a USB connection between your camera and computer. See the referenced pages for more information about each operation.

- View images in album format  
.... See "Using the Album Feature" on page 139.
- Print images in album format  
.... See "Using the Album Feature" on page 139.
- Automatically transfer images to your computer and manage images  
.... See "Installing the Software from the CD-ROM" on page 146 for information about installing Photo Loader.
- Retouch images  
.... See "Installing the Software from the CD-ROM" on page 146 for information about installing Photohands.

### Using a Memory Card to Transfer Images to a Computer

The procedures in this section describe how to transfer images from the camera to your computer using a memory card.

#### Using a Computer with a Built-in SD Memory Card Slot

Insert the SD memory card directly into the slot.

#### Using a Computer with a Built-in PC Card Slot

Use a commercially available PC card adapter (for an SD memory card/MMC). For full details, see the user documentation that comes with the PC card adapter and your computer.

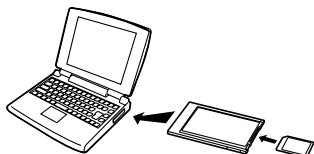

#### Using a Commercially Available SD Memory Card Reader/Writer

See the user documentation that comes with the SD memory card reader/writer for details about how to use it.

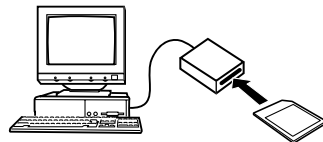

#### Using a Commercially Available PC Card Reader/Writer and PC Card Adapter (for SD Memory Cards and MMCs)

See the user documentation that comes with the PC card reader/writer and PC card adapter (for an SD memory card/MMC) for details about how to use them.

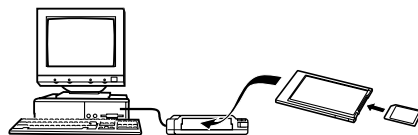

## Memory Data

Images recorded with this camera and other data are stored in memory using DCF (Design rule for Camera File System) protocol. DCF protocol is designed to make it easier to exchange image and other data between digital cameras and other devices.

## DCF Protocol

DCF devices (digital cameras, printers, etc.) can exchange images with each other. DCF protocol defines camera format for image file data and the directory structure for file memory, so images can be viewed using another manufacturer's DCF camera or printed on a DCF printer.

## Memory Directory Structure

### ■ Directory Structure

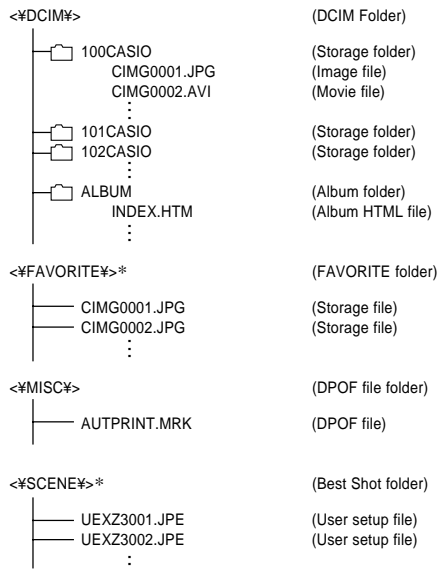

\* These folders are created in built-in memory only.

### ■ Folder and File Contents

- **DCIM folder**  
Folder that stores all of the digital camera files
- **Storage folder**  
Folder for storing files created by the digital camera
- **Image file**  
File that contains an image recorded with the digital camera (File Name Extension: JPG)
- **Movie file**  
File that contains a movie recorded with the digital camera (File Name Extension: AVI)
- **Album folder**  
Folder that contains files used by the album function
- **Album HTML file**  
File used by the album function  
(File Name Extension: HTM)
- **FAVORITE folder**  
Folder that contains Favorites image files  
(Image Size: 320 x 240 pixels)
- **DPOF file folder**  
Folder that contains DPOF files
- **Best Shot folder (Built-in memory only)**  
Folder that contains Best Shot user setup files.
- **User setup files (Built-in memory only)**  
Files that contain Best Shot user setups

### Image Files Supported by the Camera

- Image files recorded with the CASIO EX-Z3 Digital Camera
- DCF protocol image files

Certain DCF functions may not be supported. When displaying an image recorded on another camera model, it may take a long time for the image to appear on the display.

## Built-in Memory and Memory Card Precautions

- Note that the folder named “DCIM” is the parent (top) folder of all the files in memory. When transferring memory contents to a hard disk, CD-R, MO disk, or other external storage, treat all the contents inside a DCIM folder as a set and always keep them together. You can change the name of the DCIM folder on your computer. Changing the name to a date is a good way to keep track of multiple DCIM folders. However, if you even want to copy the folders back to the camera’s file memory, be sure you change the name of the DCIM folder back to “DCIM” first. The camera does not recognize any folder name other than DCIM.
- We also strongly recommend that after transferring data from file memory to other external storage that you reformat the camera’s file memory and delete its contents before using it to store more files. Remember that formatting memory deletes all of its contents. Check to make sure that you no longer need any of the files in memory before you format it.

# USING THE CAMERA WITH A COMPUTER

The album feature of the camera creates files that make it possible for you to view images on your computer in a photo album layout. You can also use the applications contained on the CD-ROM that comes bundled with the camera to automate image transfer and to retouch images.

## Using the Album Feature

The album feature creates an HTML photo album layout that displays your images. You can use the HTML layout to post your images on a Web page, or for printing the images.

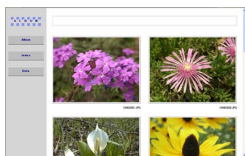

*Album*



*Index*

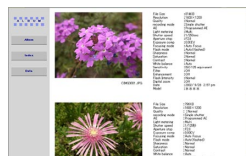

*Info*

- You can use the Web browser shown below to view or print the contents of an album. Note that to view a movie on a computer running Windows 2000 or 98, you need to install DirectX.

Microsoft Internet Explorer Ver 5.5 or later

## Creating an album

1. In the **PLAY** mode, press **[▲]** (📁) (📄).

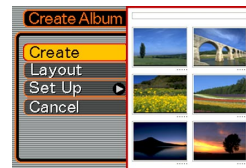

*Sample layout*

2. Use **[▲]** and **[▼]** to select “Create”, and then press **[SET]**.

- This starts creation of the album, and causes the message “Busy.... Please wait..” to appear on the monitor screen.
- The PLAY mode screen reappears after creation of the album is complete.

- Creating an album causes a file folder named “ALBUM”, which contains a file named “INDEX.HTM” plus other files to be created in camera memory or on the memory card.

### ▶▶ IMPORTANT! ◀◀

- Never open the battery cover or remove the memory card from the camera while an album is being created. Doing so not only runs the risk of certain album files being skipped, it can also result in image data and other data in memory being corrupted.
- If memory becomes full while an album is being created, the message “Memory Full” appears on the monitor screen and album creation is terminated.
- Album creation will not be performed properly if the battery goes dead while album creation is in progress.
- You can also configure the camera to create albums automatically (page 142). However, performing the above procedure creates an album regardless of whether automatic album creation is turned on or off.

## Selecting an Album Layout

You can select from among 10 different display layouts for an album.

**1. In the PLAY mode, press [▲] (📖).**

**2. Use [▲] and [▼] to select “Layout”.**

**3. Use [◀] and [▶] to select the layout you want.**

- Changing the layout causes the layout sample on the right side of the screen to change.

### ▶▶ IMPORTANT! ◀◀

- The sample layout shows the arrangement of items and the background color. It does not show whether the layout uses a list view or detailed view, or the current Image Type setting.

## Configuring Detailed Album Settings

1. In the **PLAY** mode, press **[▲]** (📖).
2. Use **[▲]** and **[▼]** to select “Set Up”, and then press **[▶]**.
3. Use **[▲]** and **[▼]** to select the item whose setting you want to change, and then press **[▶]**.
  - Details about each of the settings are provided in the following sections.
4. Use **[▲]** and **[▼]** to change the setting, and then press **[SET]**.



### ■ Background Color

You can specify white, black, or gray as the color of the album background using the procedure under “Configuring Detailed Album Settings”.

### ■ Album Type

There are two album types: “Normal” and “Index/Info”.

“Normal” Type : This type of album displays images in accordance with the currently selected layout.

“Index/Info” Type : In addition to the normal album screen, this type of album also includes thumbnails of images and detailed information about each image.



### ■ Image Use

This setting lets you select from among three different image uses, as described below. Select the image use that best suits the way you plan to use the image.

For this purpose:	Select this setting:
<p>Smaller images for album browsing, Website thumbnails, or archiving on a CD-R or other media, with the full-size image displayed when a thumbnail is clicked</p> <ul style="list-style-type: none"> <li>This setting can be used for browsing with the thumbnails. Clicking a thumbnail displays a larger version for viewing or printing.</li> </ul>	View
<p>Small image files only for album browsing, or uploading to a Website, etc.</p> <ul style="list-style-type: none"> <li>This option displays only the small-file images (located in the camera's "ALBUM" folder). Smaller files upload to the Internet faster.</li> <li>You cannot enlarge images by clicking a thumbnail or play movies while this image is selected.</li> </ul>	WEB
<p>Printing (high resolution)</p> <ul style="list-style-type: none"> <li>High-resolution images take longer to display on your computer screen.</li> <li>You cannot enlarge images by clicking a thumbnail or play movies while this image is selected.</li> </ul>	Print

### ■ Auto Album Creation On/Off

This setting controls whether an album is created automatically whenever you turn off the camera.

To do this:	Select this option:
Turn on auto album creation	On
Turn off auto album creation	Off

- When auto album creation is turned on, an album is created automatically in built-in memory or on the memory card whenever you turn off the camera.

### ▶▶ IMPORTANT! ◀◀

- When you turn off the camera while auto album creation is turned on, the monitor screen turns off, but the operation lamp continues to flash for a few seconds to indicate that the album creation process is being performed. Never open the battery cover or remove the memory card while the green operation lamp is flashing.

### NOTE

- Depending on the number of images in memory, it can take quite a bit of time to complete auto album creation when you turn off the camera. If you do not plan to use the album feature, we suggest that you keep auto album creation turned off, which shortens the amount of time the camera takes to power down completely.

## Viewing Album Files

You can view and print album files using your computer's Web browser application.

1. Use your computer to access the data in built-in memory or on the memory card, or access a memory card with your computer (pages 124 and 136).
2. Open the built-in memory "ALBUM" folder or the memory card "ALBUM" folder, which is located inside the folder named "DCIM".
3. Use your computer's Web browser to open the file named "INDEX.HTM".

- This displays a list of folders in built-in memory or on the memory card.

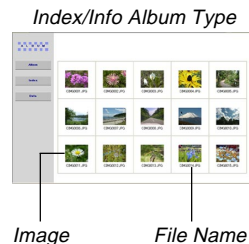



## USING THE CAMERA WITH A COMPUTER

- The following describes the information that appears on the Info Screen.

This Info Screen item:	Shows this:
File Size	Image file size
Resolution	Resolution
Quality	Quality
Drive mode	Drive mode
AE	Exposure mode
Light metering	Metering mode
Shutter speed	Shutter speed
Aperture stop	Aperture stop
Exposure comp	EV shift
Focusing mode	Focusing mode
Flash mode	Flash mode
Sharpness	Sharpness
Saturation	Saturation
Contrast	Contrast
White balance	White balance
Sensitivity	Sensitivity
Filter	Filter setting
Enhancement	Enhancement setting
Flash intensity	Flash intensity
Digital zoom	Digital zoom setting
World	Location
Date	Recording date and time
Model	Camera model name

### NOTES

- When printing an album page, you should set up your Web browser as described below.
  - Select the browser frame where the images are located.
  - Set margins to the lowest possible values.
  - Set the background color to a printable color.
- See the user documentation that came with your Web browser application for details about printing and configuring settings for printing.

### 5. After you are finished viewing the album, exit your Web browser application.

### Saving an Album

- To save an album, copy the “DCIM” folder from camera memory or the memory card to your computer’s hard disk, a CD-R, an MO disk, or some other storage medium. Note that copying only the “ALBUM” folder, does not copy image data and other necessary files.
- After copying the “DCIM” folder, do not change or delete any of the files inside of it. Adding new images or deleting existing images may lead to abnormal album display.
- If you plan to use a memory card again after saving its album, first delete all of its files or format it before loading it into the camera.
- When you have “WEB” selected for the “Use” setting, the album shows only the smaller image files stored in the “ALBUM” folder. Such images can be uploaded to the Internet more quickly.

### Installing the Software from the CD-ROM

#### About the bundled CD-ROM

The CD-ROM that comes bundled with the camera contains the applications described below. Installation of these applications is optional, and you should install only the ones you want to use.

#### USB Driver for Mass Storage (for Windows/Macintosh)

This is the software that makes it possible for the camera to “talk” to your personal computer over a USB connection. If you are using Windows XP, Mac OS 9, or Mac OS X, do not install the USB driver from the CD-ROM. With these operating systems, you will be able to perform USB communication simply by connecting the camera to your computer with the USB cable.

#### Photo Loader (for Windows/Macintosh)

This application loads image data saved in JPEG and AVI format from a digital camera to your computer.

#### Photohands (for Windows)

This application is for retouching and printing image files.

### Internet Explorer (for Macintosh)

This is a browser application for reading HTML files. Images loaded by Photo Loader are stored in folders called “Libraries”. Internet Explorer displays the contents of a library on your computer screen.

### DirectX (for Windows)

This software provides an extended tool set including a codec that allows Windows 98 and 2000 to handle movie files recorded using a digital camera. You do not need to install DirectX if you are running Windows XP or Me.

### Acrobat Reader (for Windows/Macintosh)

This is an application that lets you read PDF files. Use it to read the user documentation for the camera, Photo Loader, and Photohands, all of which is included on the bundled CD-ROM.

### NOTE

- See the user documentation files (PDF) on the bundled CD-ROM for details about using Photo Loader and Photohands. See “Viewing User Documentation (PDF files)” on page 150 (Windows) and page 152 (Macintosh) of this manual for more information.

## Computer System Requirements

Computer system requirements depend on each of the applications, as described below.

### Windows

See the “Readme” file on the bundled CD-ROM.

### Macintosh

See the “readme” file on the bundled CD-ROM.

### Installing Software from the CD-ROM in Windows

Use the procedures in this section to install the software from the bundled CD-ROM to your computer.

#### NOTE

- If you already have one of the bundled applications installed on your computer, check its version. If the bundled version is newer than the one you have, you should install the newer version.

The CD-ROM includes the software and user documentation for various languages. Check the CD-ROM menu screen to see if applications and user documentation are available for a particular language.

### Getting Started

Start up your computer and insert the CD-ROM into its CD-ROM drive. This will automatically launch the menu application, which displays a menu screen on your computer.

- The menu application may not start up automatically on some computers. If this happens, navigate to the CD-ROM and double-click “menu.exe” to launch the menu application.

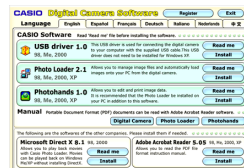

### Selecting a Language

First select a language. Note that some software is not available in all languages.

1. On the menu screen, click the tab for the language you want.

## Viewing the Contents of the “Read me” File

You should always read the “Read me” file for any application before installing it. The “Read me” file contains information you need to know when installing the application.

### 1. Click the “Read me” button for the application you are going to install.

#### »» IMPORTANT! ««

- Before upgrading or reinstalling Photo Loader, or before installing it onto another computer, be sure to read the “Read me” file for information about retaining existing libraries.

## Installing an Application

1. Click the “Install” button for the application you want to install.
2. Follow the instructions that appear on your computer screen.

#### »» IMPORTANT! ««

- Be sure to follow the instructions carefully and completely. If you make a mistake when installing Photo Loader, you may not be able to browse your existing library information and HTML files that are created automatically by Photo Loader. In some cases, image files may be lost.
- When using an operating system other than Windows XP, never connect the camera to your computer without installing the USB driver from the CD-ROM first.



## Viewing User Documentation (PDF Files)

1. In the “Manual” area, click the name of the manual you want to read.

### »» IMPORTANT! ««

- You need to have Adobe Acrobat Reader installed on your computer to read user documentation files. If you do not already have Adobe Acrobat Reader installed, you can install it from the bundled CD-ROM.

## User Registration

You can perform user registration over the Internet. To do so, of course, you need to be able to connect to the Internet with your computer.

1. Click the “Register” button.

- This starts up your Web browser and accesses the user registration website. Follow the instructions that appear on your computer screen to register.

2. After registering, terminate your connection to the Internet.

## Exiting the Menu Application

1. On the menu screen, click “Exit” to exit the menu.

### Installing Software from the CD-ROM on a Macintosh

The CD-ROM contains applications and user documentation in various languages in folders named for each language: English, French, German, Spanish, Italian, Dutch, and Chinese. Check the CD-ROM folders to find out if applications and user documentation are available in a particular language.

File names include one of the following codes that indicate the language of the data contained in the file as shown below.

English: e, French: f, German: g, Spanish: sp, Italian: i, Dutch: du, Chinese: ct

If your language is not included in the above, use the contents of the “English” folder.

### Installing Software

Use the following procedures to install the software. We recommend that you install Internet Explorer and Outlook Express first before installing Photo Loader and Acrobat Reader.

#### ■ To install Internet Explorer and Outlook Express

1. Open the file named “Internet Explorer”.
2. Open the folder for the language version you want to install, and then open the file named “readme\_casio” file.
3. Follow the instructions in the read me file to install Internet Explorer and Outlook Express.

#### ■ To install Photo Loader

1. Open the folder named “Photo Loader”.
2. Open the folder named “English”, and then open the file named “Important”.
3. Open the folder named “Installer”, and then open the file named “readme”.
4. Follow the instructions in the “readme” file to install Photo Loader.

### »» IMPORTANT! ««

- If you are upgrading to the new version of Photo Loader from a previous version and you want to use library management data and HTML files created using the old version of Photo Loader, be sure to read the “Important” file in the “Photo Loader” folder. Follow the instructions in the file to use your existing library management files. Failure to follow this procedure correctly can result in loss or corruption of your existing files.

### ■ To install Acrobat Reader

1. On the bundled CD-ROM, open the folder named “Acrobat Reader”.
2. Open the folder for the language whose version of Acrobat Reader you want to install, and then open the file named “readme\_casio”.
  - Follow the instructions in the read me file to install Acrobat Reader.

### Viewing User Documentation (PDF Files)

To perform the following procedures, you must have Acrobat Reader installed on your Macintosh.

1. On the bundled CD-ROM, open the folder named “Acrobat Reader”.
2. Open the folder for the language whose version of Acrobat Reader you want to install, and then open the file named “readme\_casio”.
3. Follow the instructions in the read me file to install Acrobat Reader.

■ **To view the camera user's guide**

1. On the CD-ROM, open the "Manual" folder.
2. Open the "Digital Camera" folder, and then open the folder for the language whose user's guide you want to view.
3. Open the file named "camera\_xx.pdf".
4. "xx" is the language code (English: e, French: f, German: g, Spanish: sp, Italian: i, Dutch: du, Chinese: ct).

■ **To read the Photo Loader user's guide**

1. On the CD-ROM, open the "Manual" folder.
2. Open the "Photo Loader" folder and then open the "English" folder.
3. Open "PhotoLoader\_english".

■ **To register as a user**

Internet registration only is supported. Visit the following CASIO website to register:

<http://world.casio.com/qv/register/>

# APPENDIX







## Menu Reference

The following shows lists of menus that appear in the REC mode and PLAY mode, and their settings.

- The settings that are underlined in the following table are initial defaults.

### ■ REC mode

#### ● REC tab menu

REC Mode	 (Snapshot) /  (Best Shot) /  (Movie)
Self-timer	10 sec / 2 sec / X3 / <u>Off</u>
Size	<u>2048 x 1536</u> / 1600 x 1200 / 1280 x 960 / 640 x 480
Quality	Fine / <u>Normal</u> / Economy
EV Shift	-2.0 / -1.7 / -1.3 / -1.0 / -0.7 / -0.3 / <u>0.0</u> / +0.3 / +0.7 / +1.0 / +1.3 / +1.7 / +2.0
White Balance	<u>Auto</u> /  (Sunlight) /  (Shade) /  (Light Bulb) /  (Fluorescent) / Manual
ISO	<u>Auto</u> / ISO 50 / ISO 100 / ISO 200
Digital Zoom	<u>On</u> / Off
Review	<u>On</u> / Off
L/R Key	<u>REC Mode</u> / EV shift / White Balance / ISO / Self-timer / Off

#### ● Memory tab menu

REC Mode	<u>On</u> / Off
Flash	<u>On</u> / Off
Focus	On / <u>Off</u>
White Balance	On / <u>Off</u>
ISO	On / <u>Off</u>
Digital Zoom	<u>On</u> / Off
MF Position	On / <u>Off</u>

## ● Set Up tab menu

Beep	<u>On</u> / Off
Startup	On (Selectable image) / <u>Off</u>
File No.	<u>Continue</u> / Reset
World Time	<u>Home</u> / World
	Home time setup (city, DST, etc.)
	World Time setup (city, DST, etc.)
Date Style	YY/MM/DD / DD/MM/YY / MM/DD/YY
Adjust	Time setting
Language	日本語 / English / Français / Deutsch / Español / Italiano / Português / 中國語 / 中国語 / 한국어
Sleep	30 sec / <u>1 min</u> / 2 min / Off
Auto Power Off	<u>2 min</u> / 5 min
Format	Format / <u>Cancel</u>
Reset	Reset / <u>Cancel</u>

## ■ PLAY mode

## ● PLAY tab menu

Slideshow	<u>Start</u> / Images / Time / Interval
Calender	–
Favorites	<u>Show</u> / Save / Delete / Cancel
DPOF	<u>Select images</u> / All images / Cancel
Protect	<u>On</u> / All Files : On / Cancel
Rotation	<u>Rotate</u> / Cancel
Resize	<u>1280 x 960</u> / 640 x 480 / Cancel
Trimming	–
Alarm	Alarm setups
Copy	<u>Built-in</u> → Card / Card → Built-in / Cancel

## ● Set Up tab menu

Beep	<u>On</u> / Off
Startup	On (Selectable image) / <u>Off</u>
File No.	<u>Continue</u> / Reset
World Time	<u>Home</u> / World
	Home time setup (city, DST, etc.)
	World Time setup (city, DST, etc.)
Date Style	YY/MM/DD / DD/MM/YY / MM/DD/YY
Adjust	Time setting
Language	日本語 / English / Français / Deutsch / Español / Italiano / Português / 中國語 / 中国語 / 한국어
Sleep	30 sec / <u>1 min</u> / 2 min / Off
Auto Power Off	<u>2 min</u> / 5 min
Format	Format / <u>Cancel</u>
Reset	Reset / <u>Cancel</u>

## Indicator Lamp Reference

The camera has three indicator lamps: a green operation lamp, a red operation lamp, and a self-timer lamp. These lamps light and flash to indicate the current operational status of the camera.

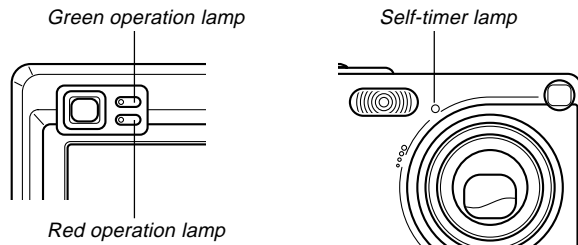

\* There are three lamp flash patterns. Pattern 1 flashes once per second, Pattern 2 flashes twice per second, and Pattern 3 flashes four times per second. The table below explains what each flash pattern indicates.

## REC mode

Operation Lamp		Self-timer Lamp	Meaning
Green	Red	Red	
Lit			Operational (Power on, recording enabled)
	Pattern 3		Flash is charging.
	Lit		Flash charging is complete.
Lit			Auto Focus operation was successful.
Pattern 3			Cannot Auto Focus.
Lit			Monitor screen is off.
Pattern 2			Storing image
Pattern 1			Storing movie
		Pattern 1	Self-timer countdown (10 to 3 seconds)
		Pattern 2	Self-timer countdown (3 to 0 seconds)
	Pattern 1		Cannot charge flash.
	Pattern 2		Memory card problem / Memory card is unformatted. / Best Shot setup cannot be registered.
	Lit		Memory card is locked. / Cannot create folder. / Memory is full. / Write error

Operation Lamp		Self-timer Lamp	Meaning
Green	Red	Red	
	Pattern 3		Low battery alert
Pattern 3			Formatting card
Pattern 3			Powering down

▶▶▶ IMPORTANT! ◀◀◀

- When you are using a memory card, never remove the card from the camera while the green operation lamp is flashing. Doing so will cause recorded images to be lost.



## PLAY mode

Operation Lamp		Self-timer Lamp	Meaning
Green	Red	Red	
Lit			Operational (Power on, recording enabled)
Pattern 3			One of the following operations is being performed: delete, DPOF, image protect, copy, album creation, format, power down
	Pattern 2		Memory card problem / Memory card is unformatted.
	Lit		Memory card is locked. / Cannot create folder. / Memory is full.
	Pattern 3		Low battery alert

## USB Cradle Indicator Lamps

The USB cradle has two indicator lamps: a [CHARGE] lamp and a [USB] lamp. These lamps light and flash to indicate the current operational status of the USB cradle and camera.

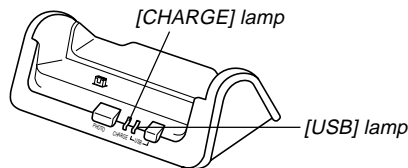

[CHARGE] lamp		[USB] lamp		Meaning
Color	Status	Color	Status	
Red	Lit			Charging
Green	Lit			Charging complete
Amber	Lit			Charge standby
Red	Flashing			Charge error
		Green	Lit	USB connection
		Green	Flashing	Accessing memory

## Troubleshooting Guide

	Symptom	Possible Cause	Action
Power Supply	Power does not turn on.	<ol style="list-style-type: none"> <li>1) The battery is not oriented correctly.</li> <li>2) The battery is dead.</li> </ol>	<ol style="list-style-type: none"> <li>1) Orient the battery correctly (page 25).</li> <li>2) Charge the battery (page 27). If the battery goes dead soon after being charged, it means the battery has reached the end of its life and needs to be replaced. Purchase a separately available NP-20 rechargeable lithium ion battery.</li> </ol>
	Camera suddenly powers down.	<ol style="list-style-type: none"> <li>1) Auto Power Off activated (page 36).</li> <li>2) The battery is dead.</li> </ol>	<ol style="list-style-type: none"> <li>1) Turn power back on.</li> <li>2) Charge the battery (page 27).</li> </ol>
Image Recording	Image is not recorded when the shutter release button is pressed.	<ol style="list-style-type: none"> <li>1) The mode selector is set to "PLAY".</li> <li>2) Flash unit is being charged.</li> <li>3) Memory is full.</li> </ol>	<ol style="list-style-type: none"> <li>1) Align the mode selector with "REC".</li> <li>2) Wait until the flash unit finishes charging.</li> <li>3) Transfer files you want to keep to your computer and then delete files from image memory, or use a different memory card.</li> </ol>
	Auto Focus does not focus properly	<ol style="list-style-type: none"> <li>1) The lens is dirty.</li> <li>2) The subject is not located in the center of the focus frame when you compose the image.</li> <li>3) The subject you are shooting is a type that is not compatible with Auto Focus operation (page 57).</li> <li>4) You are moving the camera.</li> </ol>	<ol style="list-style-type: none"> <li>1) Clean the lens.</li> <li>2) Make sure the subject is centered in the focus frame when composing the image.</li> <li>3) Use manual focus (page 59).</li> <li>4) Mount the camera on a tripod.</li> </ol>

## APPENDIX

	Symptom	Possible Cause	Action
Image Recording	The subject is out of focus in the recorded image.	The image is not focused properly.	When composing the image, make sure the subject on which you want to focus is located inside the focus frame.
	Camera powers down during self-timer countdown.	The battery is dead.	Charge the battery (page 27).
	Monitor screen image is out of focus.	<ol style="list-style-type: none"> <li>1) You are using the Manual Focus Mode and have not focused the image.</li> <li>2) You are trying to use the Macro Mode when shooting a scenery or portrait shot.</li> <li>3) You are trying to use Auto Focus or the Infinity Mode (<math>\infty</math>) when shooting a close-up shot.</li> </ol>	<ol style="list-style-type: none"> <li>1) Focus the image (page 59).</li> <li>2) Use Auto Focus for scenery and portrait shots.</li> <li>3) Use the Macro Mode for close-ups.</li> </ol>
	Recorded images are not saved in memory.	<ol style="list-style-type: none"> <li>1) Camera powers down before the save operation is complete.</li> <li>2) Removing the memory card before the save operation is complete.</li> </ol>	<ol style="list-style-type: none"> <li>1) When the battery indicator shows , charge the battery as soon as possible (page 27).</li> <li>2) Do not remove the memory card before the save operation is complete.</li> </ol>
Playback	Color of the playback image is different from the image on the monitor screen during recording.	Sunlight or light from another source is shining directly into the lens during recording.	Position the camera so sunlight does not shine directly into the lens.

## APPENDIX

	Symptom	Possible Cause	Action
Playback	Images are not displayed.	A memory card with non-DCF images recorded with another camera is loaded in the camera.	This camera cannot display non-DCF images recorded onto a memory card using another digital camera.
	All buttons and switches are disabled.	Circuit problem caused by electrostatic charge, impact, etc. while the camera was connected to another device.	Remove the battery from the camera, reinsert it, and then try again.
Other	Monitor screen is off.	<ol style="list-style-type: none"> <li>1) USB communication is in progress.</li> <li>2) The monitor screen is turned off (in a recording mode).</li> </ol>	<ol style="list-style-type: none"> <li>1) After the computer stops accessing camera file memory, press the [USB] button on the USB cradle. Check to make sure that the [USB] lamp on the USB cradle is off, and then remove the camera from the USB cradle.</li> <li>2) Press [DISP] to turn on the monitor screen.</li> </ol>
	Cannot transfer files over a USB connection.	<ol style="list-style-type: none"> <li>1) Camera is not set securely on the USB cradle.</li> <li>2) USB cable is not connected securely.</li> <li>3) USB driver is not installed.</li> <li>4) Camera is turned off.</li> </ol>	<ol style="list-style-type: none"> <li>1) Check the connection between the camera and USB cradle.</li> <li>2) Check all connections.</li> <li>3) Install the USB driver on your computer (page 124).</li> <li>4) Press the [USB] button on the USB cradle.</li> </ol>

## Display Messages

<b>Battery is low.</b>	The battery is dead.
<b>BEST SHOT memory is full.</b>	You are attempting to register a Best Shot setup when the "SCENE" folder already contains 999 setups.
<b>Card ERROR</b>	Some problem occurred with the memory card. Turn off the camera, and remove and then reinsert the memory card. If the same message appears, format the memory card (page 120).  <b>»» IMPORTANT! ««</b> Formatting the memory card deletes all files on the memory card. Before formatting, try transferring recoverable files to a computer or some other storage device.
<b>File could not be saved because battery is low.</b>	The battery is dead, so the recorded image could not be saved.
<b>Folder cannot be created.</b>	This message appears when you try to record an image while there are 9,999 files stored in the 999th folder. If you want to record more files, delete files you no longer need (page 94).
<b>Memory Full</b>	Memory is full. If you want to record more files, delete files you no longer need (page 94).

<b>Printing Error</b>	One of the following problems occurred during printing. <ul style="list-style-type: none"> <li>• Printer power off</li> <li>• Out of paper</li> <li>• Out of ink</li> <li>• Printer internal error</li> </ul>
<b>Record Error</b>	Image compression could not be performed during image data storage for some reason. Record the image again.
<b>SYSTEM ERROR</b>	Your camera system is corrupted. Contact your retailer or a CASIO service center.
<b>The card is locked.</b>	The LOCK switch of the SD memory card is locked. You cannot store images to or delete images from a memory card that is locked.
<b>The card is not formatted.</b>	The memory card is not formatted. Format the memory card (page 120).
<b>The function is not supported for this file.</b>	The function you are trying to perform is not supported for the file on which you are trying to perform it.
<b>There are no files.</b>	There are no files in built-in memory or on the memory card.

<b>There are no printing images.</b>	There are no DPOF settings specifying images and the number of copies of each for printing.
<b>Set up DPOF.</b>	Configure the required DPOF settings (page 98).
<b>This file cannot be played.</b>	The image file or audio file is corrupted, or is a type that cannot be displayed by this camera.
<b>This function cannot be used.</b>	You attempted to copy files from built-in memory to a memory card while there is no memory card loaded in the camera (page 122).
<b>Can not find the file.</b>	The camera cannot find the image specified by the slideshow "Images" setting. Specify another image (page 88).

## Specifications

### Main Specifications

**Product:** ..... Digital Camera

**Model:** ..... EX-Z3

### ■ Camera Functions

#### Image Files Format

Snapshots: ..... JPEG (Exif Ver.2.2); DCF (Design rule for Camera File system) 1.0 standard; DPOF compliant

Movies: ..... AVI (Motion JPEG)

**Recording Media:** ..... 10MB built-in Flash memory  
SD Memory Card  
Multimedia Card

#### Image Size

Snapshots: ..... 2048 x 1536 pixels  
1600 x 1200 pixels  
1280 x 960 pixels

640 x 480 pixels  
Movies: ..... 320 x 240 pixels

## APPENDIX

### Approximate Memory Capacity and File sizes:

#### • Snapshots

File Size (pixels)	Quality	Approximate Image File Size	Built-in flash memory 10MB	SD Memory Card* 64MB
2048 x 1536	Fine	1.6MB	5 shots	34 shots
	Normal	1.2MB	7 shots	45 shots
	Economy	630KB	14 shots	88 shots
1600 x 1200 (UXGA)	Fine	1050KB	8 shots	53 shots
	Normal	710KB	12 shots	79 shots
	Economy	370KB	24 shots	154 shots
1280 x 960 (SXGA)	Fine	680KB	13 shots	82 shots
	Normal	460KB	20 shots	126 shots
	Economy	250KB	35 shots	221 shots
640 x 480 (VGA)	Fine	190KB	46 shots	294 shots
	Normal	140KB	61 shots	386 shots
	Economy	90KB	98 shots	618 shots

#### • Movies (320 x 240 pixels)

Data Size	130KB/second max.
Recording Time	One Movie: 30 seconds maximum Total Movie Time: 80 seconds maximum (built-in memory) 500 seconds maximum (SD 64MB memory card)*

\* Based on Matsushita Electric Industrial Co., Ltd. products. Capacity depends on card manufacturer.

\* To determine the number of images that can be stored on a memory card of a different capacity, multiply the capacities in the table by the appropriate value.

**Delete:** ..... Single-file, all files (with protection)

**Effective Pixels** ..... 3.20 million

**Imaging Element** ..... 1/2.5-inch square pixel color CCD  
(Total pixels: 3.34 million)

**Lens/Focal Distance** ..... F2.6 (W) to 4.8 (T); f=5.8 (W) to 17.4mm (T) (equivalent to approximately 35 (W) to 105 (T) for 35mm film)

**Zoom:** ..... 3X optical zoom; 4X digital zoom  
(12X in combination with optical zoom)

**Focusing:** ..... Contrast-type Auto Focus (Macro Mode, Infinity Mode); focus lock; manual focus

#### Approximate Focus Range (from lens surface)

Normal: ..... 40cm to ∞ (1.3' to ∞)

Macro: ..... 6cm to 50cm (2.4" to 19.7")

In the Macro mode, the optical zoom range is 1x to 1.8x.

#### Exposure Control

Light Metering: ..... Multi-pattern by CCD

Exposure: ..... Program AE

Exposure Compensation: ... -2EV to +2EV (1/3EV units)

**Shutter:** ..... CCD electronic shutter; mechanical shutter, 1 to 1/2000 second  
(Depends on REC mode and ISO sensitivity setting being used.)

## APPENDIX

**Aperture:** ..... F2.6/4.3, auto switching  
**White Balance:** ..... Automatic, fixed (4 modes), manual switching  
**Self-timer:** ..... 10 seconds, 2 seconds, Triple Self-timer

### Built-in Flash

Flash Modes: ..... AUTO, ON, OFF, Red eye reduction  
Flash Range: ..... Wide Angle Optical Zoom: 0.4 to 2.3 meters (1.3' to 7.5')  
Telephoto Optical Zoom: 0.4 to 1.5 meters (1.3' to 4.9')  
(ISO Sensitivity: "Auto")

**Recording Functions:** ..... Snapshot; Best Shot; Movie

**Monitor Screen:** ..... 2.0-inch TFT color LCD  
84,960 pixels (354 x 240)

**Viewfinder:** ..... Monitor screen and optical viewfinder

**Timekeeping Functions** .... Built-in digital quartz clock  
Date and Time: ..... Recorded with image data  
Auto Calendar: ..... To 2049

**World Time:** ..... City; Date; Time; Summer time;  
162 cities in 32 time zones

**Input/Output Terminals:** ... Cradle connector

## ■ Power Requirements

**Power Requirements:** ..... Rechargeable lithium ion battery (NP-20) x 1

### Approximate Battery Life:

Continuous Recording (Continuous Snapshot Recording)	75 minutes (450 shots)
Continuous Playback	120 minutes

The values noted above are approximate values until power fails at normal temperature (25°C (77°F)). The above does not guarantee that you will be able to achieve this level of operation. Low temperatures shorten battery life (page 30).

**Power Consumption:** ..... DC 3.7V Approximately 3.5W

**Dimensions:** ..... 87(W) x 57(H) x 22.9(D) mm  
(3.4"(W) x 2.2"(H) x 0.9"(D))  
(excluding projections)

**Weight:** ..... Approximately 126 g (4.5 oz)  
(excluding battery and accessories)

**Bundled Accessories:** ..... Rechargeable lithium ion battery (NP-20); USB cradle (CA-21); Special AC adaptor; USB cable; Strap; CD-ROM; Basic Reference



### ■ Rechargeable Lithium Ion Battery (NP-20)

**Rated Voltage:** ..... 3.7 V

**Rated Capacitance:** ..... 680 mAh

#### Operating Temperature

**Range:** ..... 0°C to 40°C (32°F to 104°F)

**Dimensions:** ..... 33 (W) x 50 (H) x 4.7 (D) mm  
(1.3" (W) x 2.0" (H) x 0.19" (D))

**Weight:** ..... Approximately 16 g (0.56 oz)

### ■ USB Cradle

**Input/Output Terminals** .... Camera connector; USB port; AC adaptor terminal (DC IN 5.3V)

**Power Consumption** ..... DC 5.3V Approximately 3.4W

**Dimensions** ..... 106(W) x 42(H) x 59.5(D) mm  
(4.2"(W) x 1.7"(H) x 2.3"(D))  
(excluding projections)

**Weight** ..... Approximately 63 g (2.2 oz)

### ■ Special AC Adaptor (Inlet Type)

**Power Requirement** ..... 100 to 240V AC, 50/60Hz, 0.12A

**Output** ..... 5.3V DC, 1.0A

**Dimensions** ..... 48(W) x 28(H) x 66(D) mm  
(1.9"(W) x 1.1"(H) x 2.6"(D))  
(excluding projections and cable)

**Weight** ..... Approximately 120 g (4.2 oz)

### ■ Special AC Adaptor (Plug-in Type)

**Power Requirement** ..... 100 to 240V AC, 50/60Hz, 0.12A

**Output** ..... 5.3V DC, 1.0A

**Dimensions** ..... 47(W) x 20(H) x 72(D) mm  
(1.9"(W) x 0.8"(H) x 2.8"(D))  
(excluding projections and cable)

**Weight** ..... Approximately 110 g (3.9 oz)

### Power Supply

- Use only the special NP-20 rechargeable lithium ion battery to power this camera. Use of any other type of battery is not supported.
- This camera does not have a separate battery for the clock. The date and time settings of the camera are cleared whenever power is totally cut off (from both the battery and USB cradle). Be sure to reconfigure these settings after power is interrupted (page 39).

### LCD Panel

- The LCD panel is a product of the latest LCD manufacturing technology that provides a pixel yield of 99.99%. This means that less than 0.01% of the total pixels are defective (they do not turn on or always remain turned on).